

LOC		DIST		REVISIONS			
ES		00		REV	DATE	BY	APPV
A23	ECR-17-013299			1	11SEP2017	WW	RR
A24	ECR-18-008274				30MAY2018	KD	FL
A25	ECR-19-012819				16AUG2019	SM	FL
B	ECR-21-100878				24MAR2021	KD	FL

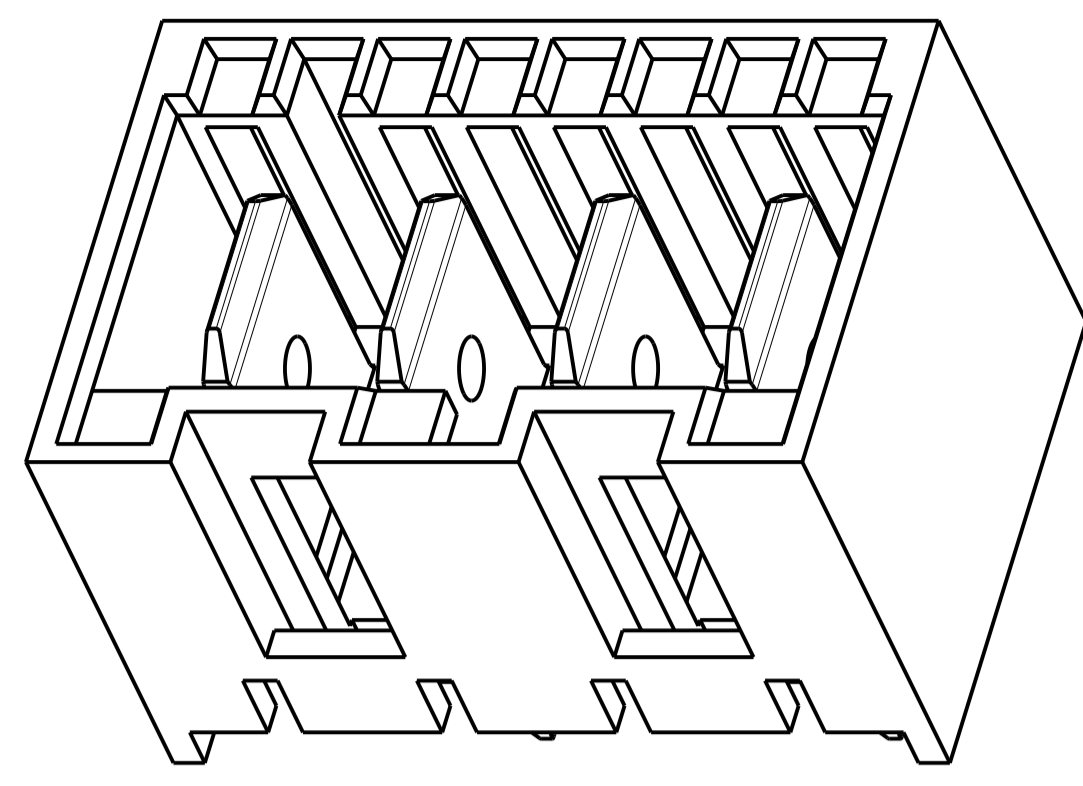

- NOTE**
- HOUSING HAS RAST 5 COMPLIANT KEYING, LATCHING, AND POLARIZATION. TAB IS 6.30 X 0.8 ACCORDING TO DIN 46244
 - SEE SHEET 2 FOR AVAILABLE CONFIGURATIONS
 - MATERIAL: HOUSING, NYLON, UL94 V0, 750°C GWT NO FLAME. CONTACT, COPPER ALLOY, 0.8MM THICK
 - FINISH: CONTACTS, MATT TIN PLATING OVERALL, NICKEL UNDER-PLATING. BRIGHT TIN PLATING OVERALL, NICKEL UNDER-PLATING. SILVER PLATING OVERALL, NICKEL UNDER-PLATING
- ⚠ PCB TABS INSERTED IN A STAGGERED PATTERN BEGINNING WITH POSITION 1 (Cct1)
- ⚠ THE PART NUMBERS SHOWING IN SHEET 2 & 3 & 4 & 5 ARE FOR NATURAL COLOR. THE PART NUMBER FOR OTHER COLOR ARE BASED ON THE NATURAL ONE: FOR THE SAME CONFIGURATION, THE PREFIX AND POSTFIX OF THE P/N ARE THE SAME, ONLY THE BASE NUMBER IS DIFFERENT ACCORDING TO DIFFERENT COLOR, DETAIL PLEASE SEE SHEET 6
- 7 PACKAGING: LOOSE PIECE OR TUBE. THE PART NUMBERS IN THIS DRAWING ARE WITH LOOSE PIECE PACKAGING. PLEASE CONTACT TE SALES REPRESENTATIVES FOR TUBE PACKAGING REQUIREMENT.
- ⚠ PRELIMINARY PART, NOT RELEASED FOR PRODUCTION.
- 9 FOR P/N: 2-1971895-4:
 1) THE CONTACTS ARE WITH BRIGHT TIN PLATING
 2) INSERTION FORCE MATING WITH 4P MONO SHAPE MKI CONNECTOR: 85N MAX ACCORDING TO IEC 60512-13-1, Test 13a.
- 10 FOR P/N: 5-1971845-8, 2-1971845-6, 6-1971845-5 AND 2-1971895-5:
 1) THE CONTACTS ARE WITH BRIGHT TIN PLATING.
- ⚠ PART NUMBERS WITH TUBE PACKAGING

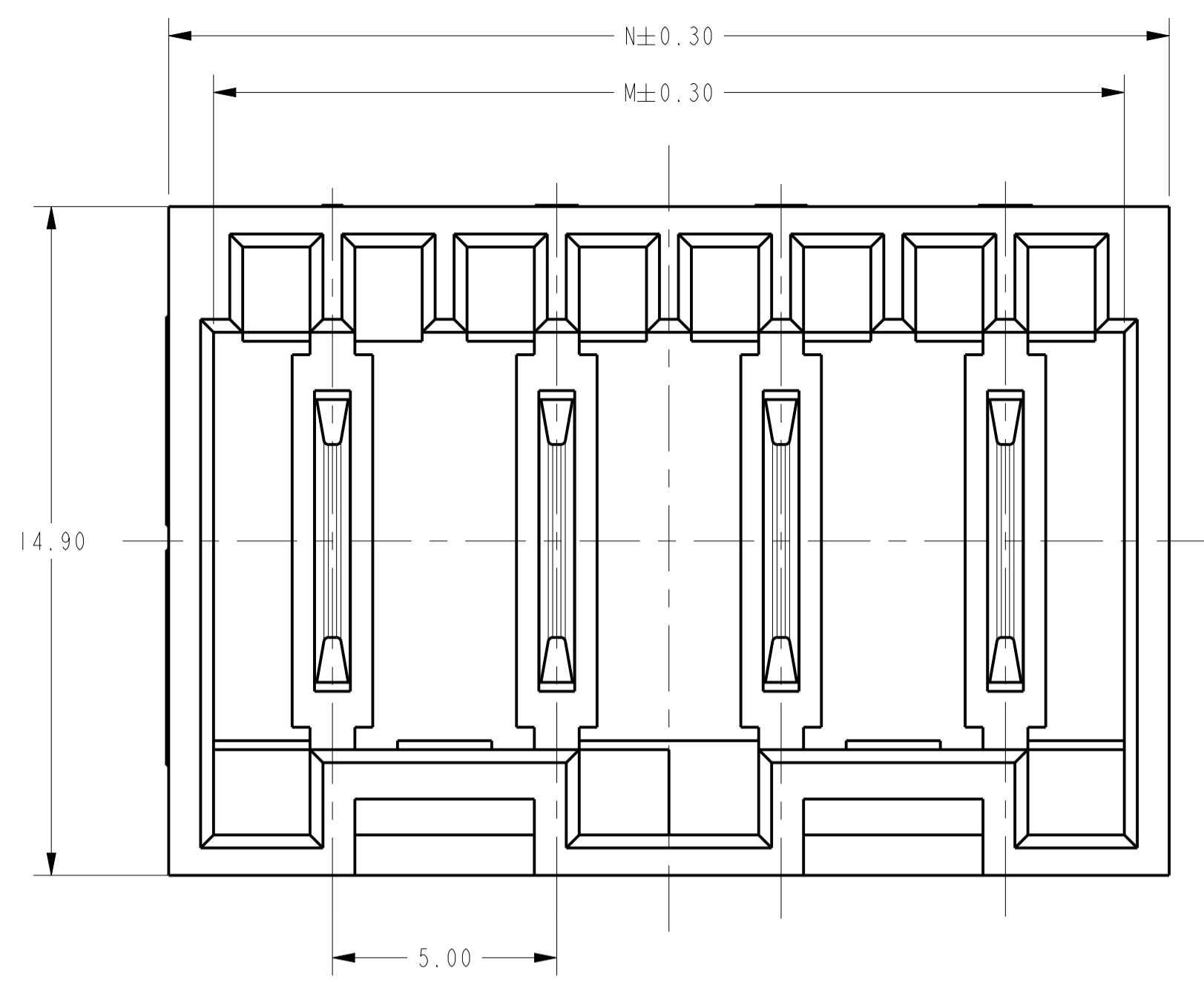
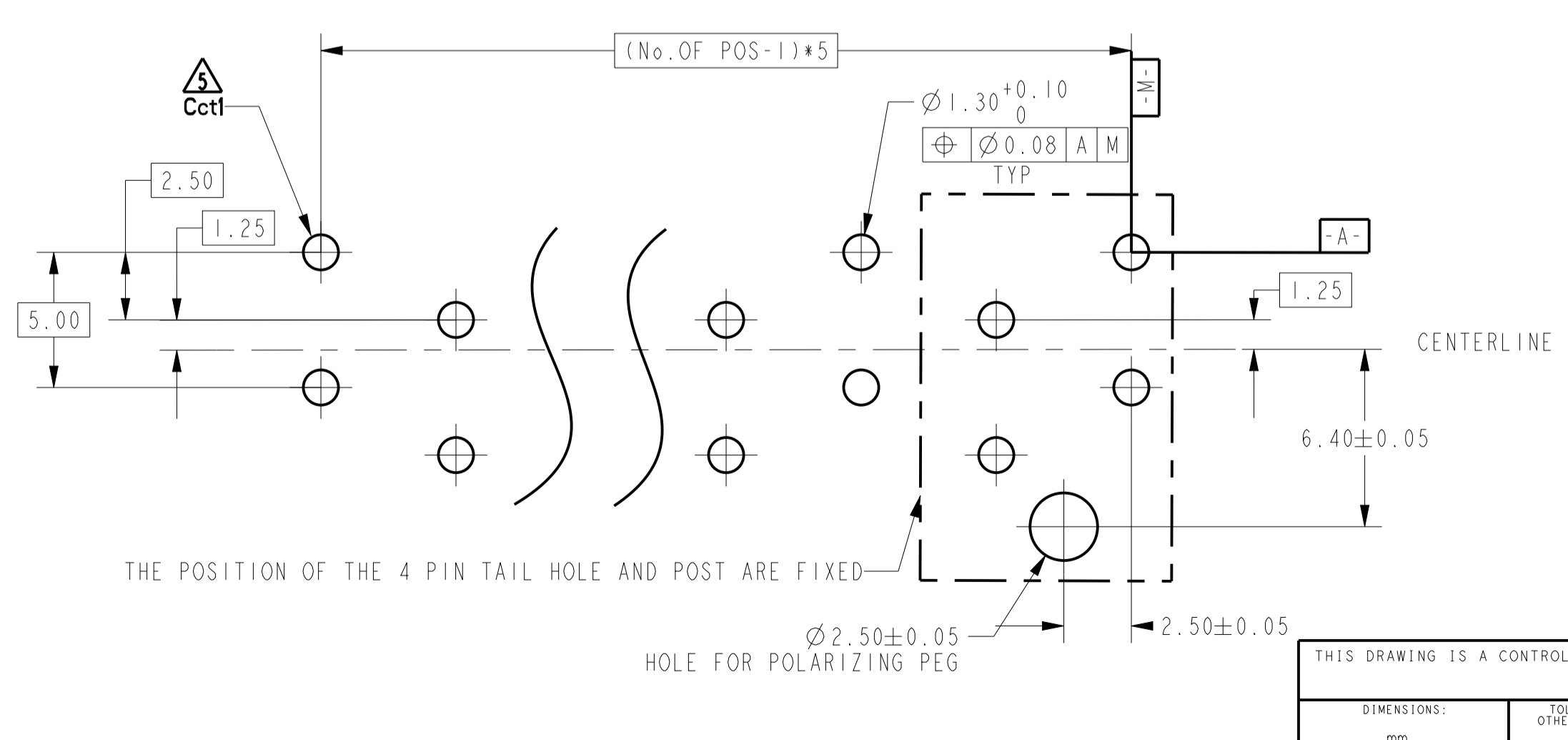
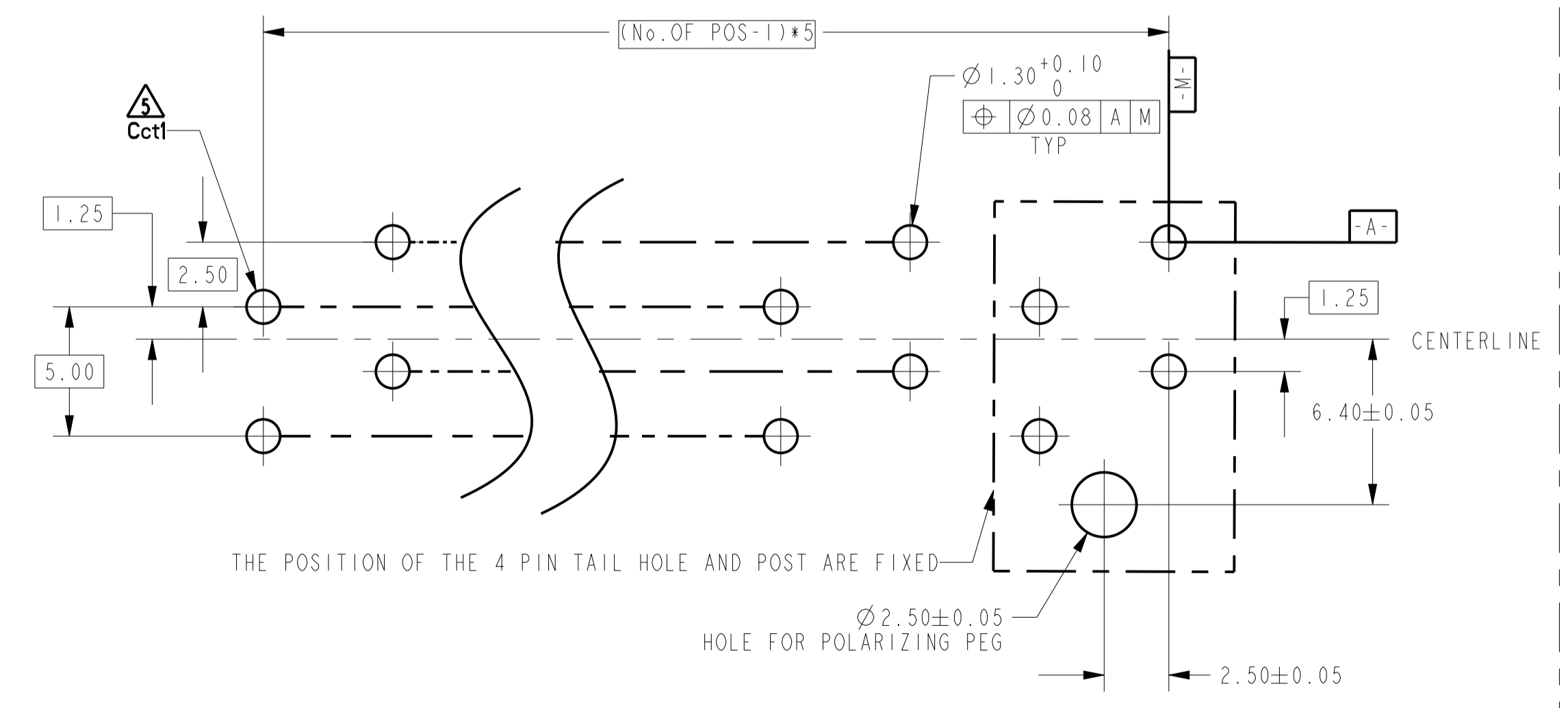
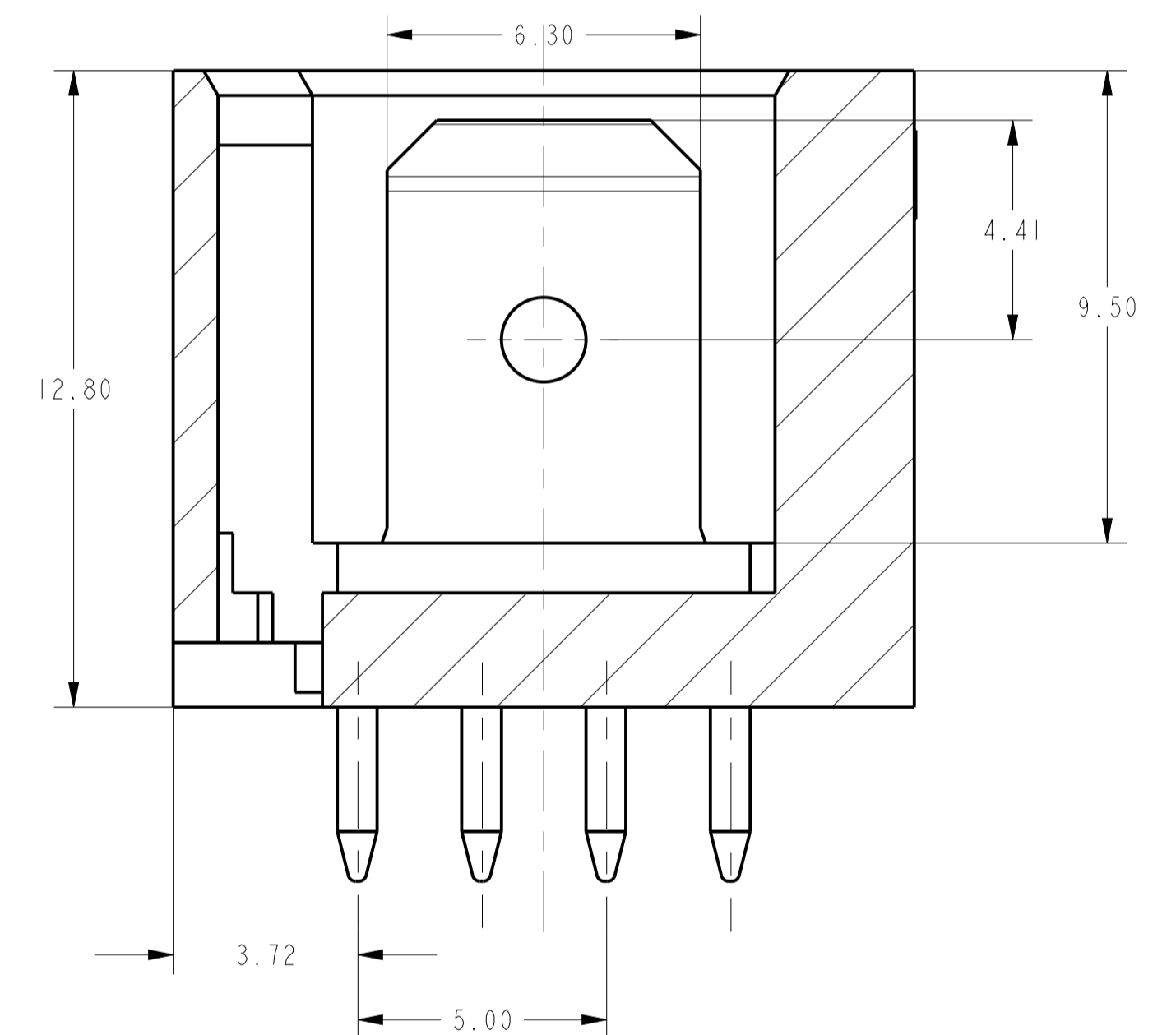
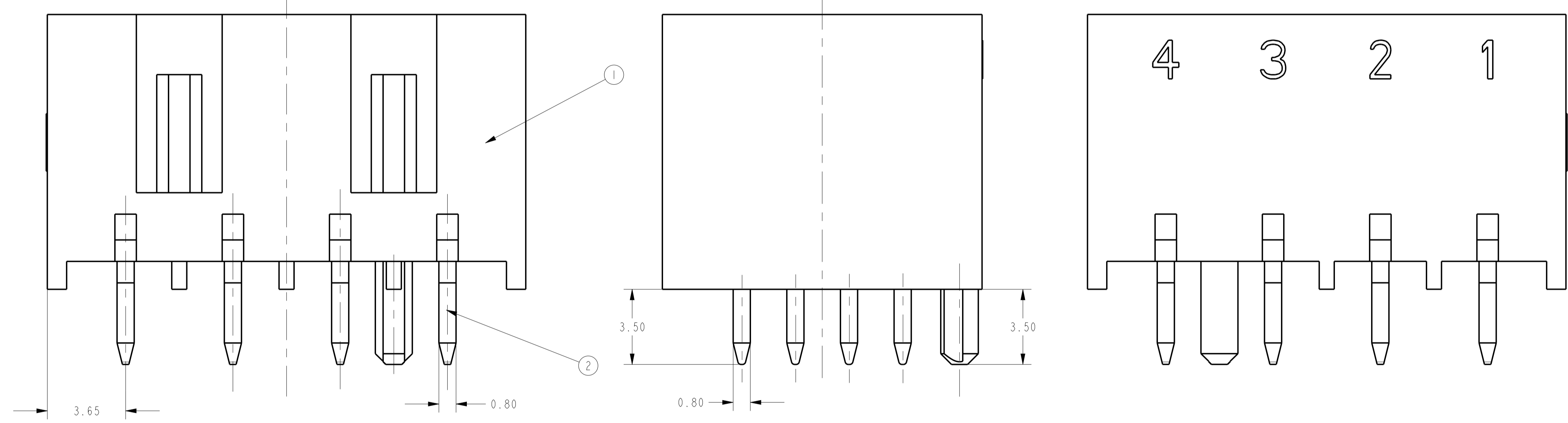

42.30	40.30	8
37.30	35.30	7
32.30	30.30	6
27.30	25.30	5
22.30	20.30	4
17.30	15.30	3
12.30	10.30	2
N	M	NO. OF POS.

RECOMMEND PCB LAYOUT - SOLDER SIDE
 EVEN NUMBER OF PINS
 PCB 15±0.2 THICK

RECOMMEND PCB LAYOUT - SOLDER SIDE
 ODD NUMBER OF PINS
 PCB 15±0.2 THICK

THIS DRAWING IS A CONTROLLED DOCUMENT.

DIMENSIONS:	TOLERANCES UNLESS OTHERWISE SPECIFIED:	OWN: HRP 21Jan2013	NAME: RAST 5 TAB HEADER ASSY
mm	0 PLC ±	CHK: HAPYE 21Jan2013	DIN STYLE, TH, VERTICAL
	1 PLC ±	APPV: YHM 21Jan2013	108-106080
	2 PLC ±0.25	PRODUCT SPEC	
	3 PLC ±	APPLICATION SPEC	
	4 PLC ±	SIZE: A1	00779
	5 PLC ±	SCALE: 8:1	1971845
	ANGLES ±	Customer Drawing	

Customer Drawing

LOC		DIST		REVISIONS			
P	LTN	DESCRIPTION	DATE	OWN	APVD		
-	-	SEE SHEET 1	-	-	-	-	-

color	QTY	②	QTY	①	NO. OF POS.	TE PART NO.		
NATURAL	8	TAB CONTACT MATT TIN PLATING (5-1971845-8, 6-1971845-5, 2-1971845-6 AND 2-1971895-5 WITH BRIGHT TIN)	1	8	8	6-1971845-8 5-1971845-8 Δ 4-1971845-8 3-1971845-8 2-1971845-8 1-1971845-8 1971845-8		
RED	7		1	7	7	1971946-7 1971895-7 9-1971845-7 8-1971845-7 7-1971845-7 6-1971845-7 5-1971845-7 4-1971845-7 3-1971845-7 2-1971845-7 1-1971845-7 1971845-7		
NATURAL			1	6	6	1-1971895-6 1971895-6 9-1971845-6 8-1971845-6 7-1971845-6 6-1971845-6 5-1971845-6 4-1971845-6 3-1971845-6 2-1971845-6 Δ 1-1971845-6 1971845-6		
BLUE			5	1	5	5	1971954-5 Δ 2-1971895-5 Δ 1-1971895-5 1971895-5 9-1971845-5 8-1971845-5 7-1971845-5 6-1971845-5 Δ 5-1971845-5 4-1971845-5 3-1971845-5 2-1971845-5 1-1971845-5 1971845-5	
NATURAL				1	4	4	1971845-5	
NATURAL				1	3	3	3	1971845-5
NATURAL				1	2	2	2	1971845-5
NATURAL				1	1	1	1	1971845-5
NATURAL				1	1	1	1	1971845-5
NATURAL			8	1	8	8	6-1971845-8 5-1971845-8 Δ 4-1971845-8 3-1971845-8 2-1971845-8 1-1971845-8 1971845-8	
NATURAL			8	1	8	8	6-1971845-8 5-1971845-8 Δ 4-1971845-8 3-1971845-8 2-1971845-8 1-1971845-8 1971845-8	
NATURAL	8		1	8	8	6-1971845-8 5-1971845-8 Δ 4-1971845-8 3-1971845-8 2-1971845-8 1-1971845-8 1971845-8		
NATURAL	8		1	8	8	6-1971845-8 5-1971845-8 Δ 4-1971845-8 3-1971845-8 2-1971845-8 1-1971845-8 1971845-8		
NATURAL	8		1	8	8	6-1971845-8 5-1971845-8 Δ 4-1971845-8 3-1971845-8 2-1971845-8 1-1971845-8 1971845-8		
NATURAL	8		1	8	8	6-1971845-8 5-1971845-8 Δ 4-1971845-8 3-1971845-8 2-1971845-8 1-1971845-8 1971845-8		
NATURAL	8		1	8	8	6-1971845-8 5-1971845-8 Δ 4-1971845-8 3-1971845-8 2-1971845-8 1-1971845-8 1971845-8		
NATURAL	8	1	8	8	6-1971845-8 5-1971845-8 Δ 4-1971845-8 3-1971845-8 2-1971845-8 1-1971845-8 1971845-8			
NATURAL	8	1	8	8	6-1971845-8 5-1971845-8 Δ 4-1971845-8 3-1971845-8 2-1971845-8 1-1971845-8 1971845-8			

color	QTY	②	QTY	①	NO. OF POS.	TE PART NO.
GREEN	4	TAB CONTACT w/ MATT TIN PLATING (2-1971895-4 IS WITH BRIGHT TIN)	1	4	4	1971962-4 2298030-4 9-1971895-4 8-1971895-4 Δ 7-1971895-4 6-1971895-4 5-1971895-4 4-1971895-4 3-1971895-4 2-1971895-4 Δ 1-1971895-4 1971895-4 Δ 9-2304591-4 9-1971845-4 8-1971845-4 7-1971845-4 6-1971845-4 5-1971845-4 4-1971845-4 3-1971845-4 2-1971845-4 1-1971845-4 1971845-4
natural	3		1	3	3	5-1971895-3 4-1971895-3 3-1971895-3 2-1971895-3 1-1971895-3 1971895-3 9-1971845-3 8-1971845-3 7-1971845-3 6-1971845-3 5-1971845-3 4-1971845-3 3-1971845-3 2-1971845-3 1-1971845-3 1971845-3
natural	2		1	2	2	7-1971895-2 6-1971895-2 5-1971895-2 4-1971895-2 3-1971895-2 2-1971895-2 1-1971895-2 1971895-2 9-1971845-2 8-1971845-2 7-1971845-2 6-1971845-2 5-1971845-2 4-1971845-2 3-1971845-2 2-1971845-2 1-1971845-2 1971845-2
natural	4		1	4	4	1971845-2
natural	4		1	4	4	1971845-2
natural	4		1	4	4	1971845-2
natural	4		1	4	4	1971845-2
natural	4		1	4	4	1971845-2
natural	4		1	4	4	1971845-2
natural	4		1	4	4	1971845-2
natural	4		1	4	4	1971845-2
natural	4		1	4	4	1971845-2
natural	4		1	4	4	1971845-2
natural	4		1	4	4	1971845-2
natural	4		1	4	4	1971845-2

THIS DRAWING IS A CONTROLLED DOCUMENT.

OWN: HRP 21Jan2013
CHK: HAPYE 21Jan2013
APVD: YJEM 21Jan2013

TE Connectivity

NAME: RAST 5 TAB HEADER ASSY
DIN STYLE, TH, VERTICAL

PRODUCT SPEC: 108-106080
APPLICATION SPEC:

SIZE: A1 CAGE CODE: 00779 DRAWING NO: 1971845
WEIGHT: -

Customer Drawing SCALE: 8:1 SHEET 2 OF 6 REV B

LOC		DIST		REVISIONS			
P	LTN	DESCRIPTION	DATE	OWN	APVD		
-	-	SEE SHEET 1	-	-	-	-	-

color	QTY	②	QTY	①	NO. OF POS.	TE PART NO.
NATURAL	8	1	1	8	8	6-1971846-8
						5-1971846-8
						4-1971846-8
						3-1971846-8
NATURAL	7	1	1	7	7	2-1971846-8
						1-1971846-8
						1971846-8
						1971896-7
						9-1971846-7
						8-1971846-7
						7-1971846-7
						6-1971846-7
						5-1971846-7
						4-1971846-7
NATURAL	6	1	1	6	6	3-1971846-7
						2-1971846-7
						1-1971846-7
						1971846-7
						1-1971896-6
						1971896-6
						9-1971846-6
						8-1971846-6
						7-1971846-6
						6-1971846-6
NATURAL	5	1	1	5	5	5-1971846-6
						4-1971846-6
						3-1971846-6
						2-1971846-6
						1-1971846-6
						1971846-6
						1971896-5
						9-1971846-5
						8-1971846-5
						7-1971846-5

color	QTY	②	QTY	①	NO. OF POS.	TE PART NO.
NATURAL	4	1	1	4	4	1-2298031-4
						9-1971896-4
						7-1971896-4
						6-1971896-4
NATURAL	3	1	1	3	3	5-1971896-4
						4-1971896-4
						3-1971896-4
						2-1971896-4
						1-1971896-4
						1971896-4
						9-1971846-4
						8-1971846-4
						7-1971846-4
						6-1971846-4
NATURAL	2	1	1	2	2	6-1971846-4
						5-1971846-4
						4-1971846-4
						3-1971846-4
						2-1971846-4
						1-1971846-4
						1971846-4
						4-1971896-3
						3-1971896-3
						2-1971896-3
NATURAL	1	1	1	1	1	1-1971896-3
						1971896-3
						9-1971846-3
						8-1971846-3
						7-1971846-3
						6-1971846-3
						5-1971846-3
						4-1971846-3
						3-1971846-3
						2-1971846-3
NATURAL	1	1	1	1	1	1-1971846-3
						1971846-3
						6-1971896-2
						5-1971896-2
						4-1971896-2
						3-1971896-2
						2-1971896-2
						1-1971896-2
						1971896-2
						9-1971846-2
8-1971846-2						
NATURAL	1	1	1	1	1	7-1971846-2
						6-1971846-2
						5-1971846-2
						4-1971846-2
						3-2304599-2
						3-1971846-2
						2-1971846-2
						1-1971846-2
						1971846-2
						1971846-2

THIS DRAWING IS A CONTROLLED DOCUMENT.		OWN: JRP 21Jan2013	 TE Connectivity NAME: RAST 5 TAB HEADER ASSY DIN STYLE, TH, VERTICAL
DIMENSIONS: mm		CHK: HAPYE 21Jan2013	
TOLERANCES UNLESS OTHERWISE SPECIFIED:		APVD: YHM 21Jan2013	
0 PLC ± 1 PLC ± 2 PLC ±0.25 3 PLC ± 4 PLC ± ANGLES ±		PRODUCT SPEC: 108-106080 APPLICATION SPEC: WEIGHT: Customer Drawing	
MATERIAL:	FINISH:	SIZE: A1	CAGE CODE: 00779 DRAWING NO: 1971845 SCALE: 8:1 SHEET 3 OF 6 REV B

LOC		DIST		REVISIONS			
P	LTN	DESCRIPTION	DATE	OWN	APVD		
-	-	SEE SHEET 1	-	-	-		

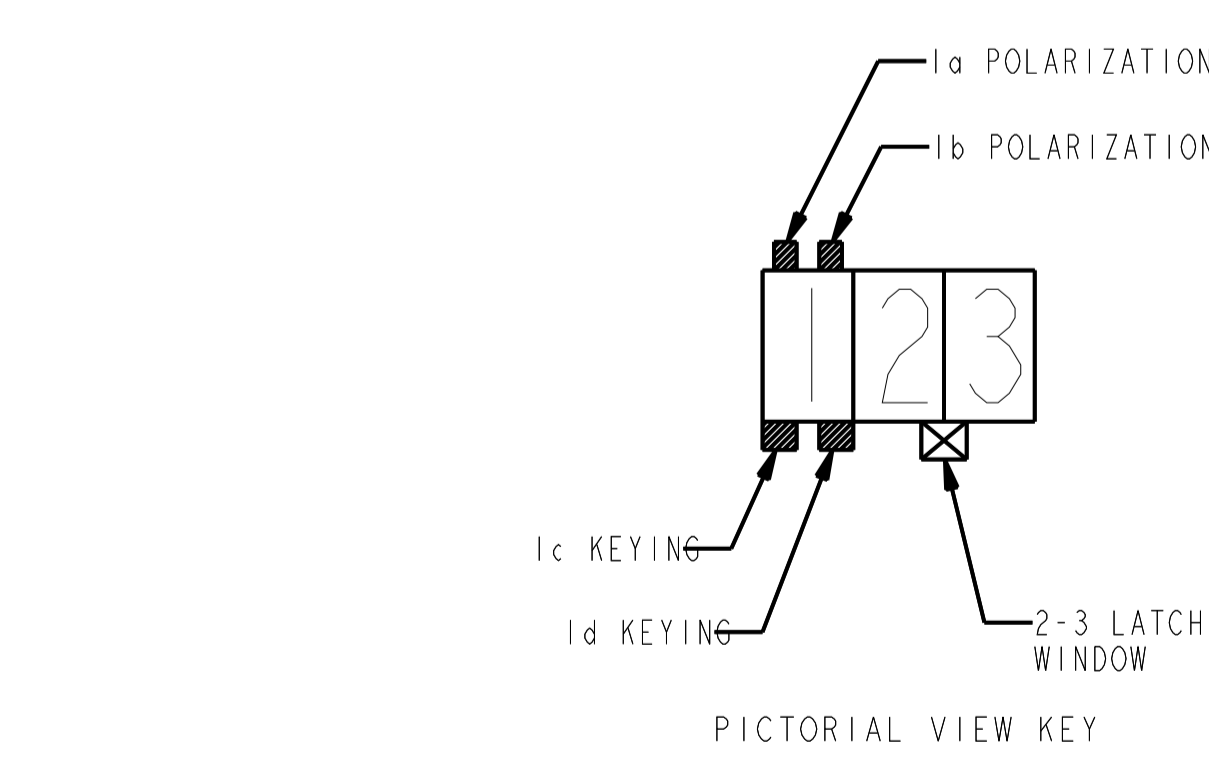
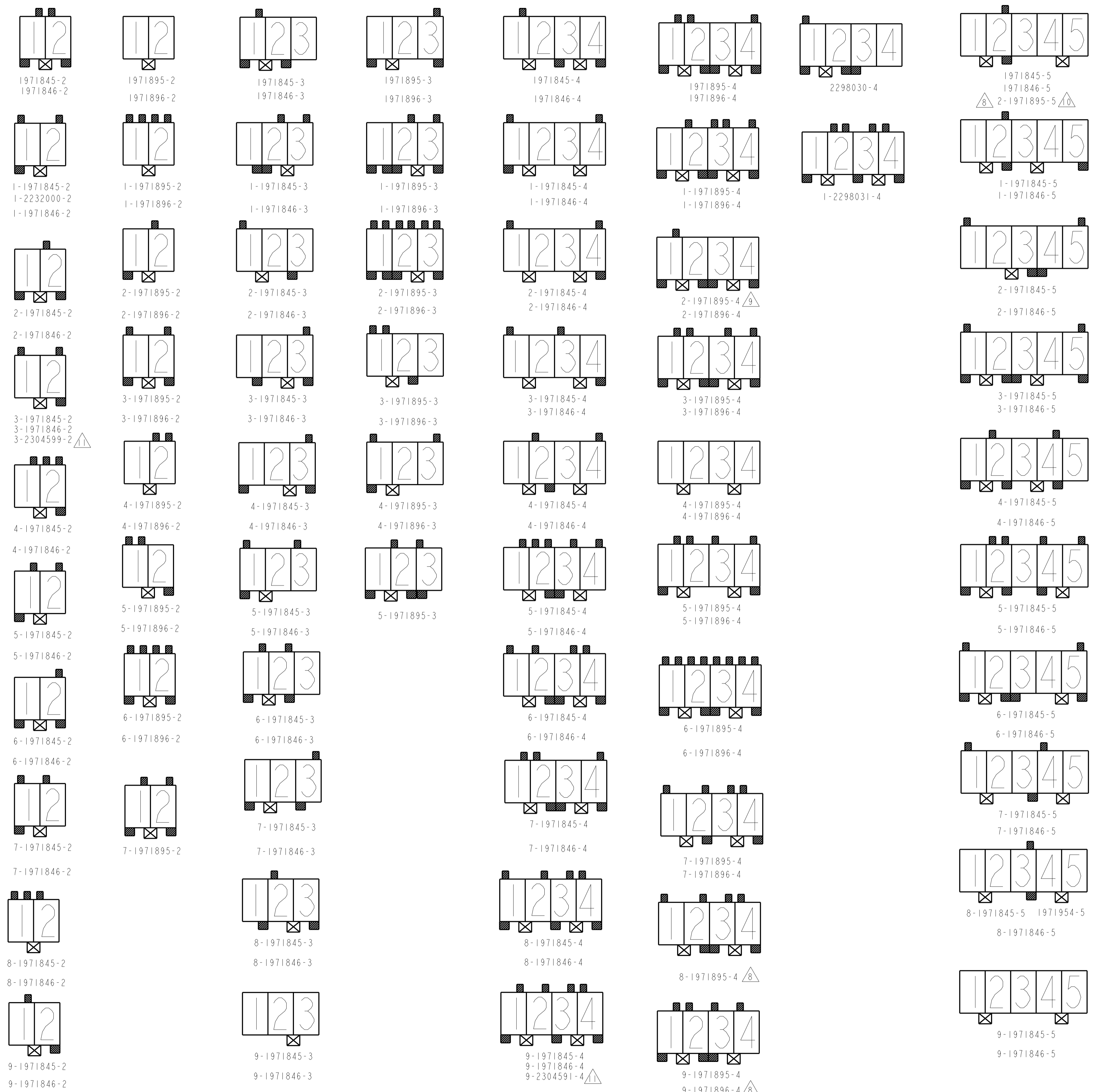

THIS DRAWING IS A CONTROLLED DOCUMENT.		OWN: HRP 21Jan2013	TE Connectivity
DIMENSIONS: mm		CHK: HAPYE 21Jan2013	
TOLERANCES UNLESS OTHERWISE SPECIFIED:		APVD: YHM 21Jan2013	NAME: RAST 5 TAB HEADER ASSY DIN STYLE, TH, VERTICAL
0 PLC ± 1 PLC ±0.25 2 PLC ± 3 PLC ± 4 PLC ± ANGLES ±		PRODUCT SPEC: 108-106080	SIZE: A1
MATERIAL: -		APPLICATION SPEC: -	CAGE CODE: 00779
FINISH: -		WEIGHT: -	DRAWING NO: 1971845
-		Customer Drawing	SCALE: 8:1
-			SHEET: 4 OF 6
-			REV: B

LOC		DIST		REVISIONS			
P	LTN	DESCRIPTION	DATE	DWN	APVD		
-	-	SEE SHEET 1	-	-	-		

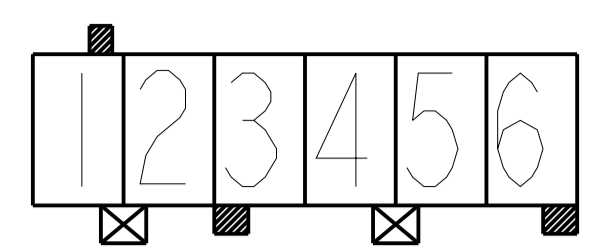

1971845-6
1971846-6

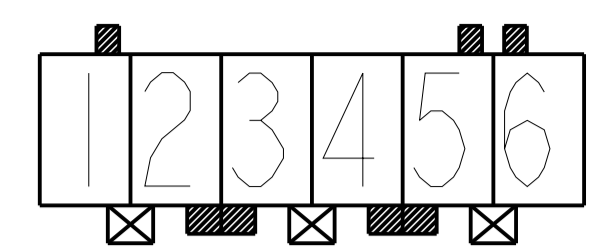

1971895-6
1971896-6

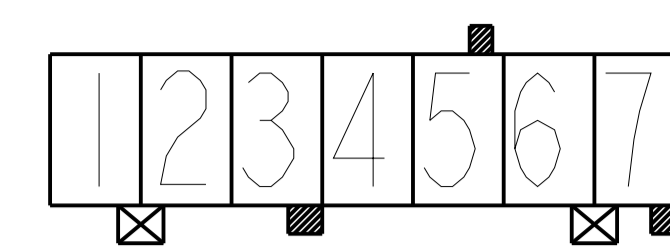

1971845-7
1971846-7

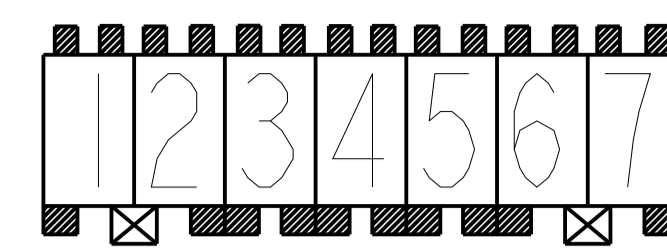

1971895-7
1971896-7

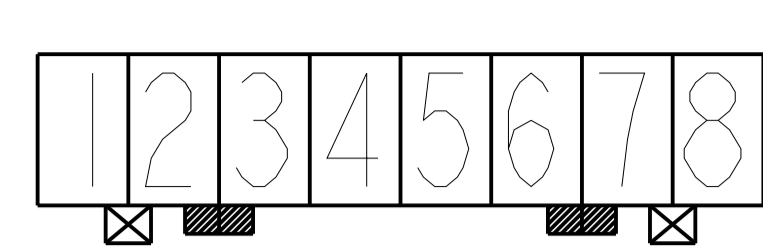

1971845-8
1971846-8

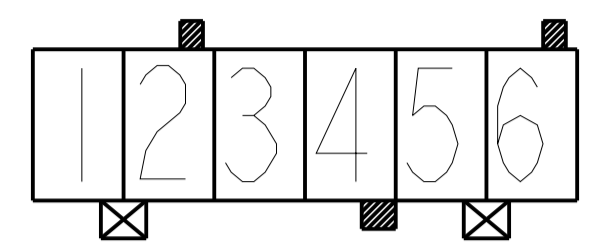

1-1971845-6
1-1971846-6

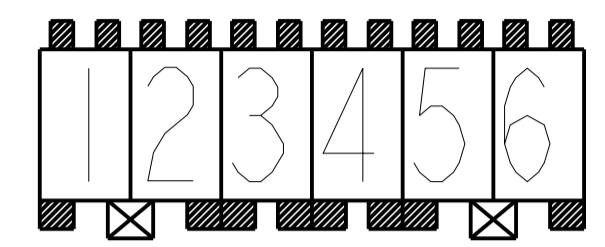

1-1971895-6
1-1971896-6

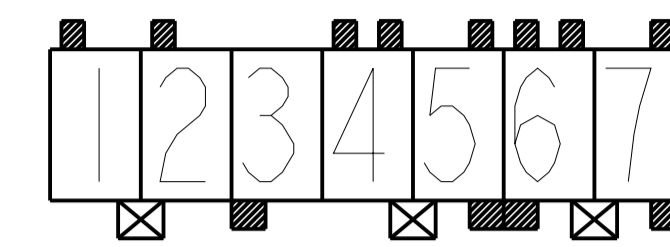

1-1971845-7
1-1971846-7

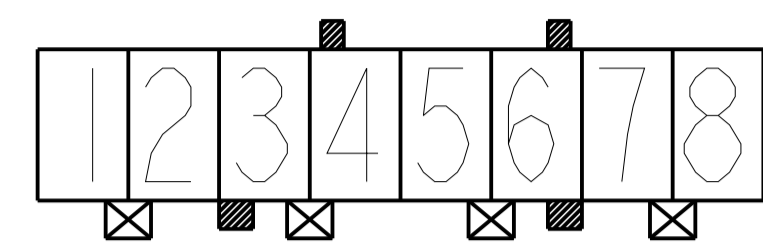

1-1971845-8
1-1971846-8

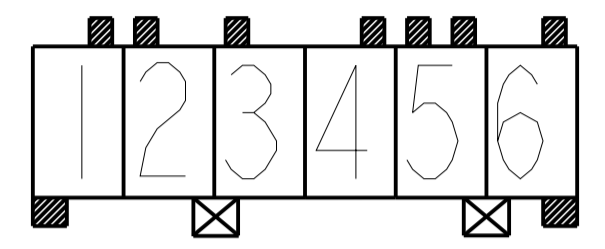

2-1971845-6
2-1971846-6

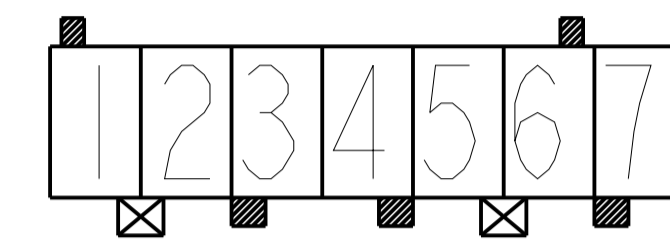

2-1971845-7
2-1971846-7

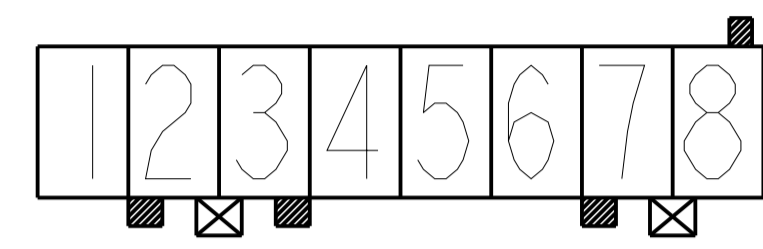

2-1971845-8
2-1971846-8

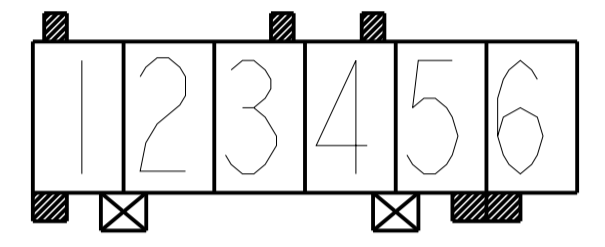

3-1971845-6
3-1971846-6

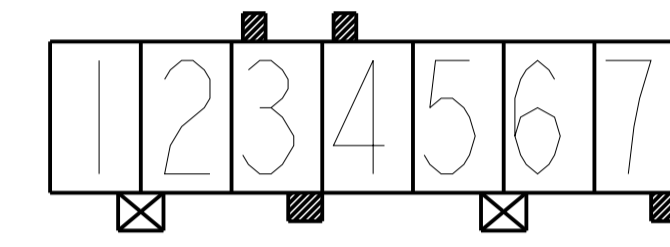

3-1971845-7
3-1971846-7

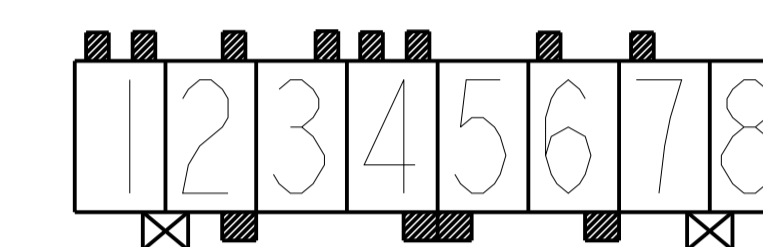

3-1971845-8
3-1971846-8

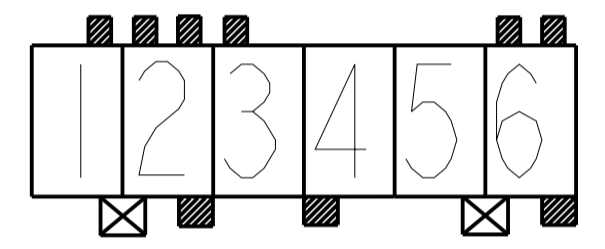

4-1971845-6
4-1971846-6

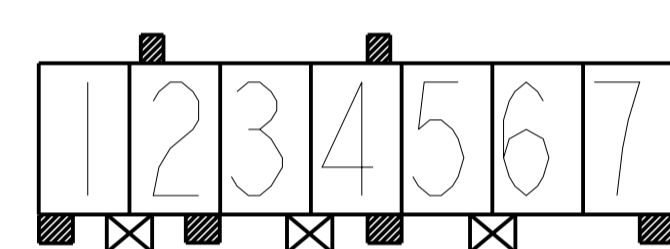

4-1971845-7
4-1971846-7

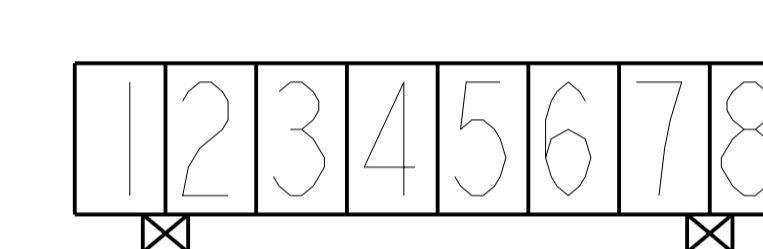

4-1971845-8
4-1971846-8

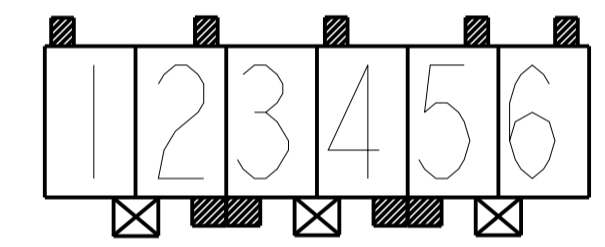

5-1971845-6
5-1971846-6

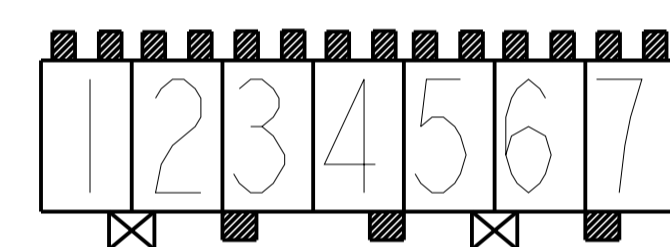

5-1971845-7
5-1971846-7

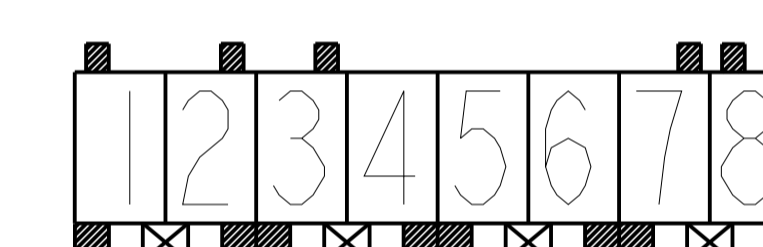

5-1971845-8
5-1971846-8

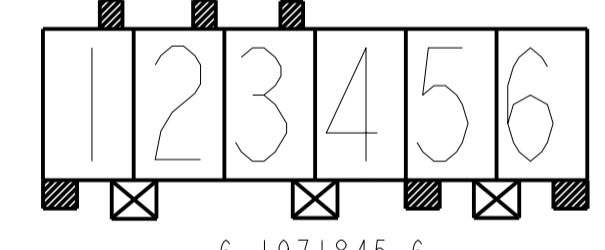

6-1971845-6
6-1971846-6

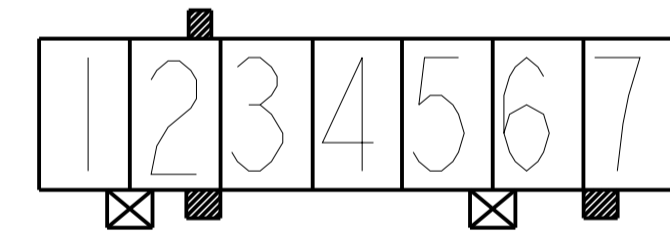

6-1971845-7 1971946-7
6-1971846-7

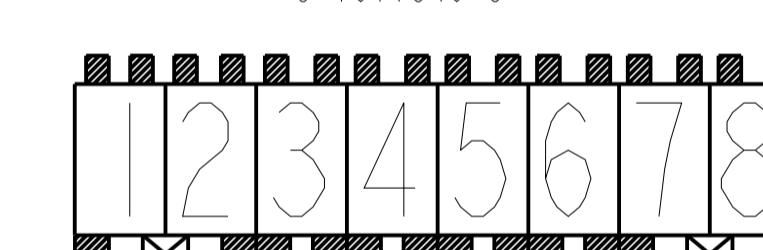

6-1971845-8
6-1971846-8

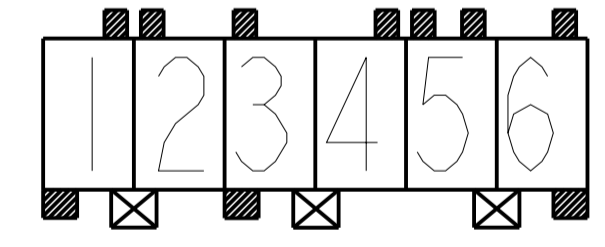

7-1971845-6
7-1971846-6

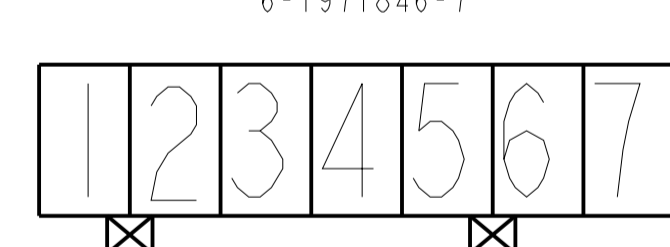

7-1971845-7
7-1971846-7

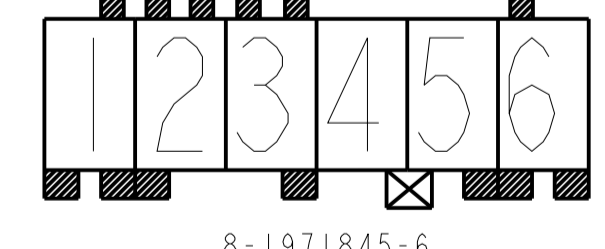

8-1971845-6
8-1971846-6

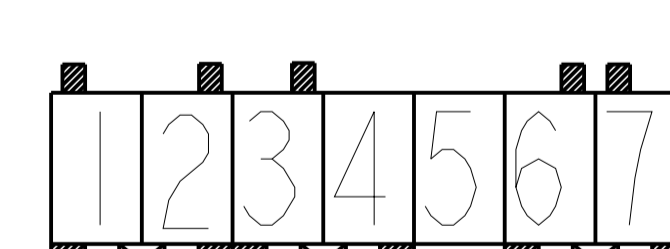

8-1971845-7
8-1971846-7

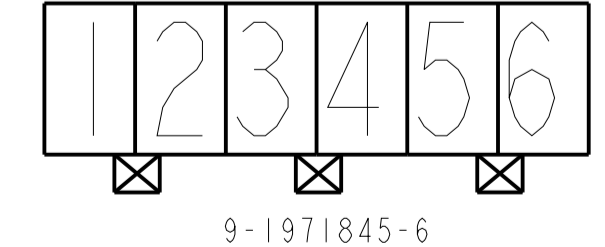

9-1971845-6
9-1971846-6

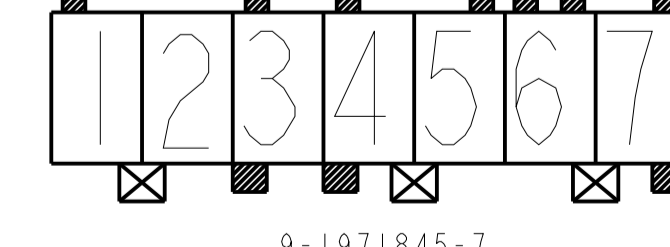

9-1971845-7
9-1971846-7

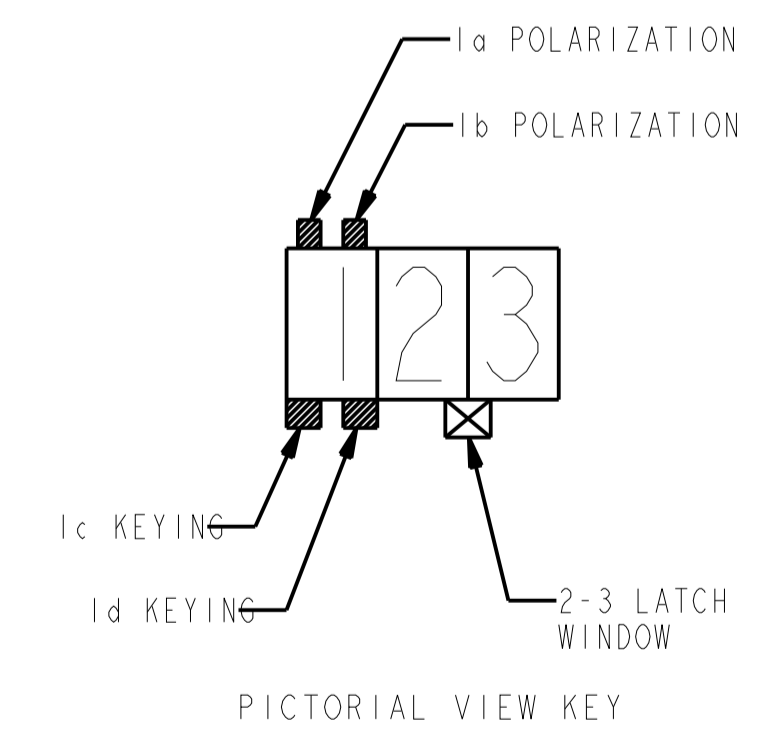

THIS DRAWING IS A CONTROLLED DOCUMENT.		DWN: HRP 21Jan2013	 TE Connectivity
DIMENSIONS: mm		CHK: HAPYE 21Jan2013	
TOLERANCES UNLESS OTHERWISE SPECIFIED:		APVD: YHM 21Jan2013	NAME: RAST 5 TAB HEADER ASSY DIN STYLE, TH, VERTICAL
0 PLC ±	1 PLC ±0.25	PRODUCT SPEC	SIZE: A1
2 PLC ±	3 PLC ±	APPLICATION SPEC	CAGE CODE: 00779
4 PLC ±	ANGLES ±	WEIGHT	DRAWING NO: 1971845
FINISH		Customer Drawing	SCALE: 8:1
		SHEET 5 OF 6	
		REV B	

LOC		DIST		REVISIONS			
P	LTN	DESCRIPTION	DATE	DWN	APVD		
-	-	SEE SHEET 1	-	-	-		

FOR ANY KEYING CONFIGURATION, THERE ARE EIGHT COLORS AVAILABLE, BESIDES THE NATURAL COLOR. THERE ARE OTHER SEVEN COLORS, INCLUDE: YELLOW, BLUE, GREY, PURPLE, RED, GREEN, BLACK. THE WHITE VERSION IS PRELIMINARY. THE P/N OF THE COLOR CONNECTOR ARE BASED ON THE NATURAL CONNECTOR. THE PREFIX AND POSTFIX ARE THE SAME FOR THE SAME KEYING CONFIGURATION, BUT THE BASE NUMBERS ARE DIFFERENT ACCORDING TO DIFFERENT COLOR. THE FOLLOWING SHOWS WHAT'S THE P/N FOR COLOR CONNECTOR

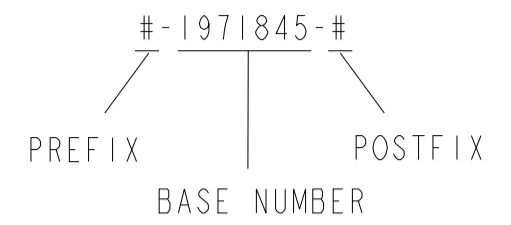

COLOR	PART NUMBER OF THE CONNECTOR				COMMENTS
	WITH MATT TIN PLATING CONTACT (SPECIAL P/N: 2-1971895-4, 2-1971845-6, 6-1971845-5, 5-1971845-8 AND 2-1971895-5 ARE WITH BRIGHT TIN)		WITH AG PLATING CONTACT		
NATURAL	#-1971845-#	#-1971895-#	#-1971846-#	#-1971896-#	THE DETAIL P/N FOR DIFFERENT KEYING SEE SHEET 2-5
RED	#-1971946-#	#-1971948-#	#-1971947-#	#-1971949-#	THE PREFIX AND POSTFIX ARE THE SAME WITH THE P/N OF THE NATURAL CONNECTOR FOR THE SAME KEYING, POLARIZATION, LATCH WINDOW CONFIGURATION. JUST THE BASE NUMBERS ARE DIFFERENT BASED ON DIFFERENT COLOR. # CAN BE THE NUMBER FROM 0 TO 9. BUT THERE ARE TWO EXEMPTION PART NUMBERS. 1971954-5 (BLUE) AND 1971946-7 (RED)
BLUE	#-1971954-#	#-1971956-#	#-1971955-#	#-1971957-#	
YELLOW	#-2232008-#	#-2232010-#	#-2232009-#	#-2232011-#	
BALCK	#-2232000-#	#-2232002-#	#-2232001-#	#-2232003-#	
GREY	#-2232016-#	#-2232018-#	#-2232017-#	#-2232019-#	
GREEN	#-1971962-#	#-1971964-#	#-1971963-#	#-1971965-#	
PURPLE	#-2232024-#	#-2232026-#	#-2232025-#	#-2232027-#	
WHITE	#-2232289-#	#-2232291-#	#-2232290-#	#-2232292-#	

THERE ARE TWO EXEMPTION FOR COLOR PART NUMBERS

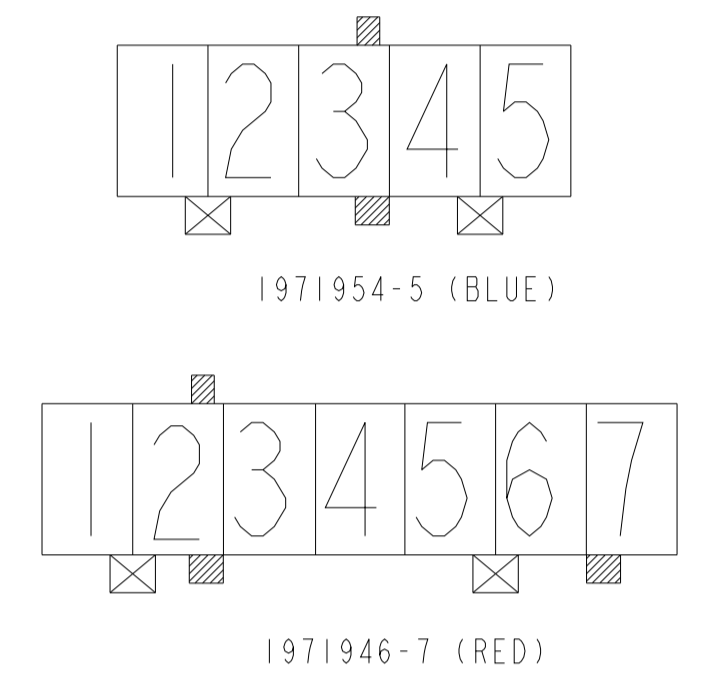

FOR EXAMPLE, IF A CONNECTOR WITH THE CONFIGURATION AS BELOW, AND WITH MATT TIN PLATING CONTACT, IN THE SHEET 4, WE CAN FIND THE RELATED CONNECTOR P/N WITH NATURAL COLOR IS 1-1971845-4, THEN WE CAN LOOK IN THE ABOVE TABLE TO FIND THE CONNECTOR P/N WITH RED COLOR IS 1-1971946-3

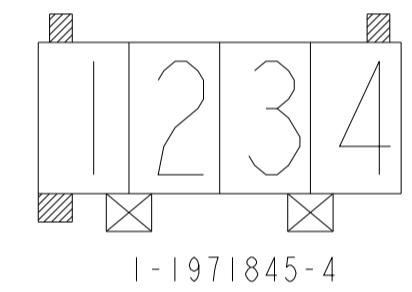

COLOR	PART NUMBER OF THE CONNECTOR		COMMENTS
	WITH BRIGHT TIN PLATING CONTACT		
NATURAL	#-2232906-#	#-2232907-#	THE KEYING, POLARIZATION AND LATCH WINDOW CONFIGURATION ARE SAME AS THE MATT TIN CONNECTOR WITH THE SAME PREFIX AND POSTFIX FOR EACH COLOR. FOR EXAMPLE: 2232906-4 AND 1971845-4 HAVE SAME KEYING, POLARIZATION AND LATCH WINDOW CONFIGURATION. 2232907-4 AND 1971895-4 HAVE SAME KEYING, POLARIZATION AND LATCH WINDOW CONFIGURATION. THE DETAIL KEYING, POLARIZATION AND LATCH WINDOW CONFIGURATION FOR EACH P/N, PLEASE SEE SHEET 2-5
RED	#-2232908-#	#-2232909-#	
BLUE	#-2232910-#	#-2232911-#	
YELLOW	#-2232912-#	#-2232913-#	
BALCK	#-2232914-#	#-2232915-#	
GREY	#-2232916-#	#-2232917-#	
GREEN	#-2232918-#	#-2232919-#	
PURPLE	#-2232920-#	#-2232921-#	
WHITE	#-2232922-#	#-2232923-#	

THIS DRAWING IS A CONTROLLED DOCUMENT.		DWN: HRP 21Jan2013	TE Connectivity
DIMENSIONS: mm		CHK: HAPYE 21Jan2013	
		APVD: YIM 21Jan2013	NAME: RAST 5 TAB HEADER ASSY DIN STYLE, TH, VERTICAL
TOLERANCES UNLESS OTHERWISE SPECIFIED:		PRODUCT SPEC: 108-106080	SIZE: A1
0 PLC ±		APPLICATION SPEC: -	CAGE CODE: 00779
1 PLC ±0.25		WEIGHT: -	DRAWING NO: 1971845
2 PLC ±		RESTRICTED TO: -	SCALE: 8:1
3 PLC ±		Customer Drawing	SHEET 6 OF 6
4 PLC ±			REV B
ANGLES ±2°			

Mouser Electronics

Authorized Distributor

Click to View Pricing, Inventory, Delivery & Lifecycle Information:

[TE Connectivity:](#)

[4-1971895-3](#)