

| LOC | DIST | REVISIONS | | | | | |
|-----|------|-----------|-----|---------------|-----------|-----|------|
| | | P. | LTN | DESCRIPTION | DATE | DWN | APVD |
| ES | 00 | A23 | | ECR-17-013299 | 11SEP2017 | WW | RR |
| | | A24 | | ECR-18-008274 | 30MAY2018 | KD | FL |
| | | A25 | | ECR-19-012819 | 16AUG2019 | SM | FL |
| | | B | | ECR-21-100878 | 24MAR2021 | KD | FL |

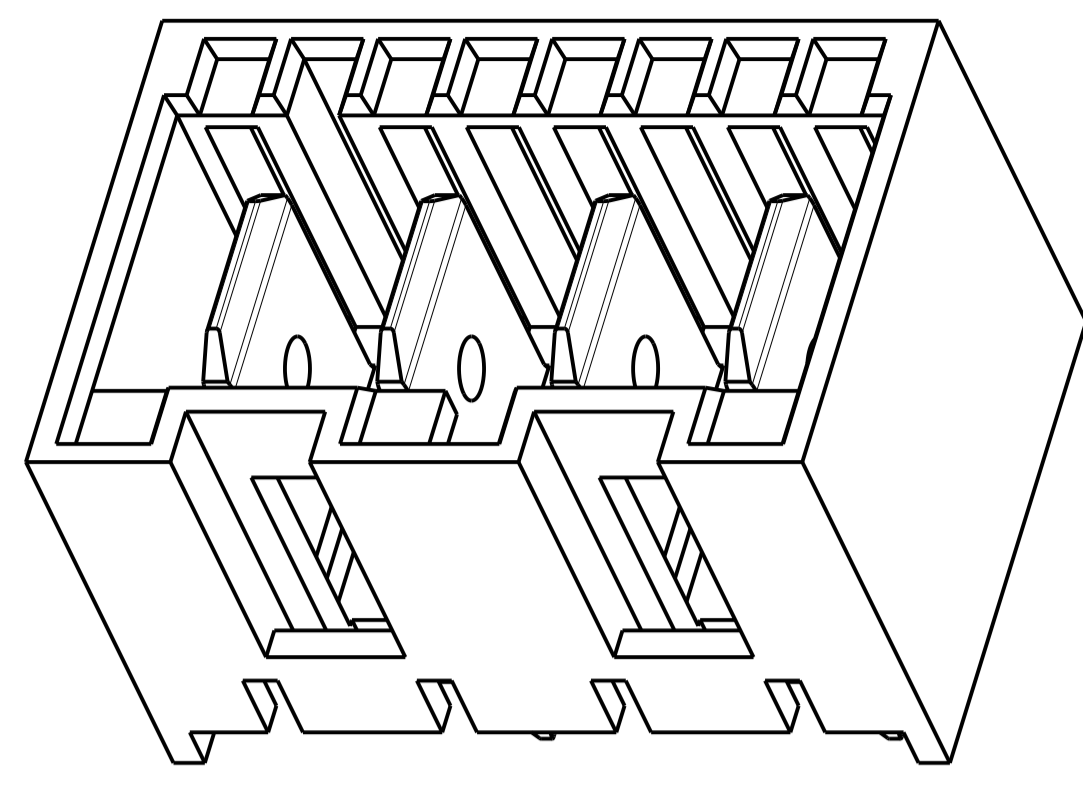

- NOTE**
- HOUSING HAS RAST 5 COMPLIANT KEYING, LATCHING, AND POLARIZATION. TAB IS 6.30 X 0.8 ACCORDING TO DIN 46244
 - SEE SHEET 2 FOR AVAILABLE CONFIGURATIONS
 - MATERIAL: HOUSING, NYLON, UL94 V0, 750°C GWT NO FLAME CONTACT, COPPER ALLOY, 0.8MM THICK
 - FINISH: CONTACTS, MATT TIN PLATING OVERALL, NICKEL UNDER-PLATING BRIGHT TIN PLATING OVERALL, NICKEL UNDER-PLATING SILVER PLATING OVERALL, NICKEL UNDER-PLATING
- ⚠ PCB TABS INSERTED IN A STAGGERED PATTERN BEGINNING WITH POSITION 1 (Cct1)
- ⚠ THE PART NUMBERS SHOWING IN SHEET 2 & 3 & 4 & 5 ARE FOR NATURAL COLOR. THE PART NUMBER FOR OTHER COLOR ARE BASED ON THE NATURAL ONE: FOR THE SAME CONFIGURATION, THE PREFIX AND POSTFIX OF THE P/N ARE THE SAME, ONLY THE BASE NUMBER IS DIFFERENT ACCORDING TO DIFFERENT COLOR, DETAIL PLEASE SEE SHEET 6
- 7 PACKAGING: LOOSE PIECE OR TUBE. THE PART NUMBERS IN THIS DRAWING ARE WITH LOOSE PIECE PACKAGING. PLEASE CONTACT TE SALES REPRESENTATIVES FOR TUBE PACKAGING REQUIREMENT.
- ⚠ PRELIMINARY PART, NOT RELEASED FOR PRODUCTION.
- 9 FOR P/N: 2-1971895-4:
 1) THE CONTACTS ARE WITH BRIGHT TIN PLATING
 2) INSERTION FORCE MATING WITH 4P MONO SHAPE MKI CONNECTOR: 85N MAX ACCORDING TO IEC 60512-13-1, Test 13a.
- ⚠ FOR P/N: 5-1971845-8, 2-1971845-6, 6-1971845-5 AND 2-1971895-5:
 1) THE CONTACTS ARE WITH BRIGHT TIN PLATING.
- ⚠ PART NUMBERS WITH TUBE PACKAGING

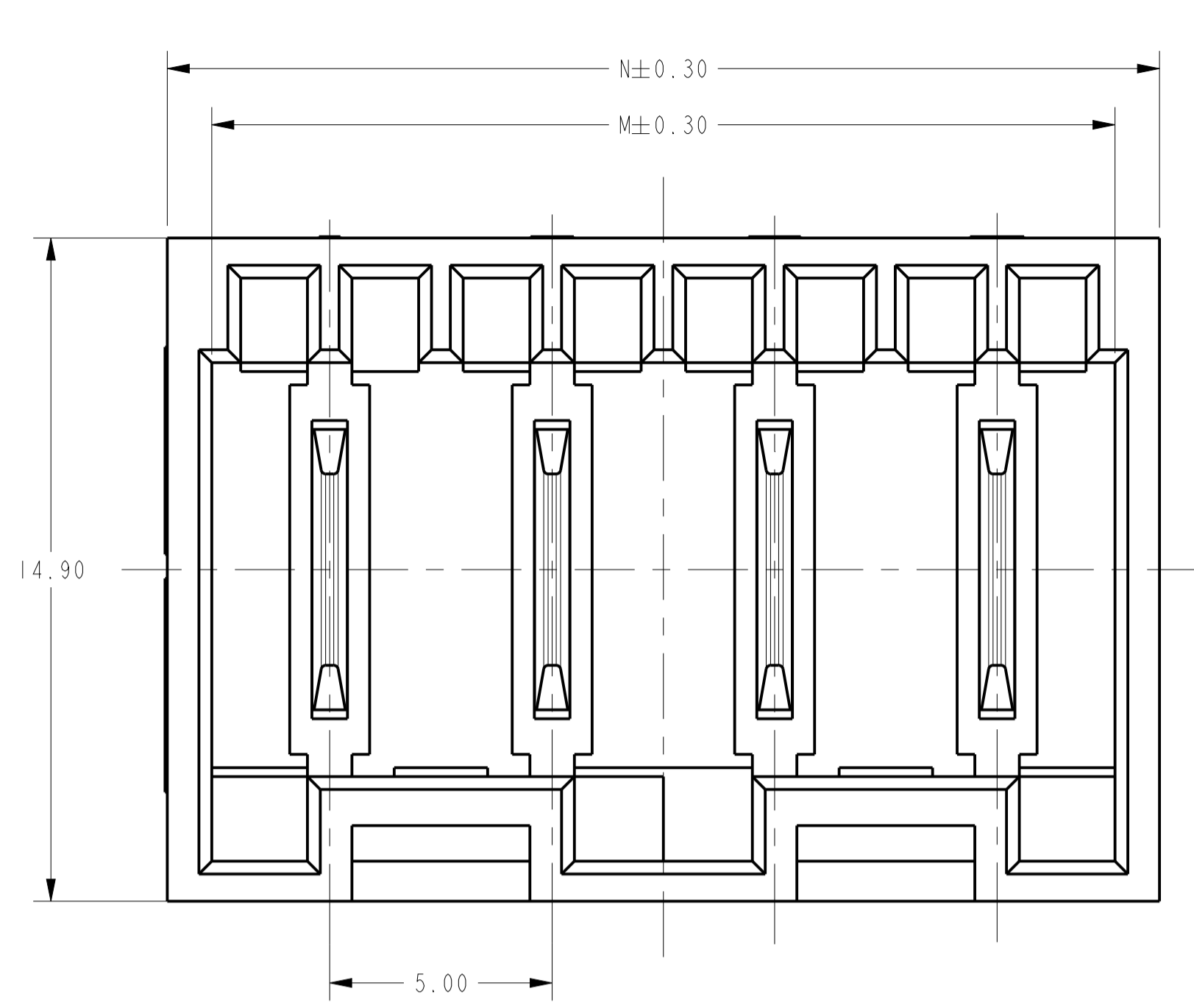
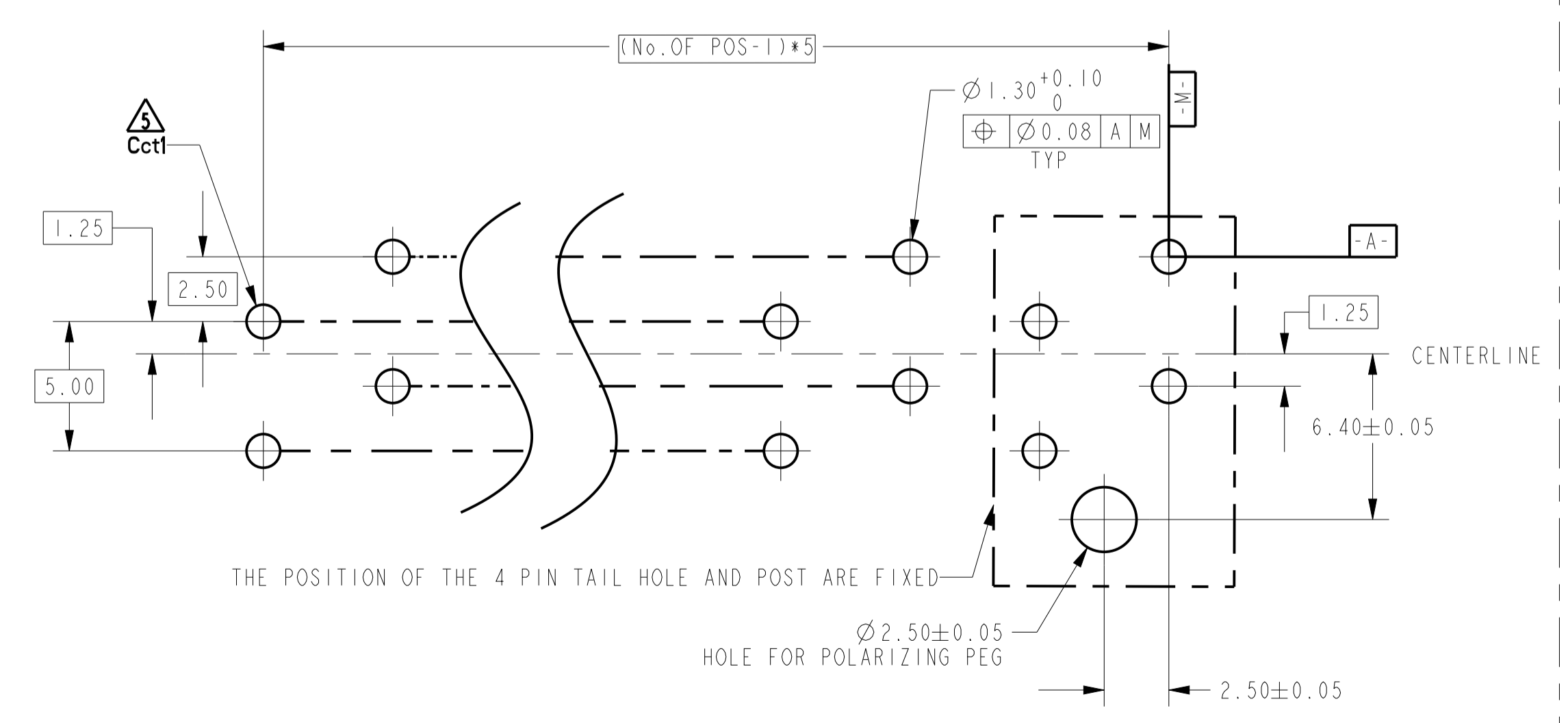
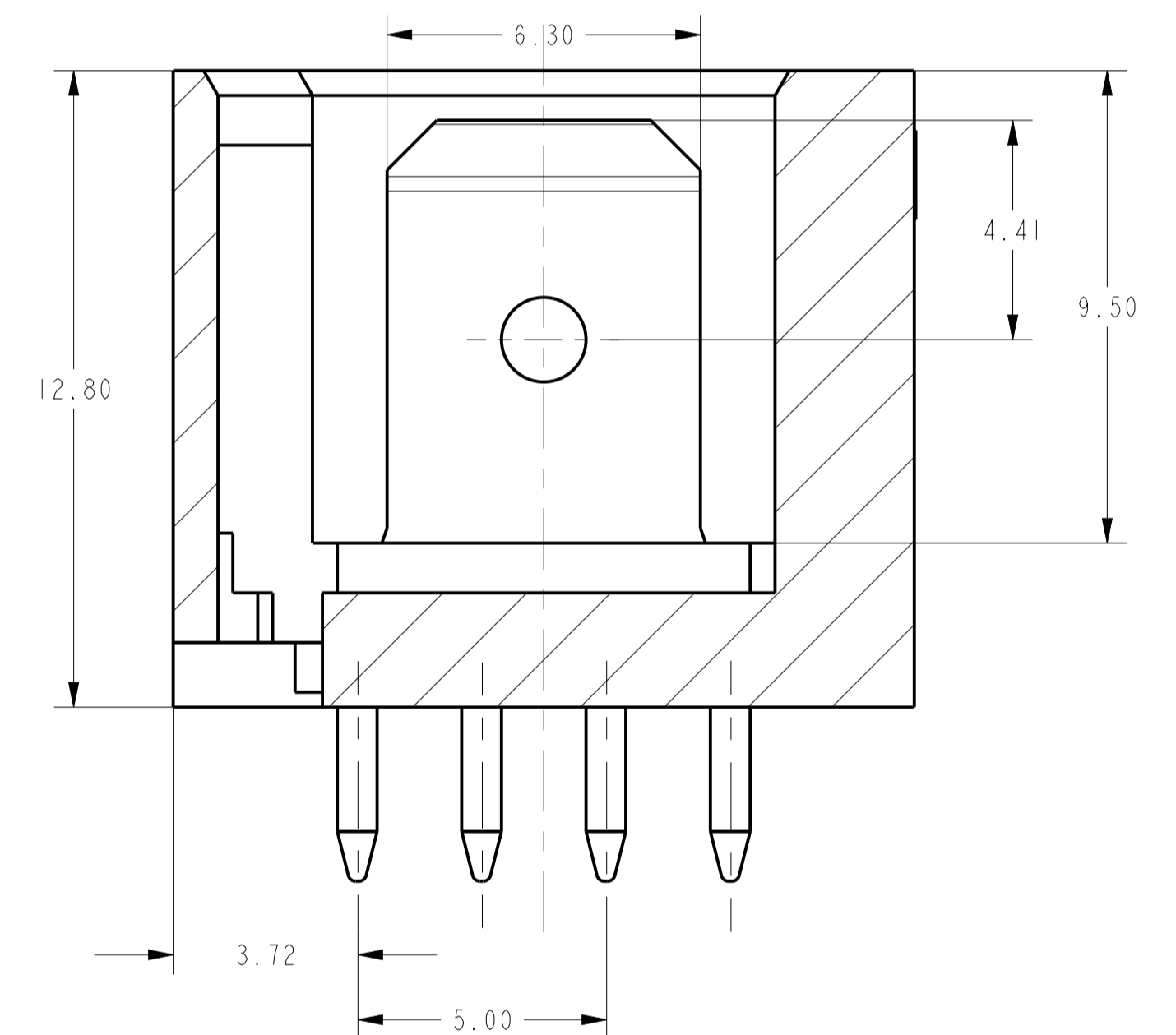
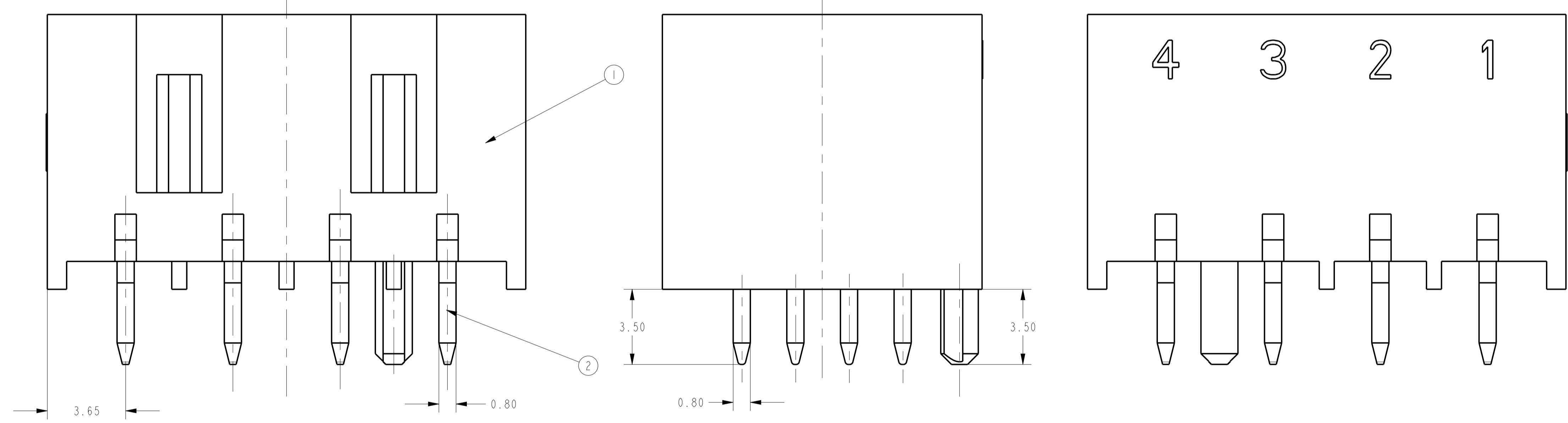

RECOMMEND PCB LAYOUT - SOLDER SIDE
 EVEN NUMBER OF PINS
 PCB 15±0.2 THICK

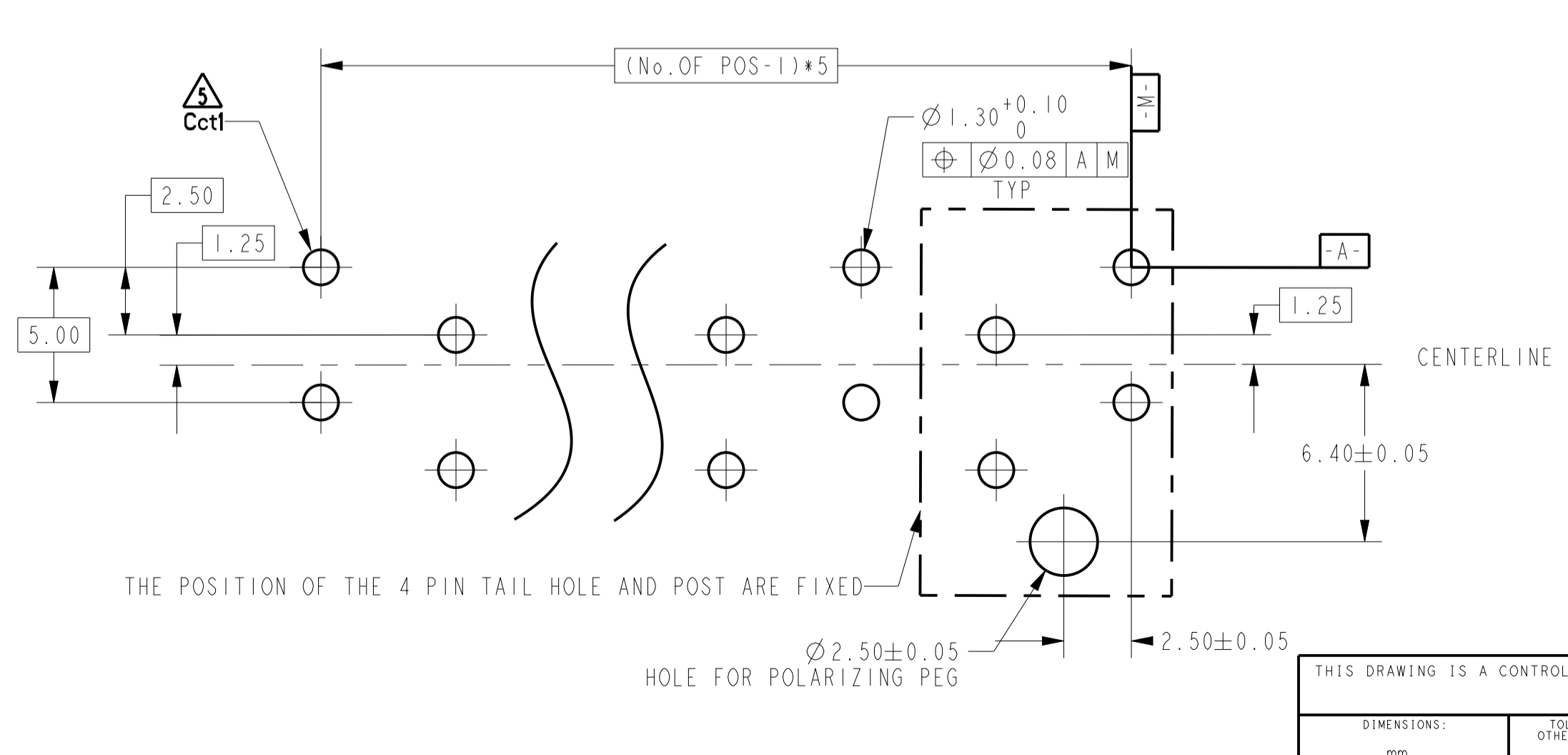

RECOMMEND PCB LAYOUT - SOLDER SIDE
 ODD NUMBER OF PINS
 PCB 15±0.2 THICK

| | | |
|-------|-------|-------------|
| 42.30 | 40.30 | 8 |
| 37.30 | 35.30 | 7 |
| 32.30 | 30.30 | 6 |
| 27.30 | 25.30 | 5 |
| 22.30 | 20.30 | 4 |
| 17.30 | 15.30 | 3 |
| 12.30 | 10.30 | 2 |
| N | M | NO. OF POS. |

THIS DRAWING IS A CONTROLLED DOCUMENT.

| | | | |
|-------------|--|----------------------|------------------------------|
| DIMENSIONS: | TOLERANCES UNLESS OTHERWISE SPECIFIED: | DWN: HRP 21Jan2013 | NAME: RAST 5 TAB HEADER ASSY |
| mm | 0 PLC ± | CHK: HAPYE 21Jan2013 | DIN STYLE, TH, VERTICAL |
| | 1 PLC ± | APVD: YHM 21Jan2013 | 108-106080 |
| | 2 PLC ±0.25 | PRODUCT SPEC | |
| | 3 PLC ± | APPLICATION SPEC | |
| | 4 PLC ± | WEIGHT | |
| | 5 PLC ± | Customer Drawing | |
| | ANGLES ± | SCALE: 8:1 | SHEET 1 OF 6 |
| MATERIAL: | FINISH: | SIZE: A1 | REV: B |

Customer Drawing

| LOC | DIST | REV | DATE | BY | APPV |
|-----|------|-----|------|----|------|
| | | | | | |

| color | QTY | ② | QTY | ① | NO. OF POS. | TE PART NO. | | |
|---------|-----|--|-----|---|-------------|---|---|---|
| NATURAL | 8 | TAB CONTACT MATT TIN PLATING (5-1971845-8, 6-1971845-5, 2-1971845-6 AND 2-1971895-5 WITH BRIGHT TIN) | 1 | 8 | 8 | 6-1971845-8 5-1971845-8 Δ 4-1971845-8 3-1971845-8 2-1971845-8 1-1971845-8 1971845-8 | | |
| RED | 7 | | 1 | 7 | 7 | 1971946-7 1971895-7 9-1971845-7 8-1971845-7 7-1971845-7 6-1971845-7 5-1971845-7 4-1971845-7 3-1971845-7 2-1971845-7 1-1971845-7 1971845-7 | | |
| NATURAL | | | 1 | 6 | 6 | 1-1971895-6 1971895-6 9-1971845-6 8-1971845-6 7-1971845-6 6-1971845-6 5-1971845-6 4-1971845-6 3-1971845-6 2-1971845-6 Δ 1-1971845-6 1971845-6 | | |
| BLUE | | | 5 | 1 | 5 | 5 | 1971954-5 Δ 2-1971895-5 Δ 1-1971895-5 1971895-5 9-1971845-5 8-1971845-5 7-1971845-5 6-1971845-5 Δ 5-1971845-5 4-1971845-5 3-1971845-5 2-1971845-5 1-1971845-5 1971845-5 | |
| NATURAL | | | | 1 | 4 | 4 | 6-1971845-8 5-1971845-8 Δ 4-1971845-8 3-1971845-8 2-1971845-8 1-1971845-8 1971845-8 | |
| NATURAL | | | | 1 | 3 | 3 | 3 | 1971946-7 1971895-7 9-1971845-7 8-1971845-7 7-1971845-7 6-1971845-7 5-1971845-7 4-1971845-7 3-1971845-7 2-1971845-7 1-1971845-7 1971845-7 |
| NATURAL | | | | 1 | 2 | 2 | 2 | 1-1971895-6 1971895-6 9-1971845-6 8-1971845-6 7-1971845-6 6-1971845-6 5-1971845-6 4-1971845-6 3-1971845-6 2-1971845-6 Δ 1-1971845-6 1971845-6 |
| NATURAL | | | | 1 | 1 | 1 | 1 | 1971954-5 Δ 2-1971895-5 Δ 1-1971895-5 1971895-5 9-1971845-5 8-1971845-5 7-1971845-5 6-1971845-5 Δ 5-1971845-5 4-1971845-5 3-1971845-5 2-1971845-5 1-1971845-5 1971845-5 |
| NATURAL | | | | 1 | 1 | 1 | 1 | 1971954-5 Δ 2-1971895-5 Δ 1-1971895-5 1971895-5 9-1971845-5 8-1971845-5 7-1971845-5 6-1971845-5 Δ 5-1971845-5 4-1971845-5 3-1971845-5 2-1971845-5 1-1971845-5 1971845-5 |
| NATURAL | | | | 1 | 1 | 1 | 1 | 1971954-5 Δ 2-1971895-5 Δ 1-1971895-5 1971895-5 9-1971845-5 8-1971845-5 7-1971845-5 6-1971845-5 Δ 5-1971845-5 4-1971845-5 3-1971845-5 2-1971845-5 1-1971845-5 1971845-5 |
| NATURAL | | 1 | | 1 | 1 | 1 | 1971954-5 Δ 2-1971895-5 Δ 1-1971895-5 1971895-5 9-1971845-5 8-1971845-5 7-1971845-5 6-1971845-5 Δ 5-1971845-5 4-1971845-5 3-1971845-5 2-1971845-5 1-1971845-5 1971845-5 | |
| NATURAL | 1 | 1 | | 1 | 1 | 1971954-5 Δ 2-1971895-5 Δ 1-1971895-5 1971895-5 9-1971845-5 8-1971845-5 7-1971845-5 6-1971845-5 Δ 5-1971845-5 4-1971845-5 3-1971845-5 2-1971845-5 1-1971845-5 1971845-5 | | |
| NATURAL | 1 | 1 | | 1 | 1 | 1971954-5 Δ 2-1971895-5 Δ 1-1971895-5 1971895-5 9-1971845-5 8-1971845-5 7-1971845-5 6-1971845-5 Δ 5-1971845-5 4-1971845-5 3-1971845-5 2-1971845-5 1-1971845-5 1971845-5 | | |

| color | QTY | ② | QTY | ① | NO. OF POS. | TE PART NO. |
|---------|-----|---|-----|---|-------------|--|
| GREEN | 4 | TAB CONTACT w/ MATT TIN PLATING (2-1971895-4 IS WITH BRIGHT TIN) | 1 | 4 | 4 | 1971962-4 2298030-4 9-1971895-4 8-1971895-4 Δ 7-1971895-4 6-1971895-4 5-1971895-4 4-1971895-4 3-1971895-4 2-1971895-4 Δ 1-1971895-4 1971895-4 Δ 9-2304591-4 9-1971845-4 8-1971845-4 7-1971845-4 6-1971845-4 5-1971845-4 4-1971845-4 3-1971845-4 2-1971845-4 1-1971845-4 1971845-4 |
| natural | 3 | | 1 | 3 | 3 | 5-1971895-3 4-1971895-3 3-1971895-3 2-1971895-3 1-1971895-3 1971895-3 9-1971845-3 8-1971845-3 7-1971845-3 6-1971845-3 5-1971845-3 4-1971845-3 3-1971845-3 2-1971845-3 1-1971845-3 1971845-3 |
| natural | 2 | | 1 | 2 | 2 | 7-1971895-2 6-1971895-2 5-1971895-2 4-1971895-2 3-1971895-2 2-1971895-2 1-1971895-2 1971895-2 9-1971845-2 8-1971845-2 7-1971845-2 6-1971845-2 5-1971845-2 4-1971845-2 3-1971845-2 2-1971845-2 1-1971845-2 1971845-2 |
| natural | 1 | | 1 | 1 | 1 | 7-1971895-2 6-1971895-2 5-1971895-2 4-1971895-2 3-1971895-2 2-1971895-2 1-1971895-2 1971895-2 9-1971845-2 8-1971845-2 7-1971845-2 6-1971845-2 5-1971845-2 4-1971845-2 3-1971845-2 2-1971845-2 1-1971845-2 1971845-2 |
| natural | 1 | | 1 | 1 | 1 | 7-1971895-2 6-1971895-2 5-1971895-2 4-1971895-2 3-1971895-2 2-1971895-2 1-1971895-2 1971895-2 9-1971845-2 8-1971845-2 7-1971845-2 6-1971845-2 5-1971845-2 4-1971845-2 3-1971845-2 2-1971845-2 1-1971845-2 1971845-2 |
| natural | 1 | | 1 | 1 | 1 | 7-1971895-2 6-1971895-2 5-1971895-2 4-1971895-2 3-1971895-2 2-1971895-2 1-1971895-2 1971895-2 9-1971845-2 8-1971845-2 7-1971845-2 6-1971845-2 5-1971845-2 4-1971845-2 3-1971845-2 2-1971845-2 1-1971845-2 1971845-2 |
| natural | 1 | | 1 | 1 | 1 | 7-1971895-2 6-1971895-2 5-1971895-2 4-1971895-2 3-1971895-2 2-1971895-2 1-1971895-2 1971895-2 9-1971845-2 8-1971845-2 7-1971845-2 6-1971845-2 5-1971845-2 4-1971845-2 3-1971845-2 2-1971845-2 1-1971845-2 1971845-2 |
| natural | 1 | | 1 | 1 | 1 | 7-1971895-2 6-1971895-2 5-1971895-2 4-1971895-2 3-1971895-2 2-1971895-2 1-1971895-2 1971895-2 9-1971845-2 8-1971845-2 7-1971845-2 6-1971845-2 5-1971845-2 4-1971845-2 3-1971845-2 2-1971845-2 1-1971845-2 1971845-2 |
| natural | 1 | | 1 | 1 | 1 | 7-1971895-2 6-1971895-2 5-1971895-2 4-1971895-2 3-1971895-2 2-1971895-2 1-1971895-2 1971895-2 9-1971845-2 8-1971845-2 7-1971845-2 6-1971845-2 5-1971845-2 4-1971845-2 3-1971845-2 2-1971845-2 1-1971845-2 1971845-2 |
| natural | 1 | | 1 | 1 | 1 | 7-1971895-2 6-1971895-2 5-1971895-2 4-1971895-2 3-1971895-2 2-1971895-2 1-1971895-2 1971895-2 9-1971845-2 8-1971845-2 7-1971845-2 6-1971845-2 5-1971845-2 4-1971845-2 3-1971845-2 2-1971845-2 1-1971845-2 1971845-2 |

THIS DRAWING IS A CONTROLLED DOCUMENT.

OWN: HRP 21Jan2013
CHK: HAPYE 21Jan2013
APPV: YHM 21Jan2013

TE Connectivity

NAME: RAST 5 TAB HEADER ASSY
DIN STYLE, TH, VERTICAL

PRODUCT SPEC: 108-106080
APPLICATION SPEC:

SIZE: A1 CAGE CODE: 00779 DRAWING NO: 1971845
WEIGHT: -

Customer Drawing SCALE: 8:1 SHEET 2 OF 6 REV B

| LOC | | DIST | | REVISIONS | | | |
|-----|-----|-------------|------|-----------|------|---|---|
| P | LTN | DESCRIPTION | DATE | OWN | APVD | | |
| - | - | SEE SHEET 1 | - | - | - | - | - |
| | | | | | | | |
| | | | | | | | |

| color | QTY | ② | QTY | ① | NO. OF POS. | TE PART NO. |
|---------|-----|---|-----|---|-------------|-------------|
| NATURAL | 8 | 1 | 1 | 8 | 8 | 6-1971846-8 |
| | | | | | | 5-1971846-8 |
| | | | | | | 4-1971846-8 |
| | | | | | | 3-1971846-8 |
| NATURAL | 7 | 1 | 1 | 7 | 7 | 2-1971846-8 |
| | | | | | | 1-1971846-8 |
| | | | | | | 1971846-8 |
| | | | | | | 1971896-7 |
| | | | | | | 9-1971846-7 |
| | | | | | | 8-1971846-7 |
| | | | | | | 7-1971846-7 |
| | | | | | | 6-1971846-7 |
| | | | | | | 5-1971846-7 |
| | | | | | | 4-1971846-7 |
| NATURAL | 6 | 1 | 1 | 6 | 6 | 3-1971846-7 |
| | | | | | | 2-1971846-7 |
| | | | | | | 1-1971846-7 |
| | | | | | | 1971846-7 |
| | | | | | | 1-1971896-6 |
| | | | | | | 1971896-6 |
| | | | | | | 9-1971846-6 |
| | | | | | | 8-1971846-6 |
| | | | | | | 7-1971846-6 |
| | | | | | | 6-1971846-6 |
| NATURAL | 5 | 1 | 1 | 5 | 5 | 5-1971846-6 |
| | | | | | | 4-1971846-6 |
| | | | | | | 3-1971846-6 |
| | | | | | | 2-1971846-6 |
| | | | | | | 1-1971846-6 |
| | | | | | | 1971846-6 |
| | | | | | | 1971896-5 |
| | | | | | | 9-1971846-5 |
| | | | | | | 8-1971846-5 |
| | | | | | | 7-1971846-5 |

| color | QTY | ② | QTY | ① | NO. OF POS. | TE PART NO. |
|-------------|-----|---|-----|---|-------------|-------------|
| NATURAL | 4 | 1 | 1 | 4 | 4 | 1-2298031-4 |
| | | | | | | 9-1971896-4 |
| | | | | | | 7-1971896-4 |
| | | | | | | 6-1971896-4 |
| NATURAL | 3 | 1 | 1 | 3 | 3 | 5-1971896-4 |
| | | | | | | 4-1971896-4 |
| | | | | | | 3-1971896-4 |
| | | | | | | 2-1971896-4 |
| | | | | | | 1-1971896-4 |
| | | | | | | 1971896-4 |
| | | | | | | 9-1971846-4 |
| | | | | | | 8-1971846-4 |
| | | | | | | 7-1971846-4 |
| | | | | | | 6-1971846-4 |
| NATURAL | 2 | 1 | 1 | 2 | 2 | 5-1971846-4 |
| | | | | | | 4-1971846-4 |
| | | | | | | 3-1971846-4 |
| | | | | | | 2-1971846-4 |
| | | | | | | 1-1971846-4 |
| | | | | | | 1971846-4 |
| | | | | | | 4-1971896-3 |
| | | | | | | 3-1971896-3 |
| | | | | | | 2-1971896-3 |
| | | | | | | 1-1971896-3 |
| NATURAL | 1 | 1 | 1 | 1 | 1 | 1971896-3 |
| | | | | | | 9-1971846-3 |
| | | | | | | 8-1971846-3 |
| | | | | | | 7-1971846-3 |
| | | | | | | 6-1971846-3 |
| | | | | | | 5-1971846-3 |
| | | | | | | 4-1971846-3 |
| | | | | | | 3-1971846-3 |
| | | | | | | 2-1971846-3 |
| | | | | | | 1-1971846-3 |
| NATURAL | 1 | 1 | 1 | 1 | 1 | 1971846-3 |
| | | | | | | 6-1971896-2 |
| | | | | | | 5-1971896-2 |
| | | | | | | 4-1971896-2 |
| | | | | | | 3-1971896-2 |
| | | | | | | 2-1971896-2 |
| | | | | | | 1-1971896-2 |
| | | | | | | 1971896-2 |
| | | | | | | 9-1971846-2 |
| | | | | | | 8-1971846-2 |
| 7-1971846-2 | | | | | | |
| NATURAL | 1 | 1 | 1 | 1 | 1 | 6-1971846-2 |
| | | | | | | 5-1971846-2 |
| | | | | | | 4-1971846-2 |
| | | | | | | 3-1971846-2 |
| | | | | | | 2-1971846-2 |
| | | | | | | 1-1971846-2 |
| | | | | | | 1971846-2 |
| | | | | | | 3-2304599-2 |
| | | | | | | 3-1971846-2 |
| | | | | | | 2-1971846-2 |
| 1-1971846-2 | | | | | | |
| 1971846-2 | | | | | | |

| | | | |
|---|---------|--|--|
| THIS DRAWING IS A CONTROLLED DOCUMENT. | | OWN: JRP 21Jan2013 |  TE Connectivity NAME: RAST 5 TAB HEADER ASSY DIN STYLE, TH, VERTICAL |
| DIMENSIONS: mm | | CHK: HAPYE 21Jan2013 | |
| TOLERANCES UNLESS OTHERWISE SPECIFIED: | | APVD: YHM 21Jan2013 | |
| 0 PLC ± 1 PLC ± 2 PLC ±0.25 3 PLC ± 4 PLC ± ANGLES ± | | PRODUCT SPEC: 108-106080 APPLICATION SPEC: WEIGHT: Customer Drawing | |
| MATERIAL: | FINISH: | SIZE: A1 | CAGE CODE: 00779 DRAWING NO: 1971845 SCALE: 8:1 SHEET 3 OF 6 REV B |

| LOC | | DIST | | REVISIONS | | | |
|-----|-----|-------------|------|-----------|------|--|--|
| P | LTN | DESCRIPTION | DATE | OWN | APVD | | |
| - | - | SEE SHEET 1 | - | - | - | | |

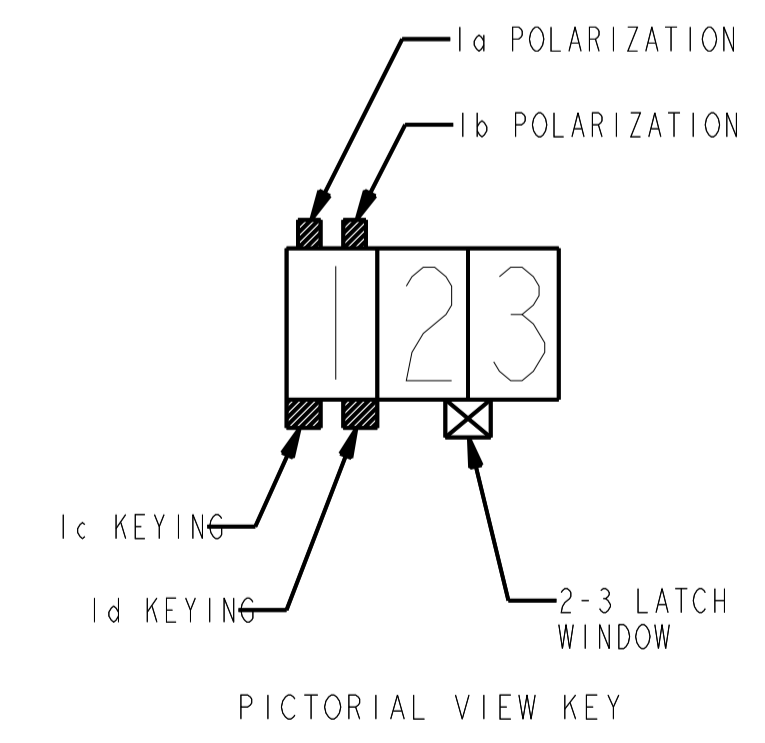
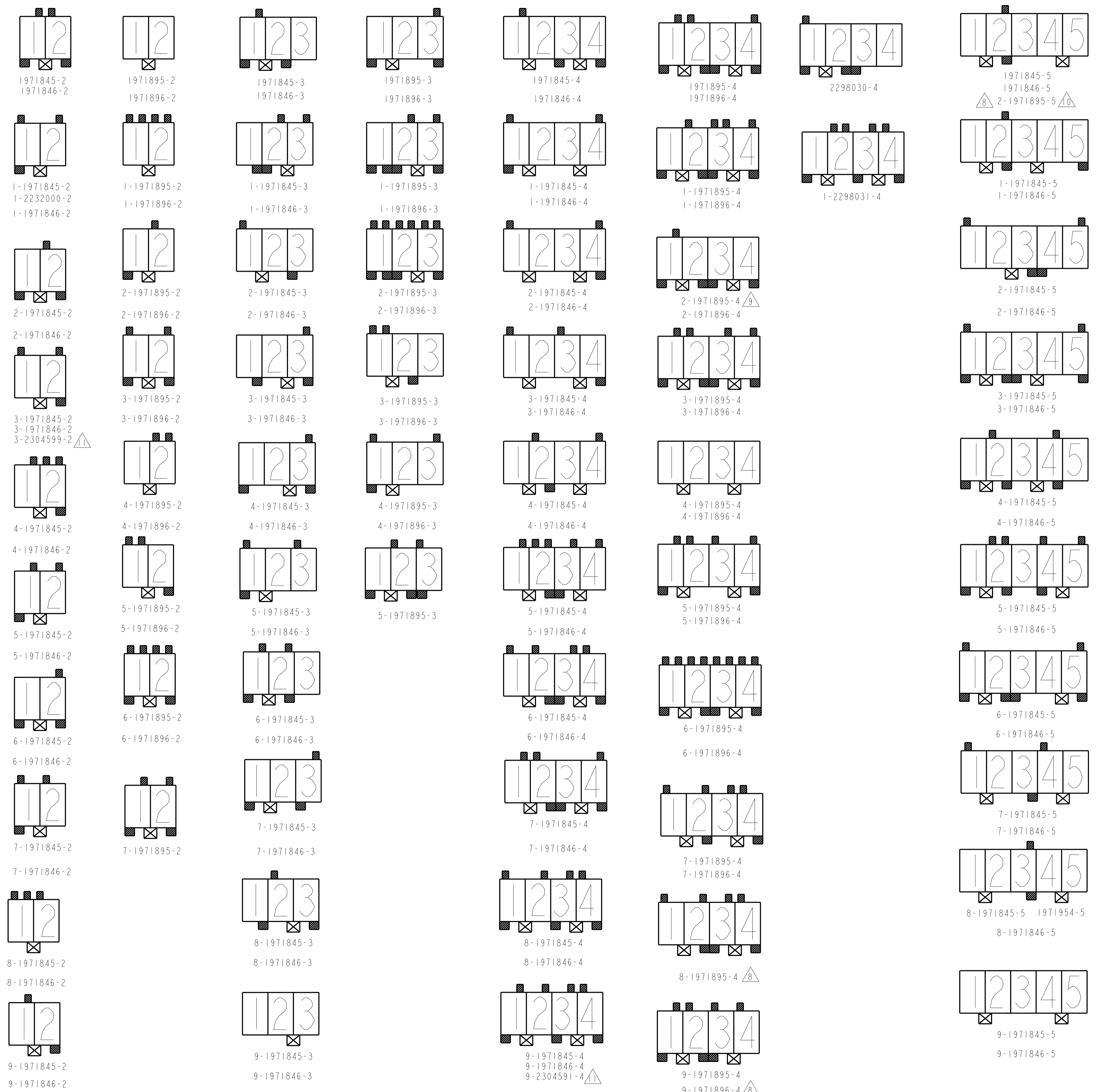

| | | | |
|--|--|---|---|
| THIS DRAWING IS A CONTROLLED DOCUMENT. | | OWN: HRP 21Jan2013 | TE Connectivity |
| DIMENSIONS: mm | | CHK: HAPYE 21Jan2013 | |
| TOLERANCES UNLESS OTHERWISE SPECIFIED: | | APVD: YHM 21Jan2013 | NAME: RAST 5 TAB HEADER ASSY DIN STYLE, TH, VERTICAL |
| 0 PLC ± 1 PLC ±0.25 2 PLC ± 3 PLC ± 4 PLC ± ANGLES ±° | | PRODUCT SPEC: 108-106080 APPLICATION SPEC: | |
| MATERIAL: - | | WEIGHT: - | SIZE: A1 CAGE CODE: 00779 DRAWING NO: 1971845 |
| FINISH: - | | Customer Drawing | RESTRICTED TO: - SCALE: 8:1 SHEET 4 OF 6 REV B |

| LOC | | DIST | | REVISIONS | | | |
|-----|-----|-------------|------|-----------|------|--|--|
| P | LTN | DESCRIPTION | DATE | DWN | APVD | | |
| - | - | SEE SHEET 1 | - | - | - | | |

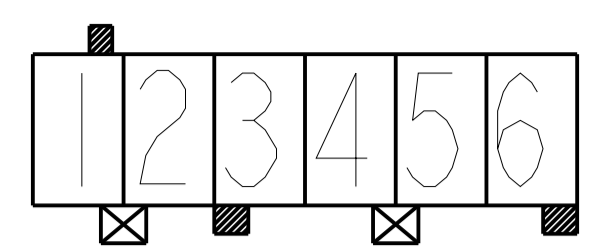

1971845-6
1971846-6

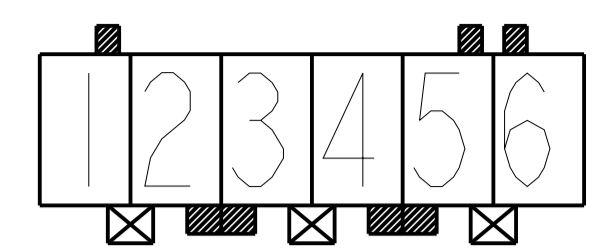

1971895-6
1971896-6

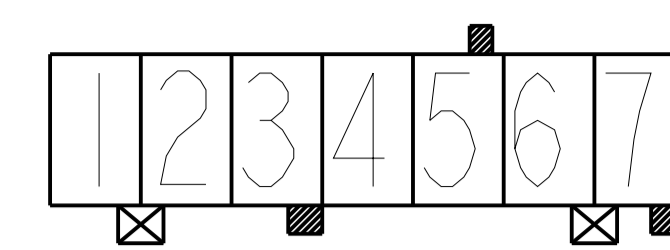

1971845-7
1971846-7

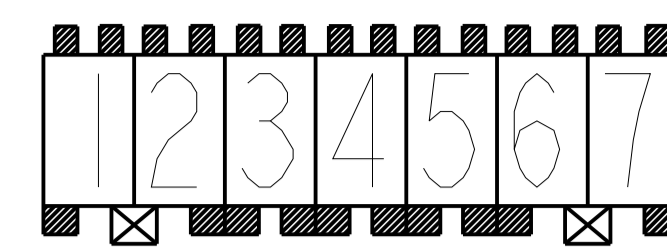

1971895-7
1971896-7

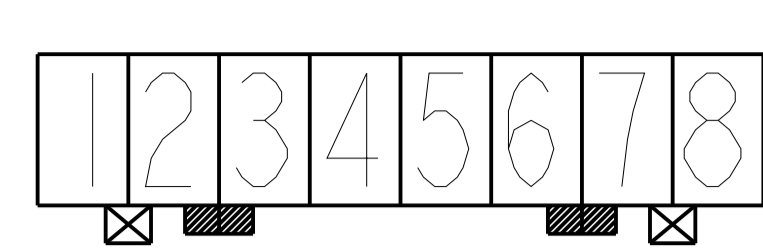

1971845-8
1971846-8

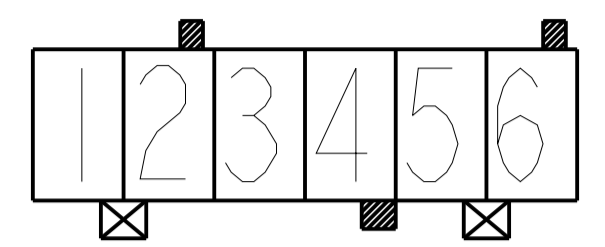

1-1971845-6
1-1971846-6

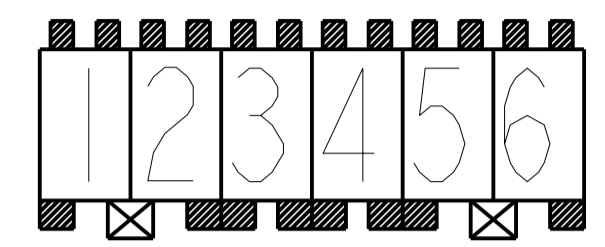

1-1971895-6
1-1971896-6

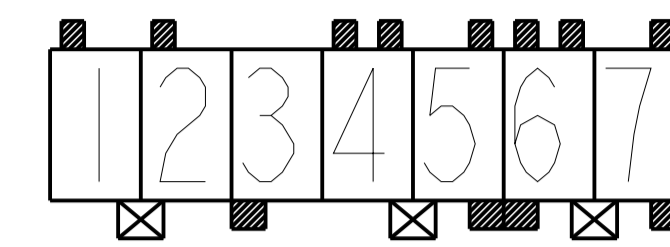

1-1971845-7
1-1971846-7

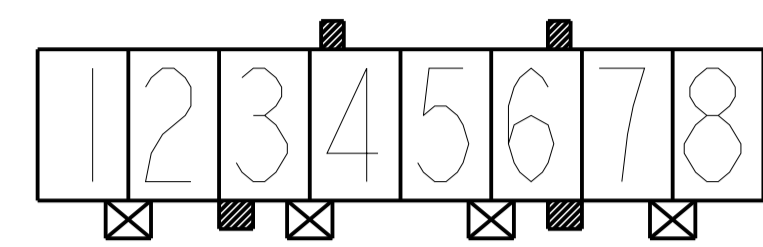

1-1971845-8
1-1971846-8

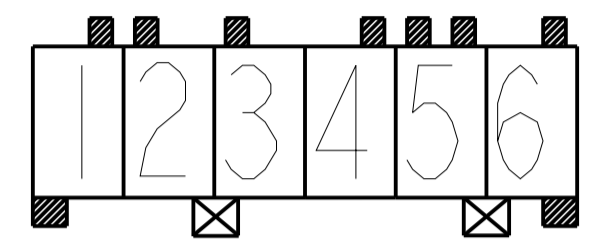

2-1971845-6
2-1971846-6

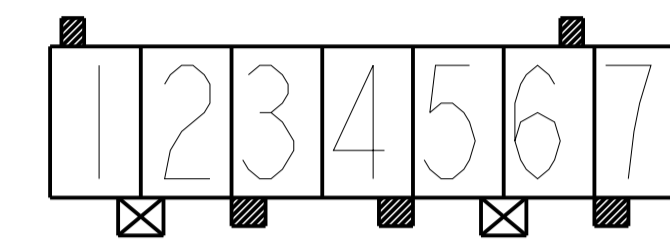

2-1971845-7
2-1971846-7

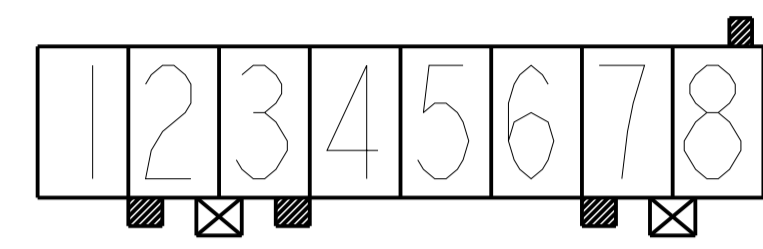

2-1971845-8
2-1971846-8

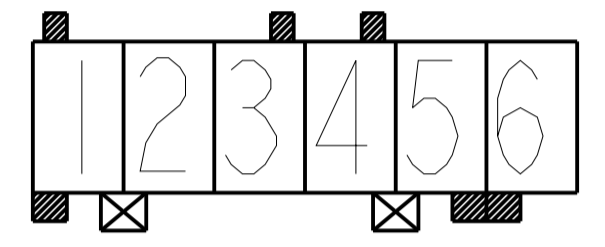

3-1971845-6
3-1971846-6

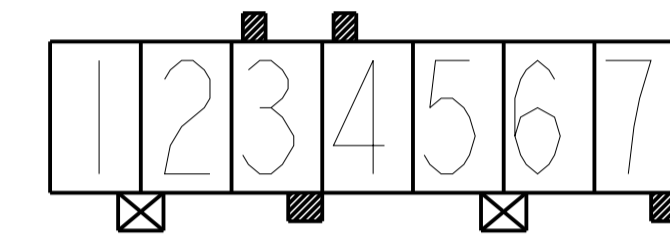

3-1971845-7
3-1971846-7

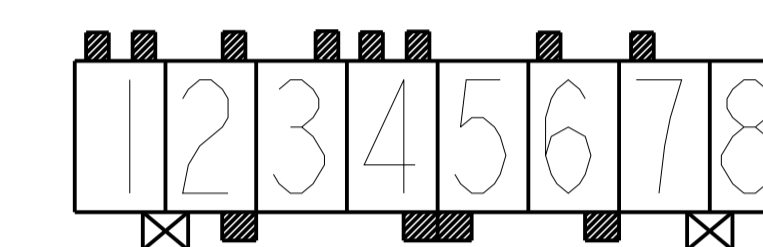

3-1971845-8
3-1971846-8

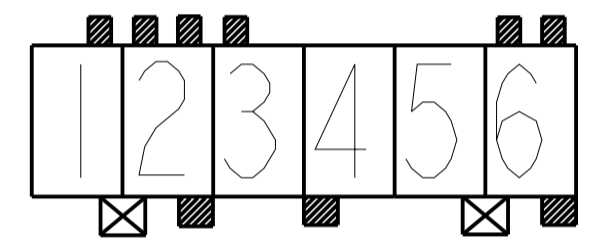

4-1971845-6
4-1971846-6

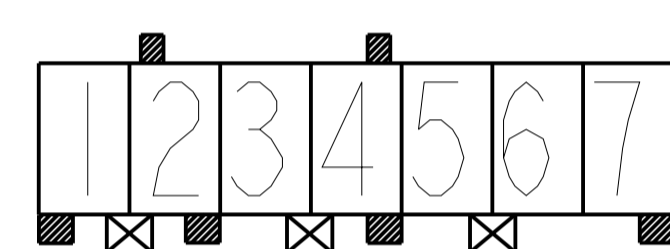

4-1971845-7
4-1971846-7

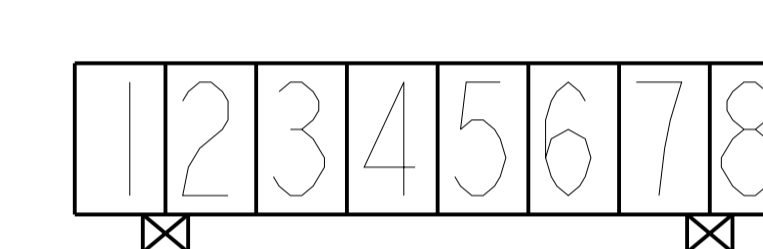

4-1971845-8
4-1971846-8

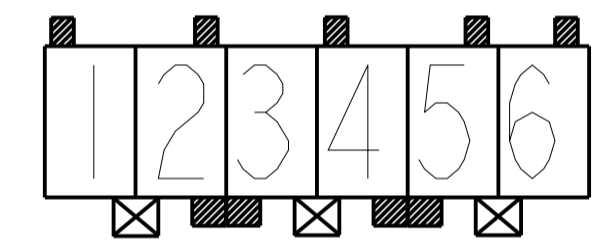

5-1971845-6
5-1971846-6

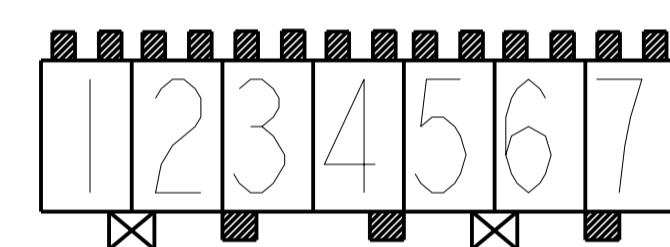

5-1971845-7
5-1971846-7

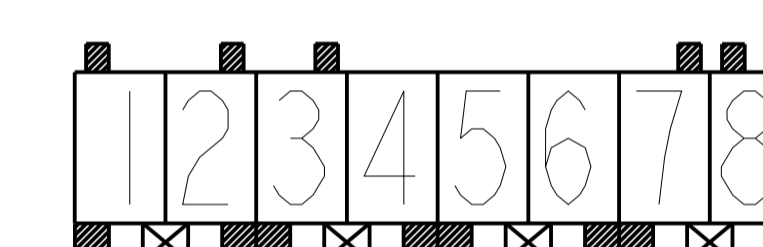

5-1971845-8
5-1971846-8

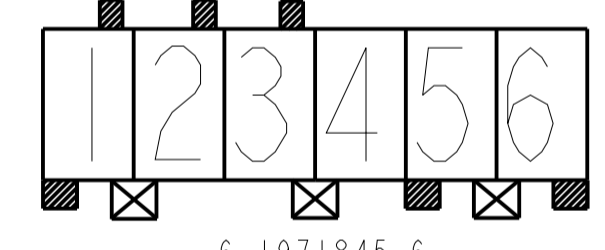

6-1971845-6
6-1971846-6

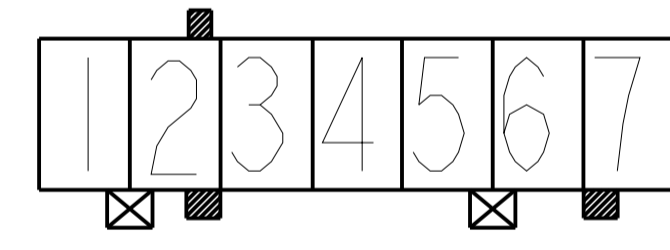

6-1971845-7 1971946-7
6-1971846-7

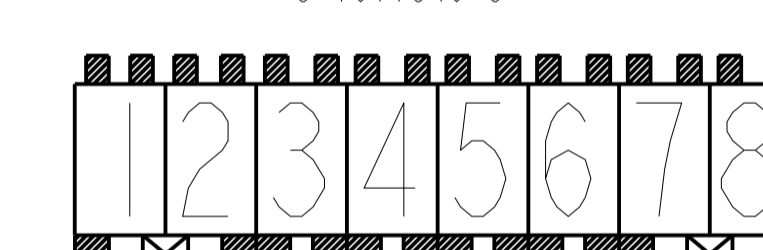

6-1971845-8
6-1971846-8

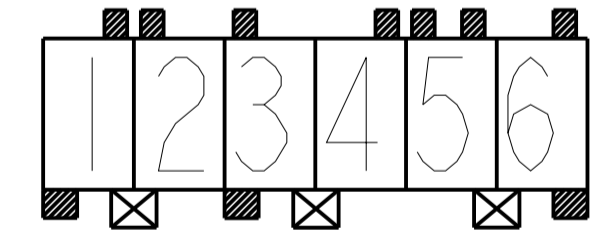

7-1971845-6
7-1971846-6

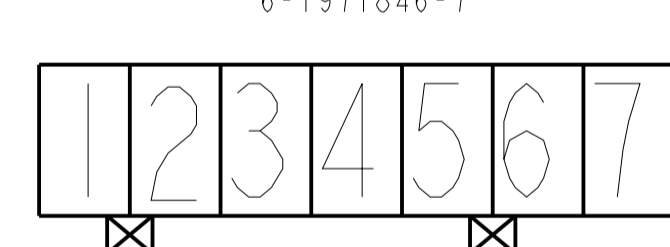

7-1971845-7
7-1971846-7

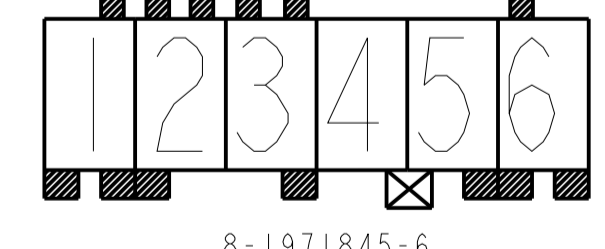

8-1971845-6
8-1971846-6

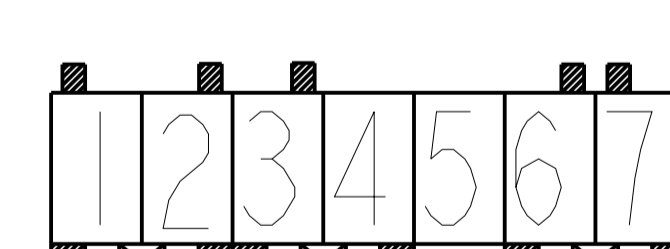

8-1971845-7
8-1971846-7

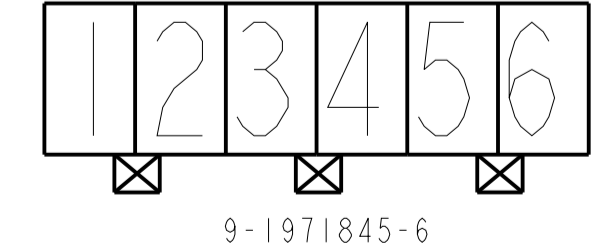

9-1971845-6
9-1971846-6

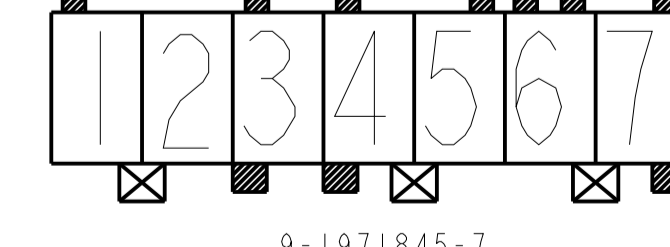

9-1971845-7
9-1971846-7

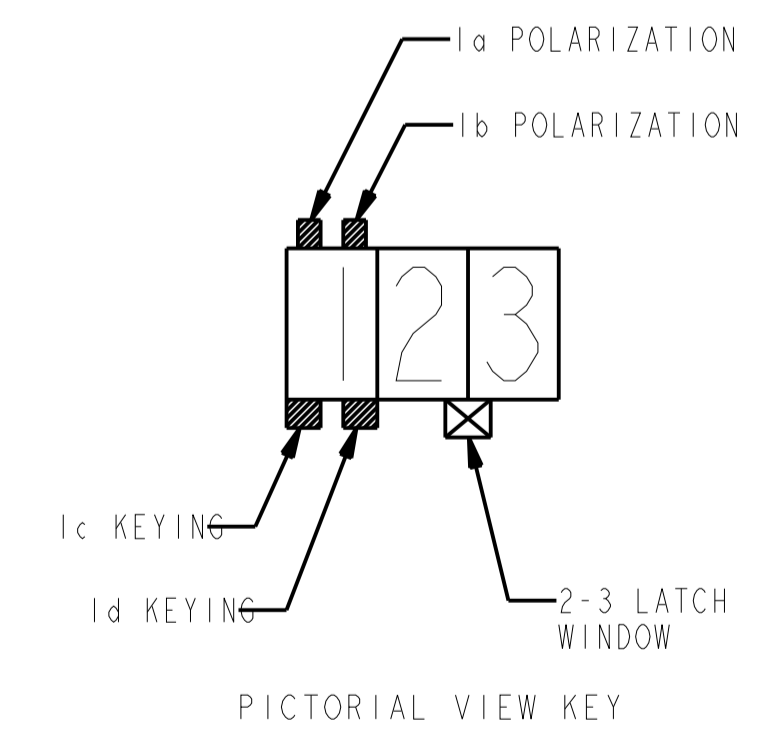

| | | | |
|--|-------------|----------------------|---|
| THIS DRAWING IS A CONTROLLED DOCUMENT. | | DWN: HRP 21Jan2013 | TE Connectivity |
| DIMENSIONS: mm | | CHK: HAPYE 21Jan2013 | |
| TOLERANCES UNLESS OTHERWISE SPECIFIED: | | APVD: YHM 21Jan2013 | NAME: RAST 5 TAB HEADER ASSY DIN STYLE, TH, VERTICAL |
| 0 PLC ± | 1 PLC ±0.25 | PRODUCT SPEC | SIZE: A1 |
| 2 PLC ± | 3 PLC ± | APPLICATION SPEC | CAGE CODE: 00779 |
| 4 PLC ± | ANGLES ± | WEIGHT | DRAWING NO: 1971845 |
| FINISH | | Customer Drawing | RESTRICTED TO |
| | | SCALE: 8:1 | SHEET 5 OF 6 |
| | | | REV B |

| LOC | | DIST | | REVISIONS | | | |
|-----|-----|-------------|------|-----------|------|--|--|
| P | LTN | DESCRIPTION | DATE | DWN | APVD | | |
| - | - | SEE SHEET 1 | - | - | - | | |

FOR ANY KEYING CONFIGURATION, THERE ARE EIGHT COLORS AVAILABLE, BESIDES THE NATURAL COLOR. THERE ARE OTHER SEVEN COLORS, INCLUDE: YELLOW, BLUE, GREY, PURPLE, RED, GREEN, BLACK. THE WHITE VERSION IS PRELIMINARY. THE P/N OF THE COLOR CONNECTOR ARE BASED ON THE NATURAL CONNECTOR. THE PREFIX AND POSTFIX ARE THE SAME FOR THE SAME KEYING CONFIGURATION, BUT THE BASE NUMBERS ARE DIFFERENT ACCORDING TO DIFFERENT COLOR. THE FOLLOWING SHOWS WHAT'S THE P/N FOR COLOR CONNECTOR



| COLOR | PART NUMBER OF THE CONNECTOR | | | | COMMENTS |
|---------|--|-------------|-------------------------|-------------|--|
| | WITH MATT TIN PLATING CONTACT (SPECIAL P/N: 2-1971895-4, 2-1971845-6, 6-1971845-5, 5-1971845-8 AND 2-1971895-5 ARE WITH BRIGHT TIN) | | WITH AG PLATING CONTACT | | |
| NATURAL | #-1971845-# | #-1971895-# | #-1971846-# | #-1971896-# | THE DETAIL P/N FOR DIFFERENT KEYING SEE SHEET 2-5 |
| RED | #-1971946-# | #-1971948-# | #-1971947-# | #-1971949-# | THE PREFIX AND POSTFIX ARE THE SAME WITH THE P/N OF THE NATURAL CONNECTOR FOR THE SAME KEYING, POLARIZATION, LATCH WINDOW CONFIGURATION. JUST THE BASE NUMBERS ARE DIFFERENT BASED ON DIFFERENT COLOR. # CAN BE THE NUMBER FROM 0 TO 9. BUT THERE ARE TWO EXEMPTION PART NUMBERS. 1971954-5 (BLUE) AND 1971946-7 (RED) |
| BLUE | #-1971954-# | #-1971956-# | #-1971955-# | #-1971957-# | |
| YELLOW | #-2232008-# | #-2232010-# | #-2232009-# | #-2232011-# | |
| BLACK | #-2232000-# | #-2232002-# | #-2232001-# | #-2232003-# | |
| GREY | #-2232016-# | #-2232018-# | #-2232017-# | #-2232019-# | |
| GREEN | #-1971962-# | #-1971964-# | #-1971963-# | #-1971965-# | |
| PURPLE | #-2232024-# | #-2232026-# | #-2232025-# | #-2232027-# | |
| WHITE | #-2232289-# | #-2232291-# | #-2232290-# | #-2232292-# | |

THERE ARE TWO EXEMPTION FOR COLOR PART NUMBERS



FOR EXAMPLE, IF A CONNECTOR WITH THE CONFIGURATION AS BELOW, AND WITH MATT TIN PLATING CONTACT, IN THE SHEET 4, WE CAN FIND THE RELATED CONNECTOR P/N WITH NATURAL COLOR IS 1-1971845-4, THEN WE CAN LOOK IN THE ABOVE TABLE TO FIND THE CONNECTOR P/N WITH RED COLOR IS 1-1971946-3



| COLOR | PART NUMBER OF THE CONNECTOR | | COMMENTS |
|---------|---------------------------------|-------------|--|
| | WITH BRIGHT TIN PLATING CONTACT | | |
| NATURAL | #-2232906-# | #-2232907-# | THE KEYING, POLARIZATION AND LATCH WINDOW CONFIGURATION ARE SAME AS THE MATT TIN CONNECTOR WITH THE SAME PREFIX AND POSTFIX FOR EACH COLOR. FOR EXAMPLE: 2232906-4 AND 1971845-4 HAVE SAME KEYING, POLARIZATION AND LATCH WINDOW CONFIGURATION. 2232907-4 AND 1971895-4 HAVE SAME KEYING, POLARIZATION AND LATCH WINDOW CONFIGURATION. THE DETAIL KEYING, POLARIZATION AND LATCH WINDOW CONFIGURATION FOR EACH P/N, PLEASE SEE SHEET 2-5 |
| RED | #-2232908-# | #-2232909-# | |
| BLUE | #-2232910-# | #-2232911-# | |
| YELLOW | #-2232912-# | #-2232913-# | |
| BLACK | #-2232914-# | #-2232915-# | |
| GREY | #-2232916-# | #-2232917-# | |
| GREEN | #-2232918-# | #-2232919-# | |
| PURPLE | #-2232920-# | #-2232921-# | |
| WHITE | #-2232922-# | #-2232923-# | |

| | | | |
|---|-----------|---|--|
| THIS DRAWING IS A CONTROLLED DOCUMENT. | | DWN: HRP 21Jan2013 | TE Connectivity |
| DIMENSIONS: mm | | CHK: HAPYE 21Jan2013 | |
| TOLERANCES UNLESS OTHERWISE SPECIFIED: | | APVD: YIM 21Jan2013 | |
| 0 PLC ± 1 PLC ± 2 PLC ±0.25 3 PLC ± 4 PLC ± ANGLES ±2° | | PRODUCT SPEC: 108-106080 APPLICATION SPEC: | |
| MATERIAL: - | FINISH: - | WEIGHT: - | NAME: RAST 5 TAB HEADER ASSY DIN STYLE, TH, VERTICAL SIZE: A1 CAGE CODE: 00779 DRAWING NO: 1971845 RESTRICTED TO: - |
| Customer Drawing | | | SCALE: 8:1 SHEET: 6 OF 6 REV: B |

Mouser Electronics

Authorized Distributor

Click to View Pricing, Inventory, Delivery & Lifecycle Information:

[TE Connectivity:](#)

[3-1971845-2](#)