

THIS DRAWING IS UNPUBLISHED. RELEASED FOR PUBLICATION
 © COPYRIGHT copyright.d8Te- ALL RIGHTS RESERVED.

| REVISIONS | | | | |
|-----------|-----|----------------------------|-----------|-------|
| P | LTR | DESCRIPTION | DATE | APVD |
| B | | RELEASED PER ECR-21-100757 | 04MAR2021 | SK DZ |
| B2 | | RELEASED PER ECR-21-121051 | 23NOV2021 | SK DZ |

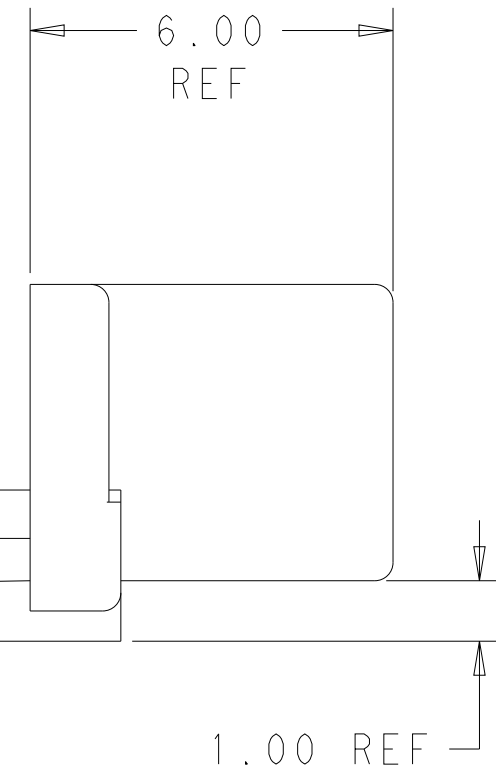
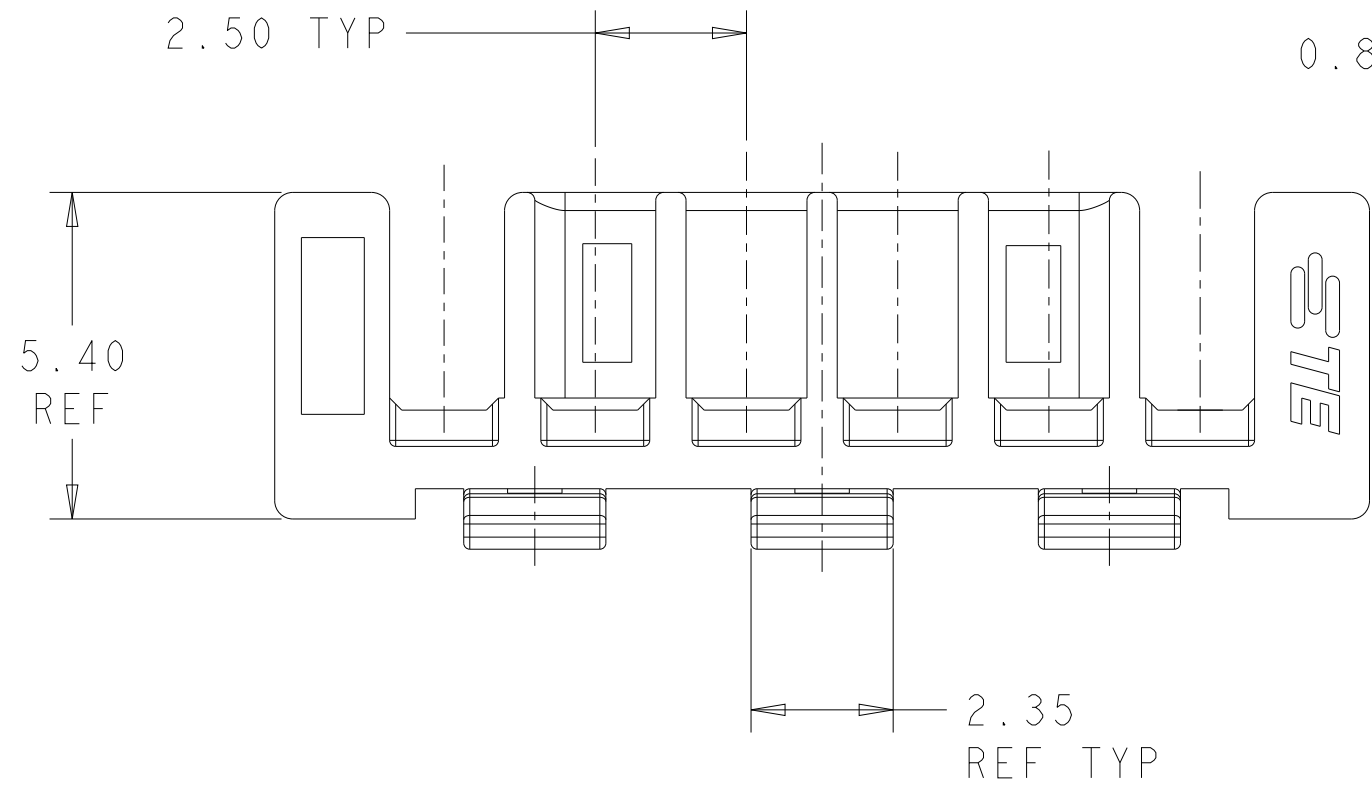
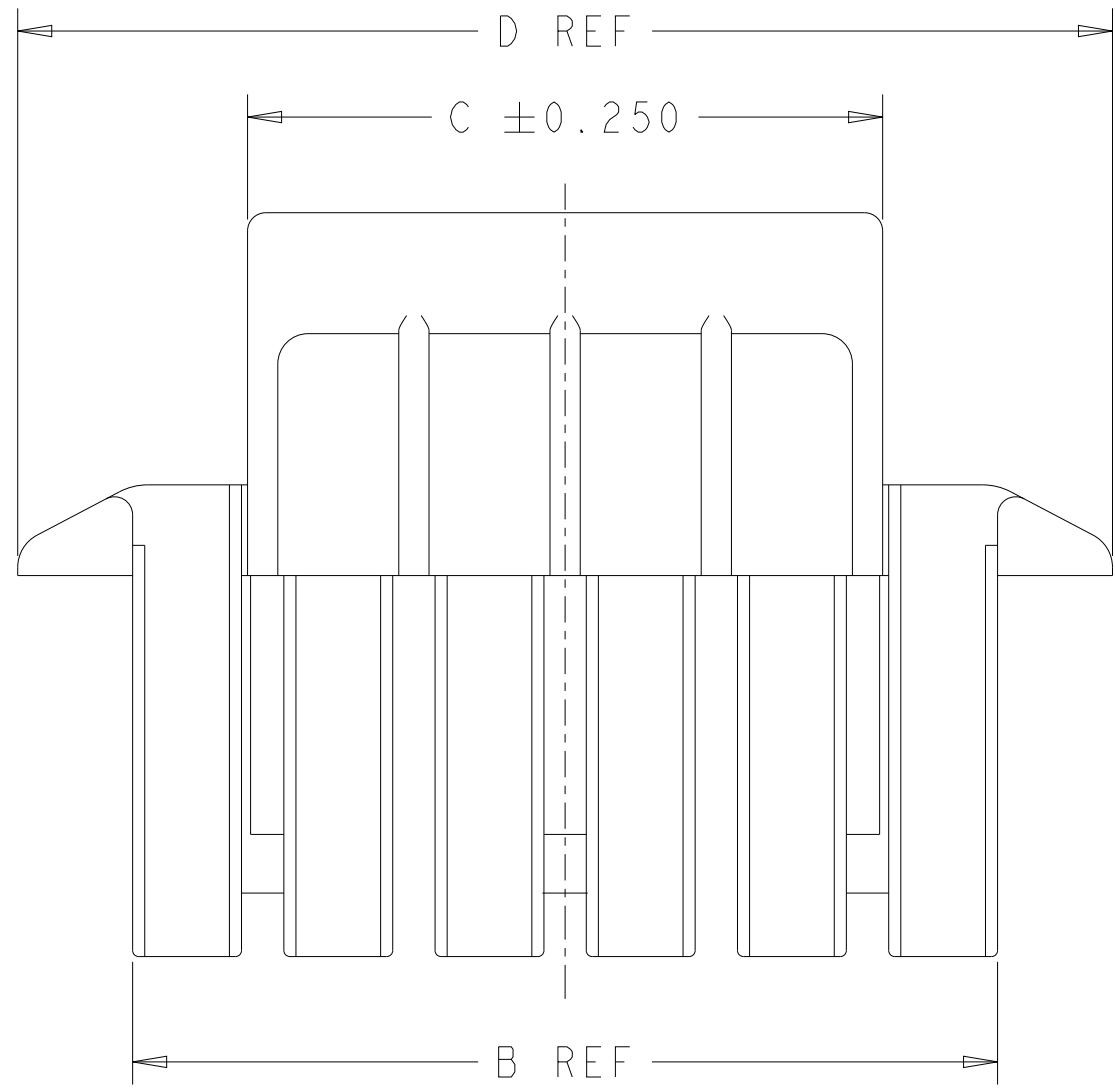

- 1 MATERIAL; HIGH PERFORMANCE RISIN, UL94-V0, GLASS FILLED, COLOR - BLACK
- 2 MATES WITH HOUSING 1969442-(X)

| | | | | |
|-------|-------|-------|-----------|-------------|
| 53.1 | 10.5 | 49.3 | 20 | 2-1969825-0 |
| 50.6 | 13 | 46.8 | 19 | 1-1969825-9 |
| 48.1 | 10.5 | 44.3 | 18 | 1-1969825-8 |
| 45.6 | 13 | 41.8 | 17 | 1-1969825-7 |
| 43.1 | 10.5 | 39.3 | 16 | 1-1969825-6 |
| 40.6 | 13 | 36.8 | 15 | 1-1969825-5 |
| 38.1 | 10.5 | 34.3 | 14 | 1-1969825-4 |
| 35.6 | 13 | 31.8 | 13 | 1-1969825-3 |
| 33.1 | 10.5 | 29.3 | 12 | 1-1969825-2 |
| 30.6 | 13 | 26.8 | 11 | 1-1969825-1 |
| 28.1 | 10.5 | 24.3 | 10 | 1-1969825-0 |
| 25.6 | 13 | 21.8 | 9 | 1969825-9 |
| 23.1 | 10.5 | 19.3 | 8 | 1969825-8 |
| 20.6 | 13 | 16.8 | 7 | 1969825-7 |
| 18.1 | 10.5 | 14.3 | 6 | 1969825-6 |
| 16.7 | 13 | 11.8 | 5 | 1969825-5 |
| 14.2 | 10.5 | 9.3 | 4 | 1969825-4 |
| 11.7 | 8 | 6.8 | 3 | 1969825-3 |
| 8.1 | 5.5 | 4.3 | 2 | 1969825-2 |
| DIM D | DIM C | DIM B | POSITIONS | PART NO. |

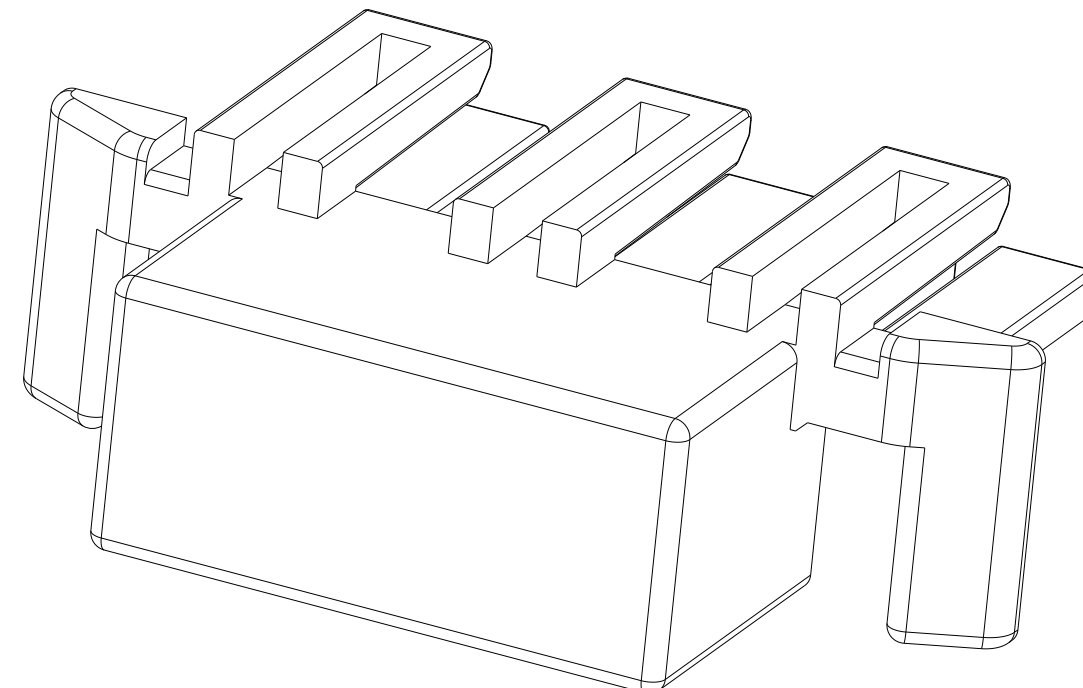
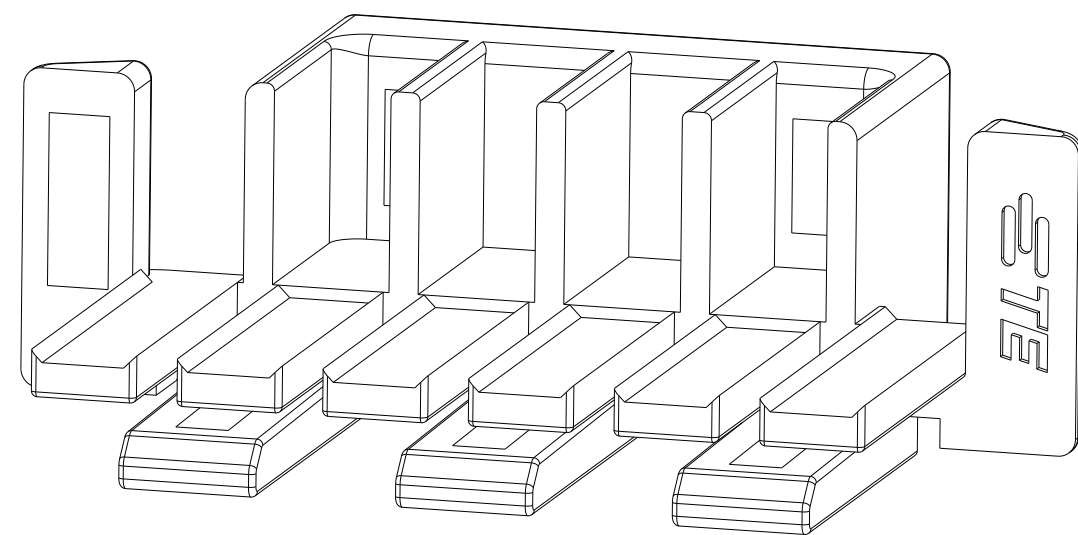

THIS DRAWING IS A CONTROLLED DOCUMENT.

| | | | |
|-------------|--|------------------|-------------------|
| DIMENSIONS: | TOLERANCES UNLESS OTHERWISE SPECIFIED: | DWN | 20-Jan-16 |
| mm | 0 PLC ± | CHK | JR RUTH 20JAN16 |
| | 1 PLC ± | APVD | D. FAROLE 20JAN16 |
| | 2 PLC ±0.13 | PRODUCT SPEC | |
| | 3 PLC ± | APPLICATION SPEC | |
| | 4 PLC ± | WEIGHT | |
| | ANGLES ± | CUSTOMER DRAWING | |
| | FINISH | SCALE | N/A |

NAME: ECONOMY POWER 2.5 TPA RETAINER

SIZE: A2 CAGE CODE: - DRAWING NO: C-1969825 RESTRICTED TO: -

SHEET 1 OF 2 REV B2

THIS DRAWING IS UNPUBLISHED. RELEASED FOR PUBLICATION
COPYRIGHT copyright.d8Te- ALL RIGHTS RESERVED.

| REVISIONS | | | | | |
|-----------|-----|-------------|------|-----|------|
| P | LTR | DESCRIPTION | DATE | DWN | APVD |
| - | - | SEE SHEET 1 | - | - | - |
| | | | | | |
| | | | | | |

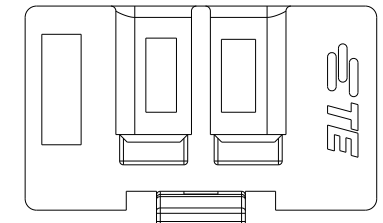

1969825-2

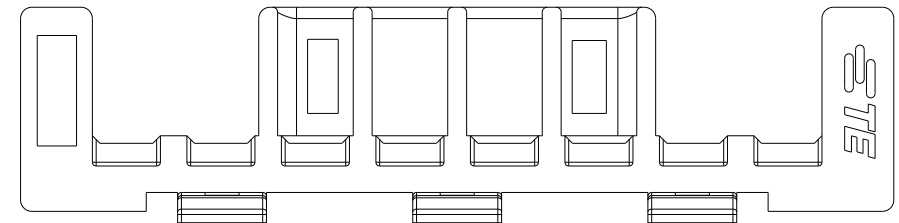

1969825-8

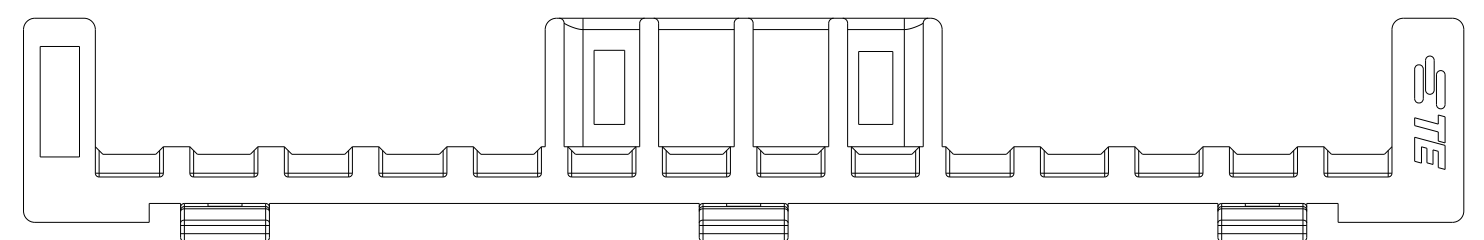

1-1969825-4

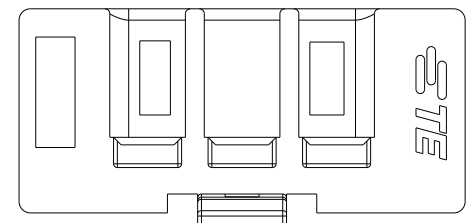

1969825-3

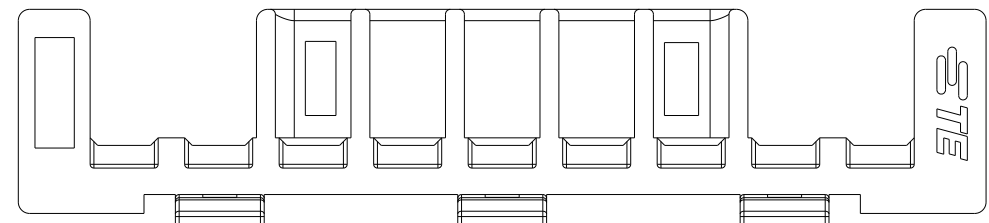

1969825-9

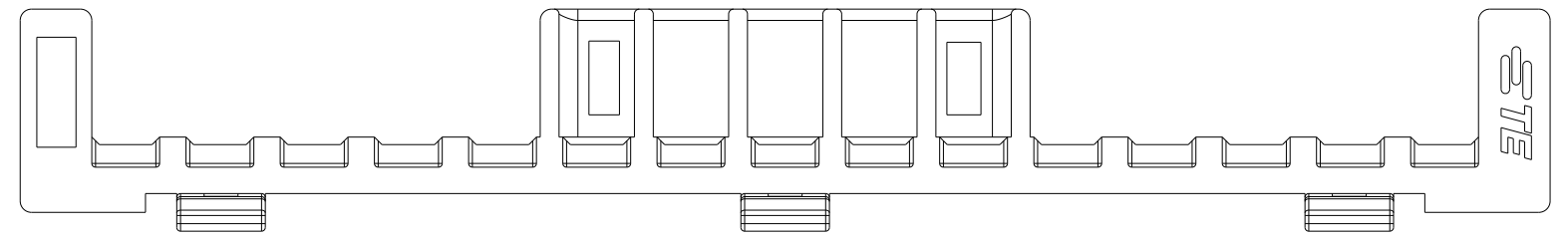

1-1969825-5

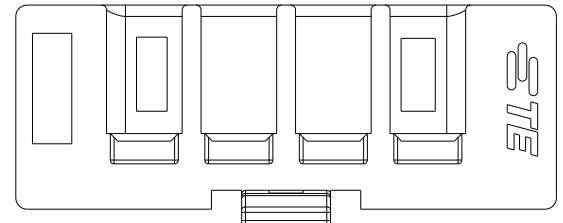

1969825-4

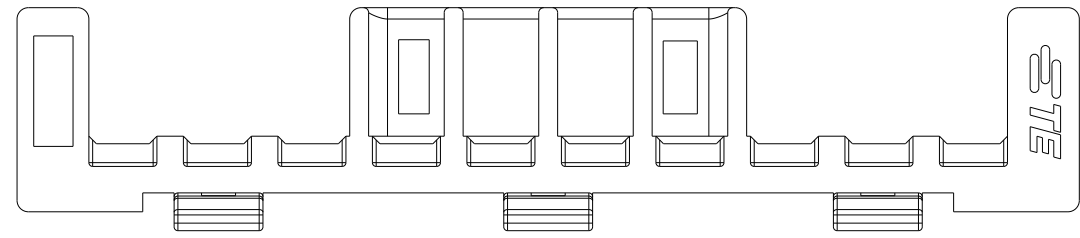

1-1969825-0

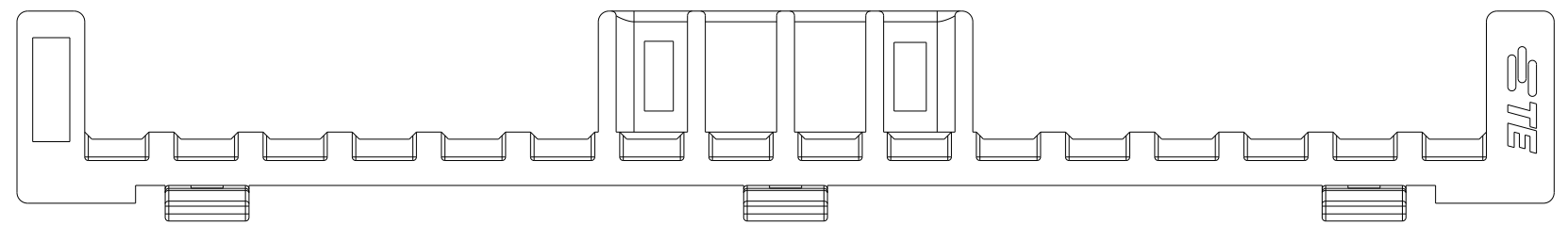

1-1969825-6

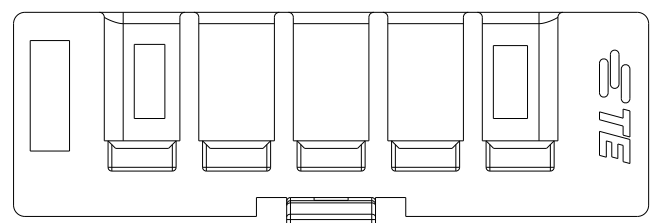

1969825-5

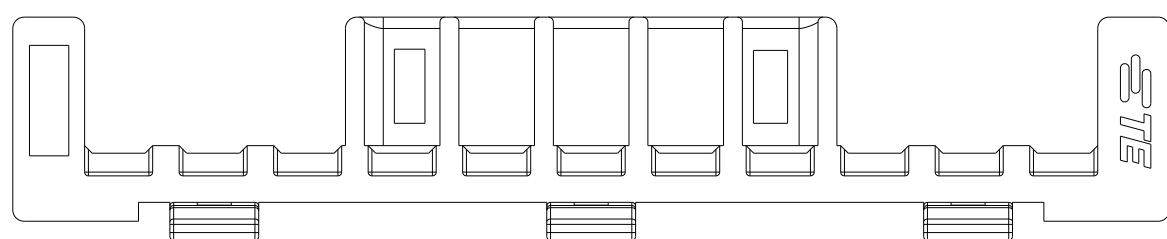

1-1969825-1

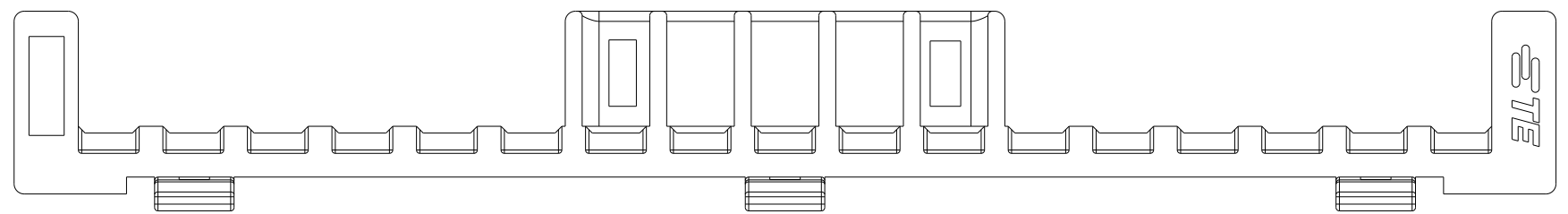

1-1969825-7

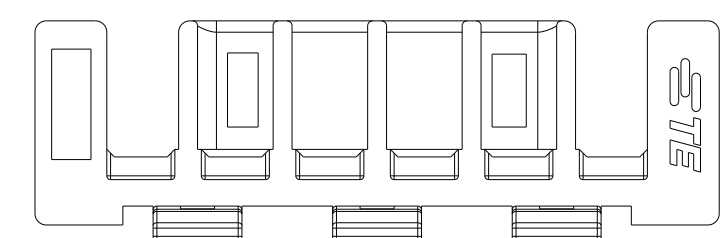

1969825-6

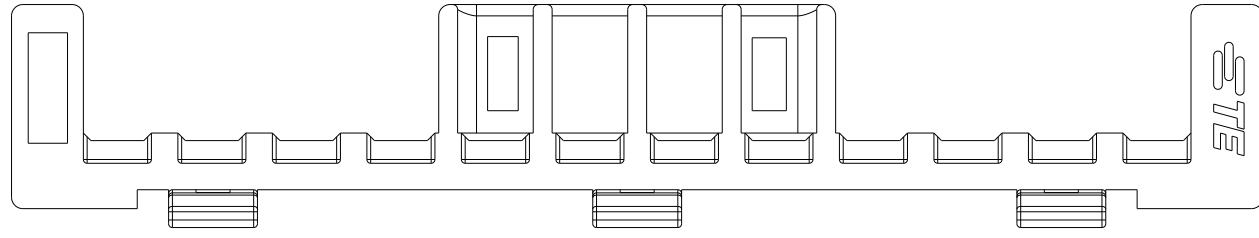

1-1969825-2

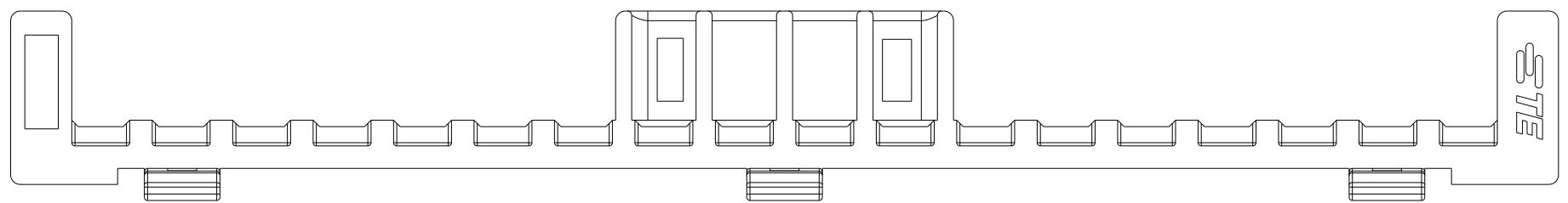

1-1969825-8

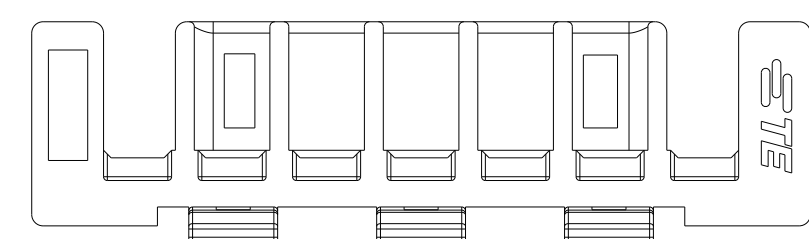

1969825-7

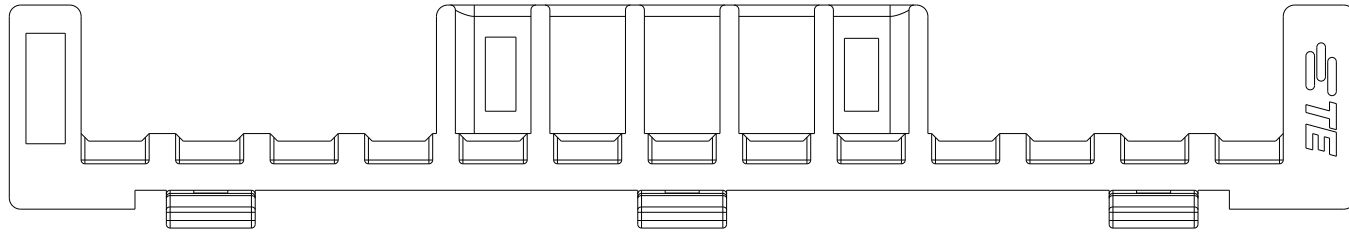

1-1969825-3

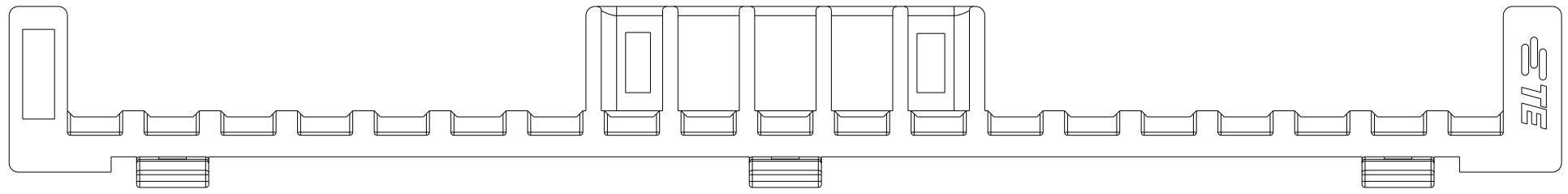

1-1969825-9

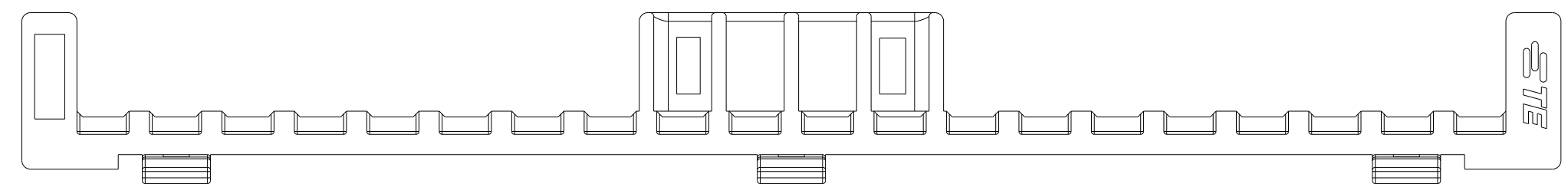

2-1969825-0

| | | | | | | | | | | | |
|--|--|--------------|-----------|------------------|---------------------|------------|--|--------------------------------|-----------|-----|---------------|
| THIS DRAWING IS A CONTROLLED DOCUMENT. | | DWN | JR RUTH | 20-Jan-16 | TE Connectivity | NAME | | ECONOMY POWER 2.5 TPA RETAINER | | | |
| DIMENSIONS: | | CHK | D. FAROLE | 20JAN16 | | SIZE | | A2 | CAGE CODE | - | RESTRICTED TO |
| mm | | APVD | D. FAROLE | 20JAN16 | | DRAWING NO | | C-1969825 | | - | |
| TOLERANCES UNLESS OTHERWISE SPECIFIED: | | PRODUCT SPEC | | APPLICATION SPEC | | WEIGHT | | SCALE | | N/A | |
| 0 PLC ± | | MATERIAL | | CUSTOMER DRAWING | | SHEET | | 2 | | OF | |
| 1 PLC ± | | | | | | REV | | B2 | | | |
| 2 PLC ±0.13 | | | | | | | | | | | |
| 3 PLC ± | | | | | | | | | | | |
| 4 PLC ± | | | | | | | | | | | |
| ANGLES ± | | | | | | | | | | | |
| FINISH ± | | | | | | | | | | | |

Mouser Electronics

Authorized Distributor

Click to View Pricing, Inventory, Delivery & Lifecycle Information:

[TE Connectivity:](#)

[1969825-6](#)