

H2TD3680

Digital RH/T module

SPECIFICATIONS

- Combo sensor (Relative Humidity, Air and Windscreen Temperature)
- Optimized design for high RH, high T°C environment
- Digital output as per LIN protocol J2602
- Rugged, automotive graded sensor
- High resistance to chemicals
- Optional and customizable Cover
- Dew Point through internal calculation

Based on the rugged MEAS FRANCE humidity sensor, H2TD3680 is a dedicated humidity and temperature plug and play transducer designed for Truck fogging prevention applications where a reliable and accurate measurement is needed.

H2TD3680 is designed for high volume and demanding applications.

FEATURES

- Demonstrated reliability and long term stability
- Reliability not affected by repeated condensation

APPLICATIONS

- Trucks and off road
- Cabin fogging prevention

PERFORMANCE SPECS

Characteristics	Value			Unit
	Min	Typ	Max	
Supply Voltage (Peak)	9	12*	16	V
Current consumption		10	15	mA
Humidity operating range	0		100	%RH
Temperature Operating Range	-40		+85	°C
Storage Temperature	-40		+125	°C
LIN baudrate		9600		Bps

*Supply Voltage Option: 24V Typ

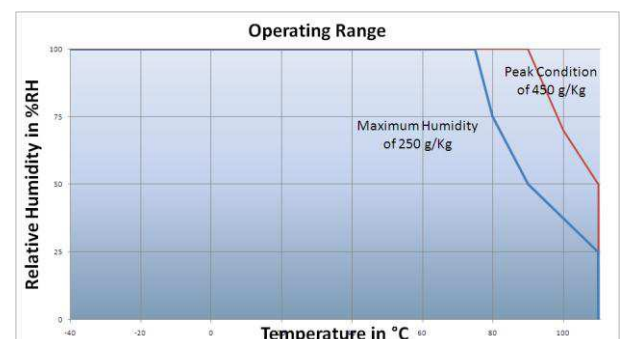

FUNCTION

CABIN FOGGING PREVENTION

(A) Scope

Fog on the windscreen will impact dramatically the driver’s field of vision.

With the increased use of air recirculation which uses a continuous low air flow along the windscreen, fogging is becoming more of a concern.

Air recirculation prevents the discharging of moisture out of the passenger compartment and accentuates fogging through the accumulation of moisture from various sources.

(B) Root Cause

Fogging on the windshield occurs when the glass temperature is below the dew point temperature of air.

(C) Fogging Scenarios

1- Rise of humidity in the passenger compartment, which in turn increases the dew point.

Contribution factors:

- Recirculation is closed, damper must be re-opened before fogging.
- The IC engine is stopped (Stop & Start / Hybrids), AC is off for a too long period of time.
- The occupant (new) comes inside the car with wet clothes, objects, AC must be activated before fogging.
- Someone opens a window (summer time), allow external humidity to enter in the cabin, AC must be activated before fogging.

(C) Fogging Scenarios (Context)

2- Decrease of windshield glass temperature:

Contribution factors :

- There is a slow or sudden change in sun load on the car surface (tunnel, night time, others), damper must be re-opened, AC must be activated.
- There is a sudden rain, snow fall (which will also increase the humidity content of the air at inlet), AC must be activated.
- There is a change in car speed (increase, typ. Highway), damper must be re-opened, AC must be activated.

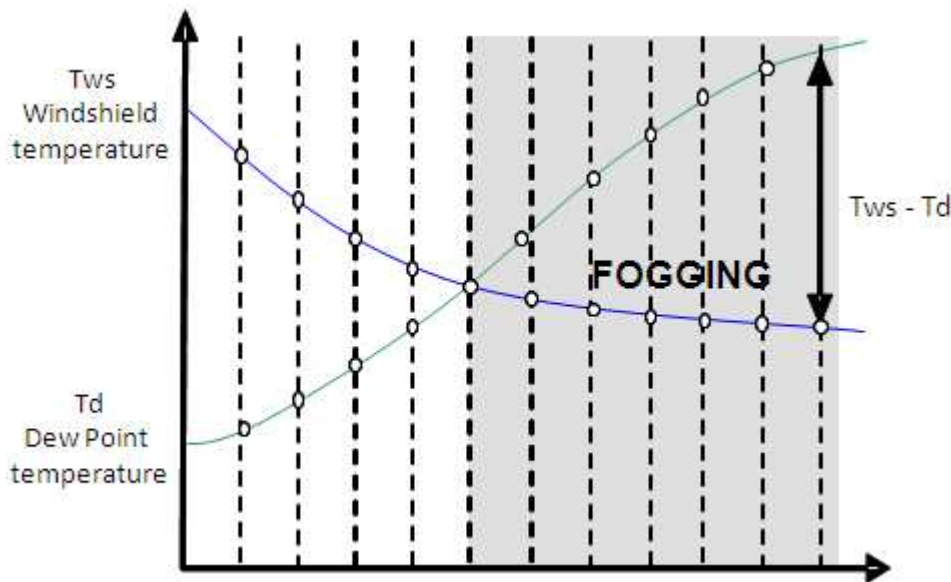

Defogging and fogging prevention

When fogging occurs it's already too late: as shown on this sketch, defogging the driver's field of vision go through different line-step, which takes times and represent a safety problem and a waste of energy from the HVAC system.

This confirms the importance of fogging prevention systems:

- Avoid fogging appearance and improve safety.
- Avoid defogging phase and save energy.
- Preventing to have to do fast defogging, will maintain perception of comfort (without sudden flow of air with different temperature gradients)

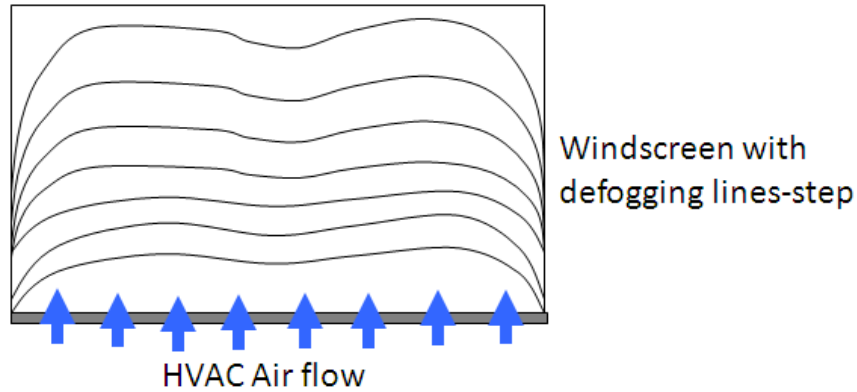

Working principle:

Compare Windshield surface temperature (T_{ws}) with Dew Point temperature measurement (T_d)
 When the glass temperature falls below the dew point temperature of air, fogging conditions are met.

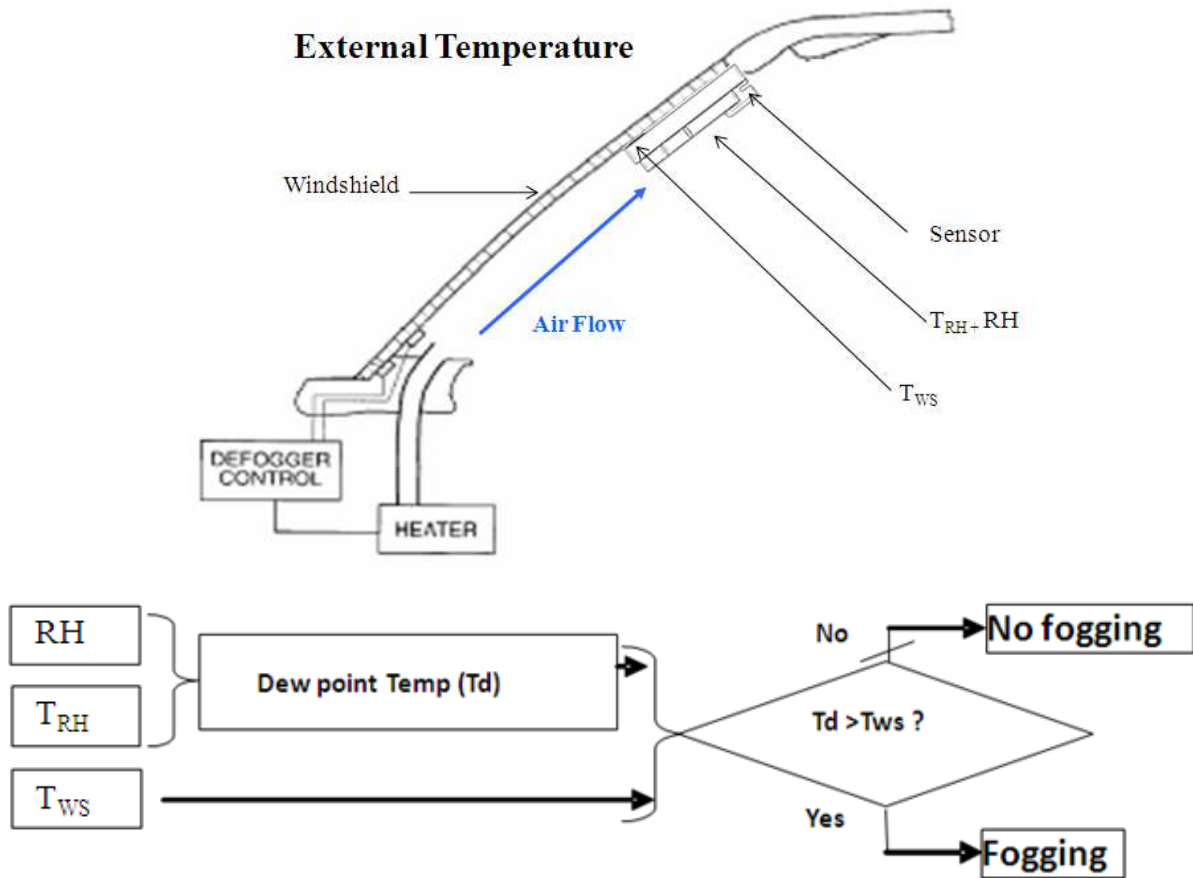

BLOCK DIAGRAM / TYPICAL PERFORMANCE CURVES

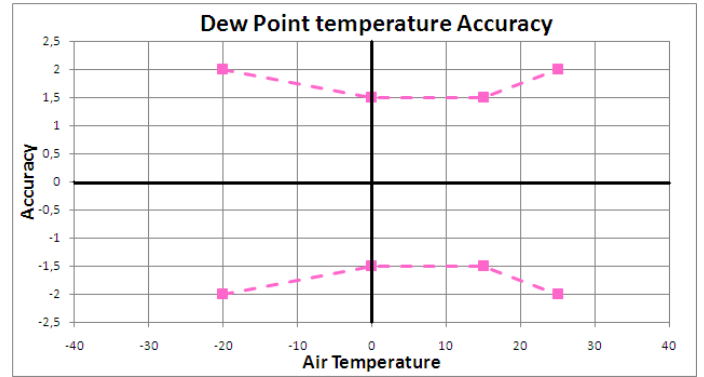
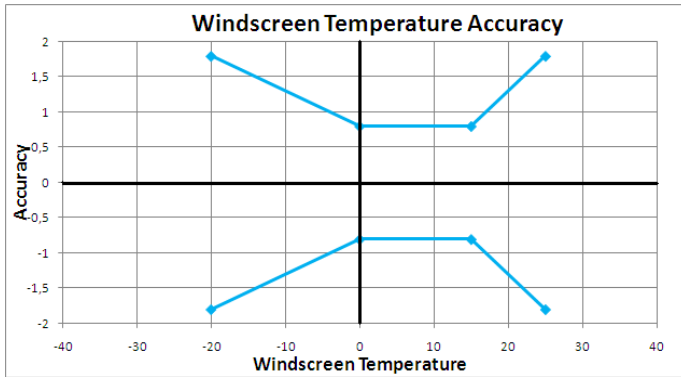
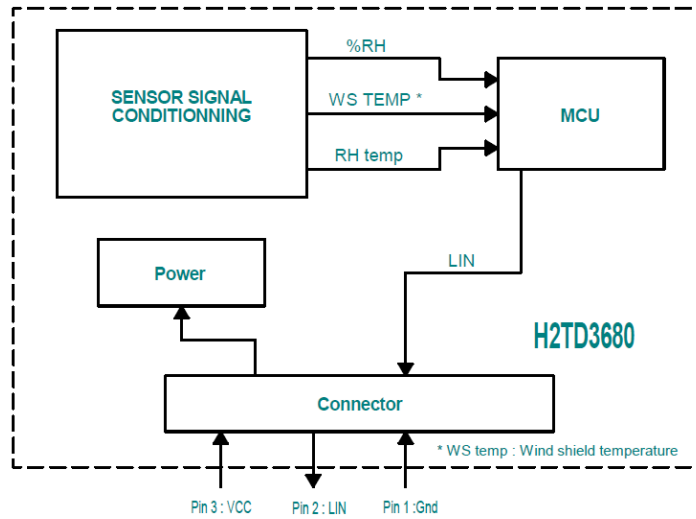

LIN Product Information		
ID	NAME	ID Code
Supplier ID	MEAS	0x7E
Function ID	HUM_SENS	0x0026
Variant ID	Variant	0x01

Message Identifier				
From	Bytes	Name	NAD	Frame ID
Slave Response	8	Humidity Sensor Response Frame	0x6C	0x30

Message Identifier Implementation Book															
D1								D2	D3	D4	D5	D6	D7	D8	
B1	B2	B3	B4	B5	B6	B7	B8	Glass Temperature		Air Temperature		Dew point Temperature		Relative Humidity	
APINF00 *								J2602 Errors Fields							

*APINF00 is set when a failure is detected (RH/Glass T° or Air T°) or if calibration is not valid

TECHNICAL INFORMATION

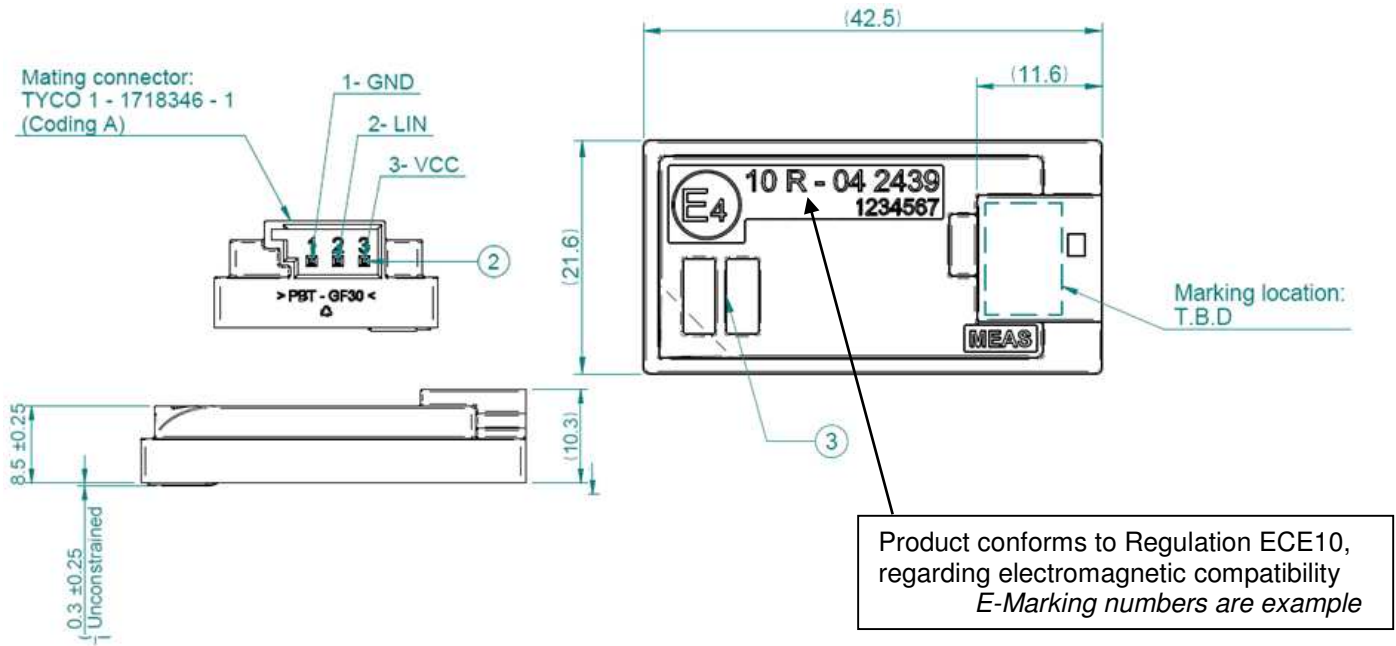

STORAGE INFORMATION

The fogging prevention sensor has to be stored in their original packaging. Introduction of foreign substances in the humidity openings must be prevented. Storage temperature: -40 to +125°C.

MOUNTING RECOMMENDATIONS

1. SYSTEM'S COMPONENTS

1.1. Sensor

Following cares have to be taken before sensor installation:

- Do not touch PTFE membrane.
- Do not touch windscreen temperature sensor.
- If Fogging Sensor is dropped or shocked this parts must be:
 - o Rejected from production line
 - o Replaced by a new one.
- Connector protection: In order to ensure correct electrical contact, connector must be kept free of water, particles, dirt and dust.

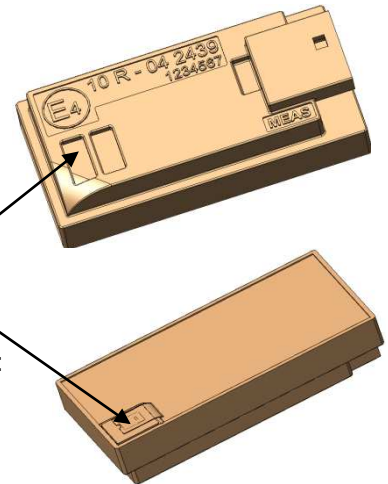

1.2. Bracket with mounting base and clip

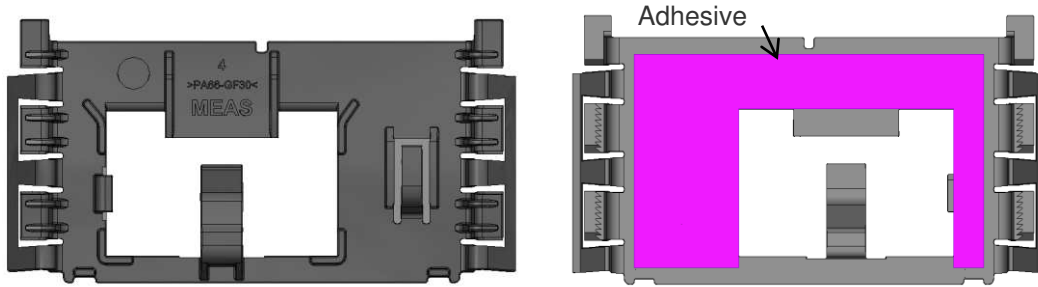

Bracket is specially developed to ensure insertion of sensor in the right way (Poka Yoke ribs), contact of temperature sensor with the windscreen, and maintain of system by adhesive.

1.3. Cover

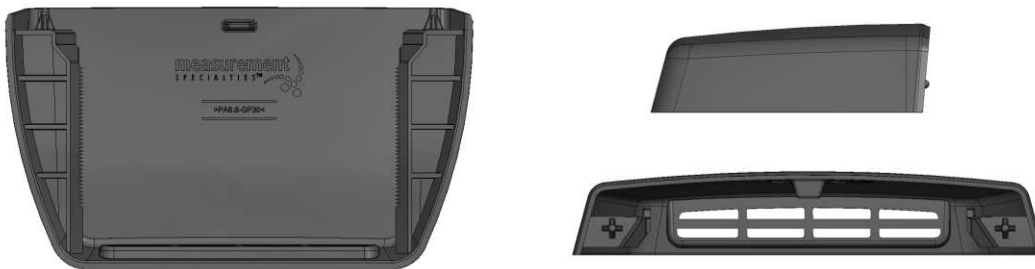

Cover is developed with specific interface to ensure maintain on the Bracket, and air flow circulation on the sensor. *Cover shape could be designed by Customer.*

2. GENERAL MOUNTING RECOMMENDATIONS

Fogging prevention sensor must be placed on windshield.
Placed above the visible area of the windscreen is one of recommended location.

Following points are only basis recommendations and must be confirmed on final system.

- Glass surface must be clean, dry and without dust and particles before bracket application.
- Windscreen Temperature Sensor (WTS) must be in direct thermal contact to the windshield glass

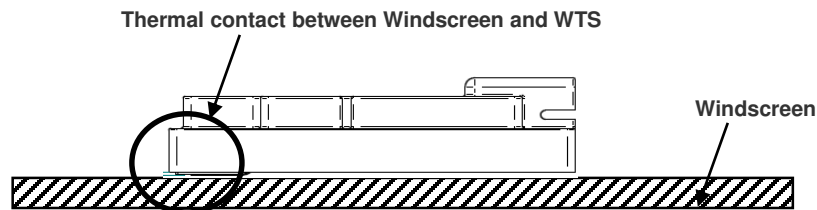

- Do not place close to warm parts (eg: light bulb / windscreen heater).
- The sensor is designed for a minimum windshield curvature radius of 1033mm.

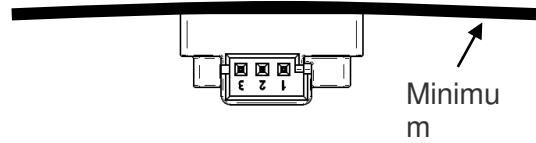

- Sufficient air circulation ventilation should be allowed to flow through the ventilation slits and on the sensor opening by managing space* between windshield and openings* on cover.
- **Exact dimensions have to be defined depending on car model.*
- Placement of sensor on windscreen.

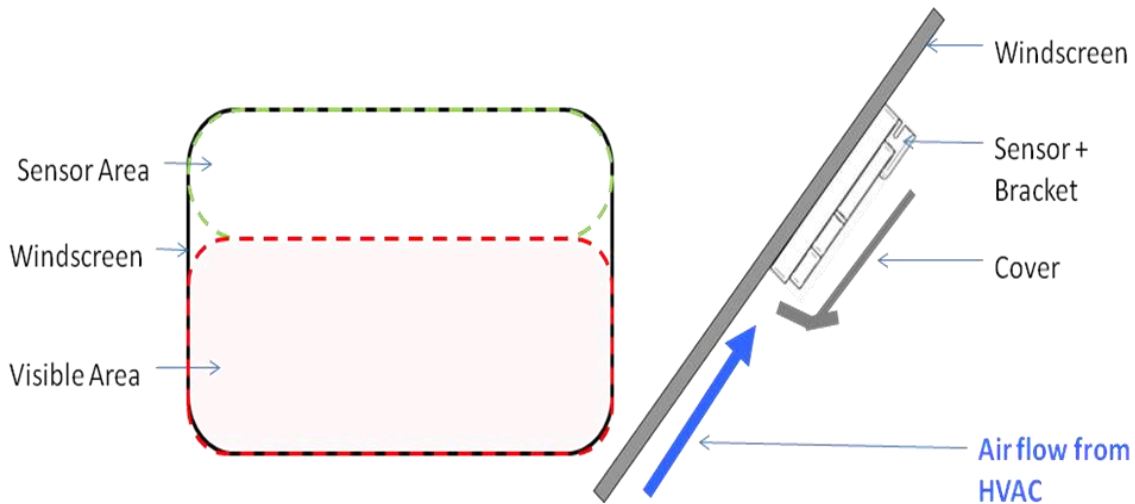

3. BRACKET MOUNTING AREA ON WINDSCREEN RECOMMENDATIONS

Windscreen surface must be without serigraphy and totally cleaned (fingerprint/ grease or any dirtiness) before sensor mounting.

3.1. Bracket glued on windscreen

MEAS recommends adhesive tape 3M VHB 5925 for this application.

3.2. Storage conditions before assembly on Windscreen

The tape has a shelf life of 24 months from date of manufacture when stored at 5°C to 35°C and 0 to 90%RH. The optimum Storage conditions are 22°C and 50%RH.

3.3. Assembly conditions (Temperature, pressure, time of pressure and cleaning)

Good surface contact can be attained by applying approximately 100kPa pressure during 3s. Ideal application temperature range is 21°C to 38°C.

To obtain good performance, it's important to ensure that the surfaces are dry and free of condensed moisture.

Most substrates are best prepared by cleaning with a 50:50 mixture of isopropyl alcohol and water prior to applying the tape.

3.4. Conditions impacts after assembly

After application, the bond strength will increase as the adhesive flows onto the surface. At room temperature (22°C), 50% of ultimate bond strength will be achieved after 30 minutes, 90% after 24 hours and 100% after 72 hours.

This flow is faster at higher temperatures and slower at lower temperatures (see figure below).

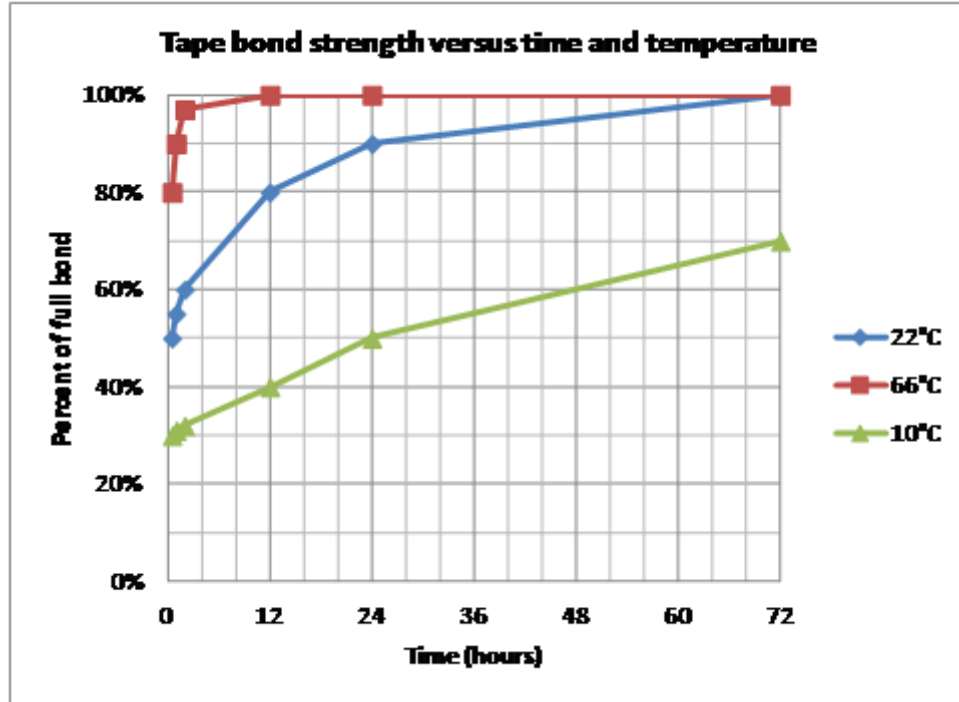

4. ASSEMBLY/DISASSEMBLY RECOMMENDATION

4.1. Sensor connection

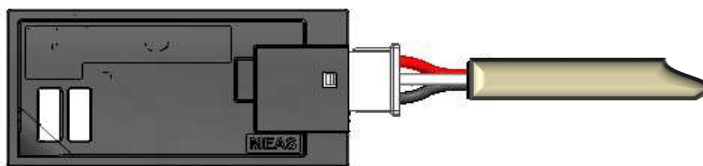

4.2. Sensor insertion inside the bracket

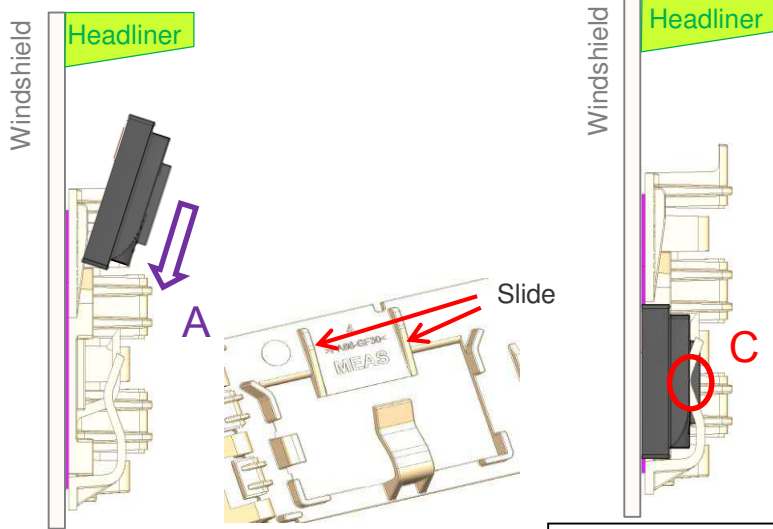

Priming insertion: apply against the slides to control the displacement following "A".

The "C" clip ensures contact between the sensor and the windshield

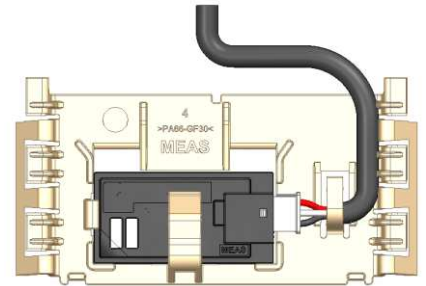

At the end of the displacement sensor is locked in all directions.

4.3. Cover assembly

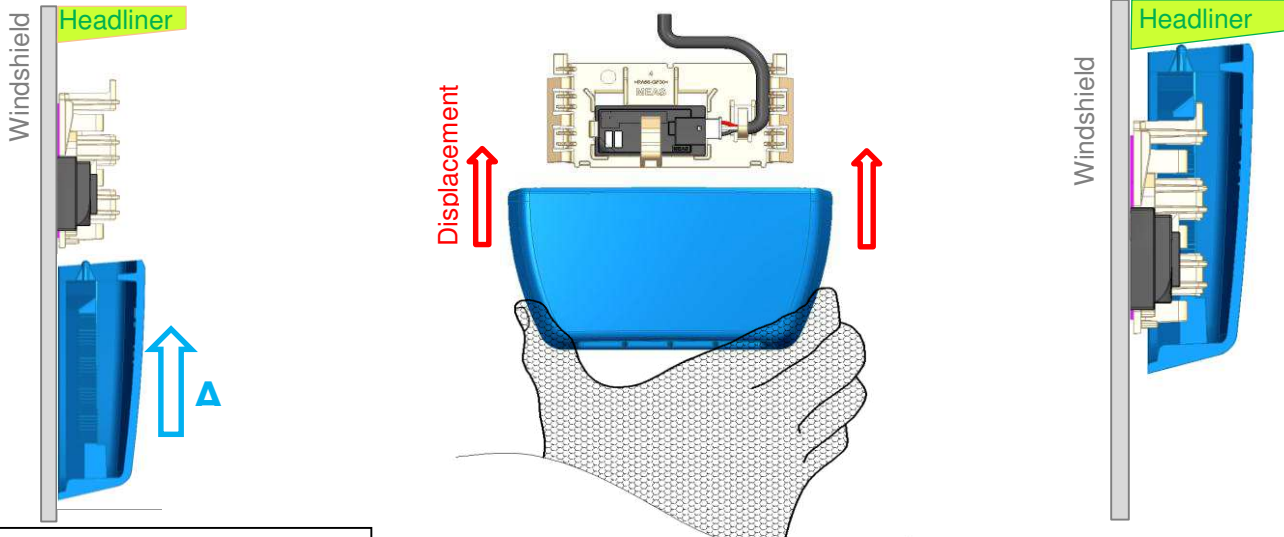

The cover is applied against the windshield and slides along the axis "A".

Recommended handling areas during the insertion

Movements are blocked in all directions.

4.4. **Cover Disassembly**

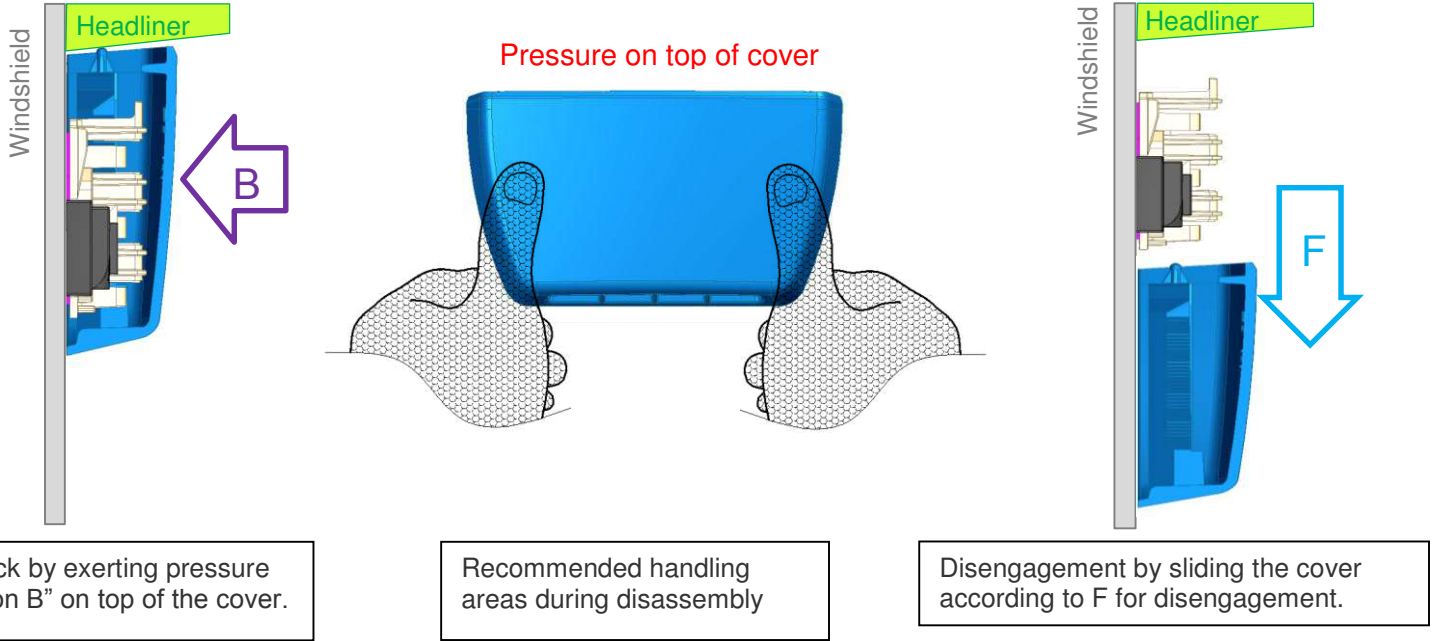

System is designed to support 5 Assembly/Disassembly of cover.

5. **SUPPLIER CHECK OF INSTALLATION – PRODUCT APPLICATION ACCEPTANCE**

In order to deliver the Product Application Acceptance document for the project, before installing this sensor in application, MEAS-SPEC needs to:
 Validate Windscreen temperature/dew point temperature measurement with customer through a mission profile reviews.

- Validate the fogging detection function during fogging appearance and disappearance (in simulator / Vehicle test).
- Review vibration / temperature / heat / RH level on worst case conditions.
- Review windscreen mounting location and procedure for each model.

COVER AND BRACKET DESIGN RECOMMENDATIONS

- Sensor membrane distance from inlet : recommendation : $D < 15\text{mm}$
- Inlet area configuration : recommendation Ratio = 2:1
- Inlet area configuration : recommendation opening area $S > 180\text{mm}^2$
- Sensor top to cover height : recommendation $H > 10\text{mm}$
- Cover edge to windscreen distance : recommendation $E > 1.5\text{mm}$
- Recommendation distance $A = 6 \pm 2\text{mm}$
- Recommendation distance $B > 6\text{mm}$

H2TD3680

Digital RH/T module

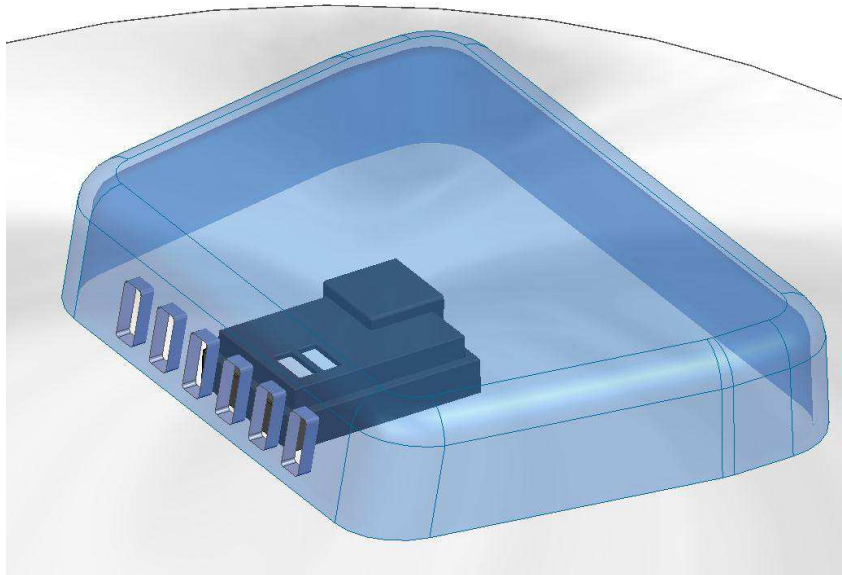
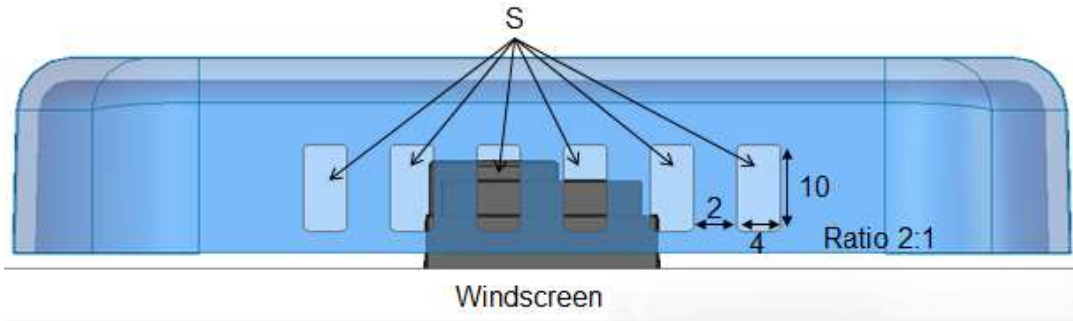
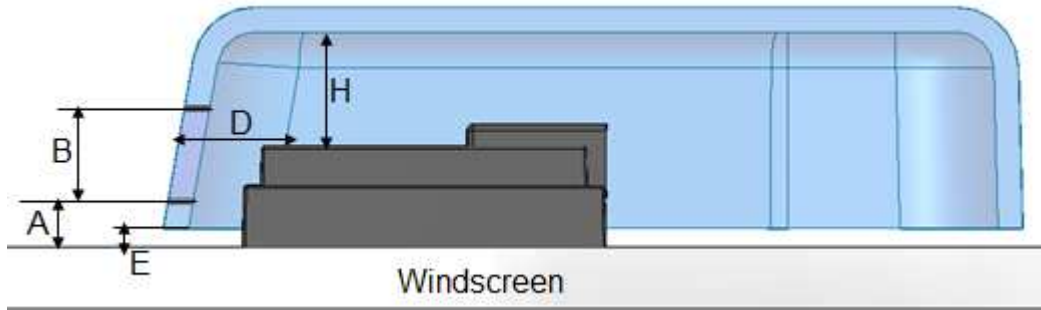

ORDERING INFORMATION

- **HPP827D001 : H2TD3680 - DIGITAL TEMPERATURE AND RELATIVE HUMIDITY MODULE**
- **HPP151-00067: H2TD3680 – Bracket**
- **Cover : Will be discussed with customer**

EUROPE

Measurement Specialties, Inc - MEAS France
Impasse Jeanne Benozzi
CS 83 163
31027 Toulouse Cedex 3
FRANCE
Tél: +33 (0)5 820 822 02
Fax: +33(0)5 820 821 51
Sales: humidity.sales@meas-spec.com

TE.com/sensorsolutions

Measurement Specialties, Inc., a TE Connectivity company.

Measurement Specialties, TE Connectivity, TE Connectivity (logo) and EVERY CONNECTION COUNTS are trademarks. All other logos, products and/or company names referred to herein might be trademarks of their respective owners.

The information given herein, including drawings, illustrations and schematics which are intended for illustration purposes only, is believed to be reliable. However, TE Connectivity makes no warranties as to its accuracy or completeness and disclaims any liability in connection with its use. TE Connectivity's obligations shall only be as set forth in TE Connectivity's Standard Terms and Conditions of Sale for this product and in no case will TE Connectivity be liable for any incidental, indirect or consequential damages arising out of the sale, resale, use or misuse of the product. Users of TE Connectivity products should make their own evaluation to determine the suitability of each such product for the specific application.

© 2015 TE Connectivity Ltd. family of companies All Rights Reserved.

Mouser Electronics

Authorized Distributor

Click to View Pricing, Inventory, Delivery & Lifecycle Information:

[TE Connectivity:](#)

[HPP827D001](#)