



APPLICATORS

PREMIUM QUALITY MANUFACTURING
OF CRIMP CONNECTIONS



PREMIUM QUALITY MANUFACTURING OF CRIMP CONNECTIONS

Selecting the Applicator for Your Requirements

SELECTION GUIDE

 Flexibility

 Value

 Pneumatic Power

 Cycle Counts

 Safety

OCEAN Applicator 2.0 - Mechanical



- Wire range: 0.13 - 10.0 mm²
- Applicable for 90% of standard terminals
- Available in Atlantic (w/male adapter) and Pacific (w/ female adapter) style formats to handle multiple press styles
- Designed to handle the smallest terminals
- Robust crimp height adjustment ring
- Optimized crimper and anvil geometry



OCEAN Applicator 2.0 - Pneumatic

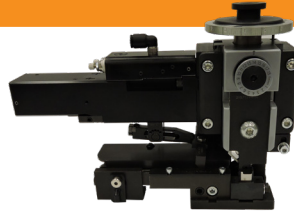

- Wire range: 0.13 - 10.0 mm²
- Compact air feed design for easier fit into most bench presses
- Applicable for 90% of standard terminals
- Available in Atlantic (w/male adapter) and Pacific (w/ female adapter) style formats to handle multiple press styles
- Designed to handle the smallest terminals
- Robust crimp height adjustment ring
- Optimized crimper and anvil geometry
- Intuitive adjustments on the airfeed



Large Wire



- Wire range: 25.0 - 50.0 mm²
- Fine adjustment
- Press stroke: 40.0 mm
- Shut height: 135.78 mm



Splice



- Wire range: 0.5 - 25 mm²
- Fine adjustment
- Press stroke: 40.0 mm
- Shut height: 135.78 mm
- Side feed splice terminals up to 45.0 mm



Mid Size

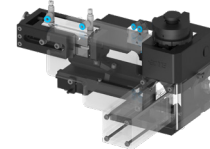

- Wire range: > 10.0 - 25.0 mm²
- Can fit on presses that accept traditional applicators
- Robust casting frames

Center Line & Applicator Alignment Gauges



- Ideal instrument to assure correct positioning of all TE applicators
- Compatible with TE & commercially available crimping presses, using quick changes style applicators



CrimpData App



- Provides compatibility verification between terminals and tooling
- Scans and looks up applicator and terminal information
- Enables you to record cycles on the applicator spare parts
- Scan this QR code to download from the APP store



Collars



- Designed to protect applicators from unwanted motion and damage during transport
- Available in three colors to help differentiate between active and inactive applicators

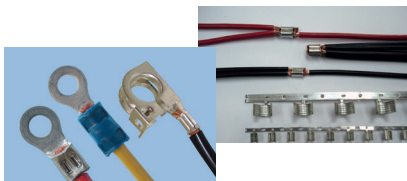

OCEAN 2.0 Applicator Facts and Features



Spare Tooling: Chrome plating, specialized materials, precision tolerances, and mirrored surface finishes yield up to a 30 % customer reported increase in tooling life



DID YOU KNOW...

- Most lead makers are only producing leads 60 % of the time
- Applicators are a decisive criterion for machine efficiency
- Terminal feeding issues are the most common adjustment
- OCEAN applicators provide
 - 60 % improved ram/housing alignment
 - 50 % faster set-up and adjustment times
 - 30 % customer reported tooling life increase

Easy, predictable and precise adjustments

PREMIUM QUALITY MANUFACTURING OF CRIMP CONNECTIONS

Choosing an Applicator

OCEAN 2.0 Applicator Series

With the knowledge and experience of over a half century designing and manufacturing applicators and tooling, TE Connectivity (TE) has taken terminal crimping to a new level. Using the proven OCEAN applicator platform as a base, TE has developed the latest wave in applicator technology...the OCEAN 2.0 Applicator. TE has listened to customer input and market demands to innovate and improve the popular OCEAN applicator to be more robust, faster to install/adjust and even more accurate.

The lead and harness industry of today is more price and quality competitive than ever before. Crimping standards continue to be raised to higher levels of quality and repeatability. The industry continues to expect more from application tooling.

The new OCEAN 2.0 applicator series was designed specifically to exceed the requirements of today and meet the demands of tomorrow.

By consolidating our applicator offering to this latest OCEAN 2.0 applicator platform, TE can provide design consistency and tooling standardization to the market. One of the major benefits to the customer is offering the ultimate in flexibility with a choice of feeding options; new and improved mechanical and pneumatic feed options.

One Applicator Platform - Modular Family Design

- 2 feed options - Mechanical & Pneumatic
- Same feed units can be used on Side-Feed and End-Feed style applicators
- All units can be easily removed and interchanged for upgrades if desired
- 2 ram interface styles ("Atlantic" or "Pacific" style)
- Same wire crimper, insulation crimper, and anvil used on both applicator styles

Atlantic-Style



Mechanical Feed



Pneumatic Feed

Pacific-Style



Mechanical Feed

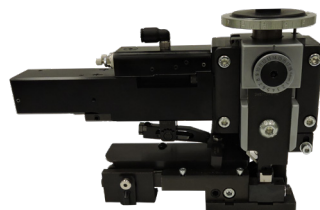

Pneumatic Feed



Choosing an Applicator

Standard Features on all OCEAN 2.0 Applicators

One of the major design goals of the OCEAN 2.0 applicator series was increased flexibility. By giving the applicator the ability to flex between different terminator configurations it allows customers to quickly adapt their applicators to whatever configuration is needed. All parts to reconfigure the applicator are included and attachable to the unit for safe storage and quick access.

As standard equipment the latest applicator will have all the accessories needed to switch between 30 and 40 mm stroke terminators, pre-feed and post-feed cam configurations and cut and no-cut carrier options. The wire stop / wire stripper can also be easily adjusted for the desired application, and a mechanical counter is included for tracking cycle counts.

The applicator comes with all parts needed to configure it to any terminating method that is acceptable to the application.

- Pre-feed and post-feed cams
- Cut and no-cut carrier options
- Adjustable terminal stripper
- Adjustable spring-loaded terminal hold down
- Mechanical counter
- Fine adjust crimp height mechanisms



OCEAN Applicator Part Number System

Because so many features have been added to the applicator the part numbering system used to identify the applicators can be simplified significantly. Now, when ordering an applicator the customer will only need to identify what style and feed type they require.

OCEAN Applicator Style	Description	Part Number Scheme
Atlantic Style	Mechanical Feed	xxxxxxx-1
	Air Feed	xxxxxxx-2
	Atlantic Air Feed with sensors & no valve assembly	3-xxxxxxx-2
	Atlantic Mechanical feed for Bench Strip-seal terminators	5-xxxxxxx-1
	Atlantic Air feed for Bench Strip-seal terminators	5-xxxxxxx-2
	Atlantic Mechanical feed (-1) with spare part kit (7-7)	7-xxxxxxx-1 & 7-xxxxxxx-7
	Atlantic Air feed (-2) with spare part kit (7-7)	7-xxxxxxx-2 & 7-xxxxxxx-7
	Spare Parts Kit	7-xxxxxxx-7
Pacific Style	Mechanical Feed	2-xxxxxxx-1
	Air Feed	2-xxxxxxx-2
	Spare Parts Kit	7-xxxxxxx-7

* Non-crimp height adjust applicator is designed to run in a terminator with system iii crimp height adjust technology.

*** Part number example.

Spare Part Kits have been designed to be used on all styles of OCEAN applicators with pneumatic feed.

PREMIUM QUALITY MANUFACTURING OF CRIMP CONNECTIONS

OCEAN Applicator Facts and Features

Two Terminal Feed Options

Mechanical Feed

The cam/follower design produces repeatable feed in the industry. Independent forward/backward adjustment.



Standard Features

- Significantly improved repeatability
- Same feed module for side feed and end feed
- Single tool adjustments
- Infinite micro feed adjustment increments 1 revolution = 0.7 mm

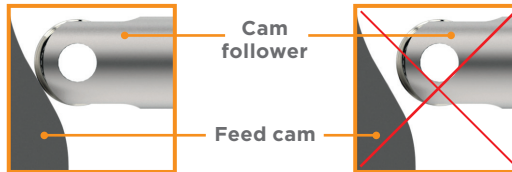

This design gradually starts the terminal into the feeding process.

Advantages

- Precise and repeatable terminal position over the anvil
- Independent forward and back stroke adjustment
- 50% faster adjustments compared to HDI/HDM

Pneumatic Feed

Independent forward/backward adjustments, independent flow controls, repeatable feed.

Standard Features

- Single tool or tool-less adjustments
- Same feed module for side feed and end feed
- Independent forward & back adjustments
- Micro feed adjusted incrementally with steps 0.04 mm forward terminal position
- Maximum feed length: 48.25 mm

Advantages

- Independent forward and back stroke adjustment
- Adjustable speed actuation
- Self actuating
- Single or tool-less adjustment
- Single piece piston and rod assembly
- Internal exhaust valves

Smaller air feed design on the OCEAN 2.0 Applicator fits into more terminators

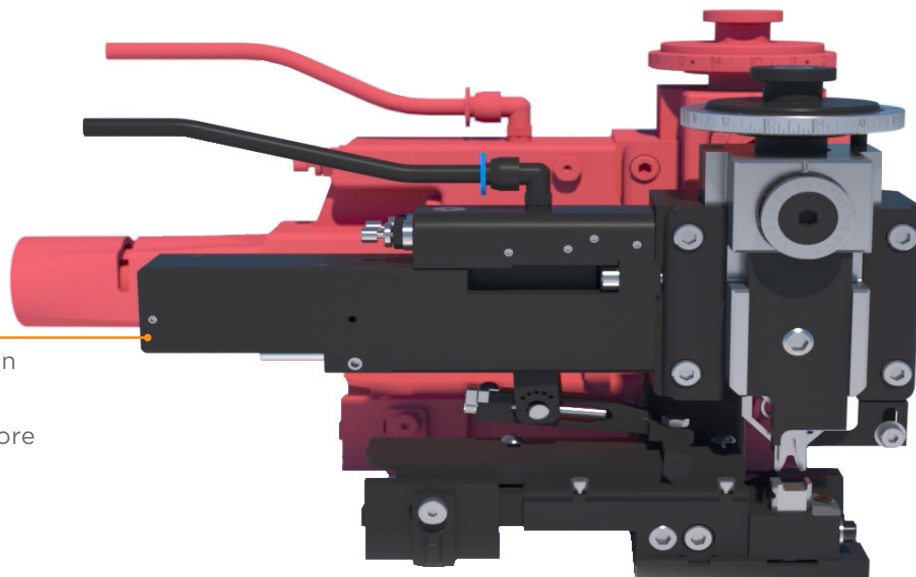

OCEAN 2.0 Applicator - Redesigned from the Bottom Up

The OCEAN 2.0 applicator series includes several new features to aid in reliability and repeatable performance. To help prevent misalignment and during installation, the OCEAN 2.0 design includes a pinned baseplate.

Standardization of adjustment and mounting screws reduces the number of tools needed to install and/or adjust an applicator. The OCEAN 2.0 line has been designed to reduce the number of unique tools needed to service, thereby shortening downtime and improving upon TE's already impressive quick install rate.

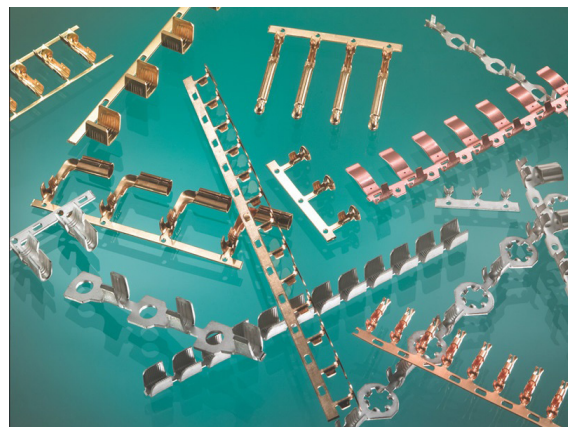
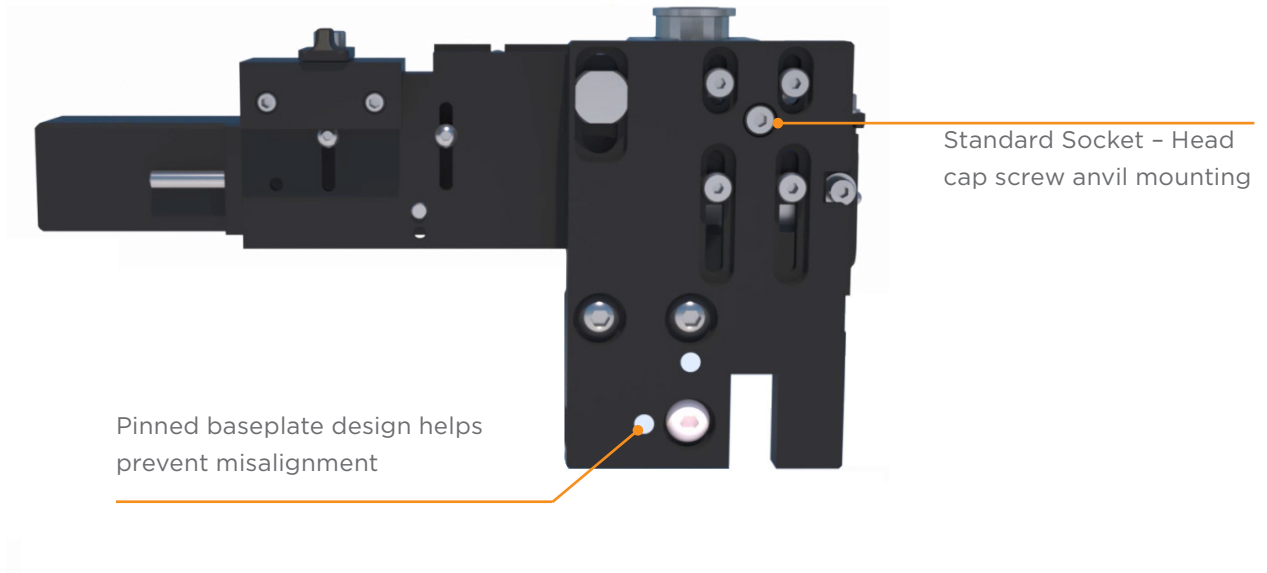

PREMIUM QUALITY MANUFACTURING OF CRIMP CONNECTIONS

OCEAN 2.0 Applicator – Small Wire Crimping 0.22 mm² / 24 AWG

Applicators for small wire sizes

Today’s miniaturized terminals demand a high quality applicator in order to meet the requirements of crimp specifications with very small tolerances. The TE OCEAN 2.0 applicator, with its improved ram alignment, fine adjust crimp height control and other enhancements is well suited to meet these requirements. We have even more features for those applications running small wire sizes (terminals for wire sizes below 0.35 mm² (22 AWG). These features focus on the location control of the crimper and anvil along the axis of the terminal wire barrel.

We were able to better control this location by changing the method in which we mount the anvil to the base plate in the applicator. This increased control allows the crimped terminal to more consistently meet

the specification requirements for bell-mouth and cutoff tabs, which are commonly controlled with very small tolerances.

Miniaturization of the connectors places higher demands on the processing machines.

Especially the crimp applicator has to fulfill high requirements:

- High mechanical precision
- Repetition accuracy of the terminal feeding system
- Low friction of the ram

Wire Size 0,13 mm² with miniaturized terminal



OCEAN applicator for small terminal is designed to improve the repeatability of the anvil location relative to the ram. This is accomplished by tighter tolerances on several components, special anvil, modified base-plate and a customize shoulder screw to accurately locate the anvil. All other components (including ram and housing) are normal ocean parts.

Terminal hold-down designed specific to terminal body

Insulation crimp adjustment increments to match that of reduced cable insulation range

Pneumatic feed

Touch Tooling:

- Crimper and ram reduced clearance (closer fitting)
- No crimper spacer minimize tooling stack tolerance build-up
- Shear depressor mount on underside of ram (constant remount height)

Terminal strip guide assembly requiring 75 % less set-up and adjustment

Terminal strip guide assembly:

- Closer fitting relative to applicator base plate
- Finer bell-mouth / cut-off tab adjustment
- Increased strip guide assembly to applicator base plate engagement
- Reduced clearance between terminal stock thickness and guide plate
- Frontal bell-mouth lock and adjustment

Closer fitting terminal drag

Anvil:

- Location by close tolerance shoulder screw
- Reducing need to adjust terminal strip guide
- Repeat position

OCEAN Applicator – LITEALUM Wire Crimping

Executive summary

- In parallel with LITEALUM terminal development, TE application tooling has been developing crimp tooling
- Primary goal: Keep the crimping process the same for crimping aluminum. TE is a terminal manufacturer with this goal, giving to our customers a major competitive advantage

- We have developed a series of applicators that crimp all of the terminals released to date
- We have met a number of challenges and have solutions to each
- We continue to work on future improvements

Unique applicator features of LITEALUM wire crimping

- Wire crimper with 3-d blend
- Anvil (slightly different has tapered angle)
- Wire depressor (uses special spring-loaded depressor)
- Housing (has cut to mount left side style stripper)
- Modified drag to reduce lateral movement
- Fine adjust insulation adjuster

Tooling - crimper & anvil

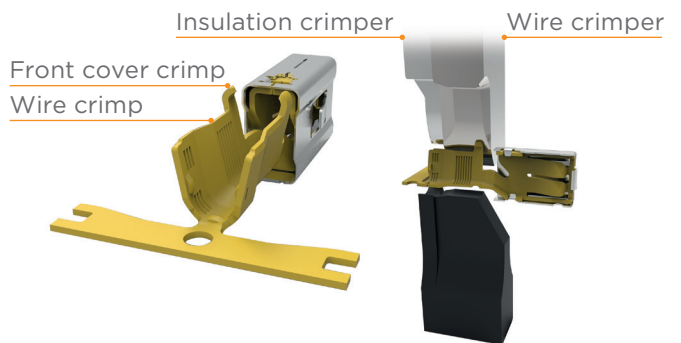

Value for the customer

OCEAN applicator design, global standard

OCEAN applicator for MQS terminals

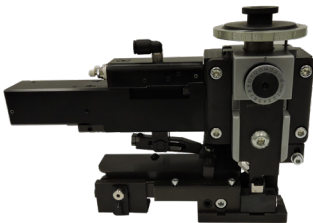

OCEAN applicator for LITEALUM terminals

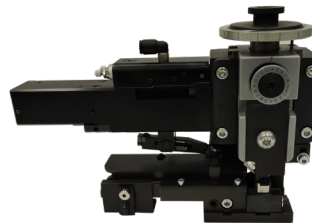

Special wire crimp profile

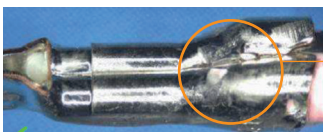

3 dimension blend

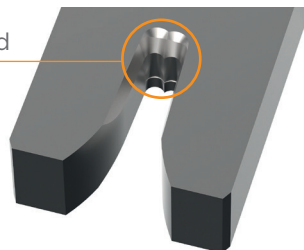

PREMIUM QUALITY MANUFACTURING OF CRIMP CONNECTIONS

TE CrimpData App

Our OCEAN applicator offering just got a whole lot more flexible thanks to TE CrimpData. With this mobile app you can manage applicator and spare parts inventory, and quickly verify that you have the right applicator for your terminal without having to run back to your desk. And it's completely free to download from your smart phone or tablet's app store!

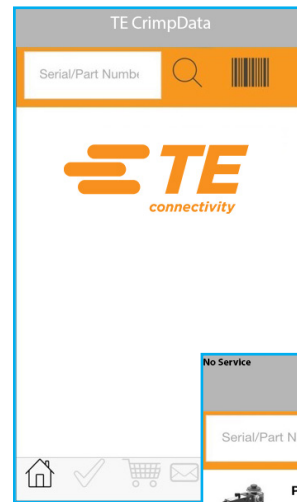

- Get part numbers of spare parts
- Set individual cycle count of spare parts
- Coming soon (order spare parts)



What can it do?

- Reads the new data matrix bar-code on applicator tags to provide the latest crimp information.
- Provides compatibility verification between terminals and tooling
- Scans and looks up applicator and terminal information
- Enables you to record cycles on the applicator and spare parts



2D data-matrix bar-code ID tag



TE CrimpData App

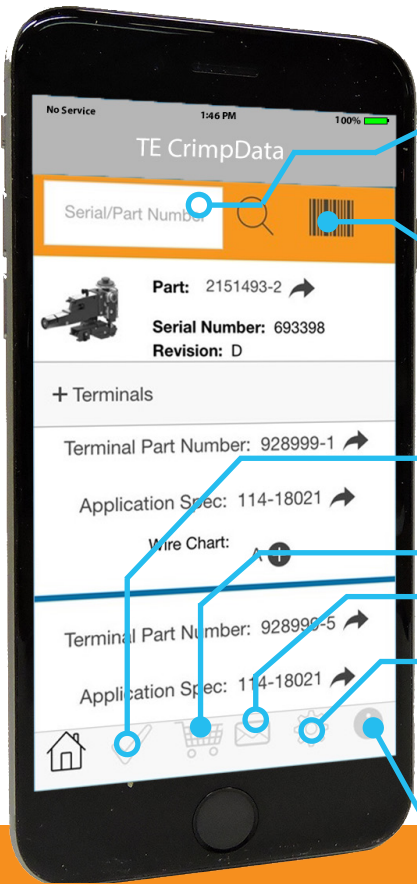

The TE CrimpData app is available on both the iPhone and Android platforms. Search for "TE CrimpData" to locate and download the App.



Manual Search Functionality

Don't have a QR code? No problem. Manually enter the serial or part number and search the database for applicator and terminal specs.

Bar-code Scanner

Click, scan and search with the touch of a button.

The Right Tool for the Job

TE CrimpData can help you quickly cross reference the applicator to your terminal and verify if it's the right match.

Order Parts

Ready to check out? TE CrimpData allows you to find and order compatible spare tooling. (Coming soon)

Sharing Tool

Quickly launch your email to send order details to yourself or someone else.

Stay on Track

Track and edit applicator and individual cycle counts for spare tooling.

Power of the Cloud

TE CrimpData connects to TE.com and provides a wealth of information like wire size charts, and application specifications.

PRODUCT	
	Application Tooling - OCEAN Applicators CRIMPER, WIRE .130 "F" - 456410-4 TE INTERNAL NUMBER: 456410-4 ✓ Active
Not in Scope for EU RoHS/ELV Compliance	
Region Worldwide	
Tool Type Applicator	
Spare Parts Tooling Yes	
Spare Parts Tool Type Crimper	

Manage inventory and stay productive all with the power of the TE CrimpData app.

PREMIUM QUALITY MANUFACTURING OF CRIMP CONNECTIONS

Effective Crimp Performance

Detachable Lubricator Assembly

It is easy to overlook, but routine greasing can be a factor in reducing production downtime. Checking tooling - inspecting crimpers and anvils - before they break also will support production continuity.

Just as with any machinery, lubrication of the applicator reduces wear and even protects against corrosion.

Specific use of contact lubricant on terminals prevents the friction that can lead to sticking in the crimper, bent terminals, and premature crimper wear.

- Assembly for side feed and end feed versions are available
- Simple attachment
- Broad wick and variable adjustments for complete terminal coverage
- Clear composite shell for easy viewing of lubricant levels

Description	Part Number
Side feed assembly	2119955-1
End feed assembly	2119955-2



Transporting Applicators Safely

Although applicators are manufactured to withstand the impact of crimping, crimpers and anvils must not contact each other. Such contact can scrape the plating or the crimping surface, causing a friction point. Friction points can form metal buildup, ultimately causing reject crimps and even tool breakage.

This problem is easily avoided. Always leave a terminal in the crimp tooling when moving the applicator from one location to another. This allows the terminal to receive any possible contact and protects the tooling.

The collar protects the applicator from unwanted motions and damages.

Description	Part Number
Collar orange - standard TE color delivered with the applicator	2119783-1
Collar red - order separately	2119783-2
Collar green - order separately	2119783-3



Effective Crimp Performance

OCEAN applicators are dedicated to providing high quality crimp connections to meet corresponding specifications.

OCEAN applicator gauges ensure the correct applicator alignment to produce high quality crimp connections.

Description	Part Number
OCEAN Applicator Gauge, Side Feed	2161422-2
OCEAN Applicator Gauge, End Feed	2161422-3

Side Feed Applicator with Gauge built in

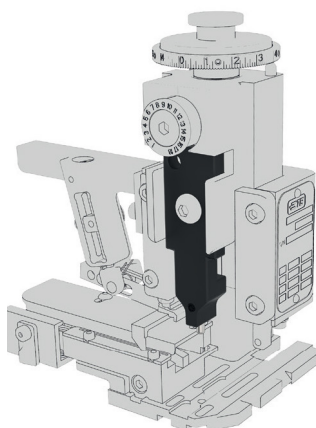

End Feed Applicator with Gauge built in

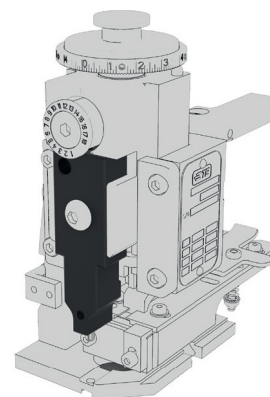

Side Feed Applicator Gauge

End Feed Applicator Gauge

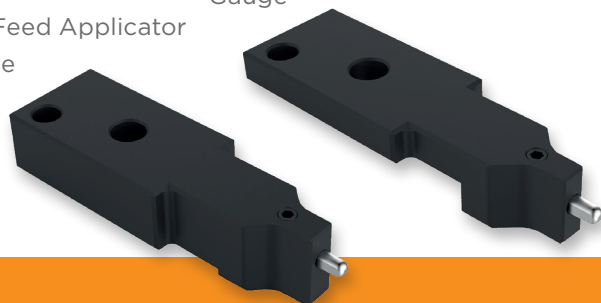

Gauges

Compatible with TE Connectivity and commercially available crimping presses, using quick changes style applicators.

Applicator Gauge

Ideal instrument to assure correct positioning of all TE applicators

- Connectivity applicators
- Simple installation and use

Description	Part Number
Applicator Gauge Kit, Crimp Machines	528440-5



PREMIUM QUALITY MANUFACTURING OF CRIMP CONNECTIONS

Selecting an Applicator Online

A convenient lookup function on the TE website will guide you through applicator selection and provide access to all necessary documents and drawings.

If you do not find an applicator to meet your requirements, please refer to www.te.com/support-center

www.te.com/usa-en/products/application-tooling/mini-applicator-parts-search.html

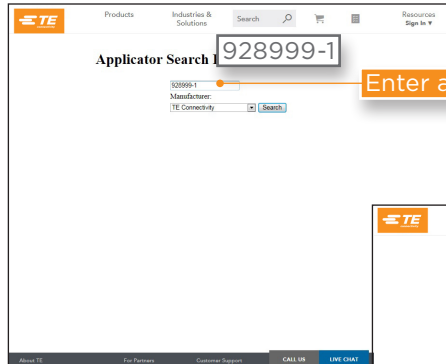

Enter a terminal PN.

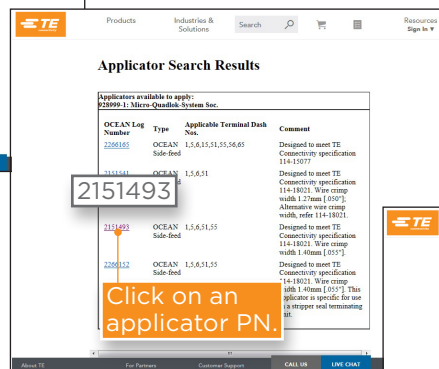

Click on an applicator PN.

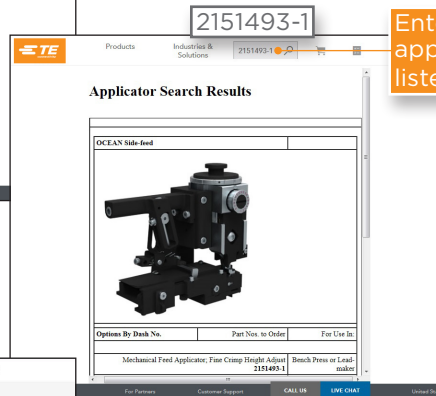

Enter a complete applicator PN as listed below.

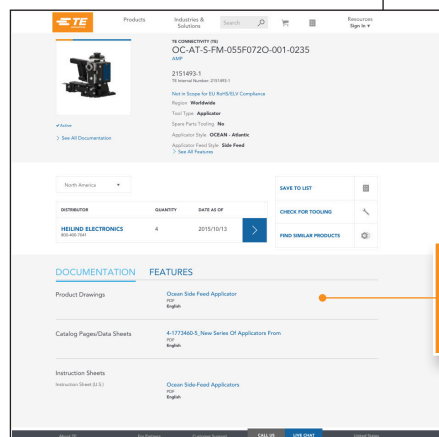

Click on a pdf and open customer drawing with crimp data or further documentation.

Selecting Replaceable Tooling Online

Only by the use of genuine TE Connectivity tooling can you be assured of a long-lasting tool life and very reliable production. The design, materials, and manufacturing quality of TE tooling translate directly into fewer rejects, fewer breakdowns and interruptions.

To determine the tooling part number for a specific applicator, simply set your web browser to

www.te.com/global-en/products/application-tooling/applicator-spare-parts-search.html

Enter the applicator part number, and click on Search Parts. The part numbers of replaceable tooling will be displayed.

The same lookup allows you to enter the part number of a crimper and find out what applicators is suitable for it.

1 Enter an applicator PN without dash numbers.

A list of all applicator PNs where the spare part used will be shown.

2 Select a spare part PN and return to the previous screen.

3 Enter your spare part PN and click on the button Search Parts.

4 A complete applicator overview using this PN is shown.

www.te.com/commerce/DocumentDelivery/DDEController

Enter a TE part number and click on the search button.

A list with documents and drawings relating to this PN is shown.

Enter a document number and click on the search button.

The relevant document is shown.



Let's Connect

To learn more about the right TE tooling for your needs, visit tooling.te.com

TE Technical Support Center

USA:	1.800.522.6752	UK:	+44.0800.267666
Canada:	1.800.522.6752	France:	+33.1.34.20.8686
Mexico:	+52.55.11.06.0800	Netherlands:	+31.73.624.6999
Latin/S. America	+54.11.4733.2200	China:	+86.400.820.6015
Germany:	+49.6151.607.1999		

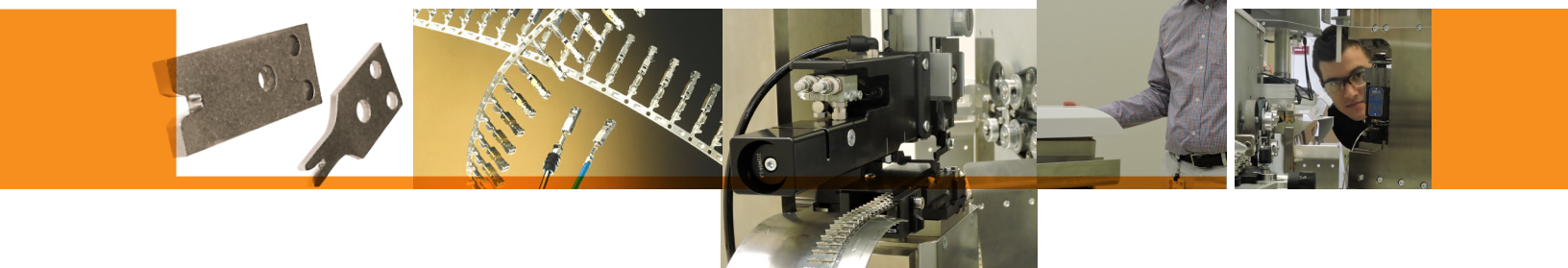
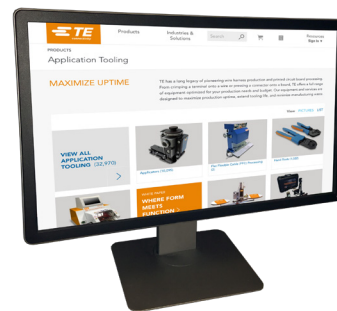

tooling.te.com

© 2019 TE Connectivity Ltd. family of companies. All Rights Reserved.
 AMP, EYE Check, LITEALUM, OCEAN, RAYCHEM, SOLARLOK, TE Connectivity and TE connectivity (logo) are trademarks.
 Crimpmatic is a trademark. MOST is a trademark.
 Other product and/or crimping names herein might be trademarks of their respective owners.
 1-1773864-9 4-19 Rev B

Contact us today to learn more

E-mail (Americas): fieldservicesnorthamerica@te.com

Phone (Americas): 800-722-1111 or 717-986-3434

E-mail (EMEA): TEFE1@te.com

Phone (EMEA): +49-6151-607-1518

For additional information download catalog from tooling.te.com.

www.te.com

Mouser Electronics

Authorized Distributor

Click to View Pricing, Inventory, Delivery & Lifecycle Information:

[TE Connectivity:](#)

[2-2151162-2](#)