

# APPLICATORS

PREMIUM QUALITY MANUFACTURING  
OF CRIMP CONNECTIONS

# PREMIUM QUALITY MANUFACTURING OF CRIMP CONNECTIONS

## Selecting the Applicator for Your Requirements

---

### Platform

#### OCEAN Applicator Series for Strip Form Terminals



### Product Features

- Applicable for 90 % of standard terminals
- Wire range: 0.13 – 10.0 mm<sup>2</sup>
- Available with retrofittable feed mechanism for mechanic feed, pneumatic feed or servo feed
- New technologies:
  - Aluminum
  - Small wire application

---

#### HD-M Applicator for Strip Form Terminals



- Applicable for non standard terminals
- Wire range: 0.20 – 10.0 mm<sup>2</sup>
- Fit TE terminator-style presses
- Fine adjustment pneumatic feed available
- Press stroke: 40.0 and 30.0 mm (cam change, as OCEAN applicator)
- Shut height: 135.8 mm
- Applicator feed:
  - Side feed terminal 26.5 mm (1.043 in)
  - End feed terminal up to 34.5 mm (1.358 in)

---

#### Mini Applicator for Strip Form Terminals

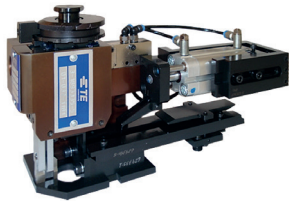

- Wire range: 0.14 – 10.0 mm<sup>2</sup>
- Fine adjustment
- Press stroke: 40.0 mm
- Shut height: 135.8 mm
- Applicator feed:
  - Side/end feed terminal up to 45.0 mm
- Applicator drive: pneumatically
- Compatible with Crimpmatic 970 with base plate for conventional TE applicators or similar crimp machine

---

#### Mid Wire Size Applicator for Strip Form Terminals

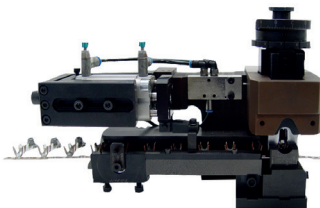

- Wire range: > 10.0 – 25.0 mm<sup>2</sup>
- Can fit on presses that accept traditional applicators
- Robust casting frames
- Accurate pneumatic feeding
- Used on Crimpmatic bench presses for 5 and 15 tons
- Fine adjustment
- Press stroke: 40.0 mm
- Shut height: 135.78 mm
- Applicator feed:
  - Side/end feed terminal up to 55.0 mm
- Applicator drive: pneumatically
- Compatible with Crimpmatic 971 or similar crimp machine

## Selecting the Applicator for Your Requirements

---

### Platform

#### Large Wire Size Applicator for Strip Form Terminals

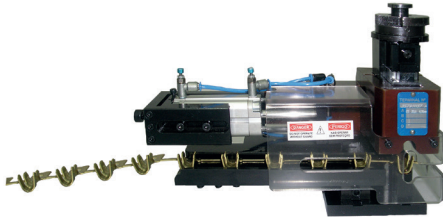

### Product Features

- Wire range: 25.0 – 50.0 mm<sup>2</sup>
- Fine adjustment
- Press stroke: 40.0 mm
- Shut height: 135.78 mm
- Applicator feed:  
Side/end feed terminal up to 55.0 mm
- Applicator drive: pneumatically
- Compatible with Crimpmatic 971 or similar crimp machine

---

#### Applicators for Standard Loose Piece Terminals

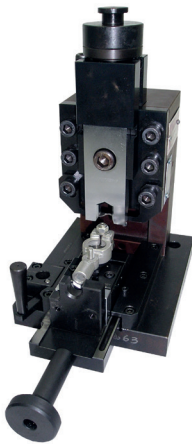

- Wire range:  
Mini applicator: 0.35 – 10.0 mm<sup>2</sup>  
Mid wire size applicator: 10.0 – 25.0 mm<sup>2</sup>  
Large wire size applicator: 25.0 – 50.0 mm<sup>2</sup>
- Standard applicator for wire ranges up to 10.0 mm<sup>2</sup>
- Used on traditional TE bench presses
- Fine adjustment
- Press stroke: 40.0 mm
- Shut height: 135.8 mm
- Movable table with dedicated terminal seat (according to terminal geometry) to load and unload terminals
- Custom designs available for nearly any terminal
- Applicator for wire ranges up to 50.0 mm<sup>2</sup>
- Compatible with Crimpmatic 971 or similar crimp machine
- Press stroke: 44.0 mm
- Shut height: 158.0 mm
- Applicator feed: terminal loading manually

---

#### Mid Wire Size Splice Applicator for Strip Form Splice Terminals

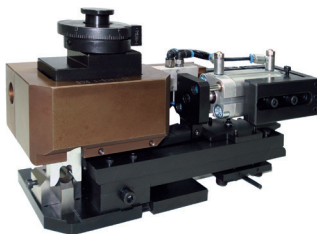

- Wire Range: 0.5 – 25 mm<sup>2</sup>
- Fine adjustment
- Press stroke: 40.0 mm
- Shut height: 135.78 mm
- Applicator feed:  
Side feed splice terminals up to 45.0 mm
- Applicator drive: pneumatically
- Compatible with conventional Bench Presses up to 6.0 mm<sup>2</sup> (with appropriate press guard\*) and Crimpmatic 970 press with base plate for conventional applicators – plus appropriate safety guard\*

\*TE presses are supplied with standard safety guards; customer is responsible for appropriate changes and adjustments according to necessities.

# PREMIUM QUALITY MANUFACTURING OF CRIMP CONNECTIONS

## Choosing an Applicator

### OCEAN Applicator Series

With the knowledge and experience of over a half century designing and manufacturing applicators and tooling, TE Connectivity is taking terminal crimping to a new level. Using the time proven HDM applicator platforms as a base and the innovation and improvements from the system III applicator, TE is taking a large step forward. TE has listened to customer input and market demands to innovate and improve the combined strength of these industry leading designs to create the latest OCEAN applicator.

The lead and harness industry of today is more price and quality competitive than ever before. Crimping standards continue to be raised to higher levels of quality and repeatability. The industry continues to expect more from application tooling.

### One Applicator Platform – Modular Family Design

- 3 feed options – Mechanical – Pneumatic – Servo
- Same feed units can be used on Side-Feed and End-Feed style applicators.  
All units can be easily removed and interchanged for upgrades if desired
- 2 ram interface styles (“Atlantic” or “Pacific” style)
- Same wire crimper, insulation crimper, and anvil used on both applicator styles

The new OCEAN applicator series was designed specifically to exceed the requirements of today and meet the demands of tomorrow.

By consolidating our applicator offering to this latest OCEAN applicator, TE can provide design consistency and tooling standardization to the market. One of the major benefits to the customer is offering the ultimate flexibility with a choice of feeding options; new and improved mechanical and pneumatic feeds combined with the innovative and precise servo feed option. The OCEAN applicator series design makes it possible for customers to perform field upgrades to system III technology. It will provide an upgrade path for terminal intelligence that allows the machine to obtain set-up features as the applicator is upgraded.

### Atlantic-Style



Mechanical Feed

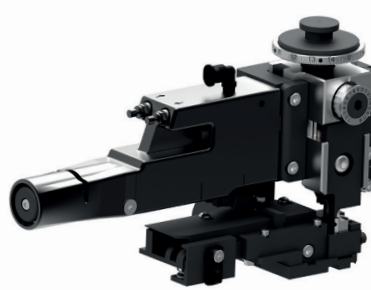

Pneumatic Feed

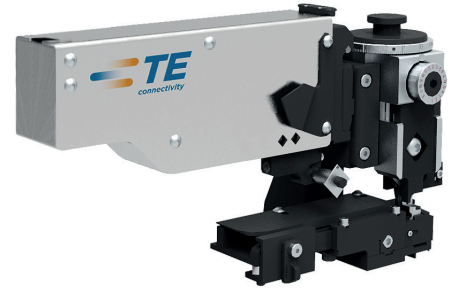

Servo Feed

### Pacific-Style



Mechanical Feed

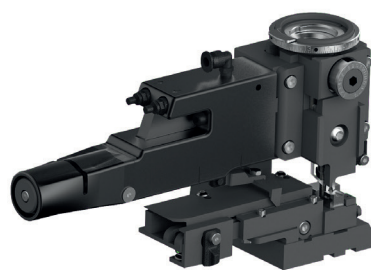

Pneumatic Feed

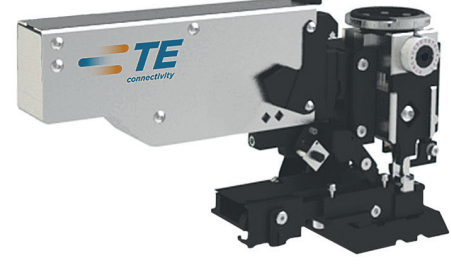

Servo Feed

## Choosing an Applicator

### Standard Features on all OCEAN Applicators

One of the major design goals of the OCEAN applicator series was increased flexibility. By giving the applicator the ability to flex between different terminator configurations it allows customers to quickly adapt their applicators to whatever configuration is needed. All parts to reconfigure the applicator are included and attachable to the unit for safe storage and quick access.

As standard equipment the latest applicator will have all the accessories needed to switch between 30 and 40 mm stroke terminators, pre-feed and post-feed cam configurations and cut and no-cut carrier options. The wire stop / wire stripper can also be easily adjusted for the desired applications, and a mechanical counter is included for tracking cycle counts. The applicator comes with all parts needed to configure it to any terminating method that is acceptable to the application.

- Pre-feed and post-feed cams
- Cut and no-cut carrier options
- Adjustable terminal stripper
- Adjustable spring-loaded terminal hold down
- Mechanical counter
- Fine adjust crimp height mechanisms

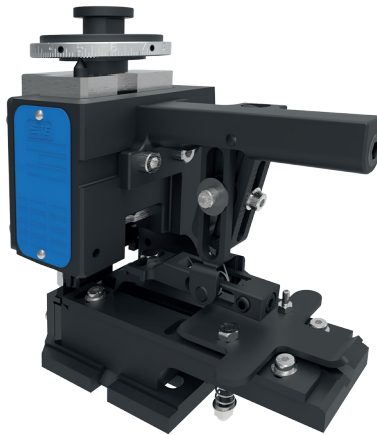

### OCEAN Applicator Part Number System

Because so many features have been added to the applicator the part numbering system used to identify the applicators can be simplified significantly. Now, when ordering an applicator the customer will only need to identify what style and feed type they require.

| OCEAN Applicator Style | Feed Type           | Description               | Part Number       |
|------------------------|---------------------|---------------------------|-------------------|
| Atlantic Style         | Mechanical          | Fine Crimp Height Adjust  | 2151950-1***      |
|                        | Pneumatic           | Fine Crimp Height Adjust  | 2151950-2***      |
|                        | Servo Latch Plate** | Fine Crimp Height Adjust  | 2151950-5***      |
|                        | Servo Latch Plate** | Fine Crimp Height Adjust* | 2151950-6***      |
|                        | None                | Fine Crimp Height Adjust  | 2151950-7***      |
|                        |                     |                           | Crimp Tooling Kit |
| Pacific Style          | Mechanical          | Fine Crimp Height Adjust  | 2-2151950-1       |
|                        | Pneumatic           | Fine Crimp Height Adjust  | 2-2151950-2       |
|                        | Servo Latch Plate** | Fine Crimp Height Adjust  | 2-2151950-5       |
|                        | None                | Fine Crimp Height Adjust  | 2-2151950-7       |
|                        |                     |                           | Crimp Tooling Kit |

\* Non-crimp height adjust applicator is designed to run in a terminator with system level crimp height adjust technology.

\*\* Servo is designed to run a terminator with precision controller.

\*\*\* Part number example.

Spare Part Kits have been designed to be used on all styles of OCEAN applicators with pneumatic feed.

# PREMIUM QUALITY MANUFACTURING OF CRIMP CONNECTIONS

## OCEAN Applicator Facts and Features

---

### Three Terminal Feed Options

#### Mechanical Feed

The cam/follower design produces repeatable feed in the industry. Independent forward/backward adjustment.



#### Standard Features

- Significantly improved repeatability
- Same feed module for side feed and end feed
- Single tool adjustments
- Infinite micro feed adjustment increments 1 revolution = 0.7 mm

#### Advantages

- Precise and repeatable terminal position over the anvil
- Independent forward and back stroke adjustment
- 50 % faster adjustments compared to HDI/HDM

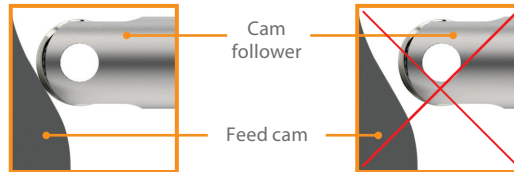

This design gradually starts the terminal into the feeding process.

---

#### Pneumatic Feed

Independent forward/backward adjustments, independent flow controls, repeatable feed.

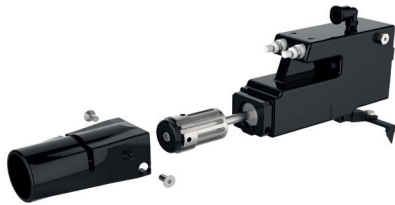

#### Standard Features

- Single tool or tool-less adjustments
- Same feed module for side feed and end feed
- Independent forward & back adjustments
- Micro feed adjusted incrementally with steps 0.04 mm forward terminal position
- Maximum feed length: 48.25 mm

#### Advantages

- Independent forward and back stroke adjustment
  - Adjustable speed actuation
  - Self actuating
  - Single or tool-less adjustment
  - Single piece piston and rod assembly
  - Internal exhaust valves
- 

#### Servo Feed

Machine reads iButton data to adjust stroke and placement positions automatically. Motorized feed allows operator to push a button for precision adjustments.



#### Standard Features

- Can be used with AMPOMATOR system III, smart leadmaker or a precision controller unit
- Motorized feeding action allows for electronic control, adjustment and easy maintenance
- Slow, controlled & accurate terminal placement repeatability
- Product can be moving into position while the terminator is not moving
- Reduces feeding variation caused by different terminal size and weight
- Includes 2 feed fingers that are compatible with 95% of TE terminals

#### Advantages

- Good choice for precise, repeatable feeding results
- Data module stores the personality of the applicator, its identity, and the terminals it can crimp along with crimping parameters
- Push button feed adjustment

iButton is a trademark of Maxim Integrated Products.

---

## OCEAN Applicator Facts and Features

Fine adjust wire crimp height with range of 1.5 mm in increments of 0.01 mm

60 % improvement in ram/housing fit minimizes "system noise" for improved crimp quality monitoring

Integrated data chip stores set-up and maintenance information

Precision machined strip guide customized for each terminal application

Spring loaded terminal drag designed for easy loading/unloading

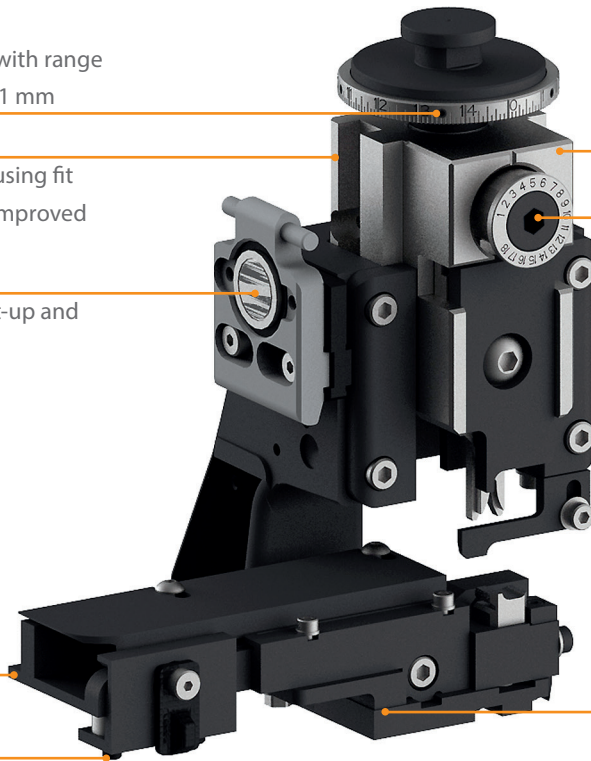

Chrome plated ram for improved lubricity, corrosion resistance, and wear

Large insulation crimp height adjustment range

Adjustable strip guide for precise placement  
Crimp Features  
– bell-mouth  
– cut-off  
– bend up / doon

Spare Tooling: Chrome plating, specialized materials, precision tolerances, and mirrored surface finishes yield up to a 30 % customer reported increase in tooling life



### DID YOU KNOW...

- Most lead makers are only producing leads 60 % of the time
- Applicators are a decisive criterion for machine efficiency
- Terminal feeding issues are the most common adjustment
- OCEAN applicators provide
  - 60 % improved ram/housing alignment
  - 50 % faster set-up and adjustment times
  - 30 % customer reported tooling life increase

Easy, predictable and precise adjustments

# PREMIUM QUALITY MANUFACTURING OF CRIMP CONNECTIONS

## Smart Applicator in any OCEAN Applicator Feed Style

The smart applicator offers the ability to exchange OCEAN applicator information with a lead maker. An integrated data chip stores and relays set-up and maintenance information. The smart applicator data can be viewed and utilized on a lead making machine. This full integration provides the ability to verify the following information related to the terminal:

- Easy and safe programming
- Verification of lead maker settings with smart applicator data
- No manual typing of terminal name is needed for software set-up
- Errors through manual data input are minimized
- Reduction of applicator set-up times
- Self adjustment
- Better crimp quality, especially in difficult and small terminal applications
- Increase in productivity

### Applicator Maintenance

- The integrated cycle counter offers the possibility to set maintenance intervals to maintain the applicator or to exchange wearable parts
- All OCEAN applicator wearable tooling PNs are stored in the data chip and visible on the lead maker screen if needed

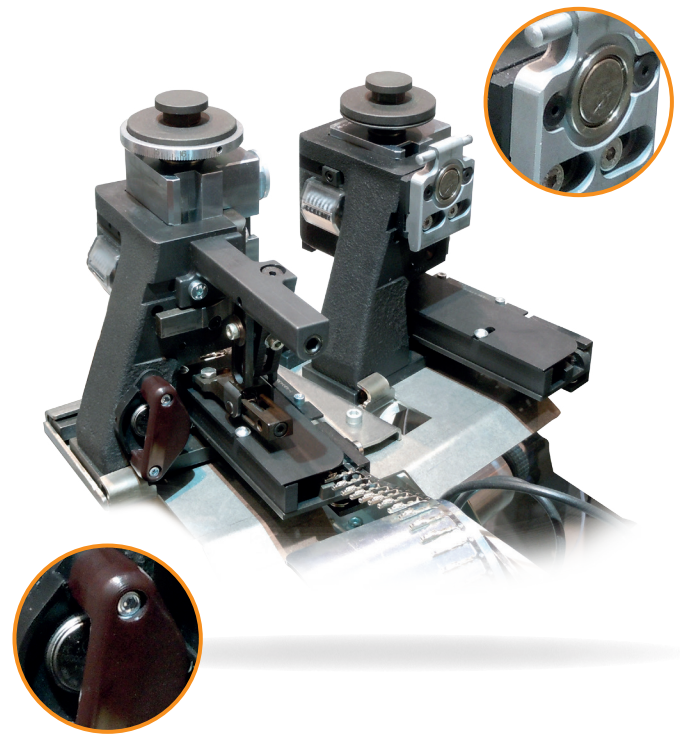

### Data Management Software (DMS)

The software is used on a personal computer to read and analyze the smart applicator data either offline or away from the lead making machine.

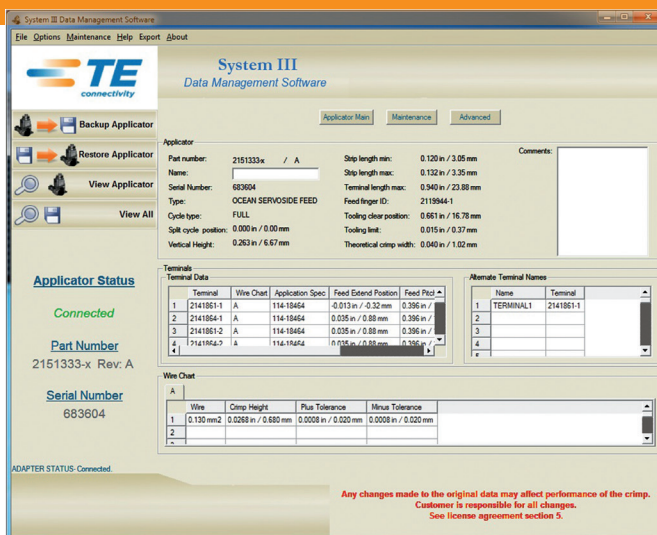



## Smart Applicator in any OCEAN Applicator Feed Style

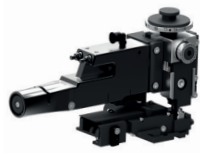

|  | Mechanical                           | Pneumatic        | Servo | Counters |
|--|--------------------------------------|------------------|-------|----------|
| No data transfer                           | OCEAN applicator                     | OCEAN applicator | —     |          |
| Data Management Software (DMS)             | 1                                    | 1                | 5     |          |
| Precision controller (limited integration) | 2                                    | 2                | 6     |          |
| Smart Machine Integration                  | Applicator direct integration   3    | 3                | —     |          |
|  | Precision controller integration   4 | 4                | 7     |          |



View applicator data



Mechanical counter on applicator

Verify applicator data with production\*\*



Electronic count and maintenance data



Smart memory needed



Count incremented

\*\* This feature provides the ability to verify the correct match of the desired production requirement for: terminal part number, crimp height, and wire cross section.

\*\*\* This feature also provides the ability to increment tooling wear counters and set maintenance targets.

Required Part Numbers (see corresponding numbers in above chart)

| Required Part Numbers (see corresponding numbers in above chart) |                                     |   |
|--|-------------------------------------|---|
| 1  | 2161326-1<br>1976700-x              | Smart applicator/OCEAN applicator upgrade kit DMS kit for OCEAN mechanical or pneumatic   |
| 2  | 2161326-1<br>1976800-x              | Smart applicator/OCEAN applicator upgrade kit precision controller kit  |
| 3  | 2161326-1<br>2161651-1<br>2161655-1 | Smart applicator/OCEAN applicator upgrade kit, 1 required per applicator<br>Smart applicator, machine Integration kit; 1 required per machine<br>Smart applicator, applicator direct integration kit; 1 required per station    |
| 4  | 2161326-1<br>2161651-1<br>2161650-1 | Smart applicator/OCEAN applicator upgrade kit, 1 required per applicator<br>Smart applicator, machine integration kit; 1 required per machine<br>Smart applicator, precision controller integration kit; 1 required per station |
| 5  | 1976700-1                           | DMS kit for servo; 1 required per installation  |
| 6  | 1976800-x                           | Precision controller kit  |
| 7  | 2161651-1<br>2161650-1              | Smart applicator, machine integration kit; 1 required per machine<br>Smart applicator, precision controller integration kit; 1 required per station   |

# PREMIUM QUALITY MANUFACTURING OF CRIMP CONNECTIONS

## OCEAN Applicator – Small Wire Crimping $\leq 0.22 \text{ mm}^2 / 24 \text{ AWG}$

### Applicators for small wire sizes

Today's miniaturized terminals demand a high quality applicator in order to meet the requirements of crimp specifications with very small tolerances. The TE OCEAN applicator, with its improved ram alignment, fine adjust crimp height control and other enhancements is well suited to meet these requirements. However, we have added additional features for those applications running small wire sizes (terminals for wire sizes below  $0.35 \text{ mm}^2$  (22 AWG). These features focus on the location control of the crimper and anvil along the axis of the terminal wire barrel. We were able to better control this location by changing the method in which we mount the anvil to the base plate in the applicator. This increased control allows the crimped terminal to more consistently meet

the specification requirements for bellmouth and cutoff tabs, which are commonly controlled with very small tolerances.

Miniaturization of the connectors places higher demands on the processing machines.

Especially the crimp applicator has to fulfill high requirements:

- High mechanical precision
- Repetition accuracy of the terminal feeding system
- Low friction of the ram

Wire Size  $0,13 \text{ mm}^2$  with miniaturized terminal



OCEAN applicator for small terminal is designed to improve the repeatability of the anvil location relative to the ram. This is accomplished by tighter tolerances on several components, special anvil, modified base-plate and a customize shoulder screw to accurately locate the anvil. All other components (including ram and housing) are normal ocean parts.

Terminal hold-down designed specific to terminal body

Feed options – only pneumatic and servo

Terminal strip guide assembly requiring 75 % less set-up and adjustment

Closer fitting terminal drag

Terminal strip guide assembly:

- Closer fitting relative to applicator base plate
- Finer bellmouth / cut-off tab adjustment
- Increased strip guide assembly to applicator base plate engagement
- Reduced clearance between terminal stock thickness and guide plate

Insulation crimp adjustment increments to match that of reduced cable insulation range

Touch Tooling:

- Crimper and ram reduced clearance (closer fitting)
- No crimper spacer minimize tooling stack tolerance build-up
- Shear depressor mount on underside of ram (constant remount height)

Anvil:

- Location by close tolerance shoulder screw
- Repeat position
- Reducing need to adjust terminal strip guide

## OCEAN Applicator – LITEALUM Wire Crimping

### Executive summarize

- In parallel with LITEALUM terminal development, TE application tooling has been developing crimp tooling
- Primary goal: Keep the crimping process the same for crimping aluminum. TE is a terminal manufacturer with this goal, giving to our customers a major competitive advantage

- We have developed a series of applicators that crimp all of the terminals released to date
- We have met a number of challenges and have solutions to each
- We continue to work on future improvements

### Unique applicator features of LITEALUM wire crimping

- Wire crimper with 3-d blend
- Anvil (slightly different has tapered angle)
- Wire depressor (uses special spring-loaded depressor)
- Housing (has cut to mount left side style stripper)
- Modified drag to reduce lateral movement
- Fine adjust insulation adjuster

### Tooling – crimper & anvil

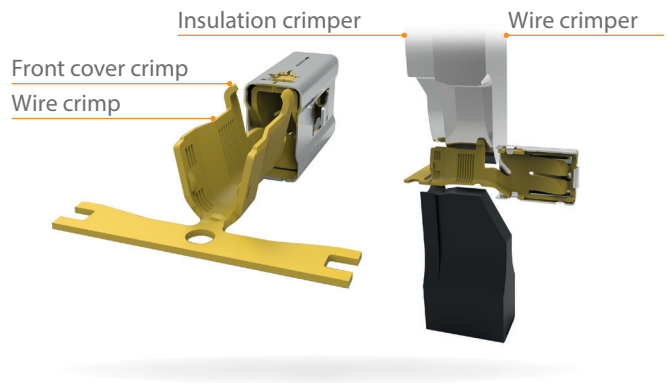

### Value for the customer

OCEAN applicator design, global standard

### OCEAN applicator for MQS terminals

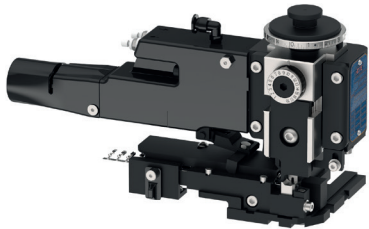

### OCEAN applicator for LITEALUM terminals

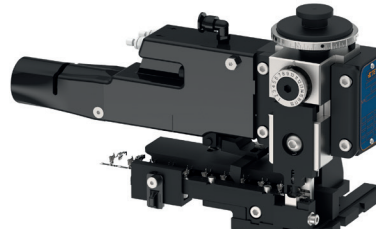

### Special wire crimp profile



# PREMIUM QUALITY MANUFACTURING OF CRIMP CONNECTIONS

## EYE Check Camera

The EYE Check camera is a device to aid in applicator feed setup and terminal alignment. It eliminates your errors. The EYE Check camera is a mounting block for side feed applicators. It's software is compatible for PC and CQM II crimp quality monitor. Most crimping problems relate to feed.

block for

### Correct Alignment

- Reduces scrap
- Contributes to better crimp cross sections
- Is a major contributor to longer tooling life
- Increases machine-up time by eliminating adjustments during production

### Equipment Facts

- PC or CQM II compatible
- Camera Size: 11 mm x 120 mm
- Resolution: 1600 x 1200 pixels
- Manual focus
- Angle of view: 60°

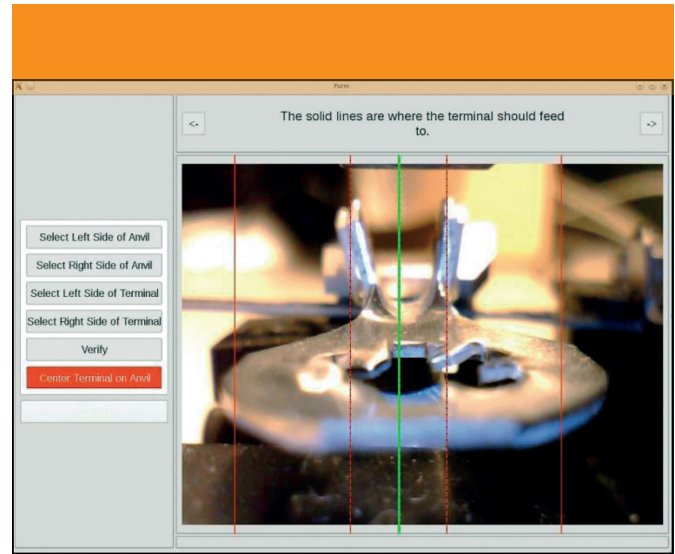

EYE Check camera  
PN 2217834-1  
actual component

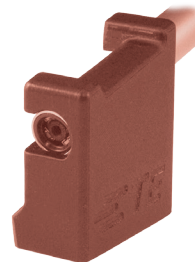
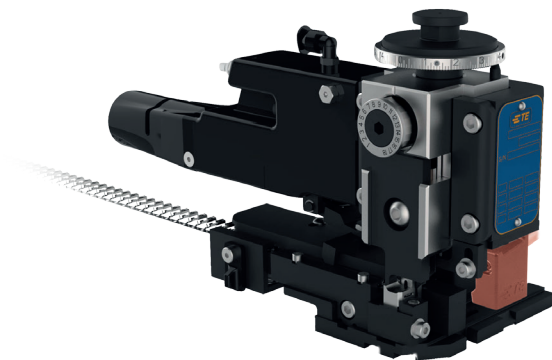

Visualization of EYE Check  
camera installation

# EYE Check Alignment Monitoring

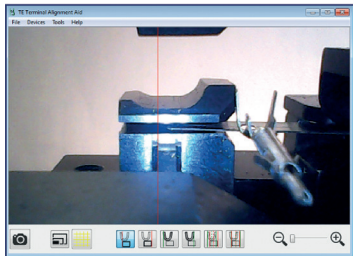

Select the left side of the anvil

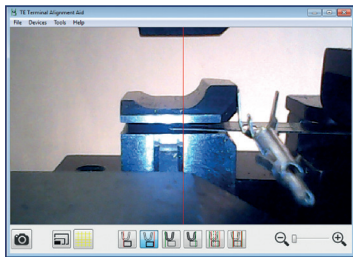

Select the right side of the anvil

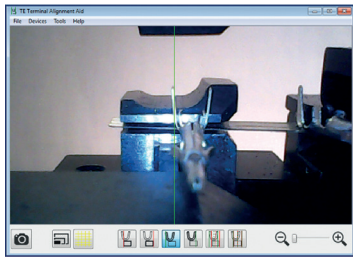

Select the left side of the wire barrel

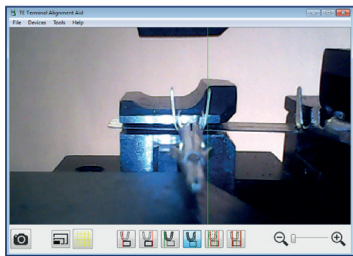

Select the right side of the wire barrel

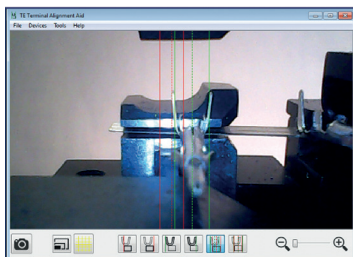

Confirm selections

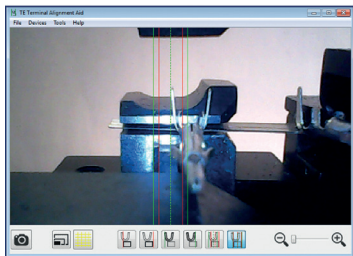

Adjust terminal using guides

## Under Feeding

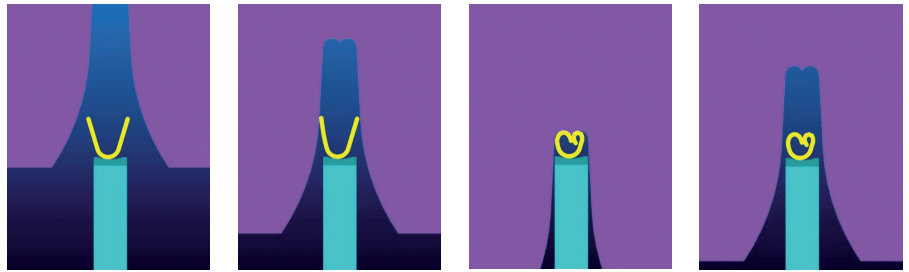

## Over Feeding

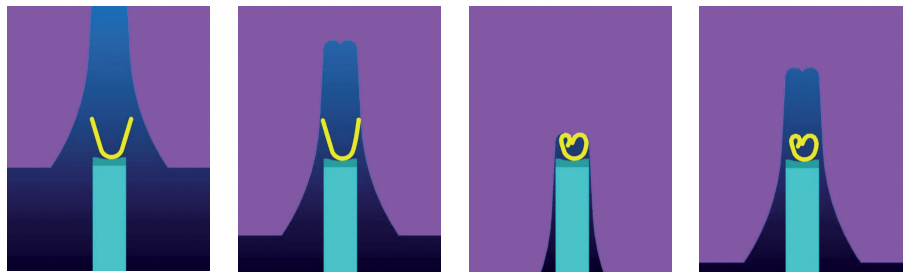

## Perfect Feeding

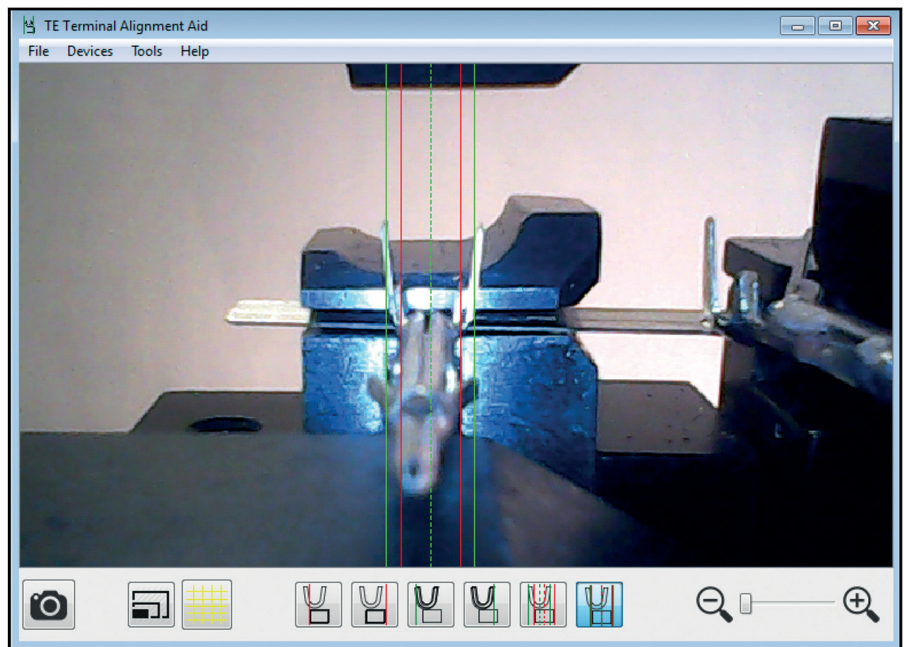
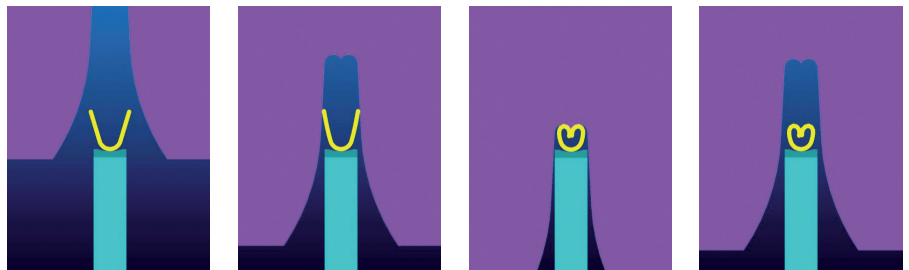

# PREMIUM QUALITY MANUFACTURING OF CRIMP CONNECTIONS

## TE CrimpData App

Our OCEAN applicator offering just got a whole lot more flexible thanks to TE CrimpData. With this mobile app you can manage applicator and spare parts inventory, and quickly verify that you have the right applicator for your terminal without having to run back to your desk. And it's completely free to download from your smart phone or tablet's app store!

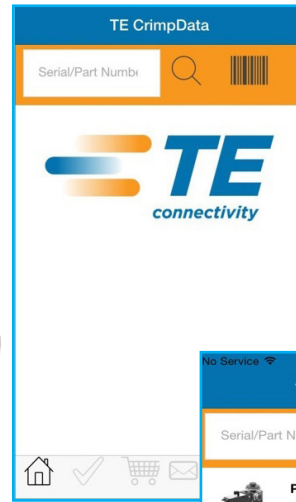

- Get part numbers of spare parts
- Set individual cycle count of spare parts
- Coming soon (order spare parts)

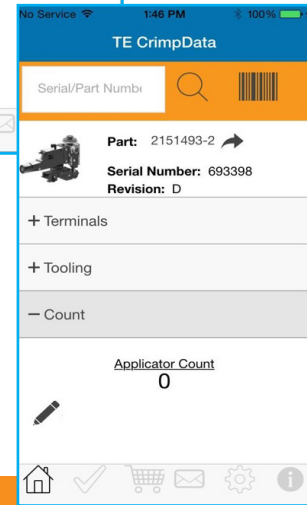

### What can it do?

- Reads the new data matrix barcode on applicator tags to provide the latest crimp information.
- Provides compatibility verification between terminals and tooling
- Scans and looks up applicator and terminal information
- Enables you to record cycles on the applicator and spare parts

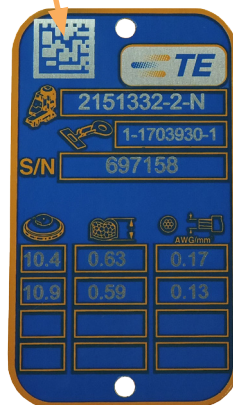

2D datamatrix barcode ID tag

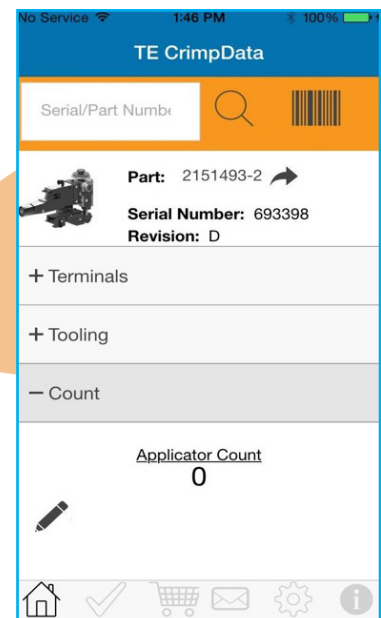

## TE CrimpData App

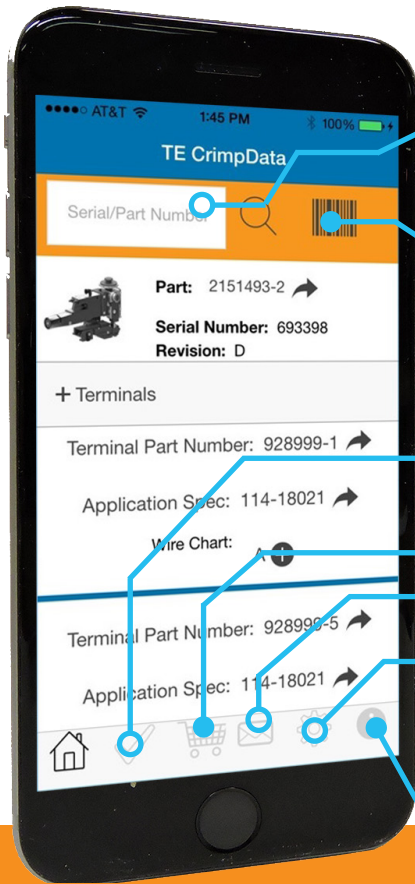

The TE CrimpData app is available on both the iPhone and Android platforms. Search for "TE CrimpData" to locate and download the App.

### Manual Search Functionality

Don't have a QR code? No problem. Manually enter the serial or part number and search the database for applicator and terminal specs.

### Barcode Scanner

Click, scan and search with the touch of a button.

### The Right Tool for the Job

TE CrimpData can help you quickly cross reference the applicator to your terminal and verify if it's the right match.

### Order Parts

Ready to check out? TE CrimpData allows you to find and order compatible spare tooling. (coming soon)

### Sharing Tool

Quickly launch your email to send order details to yourself or someone else.

### Stay on Track

Track and edit applicator and individual cycle counts for spare tooling.

### Power of the Cloud

TE CrimpData connects to TE.com and provides a wealth of information like wire size charts, and application specifications.

| PRODUCT |   |
|---------|---|
|         | Application Tooling - OCEAN Applicators<br><b>CRIMPER, WIRE .130 "F"</b><br>- 456410-4<br>TE INTERNAL NUMBER: 456410-4<br>✓ Active  |
|         | Not in Scope for EU RoHS/ELV Compliance<br>Region <b>Worldwide</b><br>Tool Type <b>Applicator</b><br>Spare Parts Tooling <b>Yes</b><br>Spare Parts Tool Type <b>Crimper</b> |



Manage inventory and stay productive all with the power of the TE CrimpData app.

# PREMIUM QUALITY MANUFACTURING OF CRIMP CONNECTIONS

## Effective Crimp Performance

### Detachable Lubricator Assembly

It is easy to overlook, but routine greasing can be a factor in reducing production downtime. Checking tooling – inspecting crimpers and anvils – before they break also will support production continuity.

Just as with any machinery, lubrication of the applicator reduces wear and even protects against corrosion.

Specific use of contact lubricant on terminals prevents the friction that can lead to sticking in the crimper, bent terminals, and premature crimper wear.

- Assembly for side feed and end feed versions are available
- Simple attachment
- Broad wick and variable adjustments for complete terminal coverage
- Clear composite shell for easy viewing of lubricant levels

| Description        | Part Number |
|--------------------|-------------|
| Side feed assembly | 2119955-1   |
| End feed assembly  | 2119955-2   |

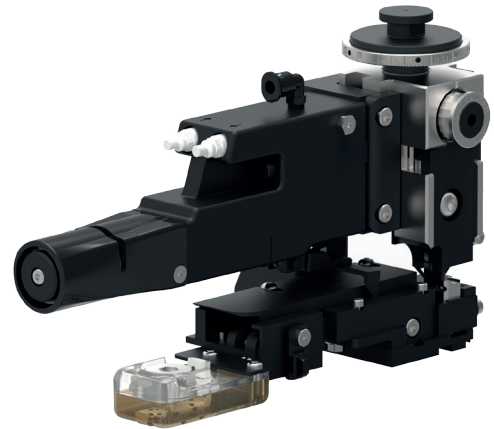

### Transporting Applicators Safely

Although applicators are manufactured to withstand the impact of crimping, crimpers and anvils must not contact each other. Such contact can scrape the plating or the crimping surface, causing a friction point. Friction points can form metal buildup, ultimately causing reject crimps and even tool breakage.

This problem is easily avoided. Always leave a terminal in the crimp tooling when moving the applicator from one location to another. This allows the terminal to receive any possible contact and protects the tooling.

The collar protects the applicator from unwanted motions and damages.

| Description   | Part Number |
|---|-------------|
| Collar orange-standard TE color delivered with the applicator | 2119783-1   |
| Collar red – order separately                                 | 2119783-2   |
| Collar green – order separately                               | 2119783-3   |

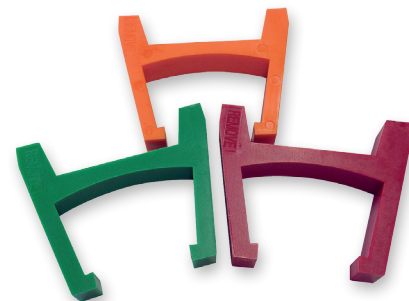
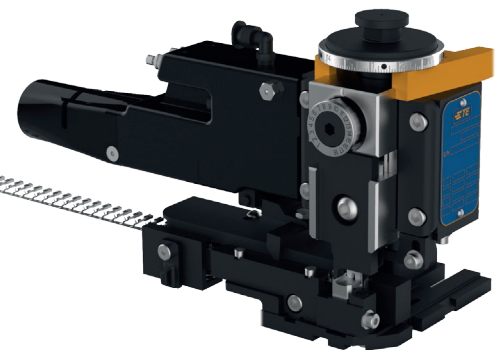



## Effective Crimp Performance

OCEAN applicators are dedicated to providing high quality crimp connections to meet corresponding specifications.

OCEAN applicator gauges ensure the correct applicator alignment to produce high quality crimp connections.

| Description                       | Part Number |
|-----------------------------------|-------------|
| OCEAN Applicator Gauge, Side Feed | 2161422-2   |
| OCEAN Applicator Gauge, End Feed  | 2161422-3   |

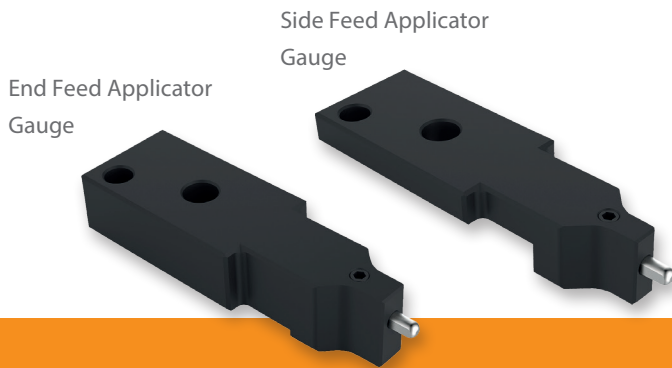

Side Feed Applicator with Gauge built in

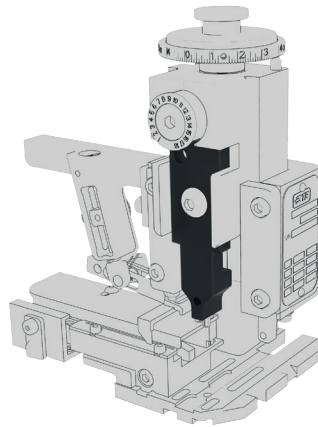

End Feed Applicator with Gauge built in

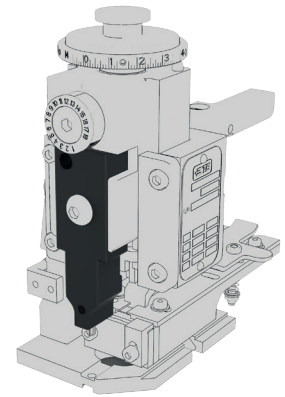

### Gauges

Compatible with TE Connectivity and commercially available crimping presses, using quick changes style applicators.

### Applicator Gauge

Ideal instrument to assure correct positioning of all TE applicators

- Connectivity applicators
- Simple installation and use

| Description                      | Part Number |
|----------------------------------|-------------|
| ApplicatorGaugeKit,CrimpMachines | 528440-5    |



# PREMIUM QUALITY MANUFACTURING OF CRIMP CONNECTIONS

## Selecting an Applicator Online

A convenient lookup function on the TE website will guide you through applicator selection and provide access to all necessary documents and drawings.

[www.te.com/usa-en/products/application-tooling/mini-applicator-parts-search.html](http://www.te.com/usa-en/products/application-tooling/mini-applicator-parts-search.html)

If you do not find an applicator to meet your requirements, please refer to [www.te.com/support-center](http://www.te.com/support-center)

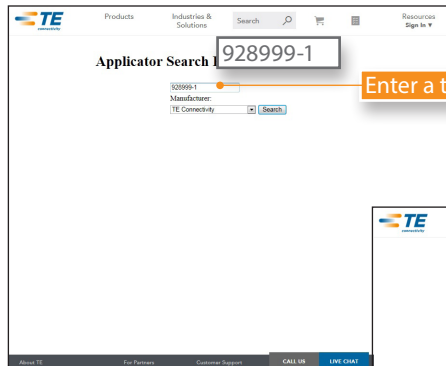

Enter a terminal PN.

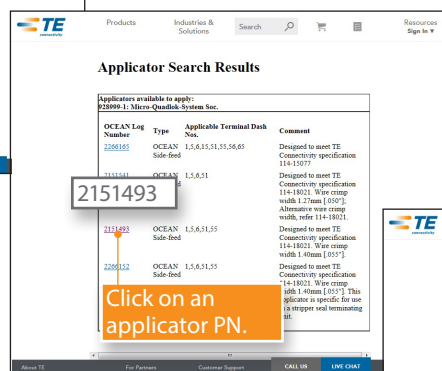

Click on an applicator PN.

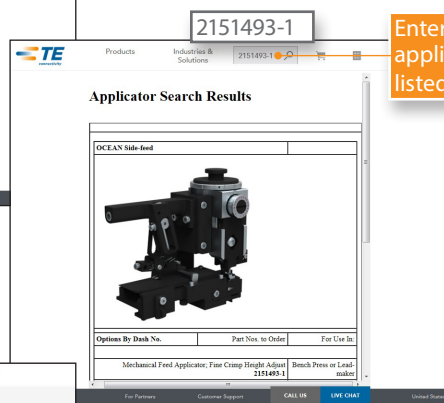

Enter a complete applicator PN as listed below.

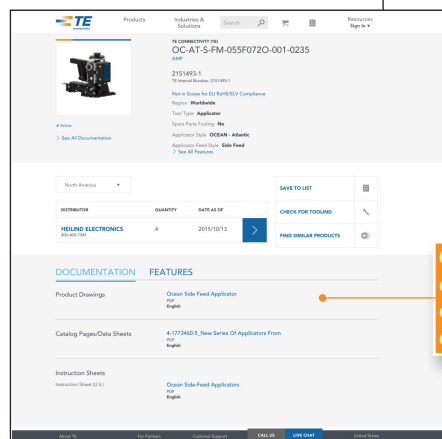

Click on a pdf and open customer drawing with crimp data or further documentation.

## Selecting Replaceable Tooling Online

Only by the use of genuine TE Connectivity tooling can you be assured of a long-lasting tool life and very reliable production. The design, materials, and manufacturing quality of TE tooling translate directly into fewer rejects, fewer breakdowns and interruptions.

To determine the tooling part number for a specific applicator, simply set your web browser to

[www.te.com/global-en/products/application-tooling/applicator-spare-parts-search.html](http://www.te.com/global-en/products/application-tooling/applicator-spare-parts-search.html)

Enter the applicator part number, and click on Search Parts. The part numbers of replaceable tooling will be displayed.

The same lookup allows you to enter the part number of a crimper and find out what applicators is suitable for it.

**1**

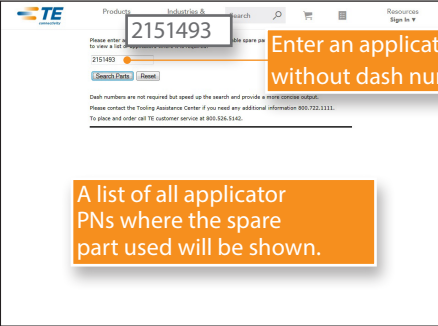

Enter an applicator PN without dash numbers.

A list of all applicator PNs where the spare part used will be shown.

**2**

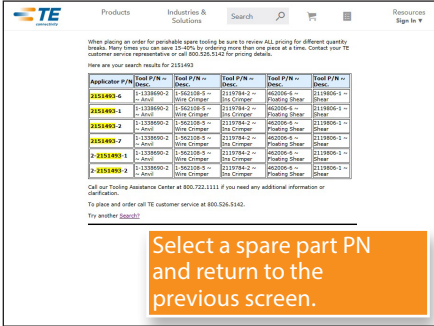

Select a spare part PN and return to the previous screen.

**3**

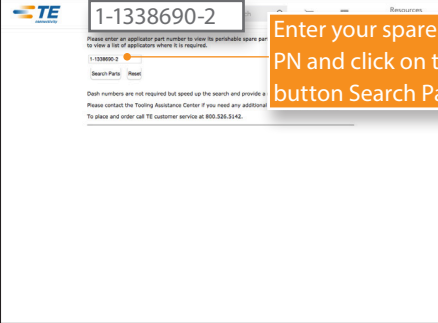

Enter your spare part PN and click on the button Search Parts.

**4**

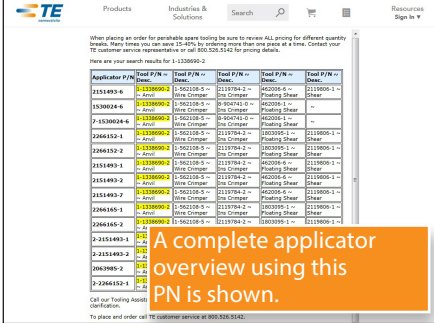

A complete applicator overview using this PN is shown.

[www.te.com/commerce/DocumentDelivery/DDEController](http://www.te.com/commerce/DocumentDelivery/DDEController)

**5**

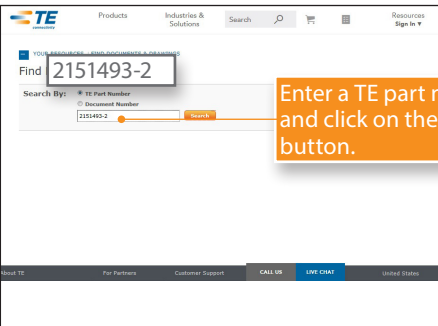

Enter a TE part number and click on the search button.

**6**

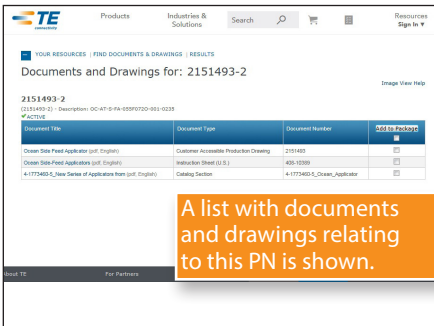

A list with documents and drawings relating to this PN is shown.

**7**

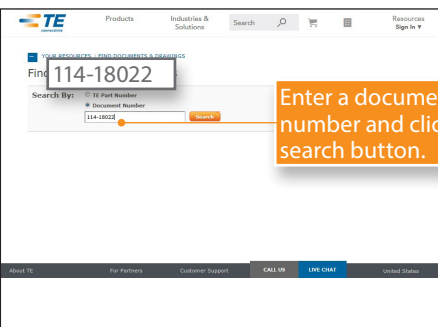

Enter a document number and click on the search button.

**8**

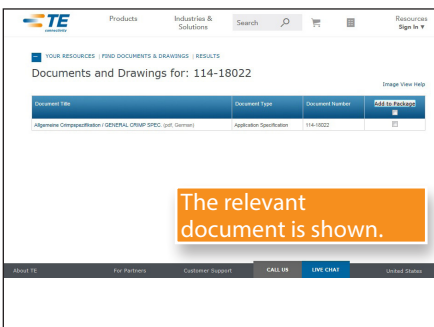

The relevant document is shown.

## Let's Connect

To learn more about our comprehensive line of tooling solutions, please visit us at [www.tooling.te.com](http://www.tooling.te.com).



## TE Technical Support Center

|                  |                   |              |                  |
|------------------|-------------------|--------------|------------------|
| USA:             | 1.800.522.6752    | UK:          | +44.0800.267666  |
| Canada:          | 1.800.522.6752    | France:      | +33.1.34.20.8686 |
| Mexico:          | +52.55.11.06.0800 | Netherlands: | +31.73.624.6999  |
| Latin/S. America | +54.11.4733.2200  | China:       | +86.400.820.6015 |
| Germany:         | +49.6151.607.1999 |              |                  |

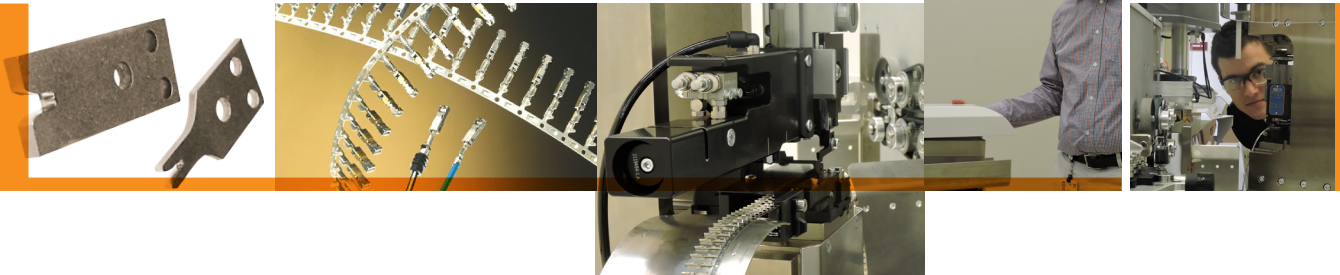

### Waste Not. Want Not.

Whether it's time or scrap, in manufacturing everyone knows that waste costs money. With our on-site certification and consultation services, we can help you:

- Reduce downtime
- Reduce scrap
- Maintain crimp quality
- Improve manufacturing efficiency

Connect with us today to learn more.

- E-mail: [fieldservicesnorthamerica@te.com](mailto:fieldservicesnorthamerica@te.com)
- Phone: 800-722-1111 or 717-986-3434
- For additional information download catalog number 1-1307619-0 from [www.tooling.te.com](http://www.tooling.te.com).



### Time is Money.

In manufacturing downtime can be expensive. That's why TE is constantly working to improve product availability and delivery rates. With a strong global footprint, short lead times and a strong distribution channel, TE has the equipment and the accessories to keep production online.

To check distributor stock and availability for your tooling needs go to:  
<http://www.te.com/commerce/sck/cdi.do>

## tooling.te.com

1-1773864-9 / Revised 10-15 © 2015 TE Connectivity Ltd. family of companies. All Rights Reserved. AMP, EYE Check, LITEALUM, OCEAN, RAYCHEM, SOLARLOK, TE Connectivity and TE connectivity (logo) are trademarks. Crimpmatic is a trademark. iButton and MOST are trademarks. Other product and/or crimping names herein might be trademarks of their respective owners.

# Mouser Electronics

Authorized Distributor

Click to View Pricing, Inventory, Delivery & Lifecycle Information:

[TE Connectivity:](#)

[1852811-1](#)