

THIS DRAWING IS UNPUBLISHED. RELEASED FOR PUBLICATION 20
 © COPYRIGHT 20 BY - ALL RIGHTS RESERVED.

ITEM	DESCRIPTION	MATERIAL	OTHERS
1	FEMALE CONTACT	COPPER ALLOY	FLASH GOLD
2	HOUSING	NYLON	BLACK
3	COUPLING NUT	COPPER ALLOY	-
4	OVER-MOLDING	POLYURETHANE	BLUE
5	CABLE	-	-
6	LABEL	-	-

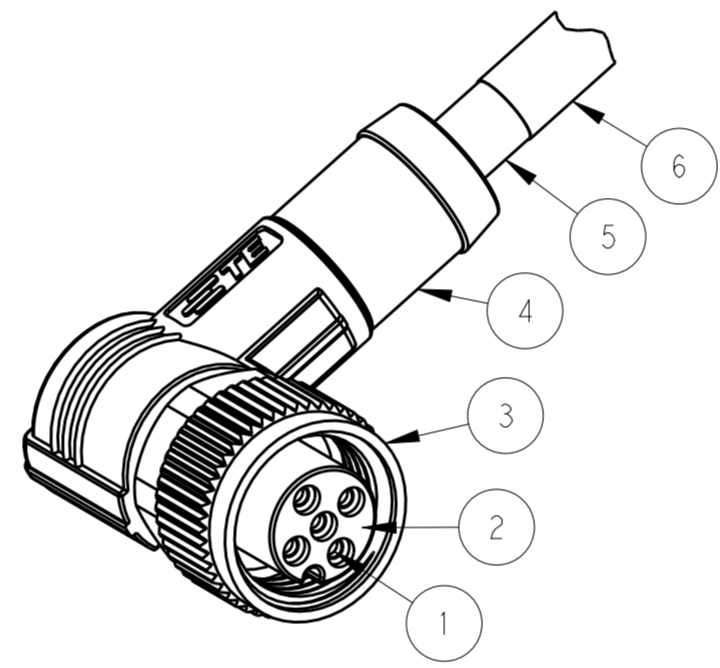
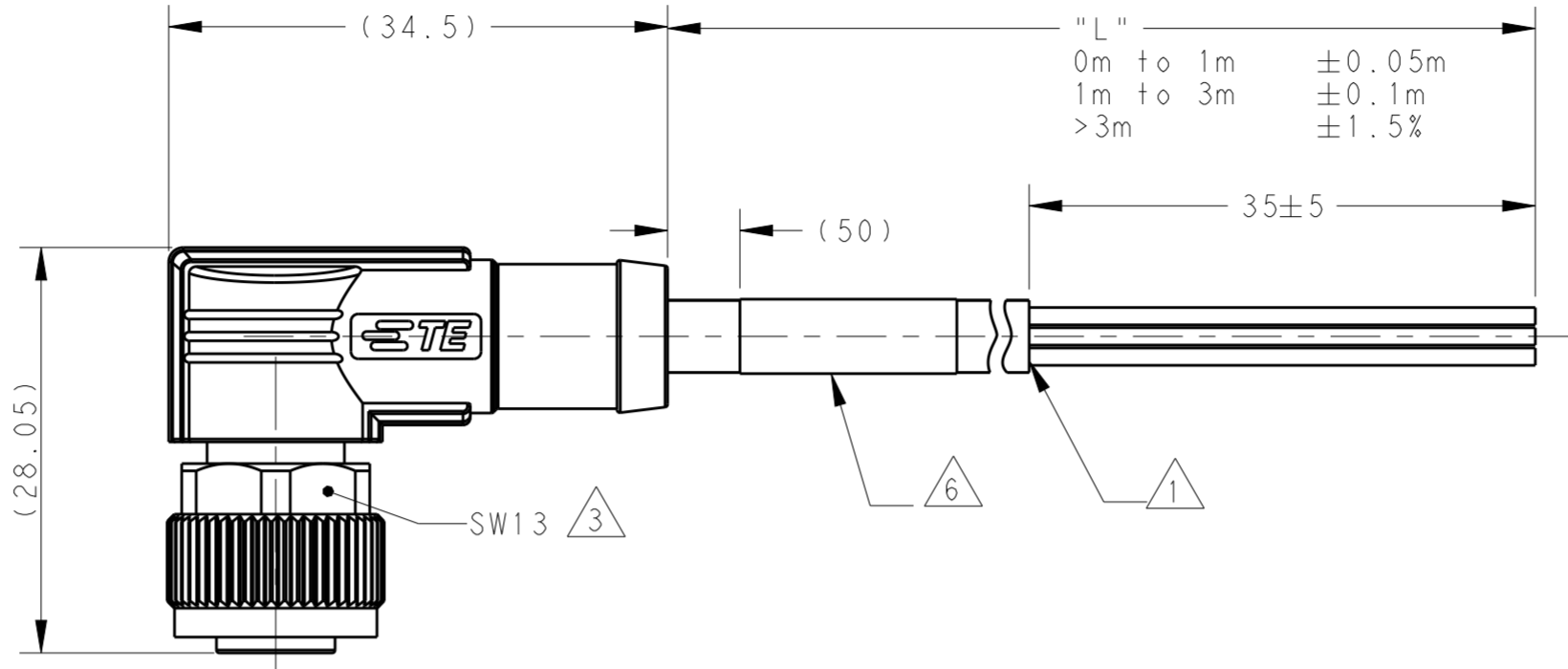
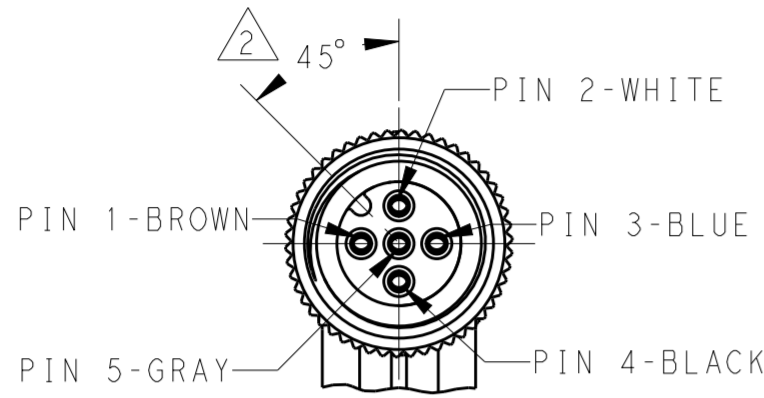

REVISIONS					
P	LTR	DESCRIPTION	DATE	DWN	APVD
	A	INITIAL RELEASE	21AUG2015	HW	XX
	A1	ECR-16-010106	14JUL2016	HW	XX
	A2	ECR-16-015173, ADD NEW PN	29OCT2016	BP	CW
	B	ECR-18-019963	28DEC2018	G.W	C.W

NOTE:
 ①. STRIP ALL THE INSULATION;
 ②. CODE POSITION INDICATOR;
 ③. RECOMMENDED TORQUE 0.6 Nm;
 ④. -** : CABLE LENGTH
 -0.5:0.5M,
 -1.0:1.0M,
 -1.5:1.5M,
 -3.0:3.0M,
 -5.0:5.0M,
 -7.0:7.0M,
 -10.0:10.0M;
 5. CABLE ASSEMBLY TO BE PACKAGED IN POLYBAGS:
 ⑥. LABEL CONTAINS: PN, DATE CODE...;
 ⑦. -00X: FOR CABLE LENGTH, SEE TABLE E AND REFER TO LENGTH "L".

注释:
 ①. 全剥护套绝缘层;
 ②. CODE位置指示;
 ③. 推荐扭矩0.6 Nm;
 ④. -** : 线缆长度
 -0.5:0.5M,
 -1.0:1.0M,
 -1.5:1.5M,
 -3.0:3.0M,
 -5.0:5.0M,
 -7.0:7.0M,
 -10.0:10.0M;
 5. 线缆组件塑料袋包装;
 ⑥. 标签包含: 产品编号, 日期代码...;
 ⑦. -00X: 线缆长度, 参考表2, 参照长度 "L".

TECHNICAL DATA				
	T41514X0002-00X	T41514X0003-00X	T41514X0004-00X	T41514X0005-00X
RATED VOLTAGE		250V		60V
RATED IMPULSE VOLTAGE		2500V		1500V
RATED CURRENT			4A	
POLLUTION DEGREE			3	
OVERVOLTAGE CATEGORY			II	
MATERIAL GROUP			II	
DEGREE OF PROTECTION			IP67	

PIN ARRANGEMENT A-CODE		
T41514X0002-00X	T41514X0003-00X	T41514X0004-00X
T41514X0005-00X		

WIRES	STANDARD	TEMP. RANGE	JACKET COLOR	JACKET MATERIAL	TYPE	POS.	TE PN
WIRES: 0.50mm ² (20AWG) WIRE COLOR: WH/BR/BK/BL/GR OD: APPROX.4.5MM FOR 2P/3P APPROX.5.0MM FOR 4P/5P	STANDARD: -001:0.5 M -002:1.0 M -003:1.5 M -004:3.0 M -005:5.0 M -006:7.0 M -007:10.0 M	FIXED: -10°C~+80°C FLXIBLE: -5°C~+80°C	BLACK	PVC (UL)	RPC-M12-FR-5CON-PVC-**S0.5④	5	T4151450005-00X⑦
					RPC-M12-FR-4CON-PVC-**S0.5④	4	T4151450004-00X⑦
					RPC-M12-FR-3CON-PVC-**S0.5④	3	T4151450003-00X⑦
					RPC-M12-FR-2CON-PVC-**S0.5④	2	T4151450002-00X⑦
					RPC-M12-FR-5CON-PUR-**④	5	T4151420005-00X⑦
					RPC-M12-FR-4CON-PUR-**④	4	T4151420004-00X⑦
					RPC-M12-FR-3CON-PUR-**④	3	T4151420003-00X⑦
					RPC-M12-FR-2CON-PUR-**④	2	T4151420002-00X⑦
					RPC-M12-FR-5CON-PVC-**④	5	T4151410005-00X⑦
					RPC-M12-FR-4CON-PVC-**④	4	T4151410004-00X⑦
					RPC-M12-FR-3CON-PVC-**④	3	T4151410003-00X⑦
					RPC-M12-FR-2CON-PVC-**④	2	T4151410002-00X⑦
CABLE CHARACTERISTIC	LENGTH "L"	CABLE TEMP. RANGE	JACKET COLOR	JACKET MATERIAL	TYPE	POS.	TE PN

THIS DRAWING IS A CONTROLLED DOCUMENT.

DIMENSIONS: mm	TOLERANCES UNLESS OTHERWISE SPECIFIED:	DWN HAO WANG 11AUG2015	TE Connectivity NAME M12X1 RA RECEPTACLE, FREE END A-CODE, UNSHIELDED, SIZE CAGE CODE DRAWING NO RESTRICTED TO A2 - C-T41514X00XX00X SCALE 2:1 SHEET 1 OF 1 REV B
		CHK KOBBY ZHAO 11AUG2015	
		APVD XIANG XU 11AUG2015	
		PRODUCT SPEC 108-106140	
MATERIAL	FINISH	APPLICATION SPEC	CUSTOMER DRAWING

Mouser Electronics

Authorized Distributor

Click to View Pricing, Inventory, Delivery & Lifecycle Information:

[TE Connectivity:](#)

[T4151420005-001](#)