

THIS DRAWING IS UNPUBLISHED. RELEASED FOR PUBLICATION 20
 © COPYRIGHT 20 BY - ALL RIGHTS RESERVED.

T.E. PROPRIETARY AND CONFIDENTIAL
 This drawing contains proprietary information that shall not be disclosed, duplicated nor used in whole or in part for any purpose other than to evaluate this drawing.

LOC		DIST		REVISIONS			
P	LTR	DESCRIPTION	DATE	DWN	APVD		
A		REVISED PER E.O. C8206	110510	-	RB		
B		UPDATED PER ECO-14-008850	140611	CB	EA		
C		UPDATED PER ECO-16-000868	160126	MJ	EA		

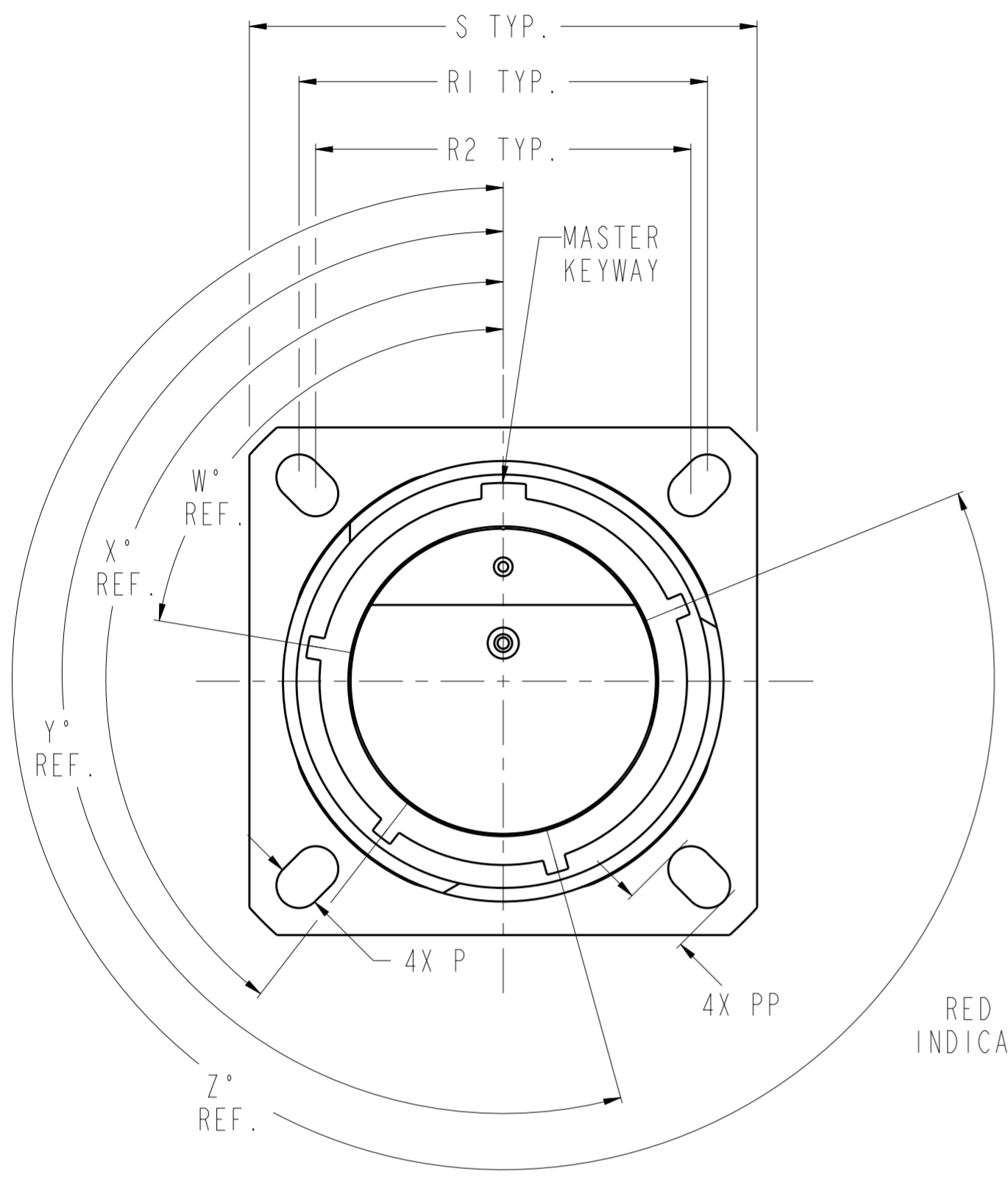

EXAMPLE OF PART NUMBER
 DTS 20 x xx - xx P/S x-xxxx

MODIFICATION
 KEYING POSITION
 N = NORMAL, A, B, C, D & E
 CONTACT STYLE
 P = PIN S = SOCKET
 A = LESS PIN B = LESS SOCKET
 H = 1500 CYCLES - PIN J = 1500 CYCLES - SOCKET
 INSERT ARRANGEMENT
 SHELL SIZE
 CLASS F = NICKEL
 G = NICKEL SPACE GRADE
 T = TEFLON NICKEL
 W = OLIVE DRAB CADMIUM
 Z = ZINC NICKEL
 SHELL STYLE
 20 = SQUARE FLANGE RECEPTACLE
 CONNECTOR SERIES
 DEUTSCH MIL-DTL-38999 SERIES III

- FOR AVAILABILITY CONSULT FACTORY. (C1)
- FOR APPLICABLE KEYING DIAGRAM AND PANEL CUTOUT DIMENSIONS, SEE MIL-DTL-38999. FOR AVAILABLE INSERT ARRANGEMENTS, SEE MIL-STD-1560.
- GENERAL SPECIFICATIONS: THIS CONNECTOR MEETS THE PERFORMANCE AND INTERMATEABILITY REQUIREMENTS OF MIL-DTL-38999, SERIES III.
- MATERIAL / FINISH: SHELL - ALUMINUM ALLOY / PLATING PER EXAMPLE PART NUMBER DESCRIPTION.
 RESILIENT INSERTS - SILICONE ELASTOMER
 PLASTIC INSERTS - THERMOPLASTIC.
 CONTACTS - COPPER ALLOY / GOLD PLATED.
- ALL DIMENSIONS ARE IN INCHES UNLESS OTHERWISE SPECIFIED. THREAD CALLOUTS ARE METRIC.

SIZE	KEYING DESIGNATION LETTER	W°	X°	Y°	Z°
9	N	105	140	215	265
	A	102	132	248	320
	B	80	118	230	312
	C	35	140	205	275
	D	64	155	234	304
11, 13 AND 15	N	95	141	208	236
	A	113	156	182	292
	B	90	145	195	252
	C	53	156	220	255
	D	119	146	176	298
17, 19, 21, 23 AND 25	N	80	142	196	293
	A	135	170	200	310
	B	49	169	200	244
	C	66	140	200	257
	D	62	145	180	280
E	79	153	197	272	

PART NUMBER	SIZE	D THREAD	P+.004 -.002	PP+.004 -.002	R1	R2	S±.011	V MAX.	W MAX.
DTS20x09-xxP/Sx	09	M12X1.0-6g 0.100R	.128	.216	.719	.594	.937	.822	.098
DTS20x11-xxP/Sx	11	M15X1.0-6g 0.100R	.128	.194	.812	.719	1.031	.822	.098
DTS20x13-xxP/Sx	13	M18X1.0-6g 0.100R	.128	.194	.906	.812	1.126	.822	.098
DTS20x15-xxP/Sx	15	M22X1.0-6g 0.100R	.128	.173	.969	.906	1.220	.822	.098
DTS20x17-xxP/Sx	17	M25X1.0-6g 0.100R	.128	.194	1.062	.969	1.311	.822	.098
DTS20x19-xxP/Sx	19	M28X1.0-6g 0.100R	.128	.194	1.156	1.062	1.437	.822	.098
DTS20x21-xxP/Sx	21	M31X1.0-6g 0.100R	.128	.194	1.250	1.156	1.563	.791	.126
DTS20x23-xxP/Sx	23	M34X1.0-6g 0.100R	.154	.242	1.375	1.250	1.689	.791	.126
DTS20x25-xxP/Sx	25	M37X1.0-6g 0.100R	.154	.242	1.500	1.375	1.811	.791	.126

NOTES:

THIS DRAWING IS A CONTROLLED DOCUMENT.

DWN: EHAB ALAWNEH 070410
 CHK: JAMES FRIEDHOF 070523
 APVD: ALEX RENGLEO 110511

STE TE Connectivity

NAME: DTS SQUARE FLANGE ENVELOPE

PRODUCT SPEC: -
 APPLICATION SPEC: -
 WEIGHT: -

MATERIAL: SEE NOTE 2
 FINISH: SEE NOTE 2

SIZE: A2
 CAGE CODE: -
 DRAWING NO: C-DTS20xxx-xxP/Sx
 RESTRICTED TO: -

SCALE: 2.500 SHEET 1 OF 1 REV C

Mouser Electronics

Authorized Distributor

Click to View Pricing, Inventory, Delivery & Lifecycle Information:

[TE Connectivity:](#)

[DTS20W15-35PN](#)