

P	LTR	DESCRIPTION	DATE	DWN	APVD
A		RELEASED FOR PRODUCTION	06AUG2019	RK	PS

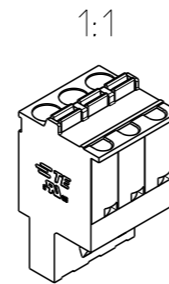
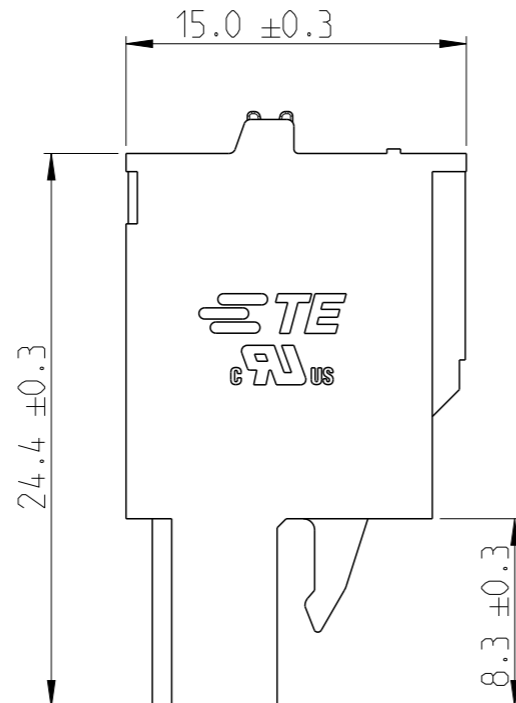
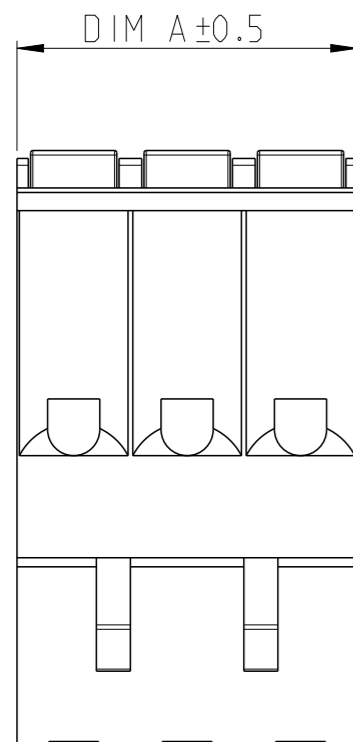

NOTES:

- MATERIALS & FINISH  
 HOUSING : PA66, UL94 V0, COLOR - GREEN  
 PUSH BUTTON : PA66, COLOR - ORANGE.  
 CONTACT : COPPER ALLOY, TIN PLATED  
 SPRING : STAINLESS STEEL
- MECHANICAL  
 WIRE STRIPPING LENGTH : 12-13 mm
- ELECTRICAL  
 WIRE RANGE : 12-26 AWG  
 RATED VOLTAGE : 300V  
 RATED CURRENT : 16A  
 INSULATION RESISTANCE : >2000 M Ohm (500V DC)
- OPERATING TEMPERATURE RANGE : -40°C TO +105°C

△ 5 TOLERANCE NOT CUMULATIVE

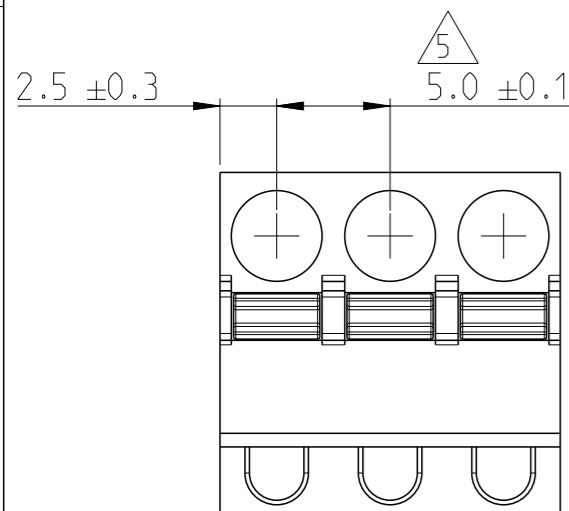

80.0	16	1-2350397-6
75.0	15	1-2350397-5
70.0	14	1-2350397-4
65.0	13	1-2350397-3
60.0	12	1-2350397-2
55.0	11	1-2350397-1
50.0	10	1-2350397-0
45.0	9	2350397-9
40.0	8	2350397-8
35.0	7	2350397-7
30.0	6	2350397-6
25.0	5	2350397-5
20.0	4	2350397-4
15.0	3	2350397-3
10.0	2	2350397-2
DIM A	NO. OF POS	PART NUMBER

THIS DRAWING IS A CONTROLLED DOCUMENT.		DWN 08APR2019 RAGHAVENDRA.K	TE Connectivity			
DIMENSIONS: mm		CHK 01JUL2019 KARTHIK.JK				
TOLERANCES UNLESS OTHERWISE SPECIFIED:		APVD 02JUL2019 PRASHANH.S	NAME SPRING FEMALE PLG, GREEN 5.00mm PITCH			
0 PLC ± 1 PLC ± 2 PLC ± 3 PLC ± 4 PLC ± ANGLES ±		PRODUCT SPEC -	APPLICATION SPEC -			
MATERIAL SEE NOTES		WEIGHT -	SIZE A3	CAGE CODE 00779	DRAWING NO C-2350397	RESTRICTED TO -
-		CUSTOMER DRAWING		SCALE 3:1	SHEET 1 OF 1	REV A

# Mouser Electronics

Authorized Distributor

Click to View Pricing, Inventory, Delivery & Lifecycle Information:

[TE Connectivity:](#)

[1-2350397-2](#)