

REVISIONS

P	LTR	DESCRIPTION	DATE	DWN	APVD
A1		CURRENT RATING CORRECTED FROM 11A TO 15 A	27JAN2020	RK	PS

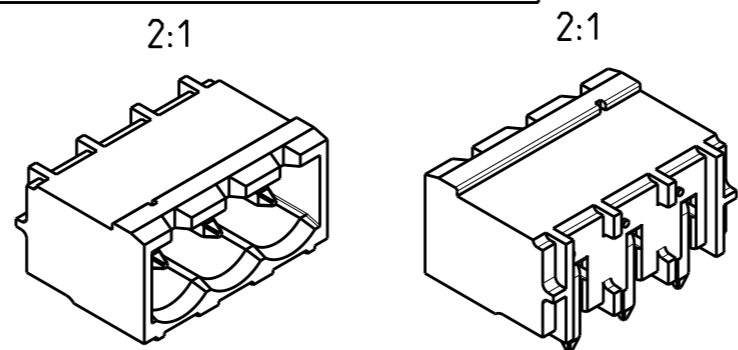
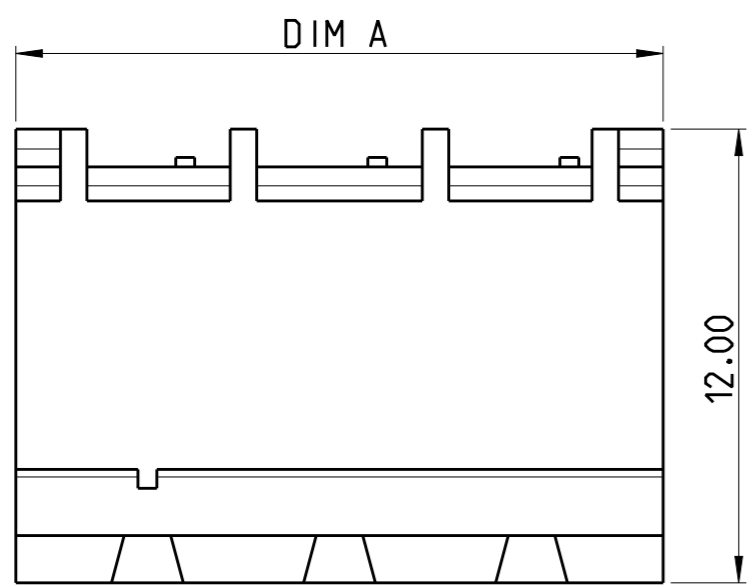

NOTES:

- MATERIAL AND FINISH:
HOUSING : HIGH TEMPERATURE POLYAMIDE, UL94V-0
COLOR BLACK.
TERMINAL : COPPER ALLOY, TIN PLATED.
- MECHANICAL
MIN. PC BOARD HOLES DIAMETER : 1.6 mm
MAX. PC BOARD THICKNESS : 2.4 mm
- ELECTRICAL
MAX. VOLTAGE : 300 V
MAX CURRENT : 15 A
CONTACT RESISTANCE : <15 m Ohm
INSULATION RESISTANCE : >1000 M Ohm (500V DC)
- OPERATING TEMPERATURE RANGE: -40°C TO +105°C
- NOT CUMULATIVE TOLERANCE.
- PARTS ARE PACKED IN BOX.

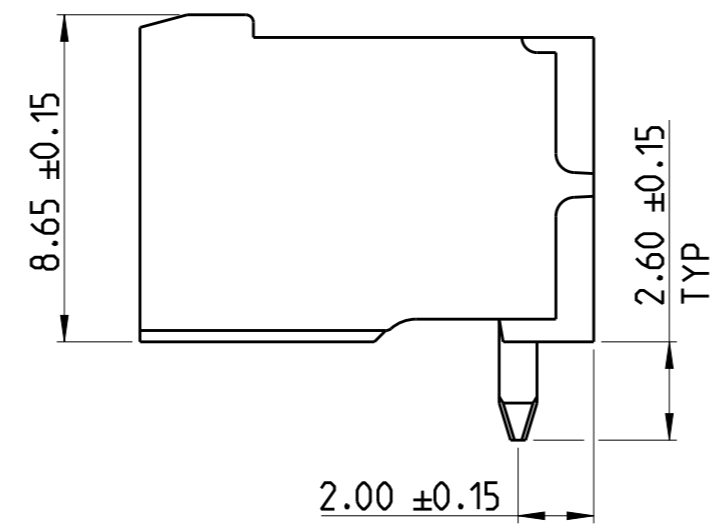
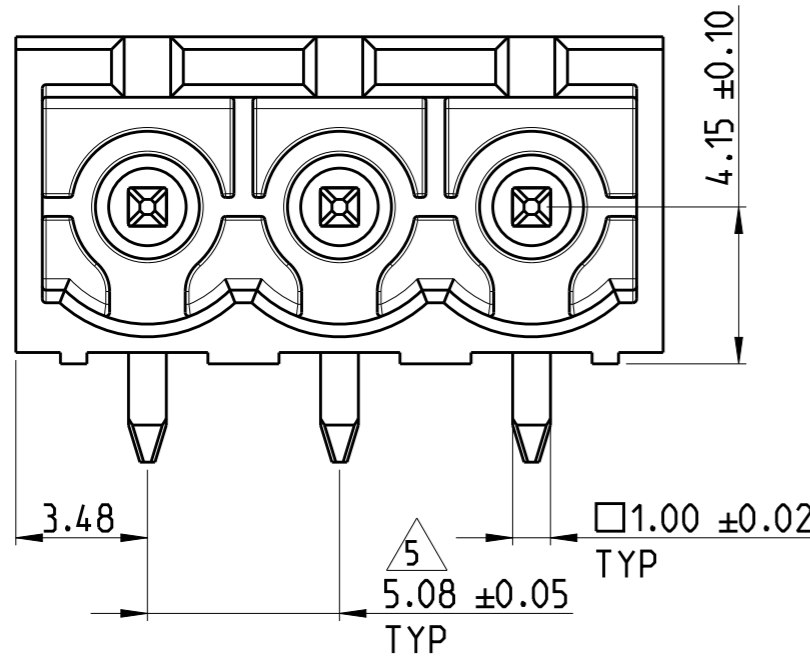

128.88	25	2-2342083-5
123.80	24	2-2342083-4
118.72	23	2-2342083-3
113.64	22	2-2342083-2
108.56	21	2-2342083-1
103.48	20	2-2342083-0
98.40	19	1-2342083-9
93.32	18	1-2342083-8
88.24	17	1-2342083-7
83.16	16	1-2342083-6
78.08	15	1-2342083-5
73.00	14	1-2342083-4
67.92	13	1-2342083-3
62.84	12	1-2342083-2
57.76	11	1-2342083-1
52.68	10	1-2342083-0
47.60	9	2342083-9
42.52	8	2342083-8
37.44	7	2342083-7
32.36	6	2342083-6
27.28	5	2342083-5
22.20	4	2342083-4
17.12	3	2342083-3
12.04	2	2342083-2
DIM A	NO. OF POS	PART NUMBER

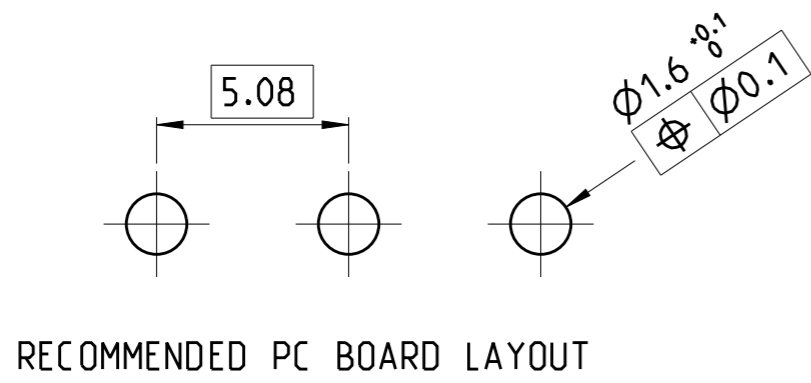

THIS DRAWING IS A CONTROLLED DOCUMENT.

DIMENSIONS:	TOLERANCES UNLESS OTHERWISE SPECIFIED:
mm	
	0 PLC ±0.3
	1 PLC ±0.25
	2 PLC ±0.25
	3 PLC ±0.25
	4 PLC ±0.25
	ANGLES ±2°
MATERIAL	FINISH
SEE NOTES	SEE NOTES

DWN	17DEC 2018
CHK	RAGHAVENDRA.K
APVD	19DEC 2018
PRASHANTH.S	
PRODUCT SPEC	
APPLICATION SPEC	
WEIGHT	-
CUSTOMER DRAWING	

TE TE Connectivity

NAME: HEADER 90 DEG. HIGH TEMPERATURE, 5.08MM PITCH, TAIL LENGTH 2.6mm

SIZE	CAGE CODE	DRAWING NO	RESTRICTED TO
A3	00779	C-2342083	-

SCALE 5:1 SHEET 1 OF 1 REV A1

Mouser Electronics

Authorized Distributor

Click to View Pricing, Inventory, Delivery & Lifecycle Information:

[TE Connectivity:](#)

[1-2342083-7](#)