

THIS DRAWING IS UNPUBLISHED. RELEASED FOR PUBLICATION 20
 © COPYRIGHT 20 BY - ALL RIGHTS RESERVED.

REVISIONS					
P	LTR	DESCRIPTION	DATE	DWN	APVD
A		RELEASE GOLD PLATED VERSIONS TO PRODUCTION	03SEP2019	AY	PS
A1		RELEASE TIN PLATED VERSIONS TO PRODUCTION	14APR2020	AY	PS

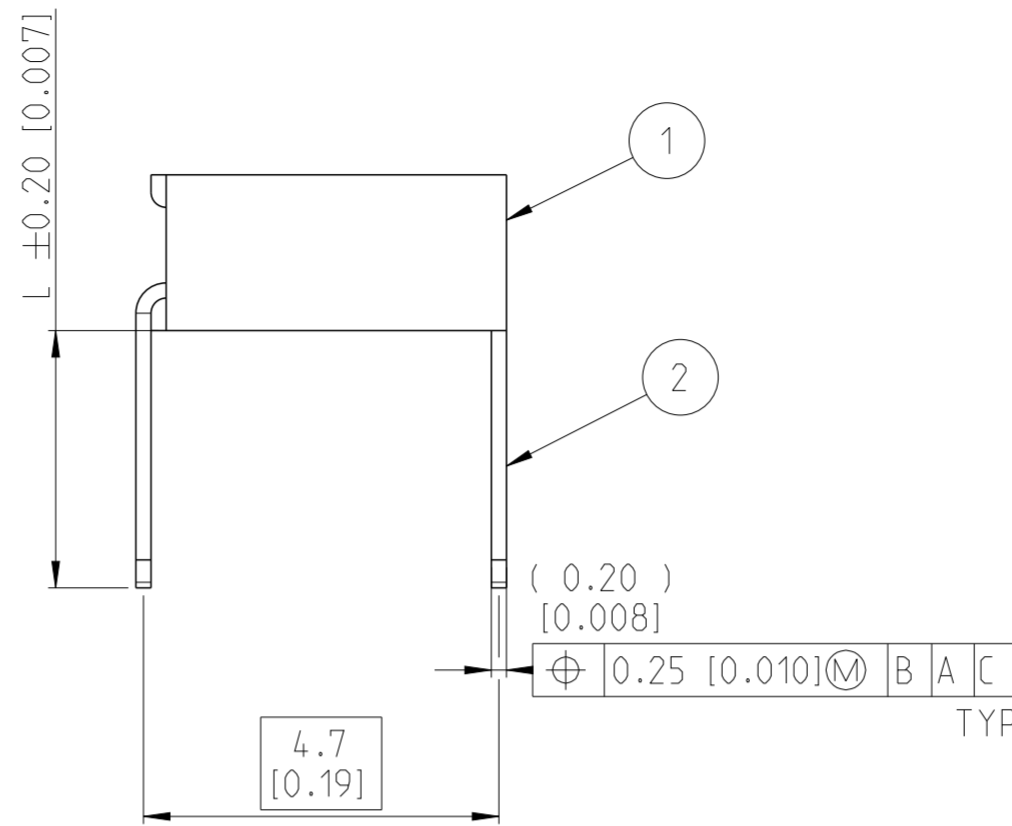
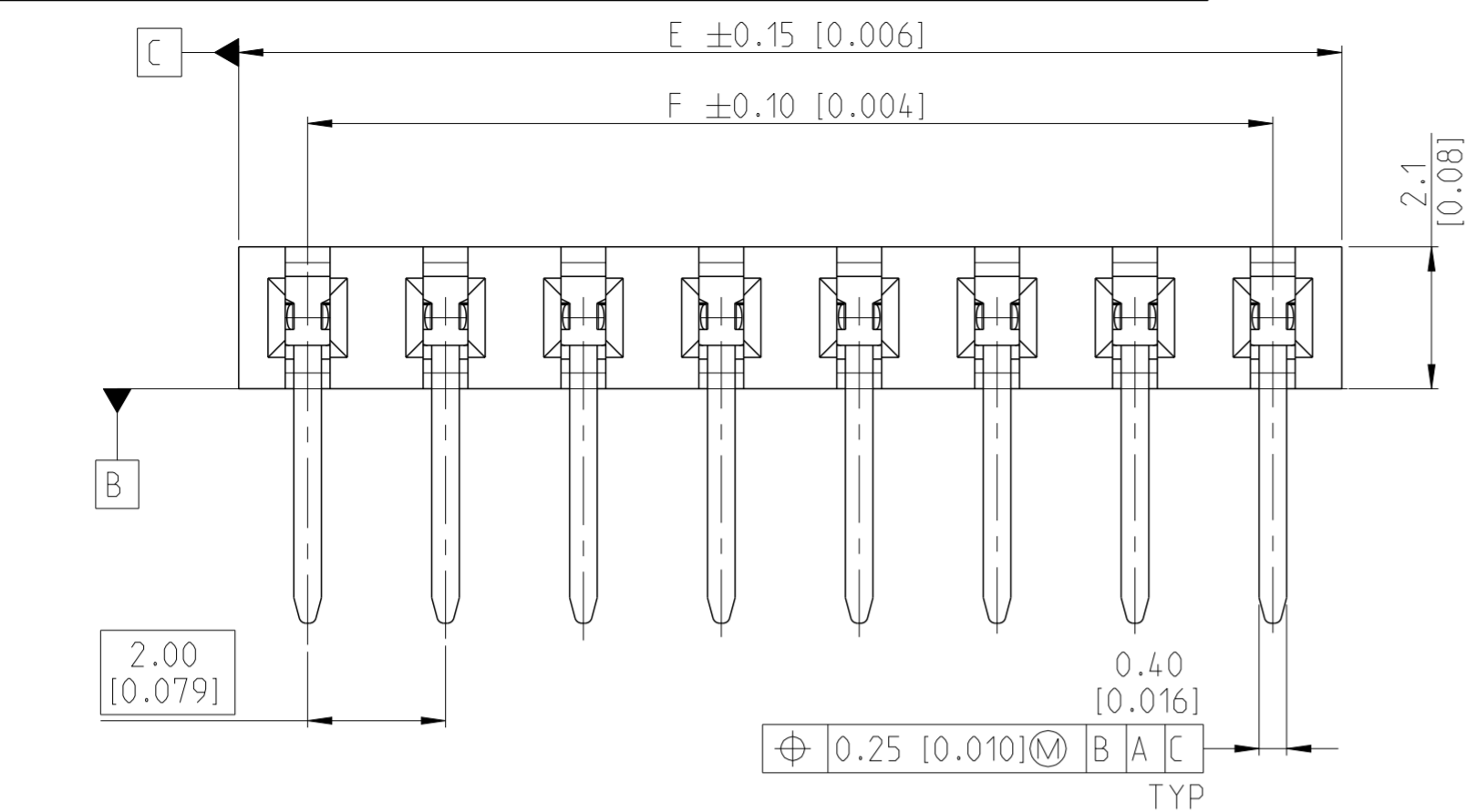

- NOTES:
- 1 MATERIAL:
HOUSING: LCP, UL94 V0, BLACK
CONTACT: PHOSPHOR BRONZE, 0.20mm THICK.
 - 2 ALL OVER 3-5µm TIN OVER MIN 1.27µm NICKEL UNDERPLATE
 - 3 CONTACT AREA: MIN 0.1µm GOLD
SOLDER TAIL: 3-5µm TIN
UNDERPLATING: MIN 1.27µm NICKEL ALL OVER
 - 4 CONTACT AREA: MIN 0.38µm GOLD
SOLDER TAIL: 3-5µm TIN
UNDERPLATING: MIN 1.27µm NICKEL ALL OVER
 - 5 CONTACT AREA: MIN 0.76µm GOLD
SOLDER TAIL: 3-5µm TIN
UNDERPLATING: MIN 1.27µm NICKEL ALL OVER
 - 6 N = NO. OF POSITIONS PER CONNECTOR.

CONTACT	2
HOUSING	1
DESCRIPTION	ITEM

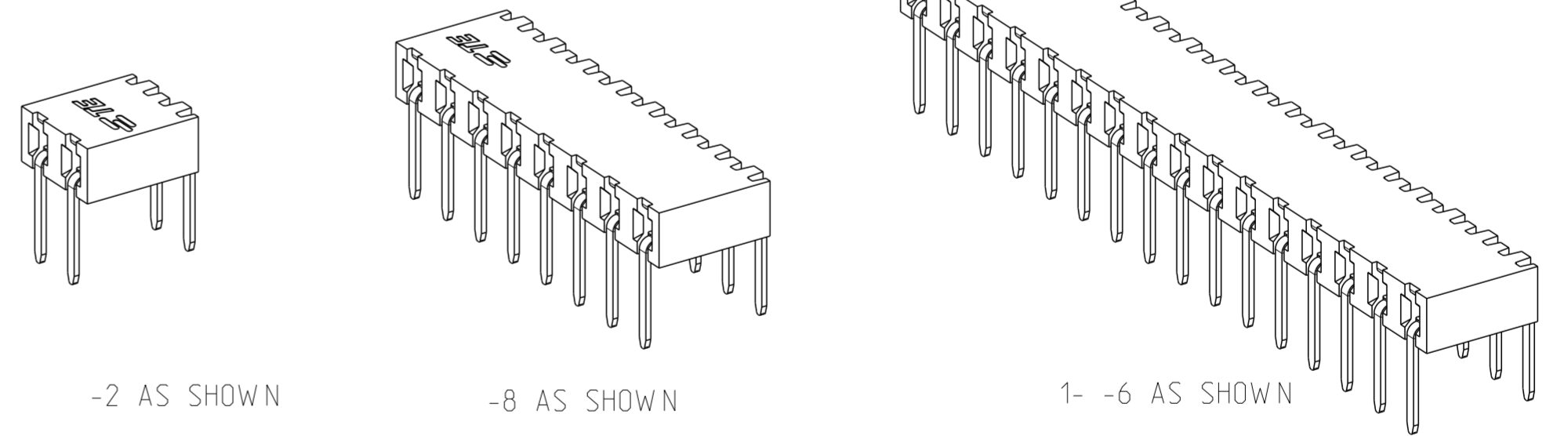
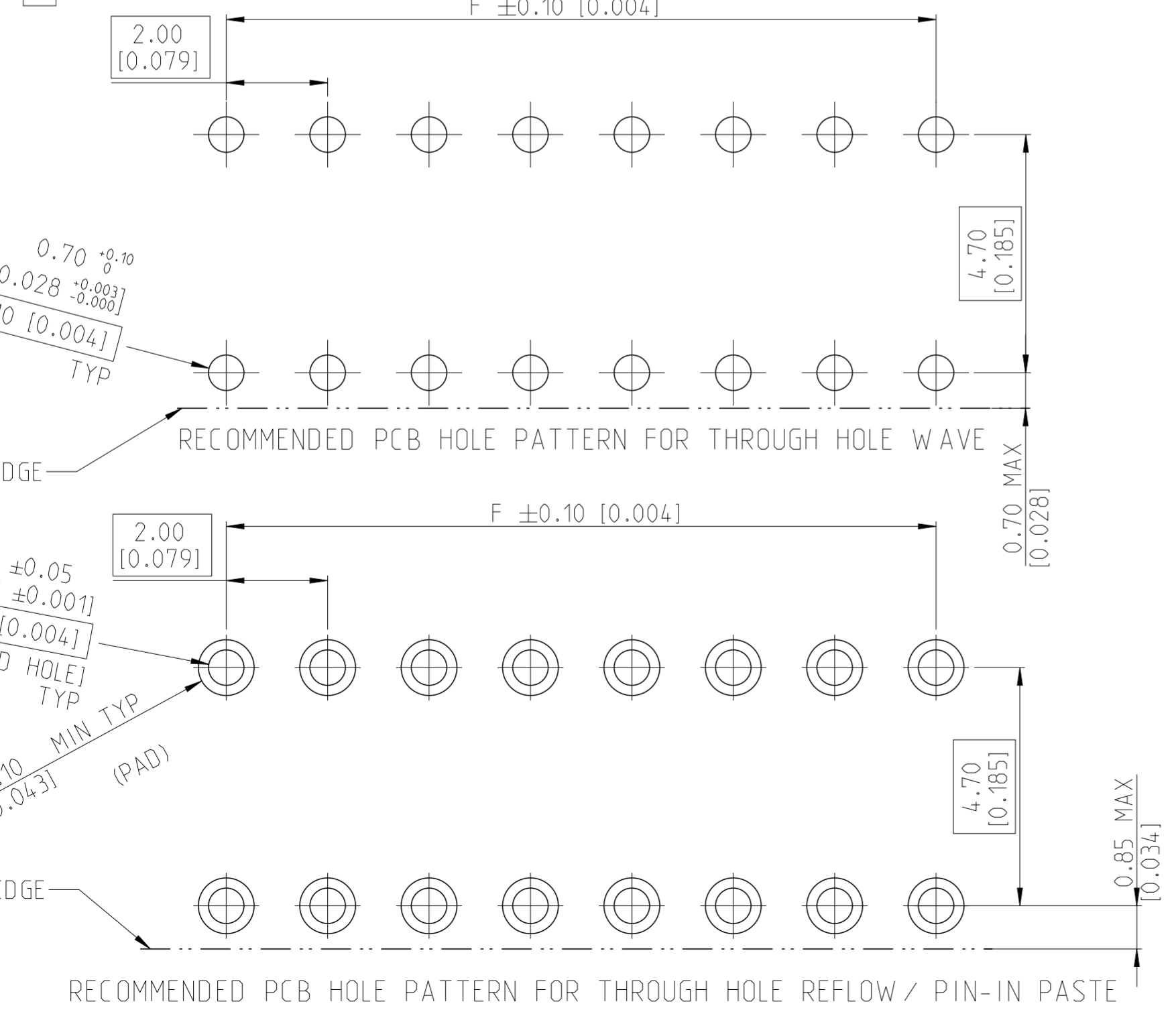
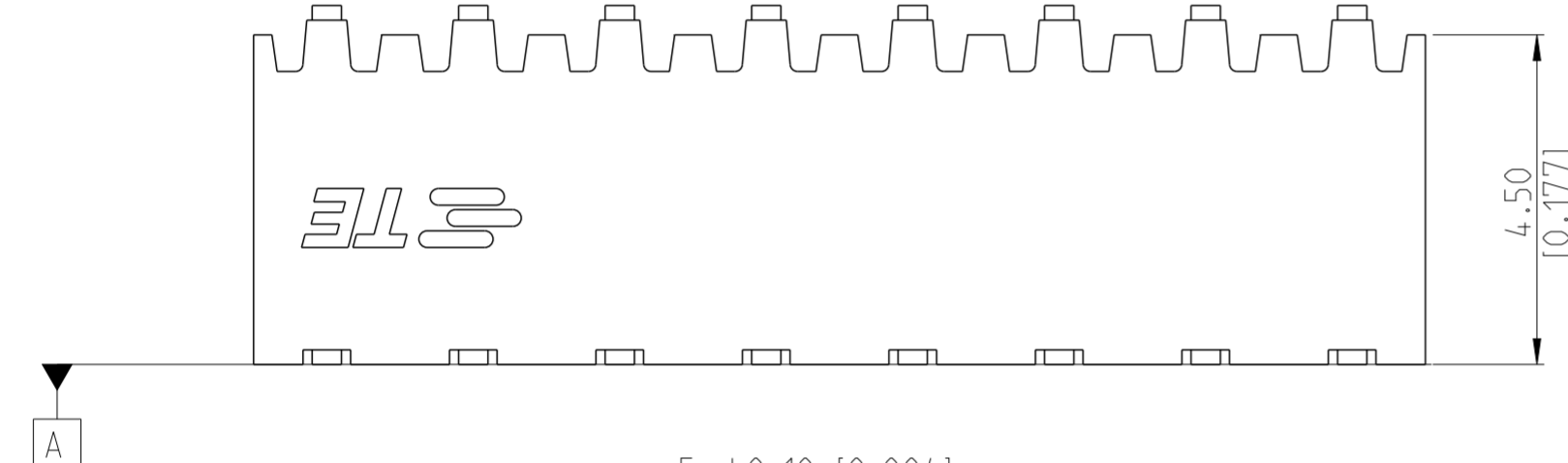

THIS DRAWING IS A CONTROLLED DOCUMENT.		DWN 23NOV2017 SOURAV DAS	TE Connectivity	
DIMENSIONS: mm [inch]		CHK 19JULY2018 SHARATH S		
TOLERANCES UNLESS OTHERWISE SPECIFIED:		APVD 19JULY2018 PRASHANTH S	NAME AMPMODU 2mm, BiB RECEPTACLE, SINGLE ROW, HORIZONTAL TH/THR	
0 PLC ±		PRODUCT SPEC 108-64040	SIZE CAGE CODE DRAWING NO RESTRICTED TO	
1 PLC ±0.2		APPLICATION SPEC 114-32186	A2 00779 C-2307700	
2 PLC ±0.1 [0.008]		WEIGHT -	SCALE 10:1 SHEET 1 OF 2 REV A1	
3 PLC ± [0.004]		CUSTOMER DRAWING		
4 PLC ±				
ANGLES ±2°				
FINISH SEE NOTES				

THIS DRAWING IS UNPUBLISHED. RELEASED FOR PUBLICATION 20
 © COPYRIGHT 20 BY - ALL RIGHTS RESERVED.

REVISIONS				
P	LTR	DESCRIPTION	DATE	APVD
-		SEE SHEET 1	-	-

MATING SIDE PLATING (FINISH)	"L" SOLDER TAIL LENGTH	BTB RECEPTACLE BASE NUMBERS	
		TAPE & REEL PKG W/O CAP	TUBE PKG W/O CAP
TIN △ 2	2.1[0.083]	2307700	2314927
	2.8[0.110]	2314935	2307701
	3.4[0.134]	A/R	2307702
GOLD FLASH 0.1 μm △ 3	2.1[0.083]	2307703	2314928
	2.8[0.110]	2314936	2307704
	3.4[0.134]	A/R	2307705
GOLD 0.38 μm △ 4	2.1[0.083]	2307706	2314929
	2.8[0.110]	2314937	2307707
	3.4[0.134]	A/R	2307708
GOLD 0.76 μm △ 5	2.1[0.083]	2307709	2314930
	2.8[0.110]	2314938	2307710
	3.4[0.134]	A/R	2307711

* A/R- AVAILABLE ON REQUEST

48	50	25	2- -5
46	48	24	2- -4
44	46	23	2- -3
42	44	22	2- -2
40	42	21	2- -1
38	40	20	2- -0
36	38	19	1- -9
34	36	18	1- -8
32	34	17	1- -7
30	32	16	1- -6
28	30	15	1- -5
26	28	14	1- -4
24	26	13	1- -3
22	24	12	1- -2
20	22	11	1- -1
18	20	10	1- -0
16	18	9	-9
14	16	8	-8
12	14	7	-7
10	12	6	-6
8	10	5	-5
6	8	4	-4
4	6	3	-3
2	4	2	-2
DIM "F"	DIM "E"	N	FG PN

THIS DRAWING IS A CONTROLLED DOCUMENT.		DWN 23NOV2017 SOURAV DAS	STE TE Connectivity	
DIMENSIONS: mm [inch]		CHK 19JULY2018 SHARATH S		
TOLERANCES UNLESS OTHERWISE SPECIFIED:		APVD 19JULY2018 PRASHANTH S	NAME AMPMODU 2mm, BtB RECEPTACLE, SINGLE ROW, HORIZONTAL TH/TR	
0 PLC ±		PRODUCT SPEC 108-64040	SIZE CAGE CODE DRAWING NO RESTRICTED TO	
1 PLC ±0.2		APPLICATION SPEC 114-32186	A2 00779 C-2307700	
2 PLC ±0.1 [0.008]		WEIGHT -	SCALE 10:1 SHEET 2 OF 2 REV A1	
3 PLC ± [0.004]		CUSTOMER DRAWING		
4 PLC ±				
ANGLES ±2°				
FINISH				
MATERIAL SEE NOTES				
SEE NOTES				

Mouser Electronics

Authorized Distributor

Click to View Pricing, Inventory, Delivery & Lifecycle Information:

[TE Connectivity:](#)

[2314938-6](#)