

THIS DRAWING IS UNPUBLISHED. RELEASED FOR PUBLICATION
 © COPYRIGHT - BY TYCO ELECTRONICS CORPORATION. ALL RIGHTS RESERVED.

LOC	DIST	REVISIONS					
		P	LTR	DESCRIPTION	DATE	DWN	APVD
H	-		A	RELEASED FOR PRODUCTION	24OCT2016	RK	MvE
			A1	CHANGED LASER MARKING	03NOV2016	RK	MvE
			A2	CHANGED LASER MARKING	07MAR2017	RK	MvE
			B	ECR-17-008373	16OCT2017	RK	PO

DIMENSIONS BEFORE APPLICATION

NOTES:

- 2213600-1 AS SHOWN.
- MATERIALS:

CONTACT: PHOSPHOR BRONZE, TIN PLATED
 HOUSING: PC NOT GLASS FILLED
 BUTTONS: PC NOT GLASS FILLED

3 LASER MARKING:

- KEMA
- UL
- TE LOGO
- TE PART NUMBER
- DATE CODE

4 LASER MARKING: IP20

5 LASER MARKING: IP x5/x7

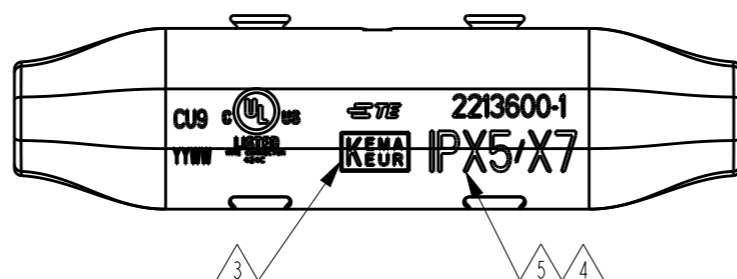
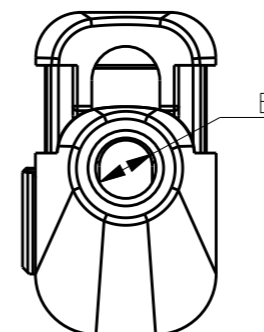
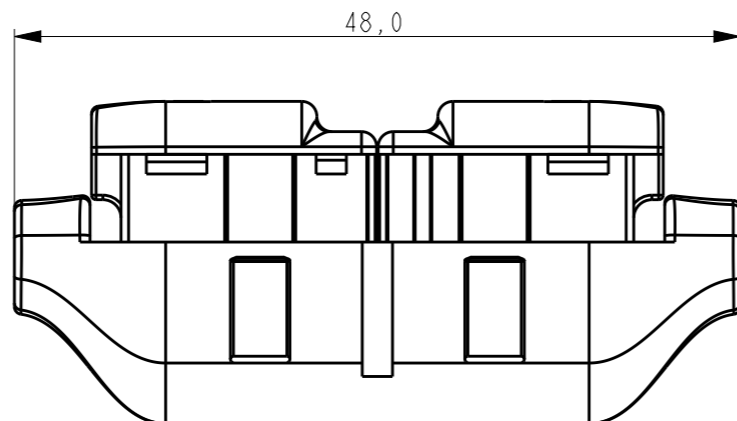
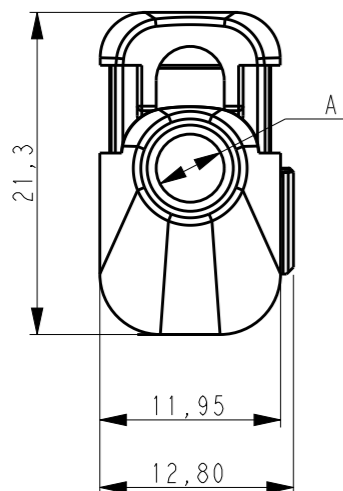
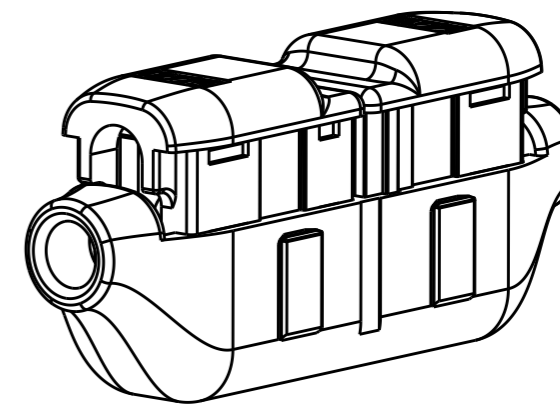
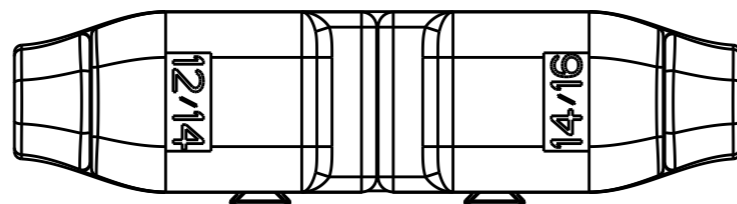

STANDARD	4	A=3.5 B=3.5	16/18 TO 16/18	RED AND RED	CLEAR	1-2213600-0
STANDARD	4	A=4.5 B=4.5	12/14 TO 12/14	YELLOW AND YELLOW	CLEAR	2213600-9
SEALED	5	A=3.5 B=3.5	16/18 TO 16/18	RED AND RED	CLEAR	2213600-8
SEALED	5	A=4.5 B=4.5	12/14 TO 12/14	YELLOW AND YELLOW	CLEAR	2213600-7
STANDARD	4	A=4.0 B=3.5	14/16 TO 16/18	BLUE AND RED	CLEAR	2213600-6
STANDARD	4	A=4.5 B=3.5	12/14 TO 16/18	YELLOW AND RED	CLEAR	2213600-5
STANDARD	4	A=4.5 B=4.0	12/14 TO 14/16	YELLOW AND BLUE	CLEAR	2213600-4
SEALED	5	A=4.0 B=3.5	14/16 TO 16/18	BLUE AND RED	CLEAR	2213600-3
SEALED	5	A=4.5 B=3.5	12/14 TO 16/18	YELLOW AND RED	CLEAR	2213600-2
SEALED	5	A=4.5 B=4.0	12/14 TO 14/16	YELLOW AND BLUE	CLEAR	2213600-1
SEALING		WIRE ENTRY	WIRE SIZE	BUTTON COLORS	HOUSING COLOR	PART NUMBER

THIS DRAWING IS A CONTROLLED DOCUMENT. DIMENSIONING AND TOLERANCING PER ASME Y14.5M-2009.		DWN M.V.ESSEN 06 NOV '15	 TE Connectivity	
DIMENSIONS: mm		CHK C.V.STEENDEREN		
TOLERANCES UNLESS OTHERWISE SPECIFIED:		APVD O.I.FIJNSE	NAME COOL SPLICE ONE POSITION LARGE WIRE GAUGE	
0 PLC ±-		PRODUCT SPEC 108-133061	RESTRICTED TO	
1 PLC ±0,2		APPLICATION SPEC 114-133061	SIZE A3	CAGE CODE 00779
2 PLC ±0,2		WEIGHT -	DRAWING NO C-2213600	SCALE 2:1
3 PLC ±-		CUSTOMER DRAWING	SHEET 1	OF 3
4 PLC ±-			REV C2	
ANGLES ±-				
FINISH -				

THIS DRAWING IS UNPUBLISHED.

RELEASED FOR PUBLICATION



© COPYRIGHT - BY TYCO ELECTRONICS CORPORATION. ALL RIGHTS RESERVED.

LOC	DIST	REVISIONS					
		P	LTR	DESCRIPTION	DATE	DWN	APVD
		-		SEE SHEET 1	-	-	-

DIMENSIONS AFTER APPLICATION

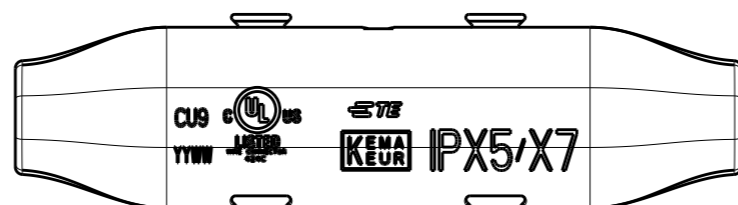
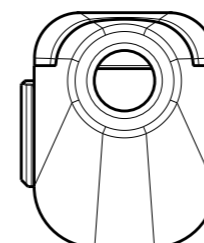
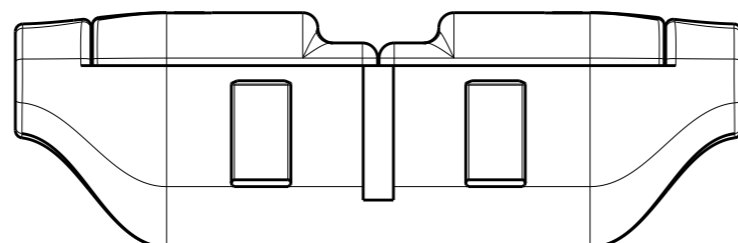
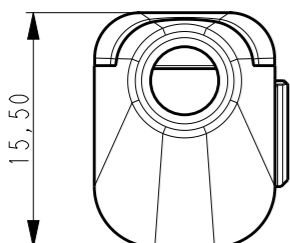
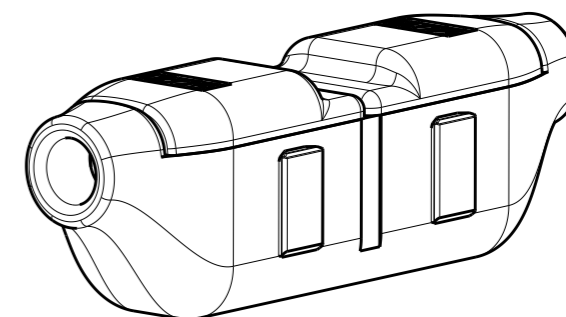
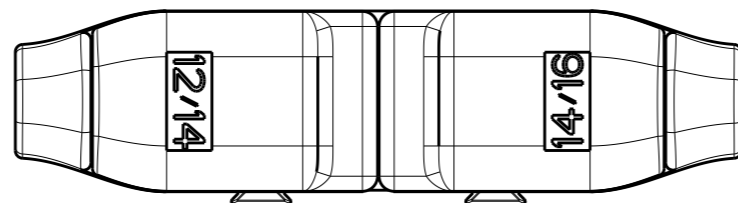
NOTE:
1. 2213600-1 AS SHOWN.



THIS DRAWING IS A CONTROLLED DOCUMENT.		DWN M.V.ESSSEN	06 NOV'15	 TE Connectivity	
DIMENSIONS: mm		CHK C.V.STEENDEREN	-		
		APVD O.I.FIJNSE	-	NAME COOL SPLICE ONE POSITION LARGE WIRE GAUGE	
TOLERANCES UNLESS OTHERWISE SPECIFIED:		PRODUCT SPEC	108-133061	SIZE A3	
0 PLC ±-		APPLICATION SPEC	114-133061	CAGE CODE	00779
1 PLC ±0,2		WEIGHT	-	DRAWING NO	C-2213600
2 PLC ±0,2		CUSTOMER DRAWING		RESTRICTED TO	-
3 PLC ±-		SCALE 1:1		SHEET 2 OF 3	REV C2
4 PLC ±-					
ANGLES ±-					
FINISH					
MATERIAL					

THIS DRAWING IS UNPUBLISHED.

RELEASED FOR PUBLICATION

© COPYRIGHT - BY TYCO ELECTRONICS CORPORATION. ALL RIGHTS RESERVED.

LOC DIST

REVISIONS

P	LTR	DESCRIPTION	DATE	DWN	APVD
-	-	SEE SHEET 1	-	-	-

DIMENSIONS AFTER STACKING

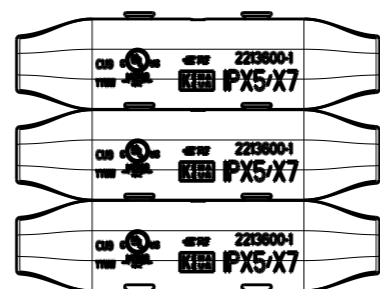
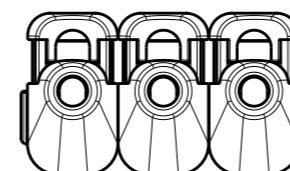
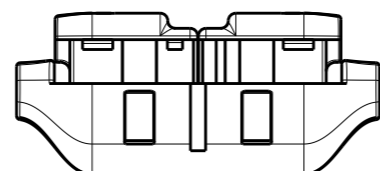
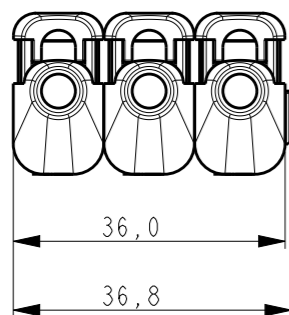
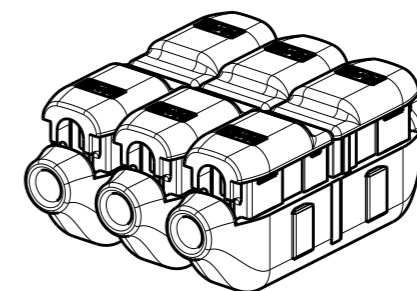
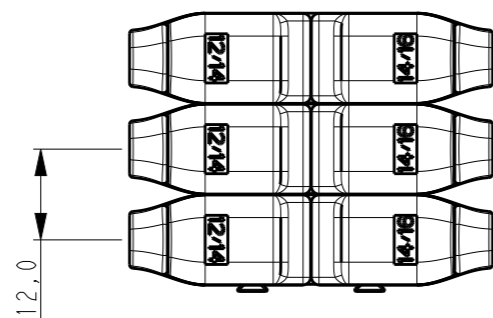

THIS DRAWING IS A CONTROLLED DOCUMENT.

DIMENSIONS:
mm

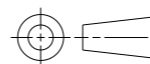

TOLERANCES UNLESS OTHERWISE SPECIFIED:

0 PLC	±-
1 PLC	±0,2
2 PLC	±0,2
3 PLC	±-
4 PLC	±-
ANGLES	±-

MATERIAL

FINISH

DWN 06 NOV '15

M.V.ESSEN

CHK

C.V.STEENDEREN

APVD

O.I.FIJNSE

PRODUCT SPEC

108-133061

APPLICATION SPEC

114-133061

WEIGHT

-

CUSTOMER DRAWING



TE Connectivity

NAME
COOL SPLICE
ONE POSITION LARGE WIRE GAUGE

SIZE	CAGE CODE	DRAWING NO	RESTRICTED TO
------	-----------	------------	---------------

A3	00779	C-2213600	-
----	-------	-----------	---

SCALE	SHEET	OF	REV
1:1	3	3	C2

Mouser Electronics

Authorized Distributor

Click to View Pricing, Inventory, Delivery & Lifecycle Information:

[TE Connectivity:](#)

[2213600-7](#)