

THIS DRAWING IS UNPUBLISHED.

RELEASED FOR PUBLICATION

2011

© COPYRIGHT 2011

ALL RIGHTS RESERVED.

LOC  
AI

DIST  
-

REVISIONS

P	LTR	DESCRIPTION	DATE	DWN	APVD
	A	REVISED PER ECO-12-002880	15FEB12	KH	MS

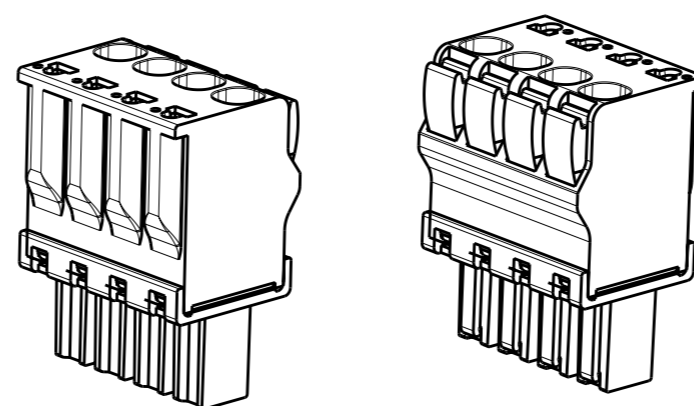
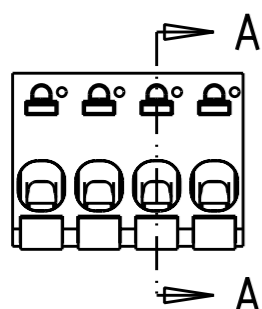
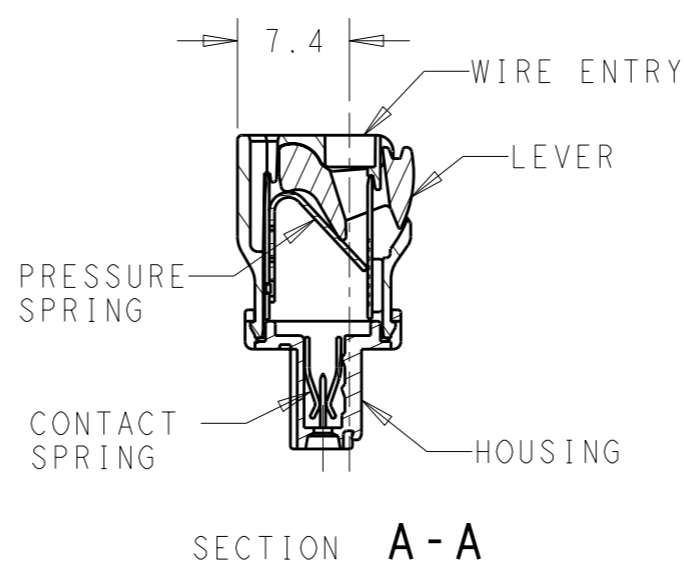
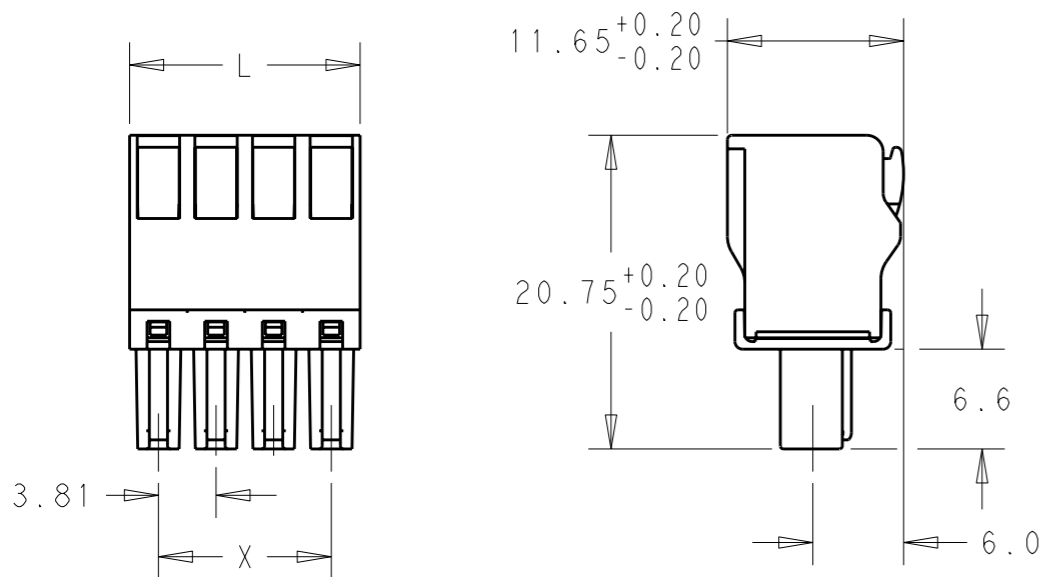

91.44	95.25	25	2-1986720-5
87.63	91.44	24	2-1986720-4
83.82	87.63	23	2-1986720-3
80.01	83.82	22	2-1986720-2
76.20	80.01	21	2-1986720-1
72.39	76.20	20	2-1986720-0
68.58	72.39	19	1-1986720-9
64.77	68.58	18	1-1986720-8
60.96	64.77	17	1-1986720-7
57.15	60.96	16	1-1986720-6
53.34	57.15	15	1-1986720-5
49.53	53.34	14	1-1986720-4
45.72	49.53	13	1-1986720-3
41.91	45.72	12	1-1986720-2
38.10	41.91	11	1-1986720-1
34.29	38.10	10	1-1986720-0
30.48	34.29	9	1986720-9
26.67	30.48	8	1986720-8
22.86	26.67	7	1986720-7
19.05	22.86	6	1986720-6
15.24	19.05	5	1986720-5
11.43	15.24	4	1986720-4
7.62	11.43	3	1986720-3
3.81	7.62	2	1986720-2
DIM X	DIM L	POLE	PART NUMBER

**MATERIALS**  
 HOUSING-POLYAMIDE, COLOR-GREEN  
 LEVER-POLYAMIDE, COLOR ORANGE  
 CONTACT SPRING-COPPER ALLOY-LEAD FREE TIN PLATED  
 CLAMPING SPRING-STEEL

**MECHANICAL**  
 INSERTION FORCE PER POLE- 3 NEWTON MAX  
 WITHDRAWAL FORCE PER POLE- 1.5 NEWTON MIN  
 STRIPPING LENGTH- 10.5 TO 11.5 MM  
 OPERATING TEMPERATURE--40°C TO +110°C

**ELECTRICAL**  
 WIRE SIZE= 30 TO 14 AWG SOLID OR STRANDED  
 VOLTAGE RATING- 300 VOLTS  
 CURRENT RATING- 11 AMP STRANDED; 9AMP SOLID  
 CONTACT RESISTANCE-15 MILLOHM MAX  
 INSULATION RESISTANCE-10<sup>9</sup> OHMS MIN (500V DC)

THIS DRAWING IS A CONTROLLED DOCUMENT.		DWN 16 JAN 2012 KIRAN HOLAL	TE Connectivity	
DIMENSIONS: mm		CHK 16 JAN 2012 MIKE SARVER		
TOLERANCES UNLESS OTHERWISE SPECIFIED:		APVD 16 JAN 2012 MIKE SARVER	NAME STRAIGHT SPRING TYPE PLUG CONNECTOR, SIDE STACKABLE RIGHT 02 - 25 POLES PITCH 3.81mm	
0 PLC ±- 1 PLC ±0.40 2 PLC ±0.20 3 PLC ±- 4 PLC ±- ANGLES ±-		PRODUCT SPEC -	SIZE CAGE CODE DRAWING NO RESTRICTED TO A300779 C-1986720	
MATERIAL - FINISH -		APPLICATION SPEC -	SCALE 2:1 SHEET 1 OF 1 REV A	
CUSTOMER DRAWING		WEIGHT -		

# Mouser Electronics

Authorized Distributor

Click to View Pricing, Inventory, Delivery & Lifecycle Information:

[TE Connectivity:](#)

[1-1986720-4](#)