

REVISIONS					
P	LTR	DESCRIPTION	DATE	DWN	APVD
	10	INITIAL RELEASE	11FEB2020	GK	AK

NOTES: -

1. CHARACTERS: -

0-9, A-Z, +, -, /, ~, ≡

0, 1, 6 & 9 FOLLOWED BY A FULL STOP.

HEIGHT 2.6 - 2.9 mm

TOLERANCE (AXIAL) ±0.75

(ROTATIONAL) ±5°

CHEVRON CUT MARKERS: -

CHARACTERS TO BE CENTRALLY DISPOSED ON MARKER FACE AND IN THE ATTITUDE SHOWN RELATIVE TO CHEVRON.

2. MARKER LENGTHS (DIMENSION 'A'):-

WITH SINGLE MARK 4.00-4.75

WITH DOUBLE MARK 6.75-7.25

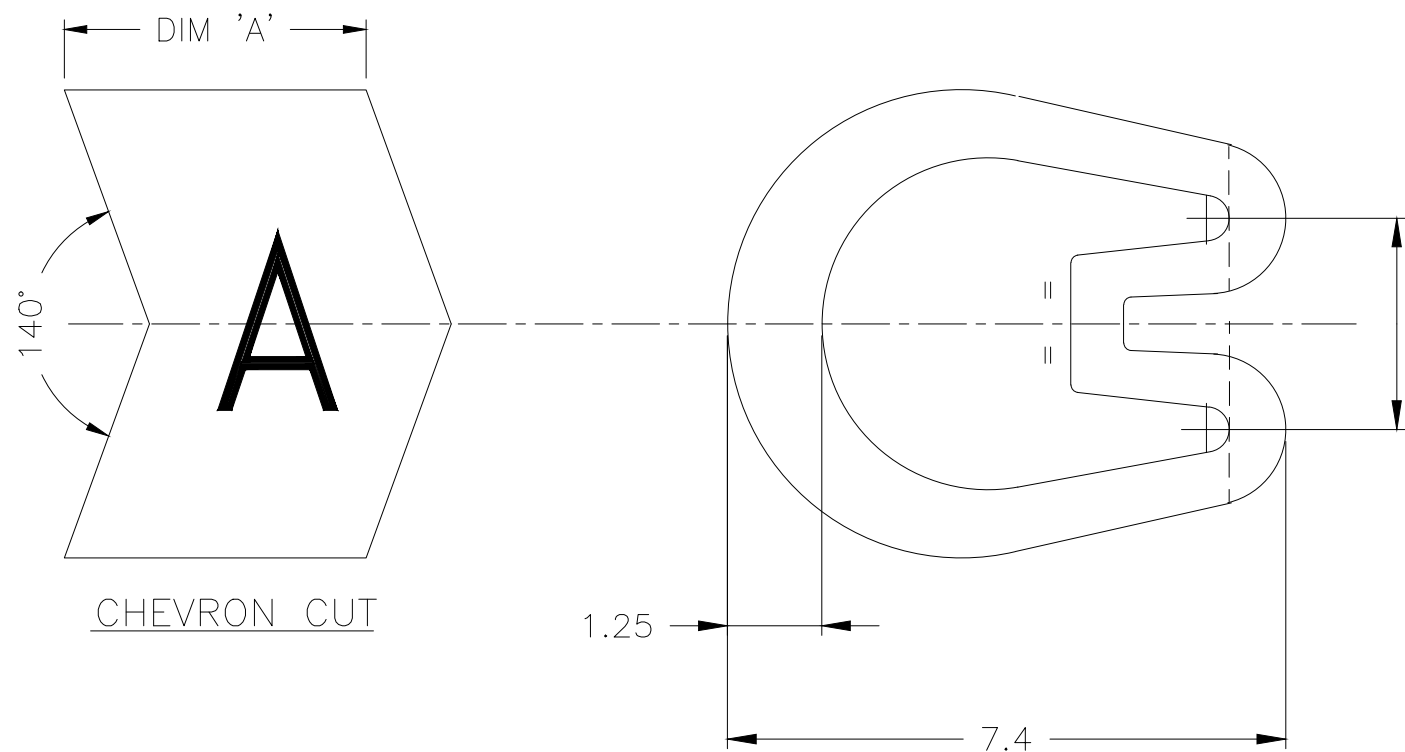

CHEVRON CUT

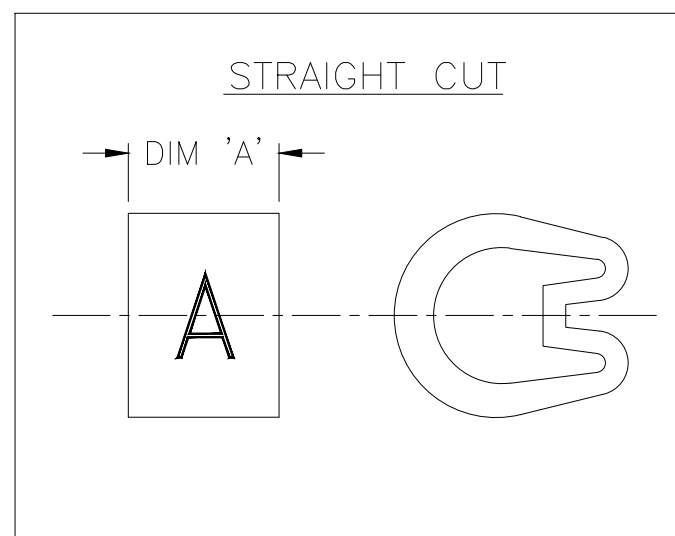

STRAIGHT CUT

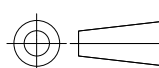
THIS DRAWING IS A CONTROLLED DOCUMENT.		DWN GOPALAKRISHNA H V 11FEB2020	 TE Connectivity		
		CHK ALAN KEAN 11FEB2020			
DIMENSIONS: mm		APVD ALAN KEAN 11FEB2020	NAME MARKER Z TYPE SIZE 18 STRAIGHT / CHEVRON CUT		
		PRODUCT SPEC -	RESTRICTED TO -		
TOLERANCES UNLESS OTHERWISE SPECIFIED:		APPLICATION SPEC -	SIZE A3	CAGE CODE 00779	DRAWING NO C-1601A0007
MATERIAL PVC 6.12 - 5.54g/250mm		FINISH -	WEIGHT -	SCALE 10:1	SHEET 1 OF 1
CUSTOMER DRAWING			REV 10		

Mouser Electronics

Authorized Distributor

Click to View Pricing, Inventory, Delivery & Lifecycle Information:

[TE Connectivity:](#)

[EJ2204-000](#)