



5G/4G/3G/2G, NB-IoT, Cat-M, GNSS, Wi-Fi 6E WORLD BAND ANTENNA

**Part Numbers: 2195846-1, 2195846-2
2195846-3, 2195846-4
2195846-5, 2195846-6
2195846-7, 2195846-8**

FEATURES & BENEFITS

- Omnidirectional coverage
- Cabled FPC antenna
- Uses MetaSpan technology for World band coverage for 3G, 4G, 5G, NB-IoT and Cat-M
- Wi-Fi 6E triple band, Bluetooth, Zigbee and GNSS L1 included
- Adhesive backing on the FPC simplifies mounting within the device
- Different cable length and connector options available

SPECIFICATIONS (Shown as 2195846-4 : Others can vary with different cable lengths.)

Frequency Range (MHz)	698-960	1560-1630	1710-2700	3200-3800	4400-5000	5150-5875	5925-7125
VSWR	< 1.7 : 1	< 2.1 : 1	< 2.6 : 1	< 1.9 : 1	< 1.8 : 1	< 1.5 : 1	< 2.3 : 1
Average Efficiency	49%	54%	57%	71%	71%	72%	59%
Peak Gain	-1.7 dBi	4.0 dBi	3.2 dBi	3.7 dBi	4.7 dBi	4.2 dBi	6.7 dBi
Average Gain	-3.1 dBi	-2.7 dBi	-2.4 dBi	-1.5 dBi	-1.5 dBi	-1.4 dBi	-2.3 dBi
Power Handling	10 Watt cw						
Feed Point Impedance	50 ohms unbalanced						
Polarization	Linear						
Size	80.0 mm x 15.0 mm x 0.2 mm						
Weight	< 1.5 g						
Mounting	Adhesive Tape						
Mating Connector	MHF-type receptacle (TE PN: 2337019-1) MHF4-type receptacle (TE PN: 2344884-1)						
Cable	1.13 mm Dia. & 1.37 mm Dia.						
Operating Temperature	-40 to +85°C						
Storage Temperature	-40 to +85°C						
Hazardous Materials	A certificate of conformance is available from the product page on TE website.						

RF DATA (Shown as 2195846-4 : Others can vary with different cable lengths.)

VSWR

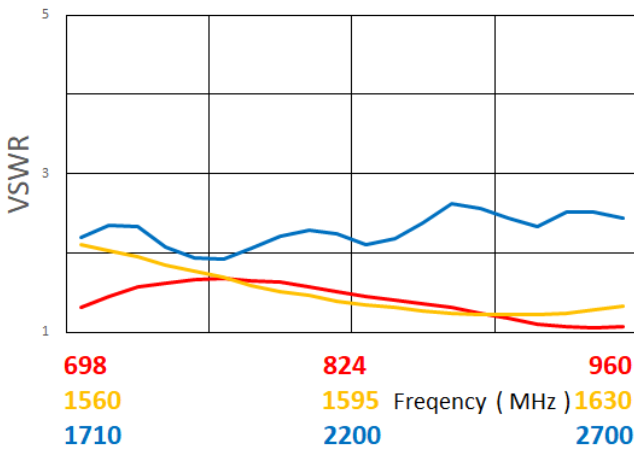

Return Loss

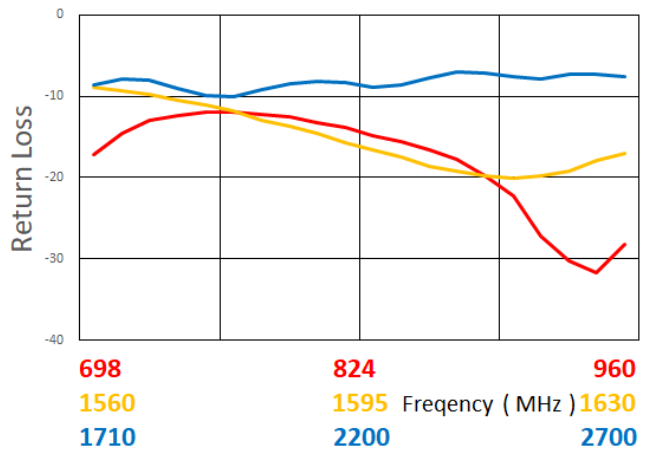

Efficiency

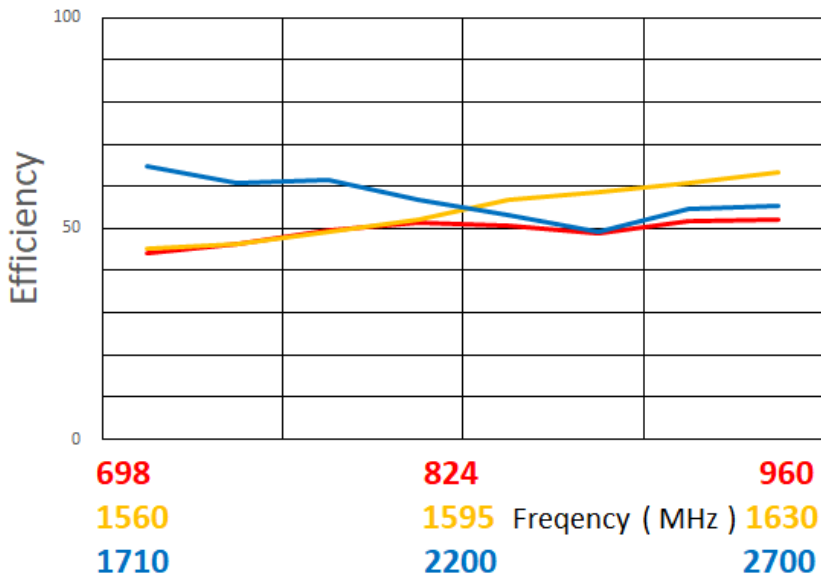

Data measured in free space and on plastic device enclosure

RF DATA (Shown as 2195846-4 : Others can vary with different cable lengths.)

VSWR

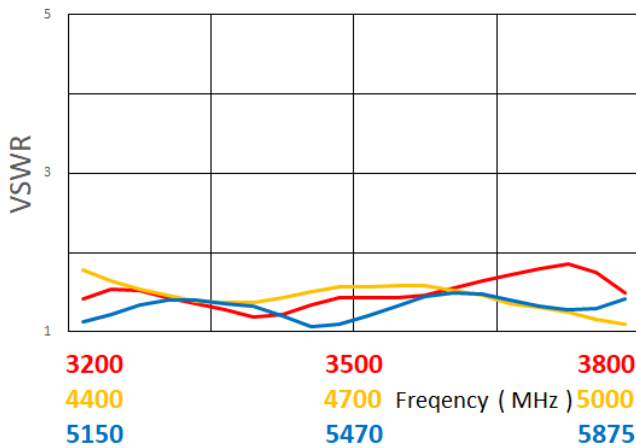

Return Loss

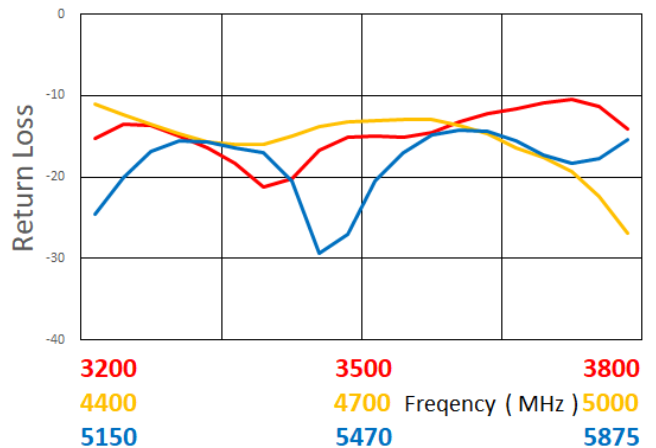

Efficiency

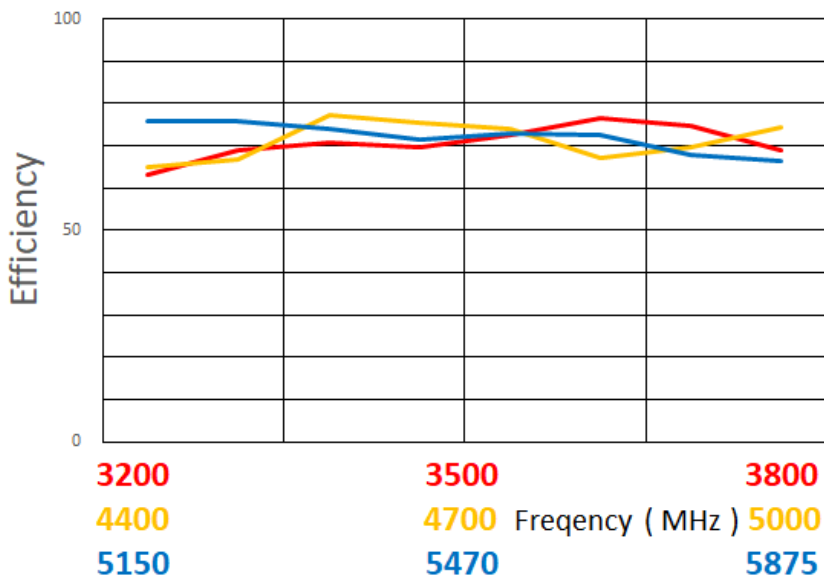

Data measured in free space and on plastic device enclosure

RF DATA (Shown as 2195846-4 : Others can vary with different cable lengths.)

VSWR

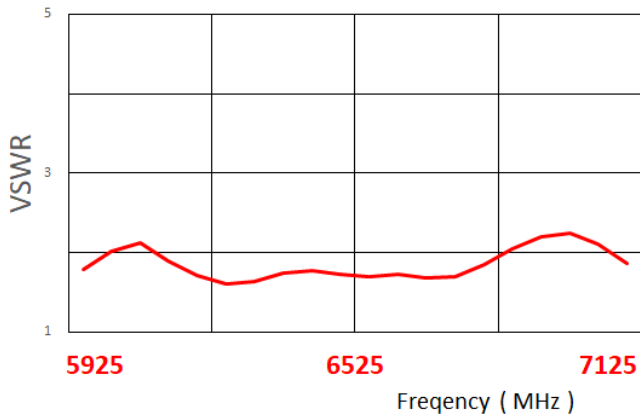

Return Loss

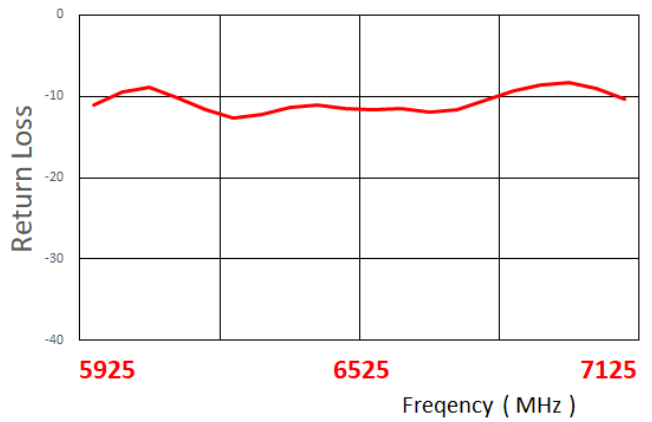

Efficiency

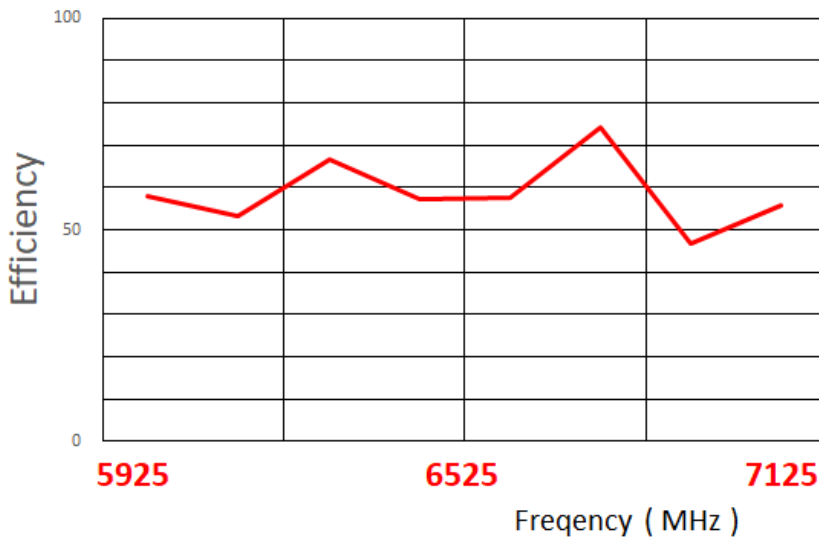

Data measured in free space and on plastic device enclosure

RADIATION PATTERN (Shown as 2195846-4 : Others can vary with different cable lengths)

Test setup

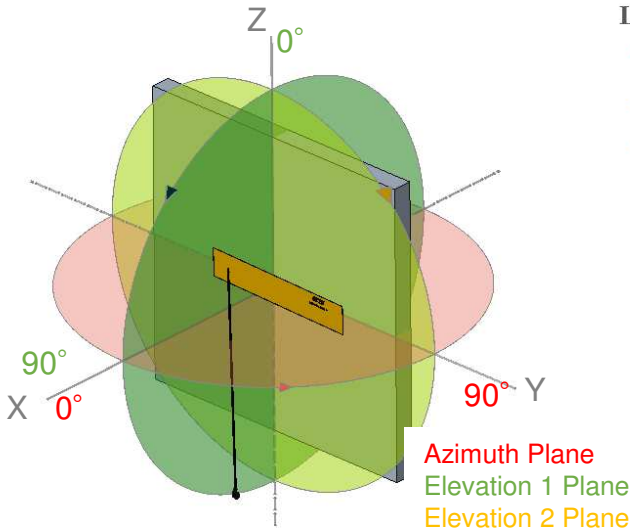

Azimuth

Legend :

- 824 MHz
- 1595 MHz
- 2200 MHz

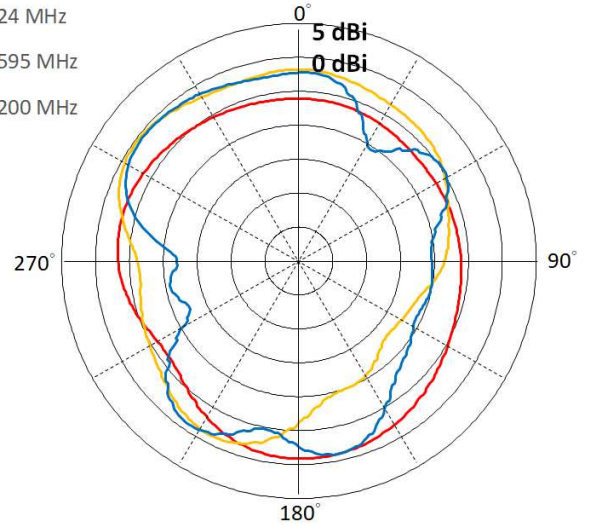

Elevation 1

Legend :

- 824 MHz
- 1595 MHz
- 2200 MHz

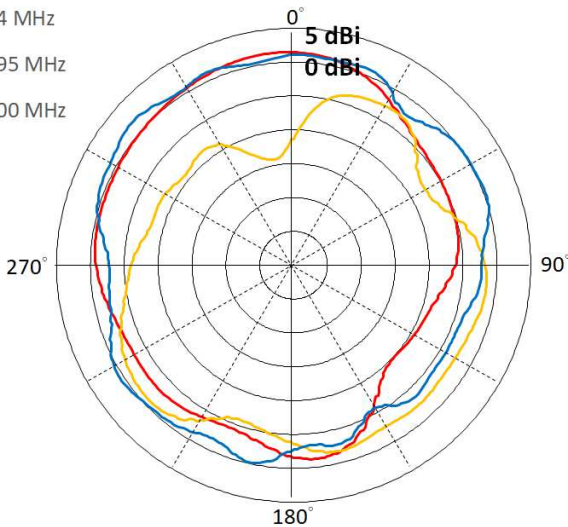

Elevation 2

Legend :

- 824 MHz
- 1595 MHz
- 2200 MHz

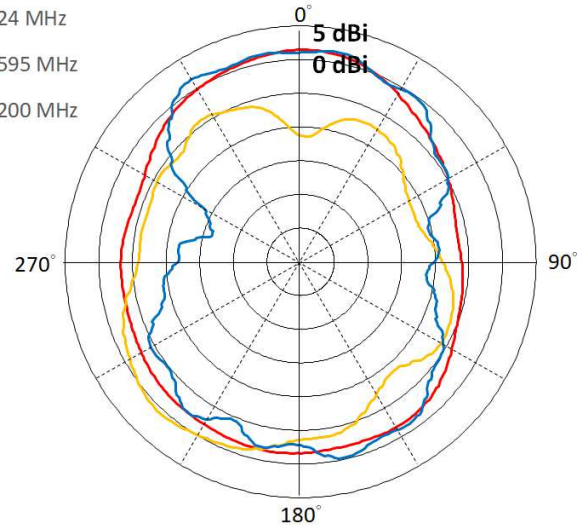

Data measured in free space and on plastic device enclosure

RADIATION PATTERN (Shown as 2195846-4 : Others can vary with different cable lengths)

Test setup

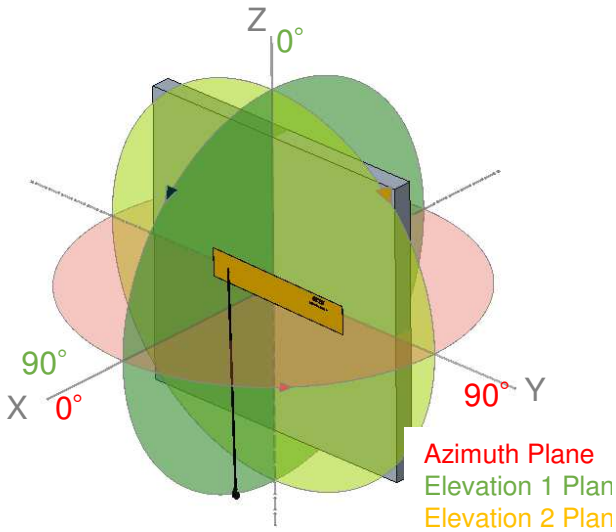

Azimuth

Legend :

- 3500 MHz
- 4700 MHz
- 5470 MHz

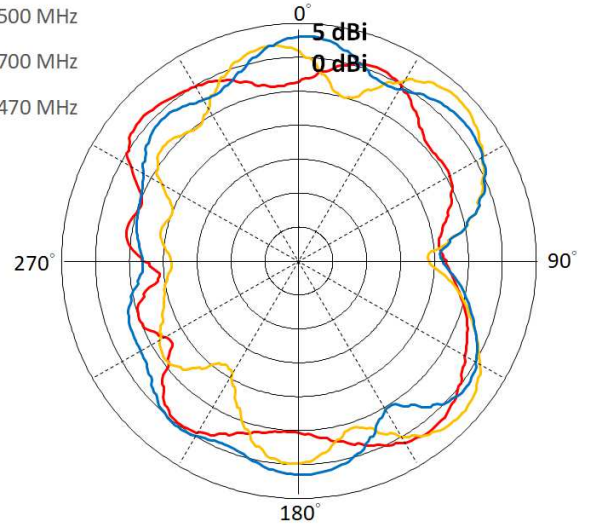

Elevation 1

Legend :

- 3500 MHz
- 4700 MHz
- 5470 MHz

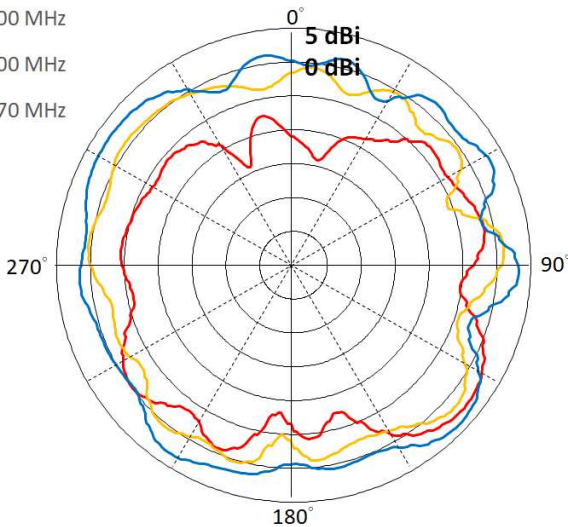

Elevation 2

Legend :

- 3500 MHz
- 4700 MHz
- 5470 MHz

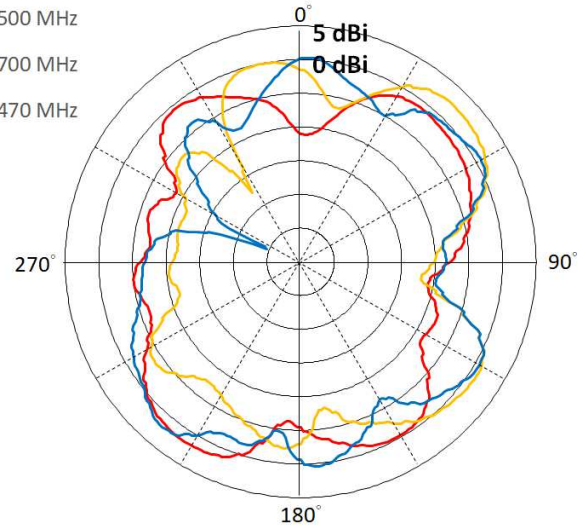

Data measured in free space and on plastic device enclosure

RADIATION PATTERN (Shown as 2195846-4 : Others can vary with different cable lengths)

Test setup

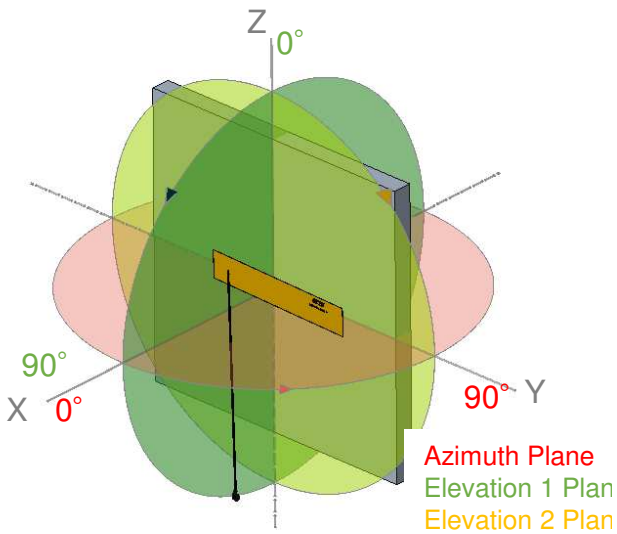

Azimuth

Legend :

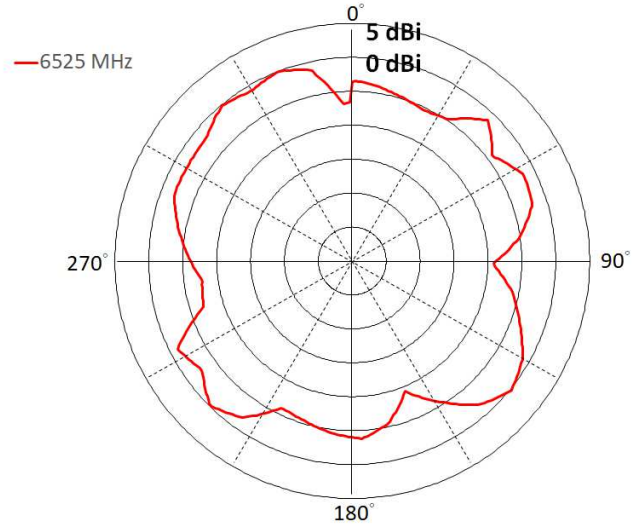

Elevation 1

Legend :

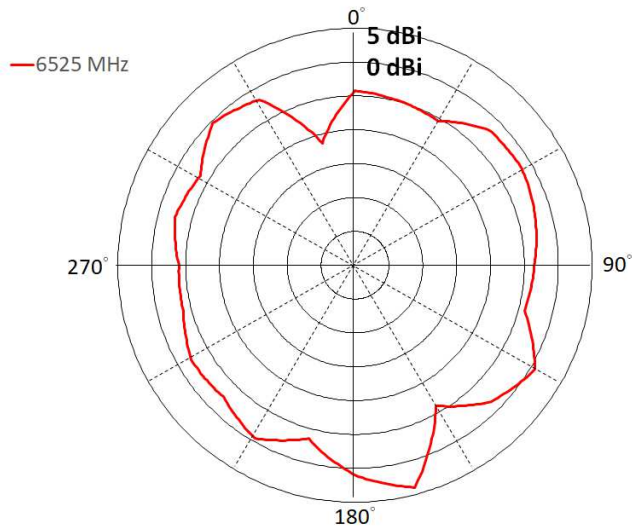

Elevation 2

Legend :

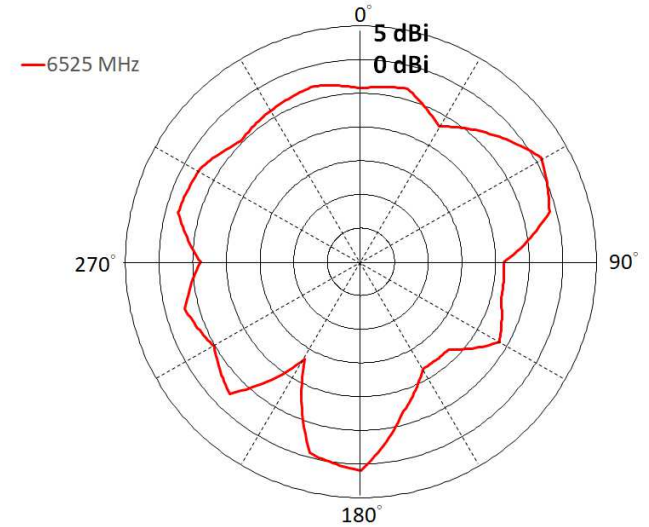

Data measured in free space and on plastic device enclosure

KEEP OUT AREA

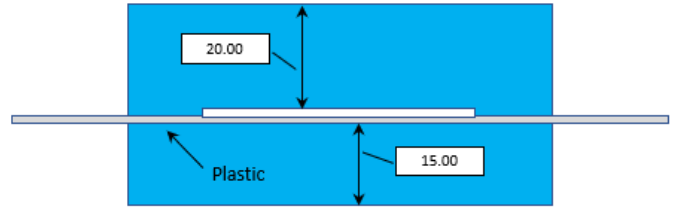
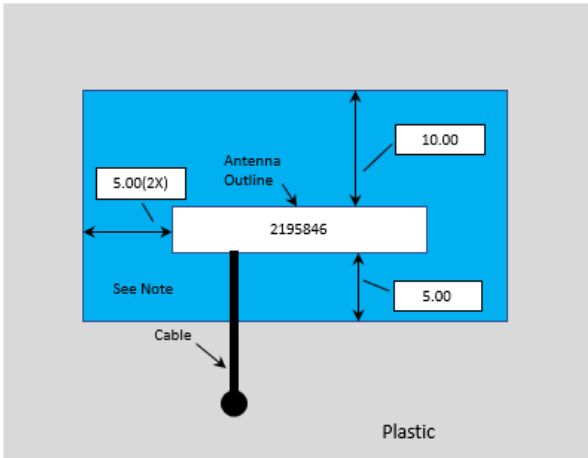



- NOTES :
1. Antenna designed to be mounted on plastic cover.
 2. Area in blue above indicates Keep Out Area. This is base on 60x60mm size metal parts.
 3. For more information please call TE.

Dimensions : mm
Diagram is not to scale

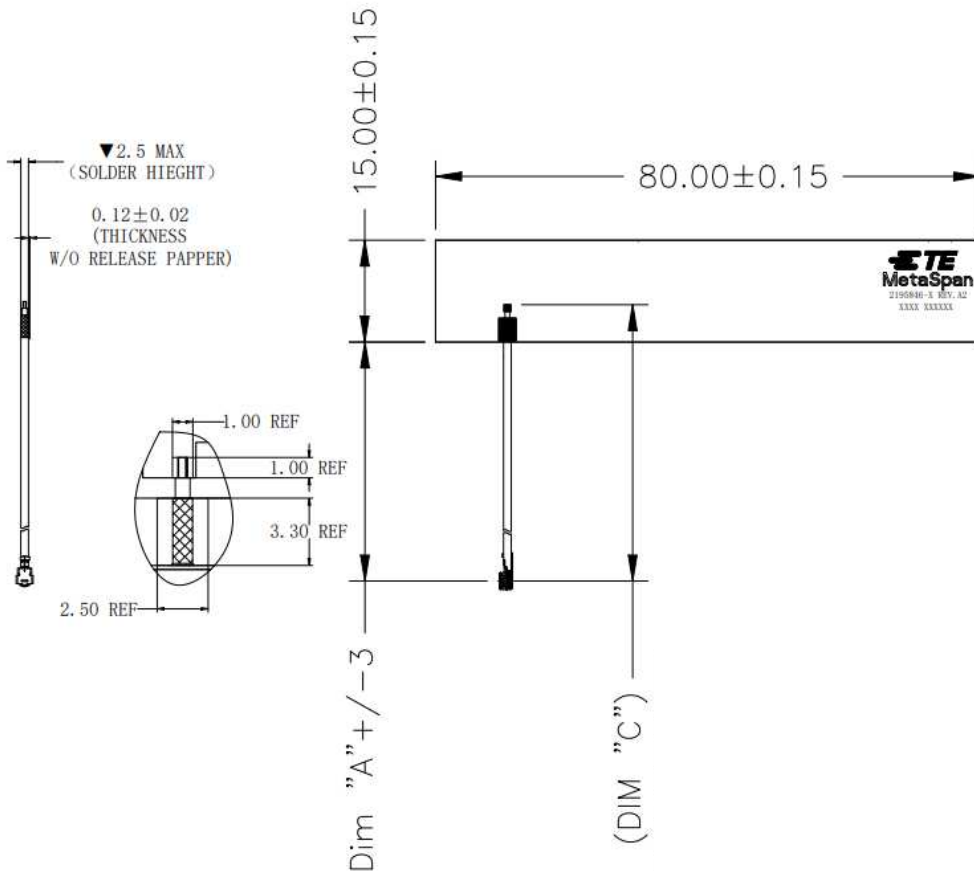
DIMENSIONS



MATING COMPONENTS

2195846-1	50.0	1.969	1.37	MHF-TYPE PLUG	RECEPTACLE (TE PN : 2337019-1)	
2195846-2	100.0	3.937	1.37	MHF-TYPE PLUG	RECEPTACLE (TE PN : 2337019-1)	
2195846-3	150.0	5.906	1.37	MHF-TYPE PLUG	RECEPTACLE (TE PN : 2337019-1)	
2195846-4	200.0	7.874	1.37	MHF-TYPE PLUG	RECEPTACLE (TE PN : 2337019-1)	
2195846-5	50.0	1.969	1.13	MHF4L-TYPE PLUG	RECEPTACLE (TE PN : 2334884-1)	
2195846-6	100.0	3.937	1.13	MHF4L-TYPE PLUG	RECEPTACLE (TE PN : 2334884-1)	
2195846-7	150.0	5.906	1.13	MHF4L-TYPE PLUG	RECEPTACLE (TE PN : 2334884-1)	
2195846-8	200.0	7.874	1.13	MHF4L-TYPE PLUG	RECEPTACLE (TE PN : 2334884-1)	
PART NUMBER	MM	INCH	MM	CONNECTOR TYPE (ON CABLE)	PART NUMBER	IMAGE
	CABLE LENGTH "A"		CABLE DIA.		MATING COMPONENTS	

PACKAGING

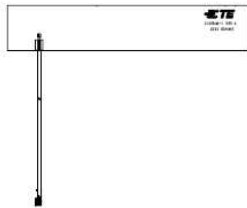

25 PCS/Bundle

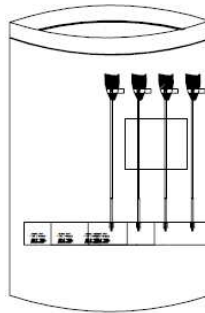

50pcs/Bag
drying agent:1pcs/Bag

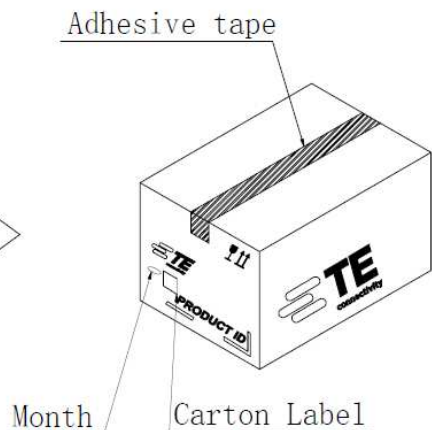
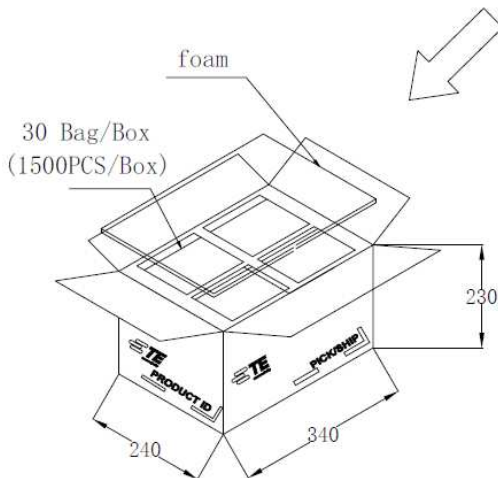

5G/4G/3G/2G, NB-IoT, Cat-M, GNSS, Wi-Fi 6E WORLD BAND ANTENNA

Standard Antenna Solutions

TE TECHNICAL SUPPORT CENTER

USA:	+1 (800) 522-6752
Canada:	+1 (905) 475-6222
Mexico:	+52 (0) 55-1106-0800
Latin/S. America:	+54 (0) 11-4733-2200
Germany:	+49 (0) 6251-133-1999
UK:	+44 (0) 800-267666
France:	+33 (0) 1-3420-8686
Netherlands:	+31 (0) 73-6246-999
China:	+86 (0) 400-820-6015

For phone numbers in other countries, go to te.com/support-center

te.com

TE Connectivity, TE Connectivity (logo) and Every Connection Counts are trademarks. All other logos, products and/or company names referred to herein might be trademarks of their respective owners.

The information given herein, including drawings, illustrations and schematics which are intended for illustration purposes only, is believed to be reliable. However, TE Connectivity makes no warranties as to its accuracy or completeness and disclaims any liability in connection with its use. TE Connectivity's obligations shall only be as set forth in TE Connectivity's Standard Terms and Conditions of Sale for this product and in no case will TE Connectivity be liable for any incidental, indirect or consequential damages arising out of the sale, resale, use or misuse of the product. Users of TE Connectivity products should make their own evaluation to determine the suitability of each such product for the specific application.

© 2020 TE Connectivity Ltd. family of companies All Rights Reserved.

12/2020

Mouser Electronics

Authorized Distributor

Click to View Pricing, Inventory, Delivery & Lifecycle Information:

[TE Connectivity:](#)

[2195846-1](#)