

DEUTSCH DMC-MD SERIES

SINGLE MODULE EN4165, ARINC 809,
BACC65 CONNECTORS

Quick Change Modular Connector Solutions
For Aircraft IFE and Cabin Systems

Table of Contents

Introduction	3
Overview and Specifications	4 - 5
Part Numbering System	
Shells	6
Accessories	7
Backshells (and Plugs)	8
Backshells (and Receptacles)	9
Additional Parts	10
Shell Dimension and Panel Mounting	11
Modules	12 - 13
Panel Mount Cutout Dimensions	14 - 15

FLEXIBLE MODULARITY FOR CABIN SYSTEMS

MODULARITY

- Crimp and PCB contacts size 24 to size 8
- Signal, coaxial, QuadraX, power, and optical contacts
- High-speed Ethernet modules
- Aluminum cable compliant
- Easily replaced modules for fast reconfiguration
- Allows mixing of male and female modules in each connector half
- Wide range of modules allows great flexibility in configuration

EASY TO INSTALL

- Multiple keying possibilities
- Quick-install coupling
- Toolless assembly

RELIABILITY

- Environmental sealing
- Vibration resistant
- EMI protection as per EN4165 standard
- Meets FAA flammability, smoke, and toxicity requirements
- EN4165, ARINC 809, and BACC65 compliant

WEIGHT OPTIMIZATION

- Nickel-plated composite shells
- Compact solution

Originally designed in the 1980s, DEUTSCH DMC-MD connectors have evolved into one of the most widely used connector styles for cabin applications in commercial aerospace. Standardized in European Standard EN4165, DMC-MD connectors provide a modular, flexible, and reliable system. The connectors are available in both multi-cavity and single-module configurations, using the same modules, to provide compact, lightweight connectivity.

DEUTSCH DMC-MD Single-Module Connectors



TE Components . . . TE Technology . . . TE Know-how . . .
AMP | AGASTAT | CII | HARTMAN | KILOVAC | MICRODOT | NANONICS | POLAMCO | Raychem
SEACON | Rochester | DEUTSCH

Empower Engineers to Solve Problems, Moving the World Forward.

THE STANDARD CONNECTOR FOR 4TH GENERATION CABIN NETWORKS

ARINC 809, BACC65, EN4165



QUALIFIED

- EN4165
- ARINC 809
- BACC65

APPLICATIONS

- Cabin Systems
- In-Flight Entertainment
- Avionics



Specifications

MATERIALS

- **Housing:** Composite, nickel plated
- **Modules:** Thermoplastic and fluoronated silicone
- **Crimp Contacts:** Copper alloy, plated gold over nickel
- **PCB Contacts:** Copper alloy, plated gold over nickel, with lead or RoHS tinning option

MECHANICAL/ENVIRONMENTAL

- **Temperature Range:** -55°C to +175°C
- **Vibration:** 20 g
- **Durability:** 500 mating cycles
- **Salt Spray:** 500 hours
- **Interfacial Sealing:** 1.1 x 10⁻² bar

ELECTRICAL

- **Insulation Resistance:** 5000 MΩ
- **Contact Current Rating:**
 - Size 24: 3 A
 - Size 23: 5 A
 - Size 22: 5 A
 - Size 20: 7.5 A
 - Size 16: 13 A
 - Size 12: 23 A
 - Size 8: 46 A

EMI SHIELDING PERFORMANCE

Frequency (MHz)	100	200	300	400	800	1000
Attenuation (dB)	50	45	45	40	35	30

WEIGHT

Extender Receptacle	Short Receptacle	Plug	Backshell
7 gr	6 gr	9 gr	4 - 7 gr
0.015 lbs	0.013 lbs	0.020 lbs	0.009 - 0.015 lbs

Schematic

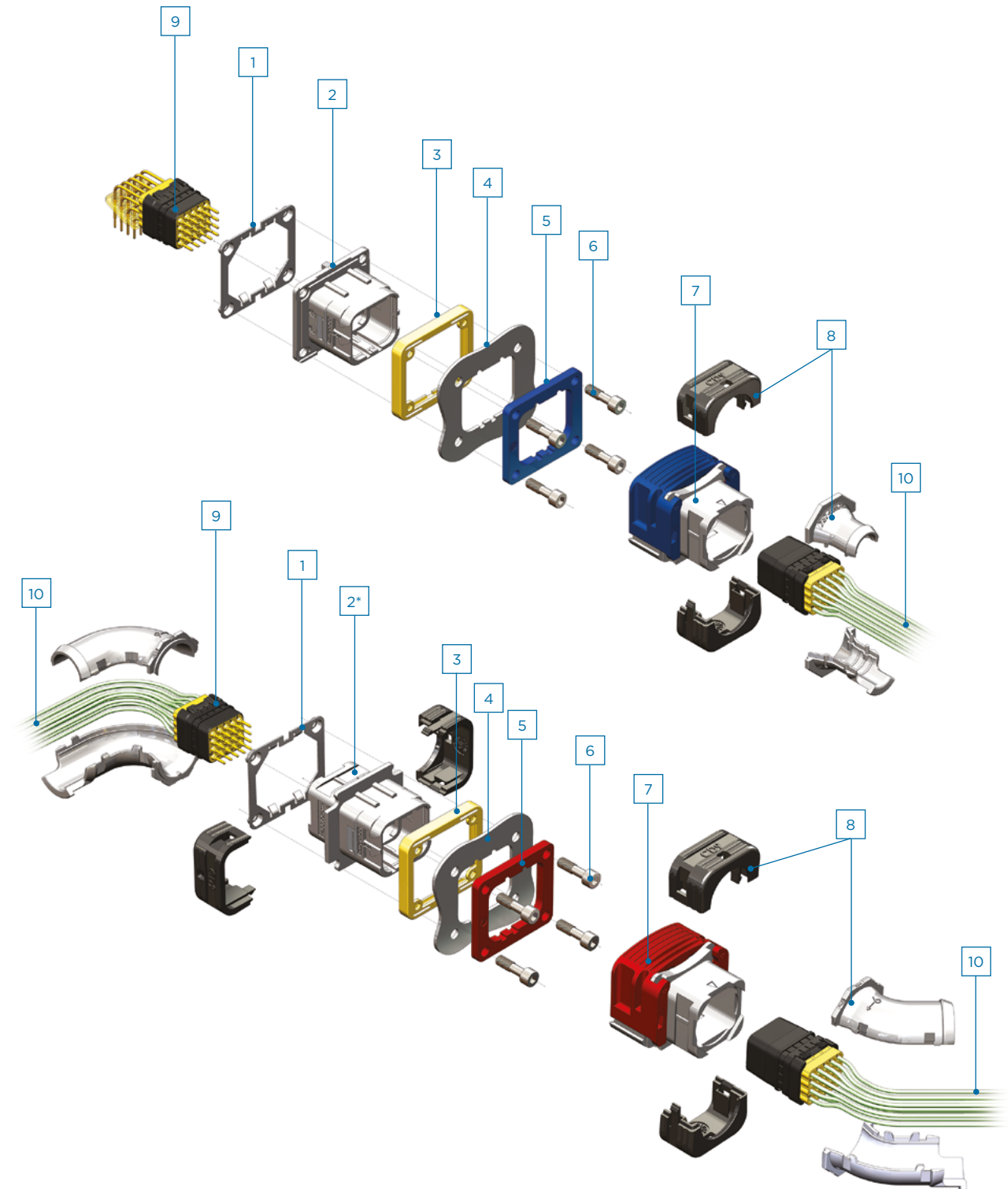

- | | | |
|---------------------------|-------------------------------|-------------|
| 1 Nut plate (option) | 4 Panel (up to 2 mm thick) | 8 Backshell |
| 2 Short receptacle | 5 Color coding plate (option) | 9 Modules |
| 2* Extender receptacle | 6 Screws (not supplied) | 10 Cables |
| 3 Sealing gasket (option) | 7 Plug | |



DESIGNATION SYSTEM FOR SHELLS

DMC-MD 24 D - K - S - T

DEUTSCH CONNECTOR TYPE

SHELL TYPE

- 20 Plug
- 24 Short Receptacle
- 26 Extender Receptacle

SHELL KEYING

N, A, B, C, D, E, F, G

CODING PLATE (Receptacles Only)

- K With (Omit for Without)

SEALING GASKET (Receptacles Only)

- S With (Omit for Without)

NUT PLATE (Receptacles Only)

- T With (Omit for Without)

EN STANDARD

EN4165 M O 1 A D 1 G 1

FINISH

- M Composite, Nickel Plating

SHELL TYPE

- 6 Plug
- 0 Short Receptacle
- 7 Extender Receptacle

SHELL TYPE

- 1 Single Module

TYPE

- A Series 2

SHELL KEYING

N, A, B, C, D, E, F, G

CODING PLATE (Receptacles Only)

- 0 Without
- 1 With

SEALING GASKET (Receptacles Only)

- U Without
- G With

NUT PLATE (Receptacles Only)

- 0 Without
- 1 With

BOEING STANDARD

BACC65 BV M D

SHELL TYPE

- BU Plug
- BV Short Receptacle
- CA Extender Receptacle

FINISH

- M Composite, Nickel Plated

SHELL KEYING

N, A, B, C, D



DESIGNATION SYSTEM FOR ACCESSORIES

787-8055 - 20 M

DEUTSCH CONNECTOR TYPE

ACCESSORIES TYPE

- 10 Straight Chimney
- 11 Clampshell
- 12 Straight Tie Wrap Ø 7
- 13 Straight Tie Wrap Ø 10
- 20 45° Indexable Chimney
- 21 45° Indexable Chimney Tie Wrap
- 30 90° Indexable Chimney
- 31 90° Indexable Chimney Tie Wrap

PLATING

- M Nickel

EN STANDARD

EN4165 M 20

FINISH

- M Composite, Nickel Plating

ACCESSORIES TYPE

- 10 Straight Chimney
- 20 45° Indexable Chimney
- 30 90° Indexable Chimney
- 10 A Straight Tie Wrap Ø 10
- 20 A 45° Indexable Chimney Tie Wrap
- 30 A 90° Indexable Chimney Tie Wrap



BACKSHELLS

STRAIGHT CLAMPSHELL
787-8055-11M
Screws delivered

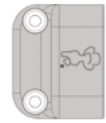

STRAIGHT CHIMNEY
787-8055-10M
EN4165-026M10

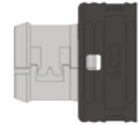

STRAIGHT CHIMNEY
TIE WRAP Ø 7
787-8055-12M

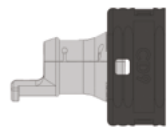

STRAIGHT CHIMNEY
TIE WRAP Ø 10
787-8055-13M
EN4165-026M10A

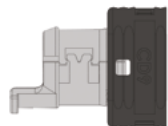

45° INDEXABLE CHIMNEY
787-8055-20M
EN4165-026M20



45° INDEXABLE CHIMNEY
TIE WRAP
787-8055-21M
EN4165-026M20A

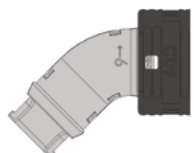

90° INDEXABLE CHIMNEY
787-8055-30M
EN4165-026M30

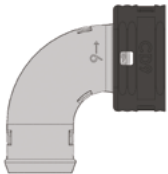

90° INDEXABLE CHIMNEY
TIE WRAP
787-8055-31M
EN4165-026M30A

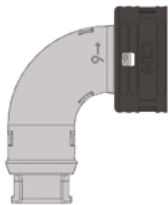

PLUGS

DMC-MD 20 N
BACC65BUMN
EN4165M61AN

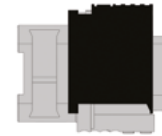

DMC-MD 20 A
BACC65BUMA
EN4165M61AA



DMC-MD 20 B
BACC65BUMB
EN4165M61AB



DMC-MD 20 C
BACC65BUMC
EN4165M61AC



DMC-MD 20 D
BACC65BUMD
EN4165M61AD



DMC-MD 20 E
EN4165M61AE

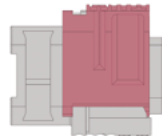

DMC-MD 20 F
EN4165M61AF

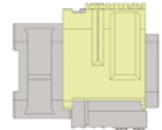

DMC-MD 20 G
EN4165M61AG

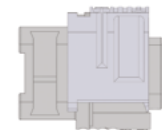

TE/DEUTSCH Part Numbers (DMC-MD / 787)
BOEING Part Numbers (BACC65)
STANDARD Part Numbers (EN4165)



RECEPTACLES

EXTENDER RECEPTACLE

DMC-MD 26 *X
BACC65CAM*X
EN4165M71A*X

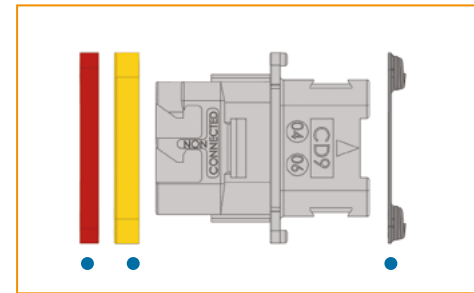

• : To be ordered separately
(no BACC65 references)



SHORT RECEPTACLE

DMC-MD 24 *X
BACC65BVM*X
EN4165M01A*X

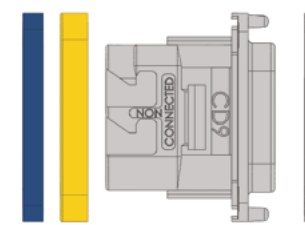

• : To be ordered separately
(no BACC65 references)

**NO ACCESSORY CAN BE USED
WITH THIS RECEPTACLE**

TE/DEUTSCH Part Numbers (DMC-MD / 787)
BOEING Part Numbers (BACC65)
STANDARD Part Numbers (EN4165)

BACKSHELLS

STRAIGHT CLAMPSHELL
787-8055-11M
Screws delivered



STRAIGHT CHIMNEY
787-8055-10M
EN4165-026M10



STRAIGHT CHIMNEY
TIE WRAP Ø 7
787-8055-12M



STRAIGHT CHIMNEY
TIE WRAP Ø 10
787-8055-13M
EN4165-026M10A



45° INDEXABLE CHIMNEY
787-8055-20M
EN4165-026M20



45° INDEXABLE CHIMNEY
TIE WRAP
787-8055-21M
EN4165-026M20A



90° INDEXABLE CHIMNEY
787-8055-30M
EN4165-026M30



90° INDEXABLE CHIMNEY
TIE WRAP
787-8055-31M
EN4165-026M30A





OPTIONAL PARTS FOR RECEPTACLE

Keying Plate

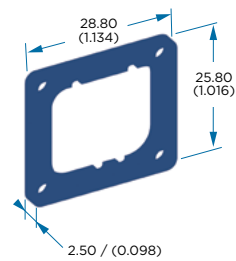

- N: 787-0015-00 EN4165-25CN
- A: 787-0015-01 EN4165-25CA
- B: 787-0015-02 EN4165-25CB
- C: 787-0015-03 EN4165-25CC
- D: 787-0015-04 EN4165-25CD
- E: 787-0015-05 EN4165-25CE
- F: 787-0015-06 EN4165-25CF
- G: 787-0015-07 EN4165-25CG

Sealing Gasket

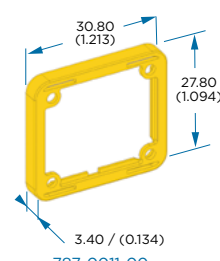

787-0011-00
EN4165-25E

Nut Plate

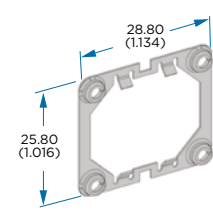

Recommended Screw Torque
0.5 ±0.1 N.m or 4.4 ±0.9 in.lbf
787-0016-00
EN4165-25D

Panel Mounting Bracket

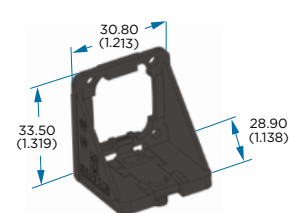

787-8014-00

PROTECTIVE CAPS



Protection Level	Plug Cap	Receptacle Cap	ESD Receptacle Cap	Receptacle and Extender Cap	Plug Flight Cap	Receptacle and Extender Flight Cap
	104-0236-00	104-0235-00	104-0334-00	With Lanyard: 787-8011-00 W/O Lanyard: 787-8009-00	787-8010-00	With Lanyard: 787-8017-00 EN4165M3C W/O Lanyard: 787-8016-00
Shipping	X	X	X	-	-	-
Dust	X	X	X	X	X	X
EMI	-	-	X	-	X	X
Low Pressure Sealing	-	-	-	-	X	X



MOUNTING BRACKETS

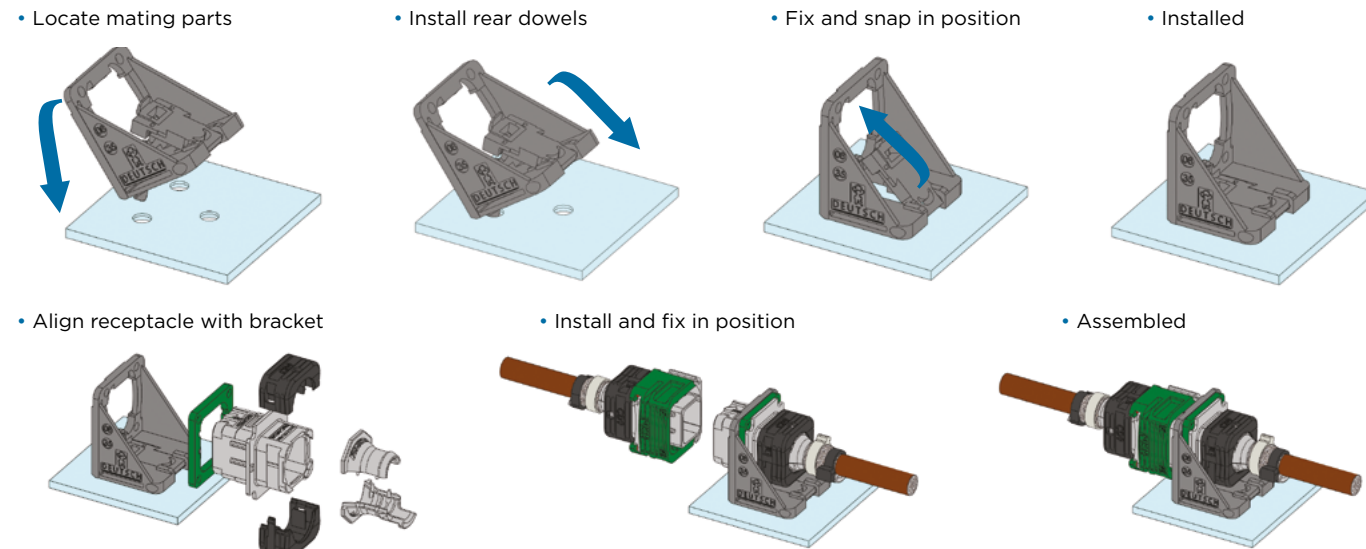

RECEPTACLES & PLUG

Receptacle

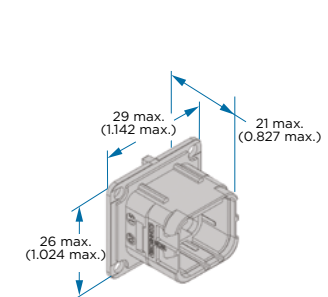

Extender Receptacle

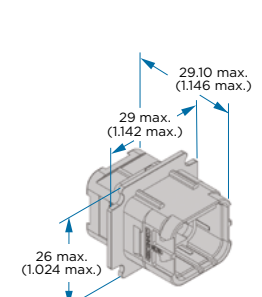

Plug

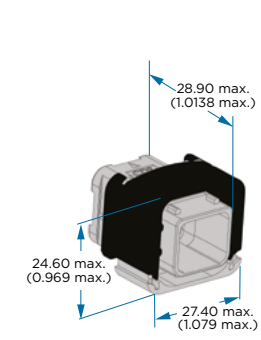

BACKSHELL / CHIMNEY INDEXATION

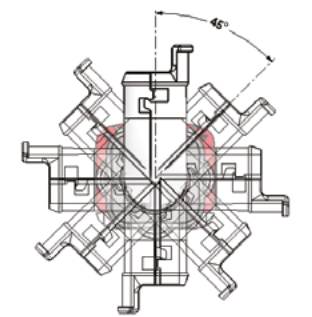

All backshells can be indexed in eight positions on the rear of plug and extender receptacle shell. This gives maximum flexibility during design and cable installation and reduces the number of variants and components.

MOUNTING PANEL DETAILS

Box Mounting Receptacle

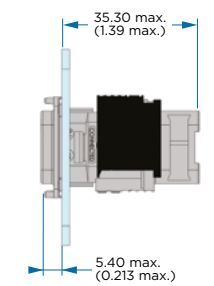

Extender Receptacle

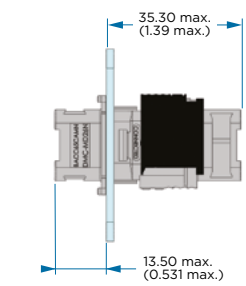

Straight Chimney

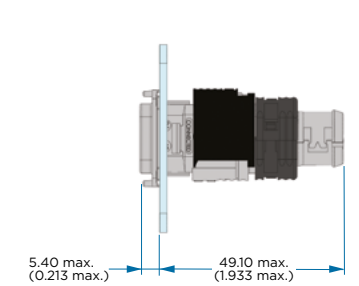

Straight Clampshell

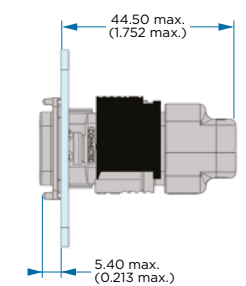

Straight Chimney Tie Wrap

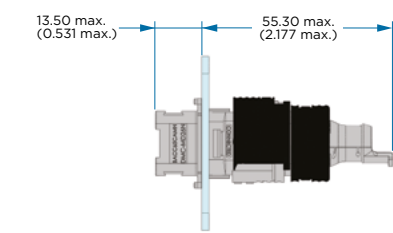

Universal Unshielded Accessory

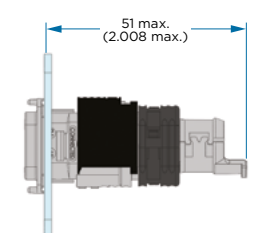

45° Indexable Chimney

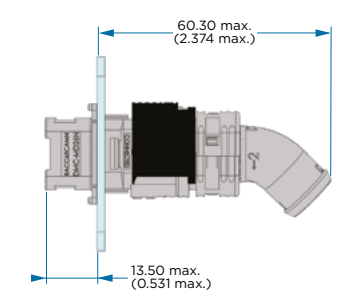

45° Indexable Chimney Tie Wrap

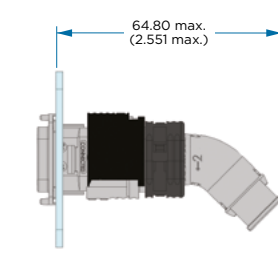

90° Indexable Chimney

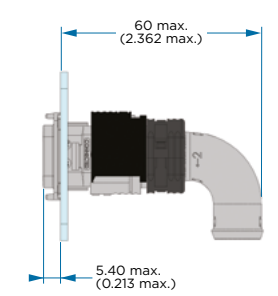



ELECTRICAL MODULES / AS39029/57 AND /58 AND EN3155 CONTACT COMPLIANT

Configuration	Pin Contacts		Socket Contacts	
	View	Part No.	View	Part No.
30 Size 23 Contacts		DMC-MR 30-23 AN		DMC-MR 30-23 BN
20 Size 22 Contacts		DMC-M 20-22 AN BAC110BC2022PNB EN4165A20-221NA		DMC-M 20-22 BN BAC110BC2022SNB EN416520-22 A1NB
20 Size 22 Contacts		DMC-MA 20-22 AN EN4165A20A221NA		DMC-MA 20-22 BN EN4165A20A221NB
12 Size 20 Contacts		DMC-M 12-20 AN BAC110BC1220PNB EN4165A12-201NA		DMC-M 12-20 BN BAC110BC1220SNB EN4165A12-201NB
8 Size 16 Contacts		DMC-M 08-16 AN BAC110BC0816PNB EN4165A08-161NA		DMC-M 08-16 BN BAC110BC0816SNB EN4165A08-161NB
4 Size 12 Contacts		DMC-M 04-12 AN EN4165A04-121NA		DMC-M 04-12 BN EN4165A04-121NB
1 Size 8 Contact		DMC-M 01-08 AN EN4165A01-081NA		DMC-M 01-08 BN EN4165A01-081NB
6 Size 16 Contacts 5 Size 22 Contacts		DMC-M 99-01 AN BAC110BC1622PNB EN4165A99-011NA		DMC-M 99-01 BN BAC110BC1622SNB EN4165A99-011NB
8 Size 22 Contacts 2 Size 12 Contacts		DMC-M 99-06 AN BAC110BC1001PNB		DMC-M 99-06 BN BAC110BC1001SNB
8 Size 20 Contacts 2 Size 16 Contacts		DMC-M 99-10 AN EN4165A99-101NA		DMC-M 99-10 BN EN4165A99-101NB
6 Size 16 Contacts 5 Size 22 Contacts		DMC-MA 99-01 AN EN4165A99A011NA		DMC-MA 99-01 BN EN4165A99A011NB

ELECTRICAL MODULES / BACC47 CONTACT COMPLIANT

Configuration	Pin Contacts		Socket Contacts	
	View	Part No.	View	Part No.
8 Size 20 Contacts 2 Size 16 Contacts		DMC-MB 99-10 AN BAC110BC0910PNB		DMC-MB 99-10 BN BAC110BC0910SNB
12 Size 20 Contacts		DMC-MB 12-20 AN BAC110BC1220APNB		DMC-MB 12-20 BN BAC110BC1220ASNB

Note : DMC-MD connector modules are compatible with aluminium cable contacts and with EN3155-70 / 71 size 22.

Aluminium cable technology possible with size 22 contacts

TE/DEUTSCH Part Numbers (DMC-MD / 787)
BOEING Part Numbers (BAC110BC)
STANDARD Part Numbers (EN4165)



BLANKING MODULES

Configuration	View	Part No.
Blanking Module		DMC-M 00-00 PN EN4165-1N

SHUNT MODULES

Configuration	View	Part No.
20 Size 22 Contacts 5 Shunts 4 Ways		DMC-M 22-05 BN EN4165A20Y221NB
20 Size 22 Contacts 3 Shunts 4 Ways 4 Shunts 2 Ways		DMC-M 22-07 BN EN4165A2AY221NB
20 Size 22 Contacts 10 Shunts 2 Ways		DMC-M 22-10 BN EN4165A2BY221NB

Distribution shunt modules use dedicated contacts based on standard AS39029. The shunt modules can only be mated with DMC-M 20-22 AN or DMC-MA 20-22 AN modules.

HIGH-SPEED ETHERNET MODULES

Configuration	Pin Contacts		Socket Contacts	
	View	Part No.	View	Part No.
6 Size 16 Contacts 2 Size 22 Contacts 8 Size 24 Contacts		2226454-1		2226455-1
8 Size 22 Contacts 3 Size 20 Contacts		DMC-M 99-02 AN		DMC-M 99-02 BN
8 Size 20 Contacts 8 Size 24 Contacts		DMC-M 99-03 AN		DMC-M 99-03 BN
6 Size 20 Contacts 2 Size 22 Contacts 8 Size 24 Contacts		DMC-M 99-04 AN		DMC-M 99-04 BN

FIBER OPTIC AND HYBRID MODULES

Configuration	Module Part No.				Alignment Sleeve
	Pin	Part No.	Socket	Part No.	
6 MC5 Termini		458235		458238	458237-C (Ceramic) 458237-M (Metal)
1 MT Ferrule (12 or 24 Fibers)		DMC-M01-MC6N		DMC-M01-MC6N	Not required
2 ARINC 801 Termini 5 Size 16 Contacts 2 Size 22 Contacts		459736 459736-P (With Contacts) 459823 (Right Angle)		459737 (Ceramic Sleeve) 459737-S (Ceramic Sleeve with Contacts) 459737-M (Metal Sleeve) 459737-M-S (Metal Sleeve with Contacts)	Included with socket module

Note : DMC-M connector's modules are compatible with aluminium cable contacts and with EN3155-70 / 71 size 22.

TE/DEUTSCH Part Numbers (DMC-MD / 787)
BOEING Part Numbers (BAC110BC)
STANDARD Part Numbers (EN4165)

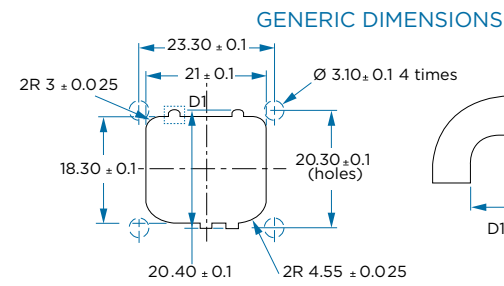
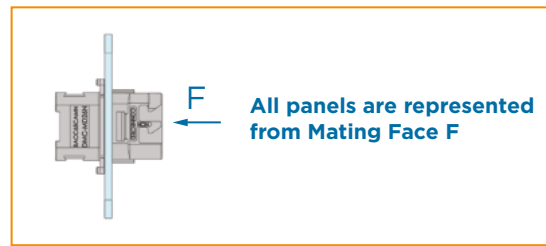

Note: Dimensions are in millimeters. Each hole Ø 3.1 mm must receive a No. 4-40 screw (not supplied)
Recommended thickness panel: 0.8 mm min. - 2 mm max.

PANEL MOUNTING BRACKET CUTOUT DETAILS

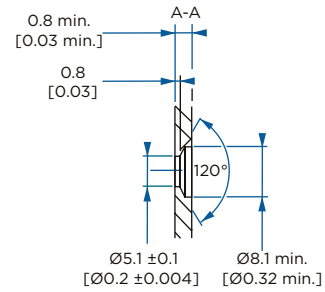
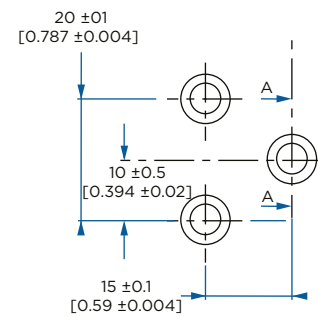

Overall dimensions and characteristics are given for indication guidance only. TE Connectivity reserves the right to modify them for production improvement reasons.

FREE

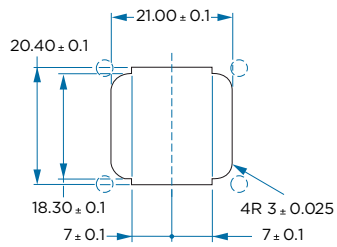

ORIENTATION

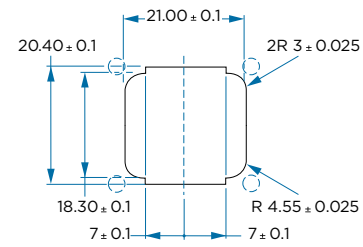

Recommended screw torque is 0.5 ± 0.1 N.m or 4.4 ± 0.9 in.lbf



PANEL CODING KEYING

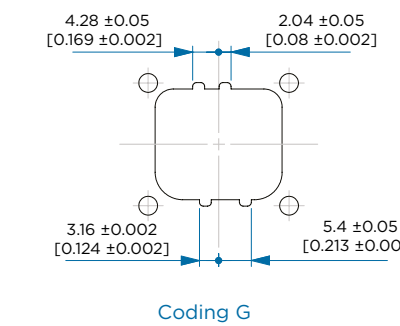
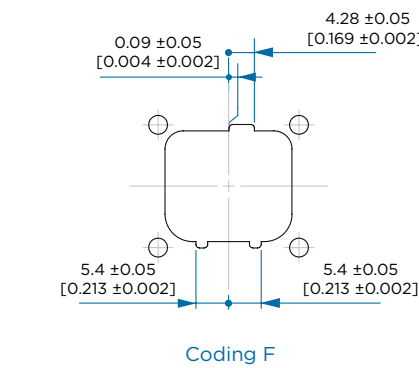
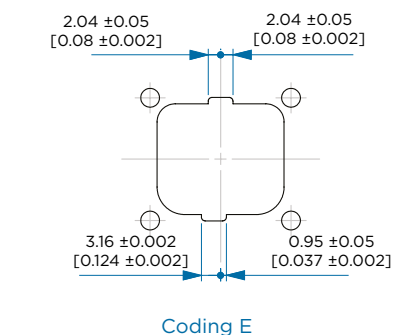
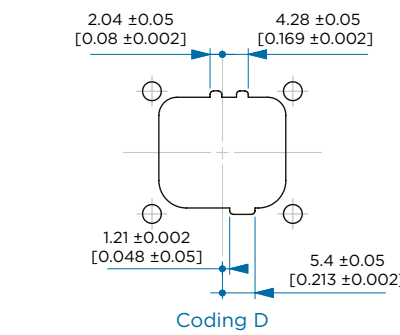
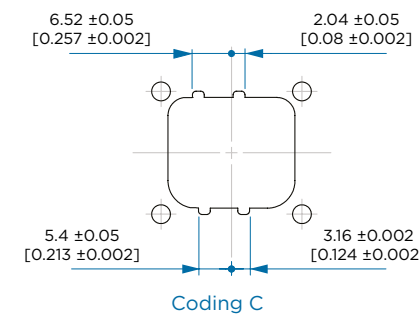
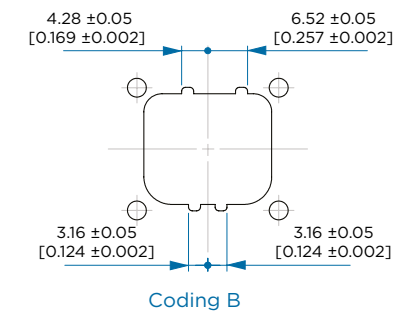
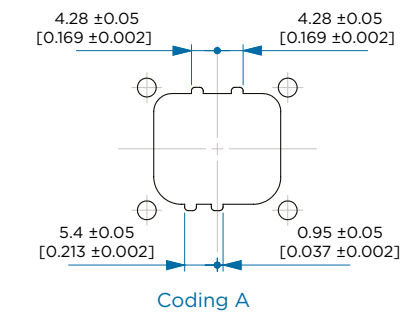
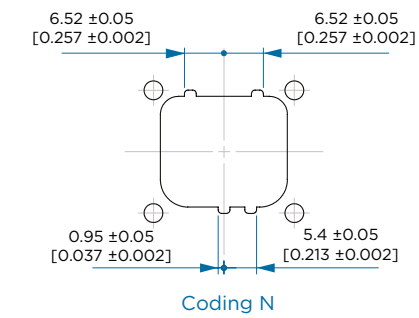

LET'S CONNECT

We make it easy to connect with our experts and are ready to provide all the support you need. Just call your local support number or visit www.te.com/industrial to chat with a Product Information Specialist.

Technical Support

te.com/support-center

North America	+1 800 522 6752	Asia Pacific	+86 400 820 6015
North America (Toll)	+1 717 986 7777	Japan	044 844 8180
EMEA/South Africa	+800 0440 5100	Australia	+61 2 9554 2695
EMEA (Toll)	+31 73 624 6999	New Zealand	+64 (0) 9 634 4580
India (Toll-Free)	+800 440 5100		

QUICK CHANGE MODULAR CONNECTOR SOLUTIONS FOR AIRCRAFT IFE AND CABIN SYSTEMS



te.com/dmc-m

AMP, AGASTAT, CII, DEUTSCH, HARTMAN, KILOVAC, MICRODOT, NANONICS, POLAMCO, Raychem, Rochester, SEACON, TE, TE Connectivity and the TE connectivity (logo) are trademarks of the TE Connectivity Ltd. family of companies. Other products, logos, and company names mentioned herein may be trademarks of their respective owners.

While TE Connectivity (TE) has made every reasonable effort to ensure the accuracy of the information herein, nothing herein constitutes any guarantee that such information is error-free, or any other representation, warranty or guarantee that the information is accurate, correct, reliable or current. The TE entity issuing this publication reserves the right to make any adjustments to the information contained herein at any time without notice. All implied warranties regarding the information contained herein, including, but not limited to, any implied warranties of merchantability or fitness for a particular purpose are expressly disclaimed. The dimensions herein are for reference purposes only and are subject to change without notice. Specifications are subject to change without notice.

Consult TE for the latest dimensions and design specifications.

© 2019 TE Connectivity Ltd. family of companies All Rights Reserved.

1-1773725-9 07/19

Mouser Electronics

Authorized Distributor

Click to View Pricing, Inventory, Delivery & Lifecycle Information:

[TE Connectivity:](#)

[ZPF00000000203709](#)