

PROPERTY OF DEUTSCH D.A.O.  
 THIS DRAWING CONTAINS PROPRIETARY INFORMATION THAT SHALL NOT BE DISCLOSED, DUPLICATED,  
 NOR USED IN WHOLE OR IN PART FOR ANY PURPOSE OTHER THAN TO EVALUATE THIS DRAWING.

A DTS24\*\*\*\*-\*\*\*\*

REVISIONS			
REV	DESCRIPTIONS	DATE	APPROVED
N/C	NEW RELEASE PER E.O.H4540	4/14/09	M.A.
A	REVISED PER E.O.H4608	100504	M.A.



STUB 60° MOD.  
 TRIPLE START THREAD  
 "E"-.1P-.3L CLASS 2A  
 (SEE COLUMN "E THREAD")



RECOMMENDED PANEL CUT OUT

SHELL SIZE	L	M
9	.670	.700
11	.771	.825
13	.955	1.010
15	1.085	1.135
17	1.210	1.260
19	1.335	1.385
21	1.460	1.510
23	1.585	1.635
25	1.710	1.760

PART NUMBER BREAKDOWN: DTS 24 Y 17-35 P N

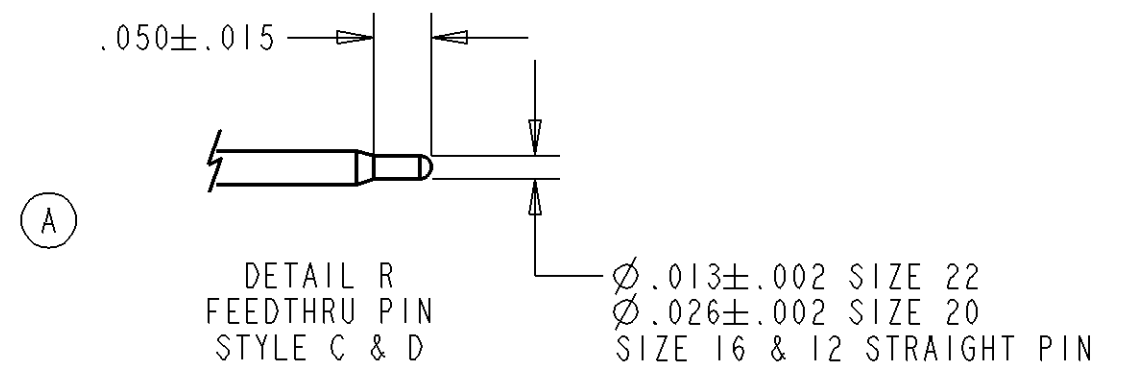

- DIMENSIONS ARE IN INCHES UNLESS OTHERWISE NOTED.
  - INSERT ARRANGEMENT CONFORMS TO MIL-STD-1560.
  - LEAK RATE THROUGH GLASS INSERT: <1E-8 cc/sec He @ 1 atm.
  - FINISH: SHELL - ELECTRO-POLISH  
PIN CONTACTS - GOLD OVER NICKEL
  - MATERIAL: SHELL & JAM NUT - STAINLESS STEEL  
PIN CONTACTS - HIGH NICKEL IRON ALLOY OR EQUIVALENT  
GLASS - COMPRESSION GLASS  
INTERFACIAL SEAL & O-RING- FLUOROSILICONE ELASTOMER
  - MATES WITH DTS26 SERIES PLUG CONNECTOR.
  - CONNECTOR MEETS REQUIREMENTS OF MIL-DTL-38999 SERIES III.
  - CONSULT CUSTOMER SERVICE FOR ARRANGEMENT AVAILABILITY.
- NOTE(S):

SHELL SIZE	A	B	C	D	E THREAD	F THREAD	G	H	J	K PIN SOC	N	
9	1.063	.651	1.150	.642	.6250	M17	1.189	.358	.102	.209	.232	.875
11	1.252	.751	1.150	.764	.7500	M20	1.374	.358	.102	.209	.232	1.000
13	1.374	.938	1.150	.894	.8750	M25	1.500	.358	.102	.201	.224	1.188
15	1.500	1.062	1.150	1.020	1.0000	M28	1.626	.358	.102	.201	.224	1.375
17	1.626	1.187	1.150	1.142	1.1875	M32	1.752	.358	.102	.201	.224	1.437
19	1.811	1.312	1.185	1.268	1.2500	M35	1.937	.382	.134	.201	.224	1.563
21	1.937	1.437	1.185	1.394	1.3750	M38	2.063	.382	.134	.201	.224	1.750
23	2.063	1.562	1.185	1.520	1.5000	M41	2.189	.382	.134	.201	.224	1.875
25	2.189	1.687	1.185	1.642	1.6250	M44	2.311	.382	.134	.201	.224	2.000

\$ SIZE 17, MODIFIED MAJOR Ø 31.95-31.80 mm FILE:DTS24XXX-XXPX-ENV-SNAP

SIGNATURE & DATE	
DR	S.LUI 4/8/09
CHK	M.ALLEN 4/14/09
PE	
APPD	A.RENGIFO 4/16/09
SCALE:	

CONNECTOR, RECEPTACLE  
 HERMETIC  
 JAM-NUT MOUNT  
 THREAD COUPLING  
 MIL-DTL-38999/23  
 ENVELOPE

NBO MATL CODE 72

**DEUTSCH**  
 ENGINEERED INTERCONNECT SOLUTIONS  
 250 Eddie Jones Way  
 Oceanside, CA 92058

**C** DTS24\*\*\*\*-\*\*\*\*  
 DWG SIZE CAGE CODE 11139 SHEET 1 OF 1

# Mouser Electronics

Authorized Distributor

Click to View Pricing, Inventory, Delivery & Lifecycle Information:

[TE Connectivity:](#)

[YDTS24T21-11SA6157](#)