

REVISIONS					
P	LTR	DESCRIPTION	DATE	DWN	APVD
B		REVISED PER ECO-19-013635	05SEP2019	JM	EO

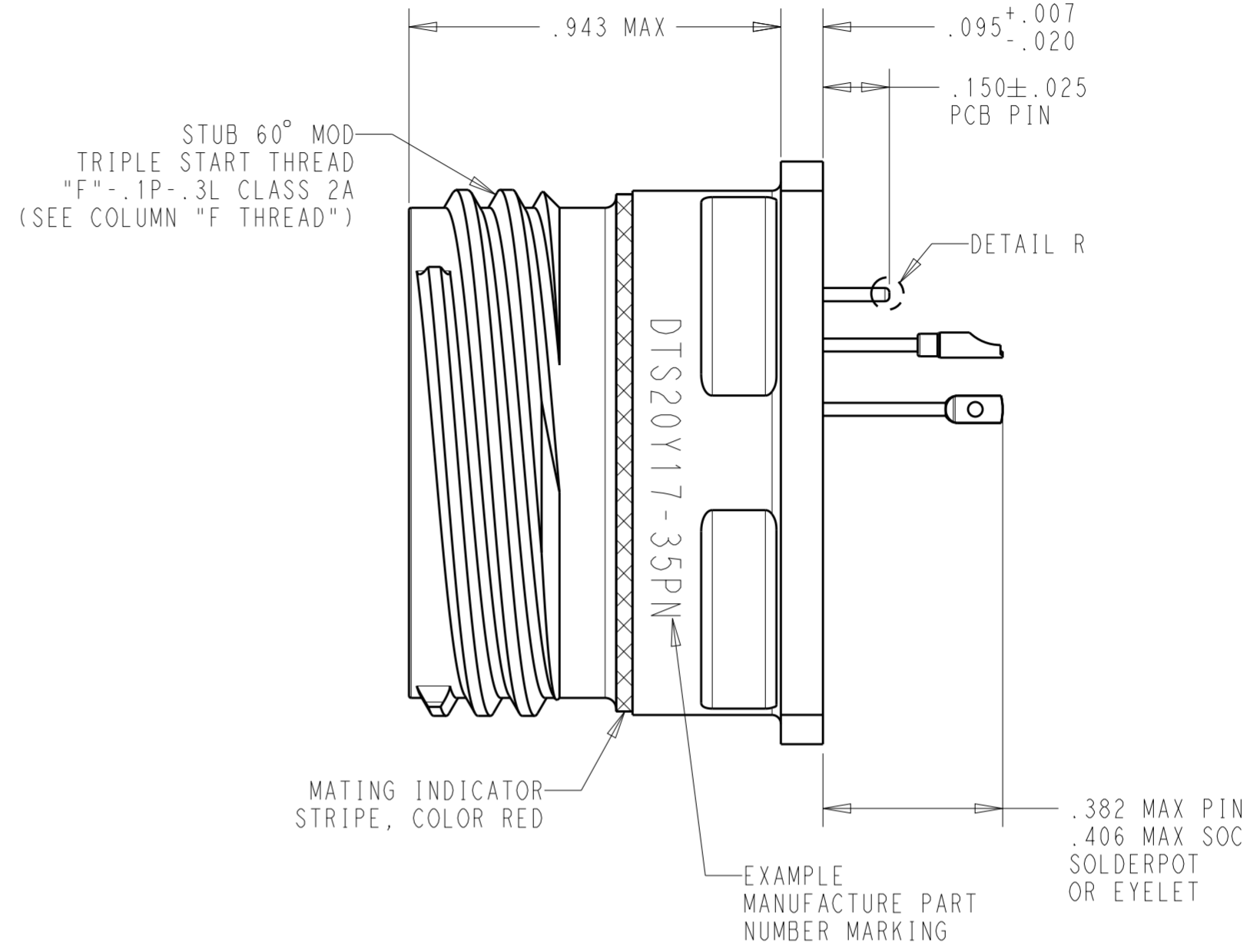

PART NUMBER BREAKDOWN: DTS 20 Y 17-35 P N

- SHELL KEYING POSITIONS: N, A, B, C, D OR E
- CONTACT PIN STYLE: P = SOLDERCUP, X = EYELET, C = PCB PIN
CONTACT SOC STYLE: S = SOLDERCUP, Z = EYELET, D = PCB PIN
- INSERT ARRANGEMENT
- SHELL SIZE: 9, 11, 13, 15, 17, 19, 21, 23, OR 25
- CLASS: N = NICKEL PLATE OVER STAINLESS STEEL
Y = ELECTRO-POLISHED STAINLESS STEEL
H = SAME AS CLASS "Y" BUT SPACE GRADE
- SHELL MOUNTING STYLE: 20 = BOX FLANGE MOUNT
- BASIC IDENTIFIER: 38999 SERIES III HERMETIC RECEPTACLE

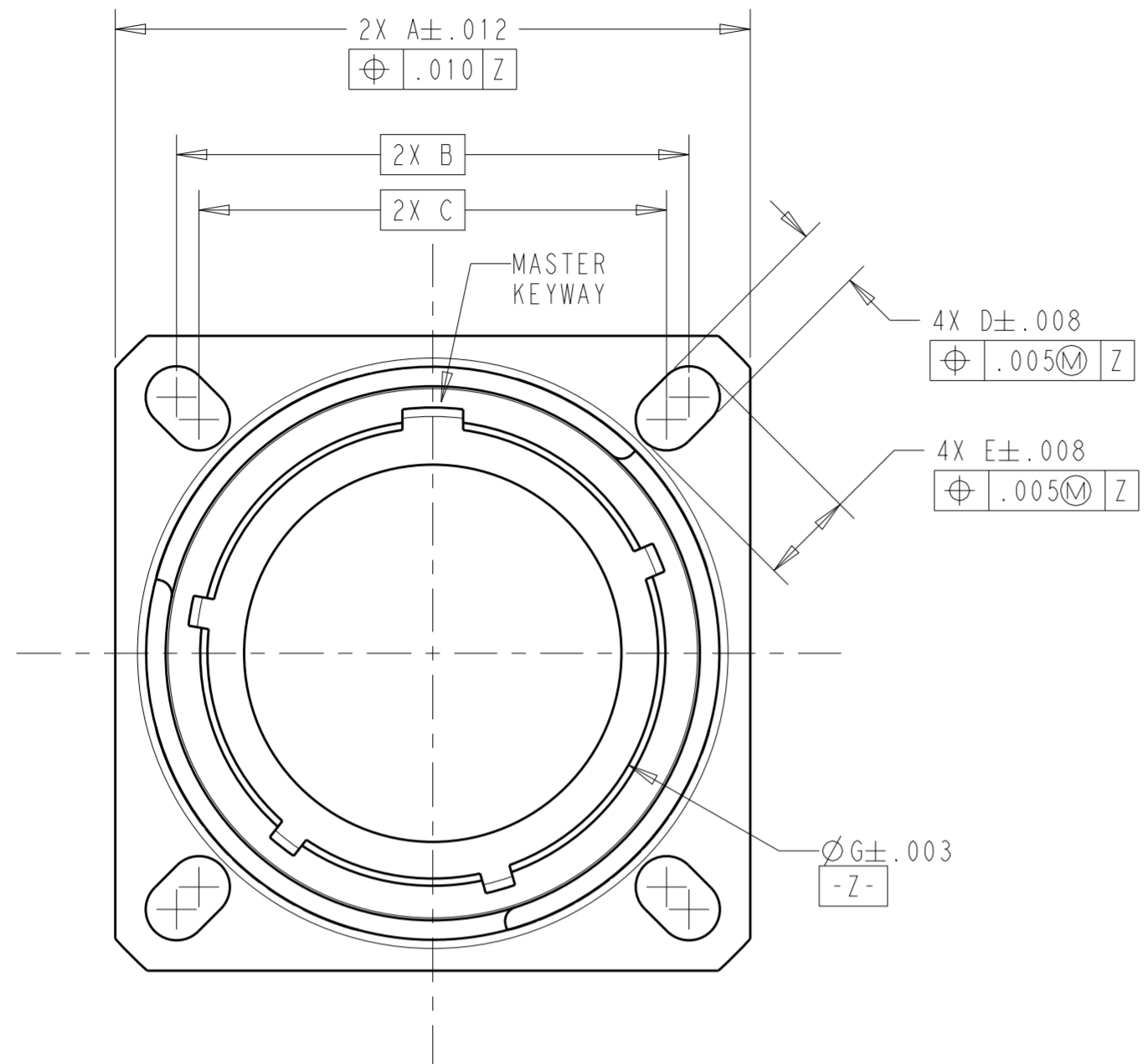
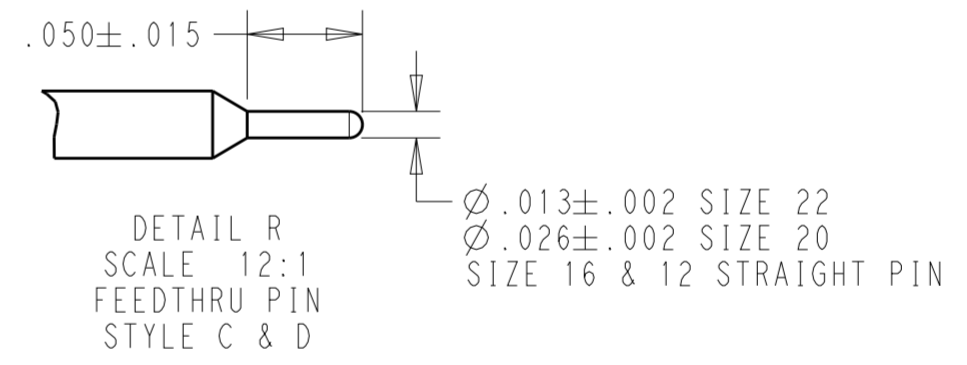

1. DIMENSIONS ARE INCHES UNLESS OTHERWISE NOTED
2. INSERT ARRANGEMENT CONFORMS TO MIL-STD-1560
3. LEAK RATE: <IE-8 cc/sec He @ 1 atm
4. FINISH: SHELL - STAINLESS STEEL
PIN CONTACTS - HIGH NICKEL IRON ALLOY OR EQUIVALENT
GLASS - COMPRESSION GLASS
PIN INSERT & INTERNAL SEAL - FLUOROSILICONE ELASTOMER
5. MATERIAL: SHELL - STAINLESS STEEL
PIN CONTACTS - HIGH NICKEL IRON ALLOY OR EQUIVALENT
GLASS - COMPRESSION GLASS
PIN INSERT & INTERNAL SEAL - FLUOROSILICONE ELASTOMER
6. MATES WITH DTS26 SERIES PLIUG CONNECTOR
7. CONNECTOR MEETS REQUIREMENT OF MIL-STL-38999 SERIES III
8. CONSULT CUSTOMER SERVICE FOR ARRANGEMENT AVAILABILITY
9. MOUNYING INFORMATION: DIMENSION "B" FRONT OR REAR PANEL MOUNT
DIMENSION "C" FRONT PANEL MOUNT ONLY

SHELL SIZE	A	B	C	D	E	F THREAD	G
9	.937	.719	.594	.128	.216	.6250	.444
11	1.032	.812	.719	.128	.194	.7500	.572
13	1.126	.906	.812	.128	.194	.8750	.684
15	1.221	.969	.906	.128	.173	1.0000	.808
17	1.311	1.062	.969	.128	.194	1.1875	.934
19	1.437	1.156	1.062	.128	.194	1.2500	1.039
21	1.563	1.250	1.156	.128	.194	1.3750	1.164
23	1.689	1.375	1.250	.154	.242	1.5000	1.289
25	1.811	1.500	1.375	.154	.242	1.6250	1.414

MC: 72	FINISH:
DESCRIPTION: CONNECTOR, RECEPTACLE	
HERMETIC SQUARE FLANGE MOUNT THREAD COUPLING MIL-DTL-38999/21	
ENVELOPE	
CP	CAGE CODE 11139
PART TO HAVE NO BURRS OR SHARP EDGES	

THIS DRAWING IS A CONTROLLED DOCUMENT.

DIMENSIONS: in	TOLERANCES UNLESS OTHERWISE SPECIFIED: 0 PLC ±.1 1 PLC ±.02 2 PLC ±.005 3 PLC ±.0005 4 PLC ±.0005 ANGLES ±.5° FINISH	DWN 05SEP2019 JUAN MONTEMAYOR CHK 05SEP2019 ENRIQUE OCHOA APVD 05SEP2019 ENRIQUE OCHOA	NAME CONNECTOR, RECEPTACLE
MATERIAL SEE NOTE 5	SEE NOTE 4	PRODUCT SPEC APPLICATION SPEC	SIZE A2
CUSTOMER DRAWING		WEIGHT -	SCALE 6:1
		RESTRICTED TO -	SHEET 1 OF 1 REV B

TE Connectivity

Mouser Electronics

Authorized Distributor

Click to View Pricing, Inventory, Delivery & Lifecycle Information:

[TE Connectivity:](#)

[ZPF00000000090168](#)