

THIS DRAWING IS UNPUBLISHED. RELEASED FOR PUBLICATION 20  
 © COPYRIGHT 20 BY - ALL RIGHTS RESERVED.

**T.E. PROPRIETARY AND CONFIDENTIAL**  
 This drawing contains proprietary information that shall not be disclosed, duplicated nor used in whole or in part for any purpose other than to evaluate this drawing.

LOC		DIST		REVISIONS			
P	LTR	DESCRIPTION	DATE	DWN	APVD		
A		REVISED PER E.O. C8206	110510	-	RB		
B		UPDATED PER ECO-14-008850	140611	CB	EA		
C		UPDATED PER ECO-16-000868	160126	MJ	EA		

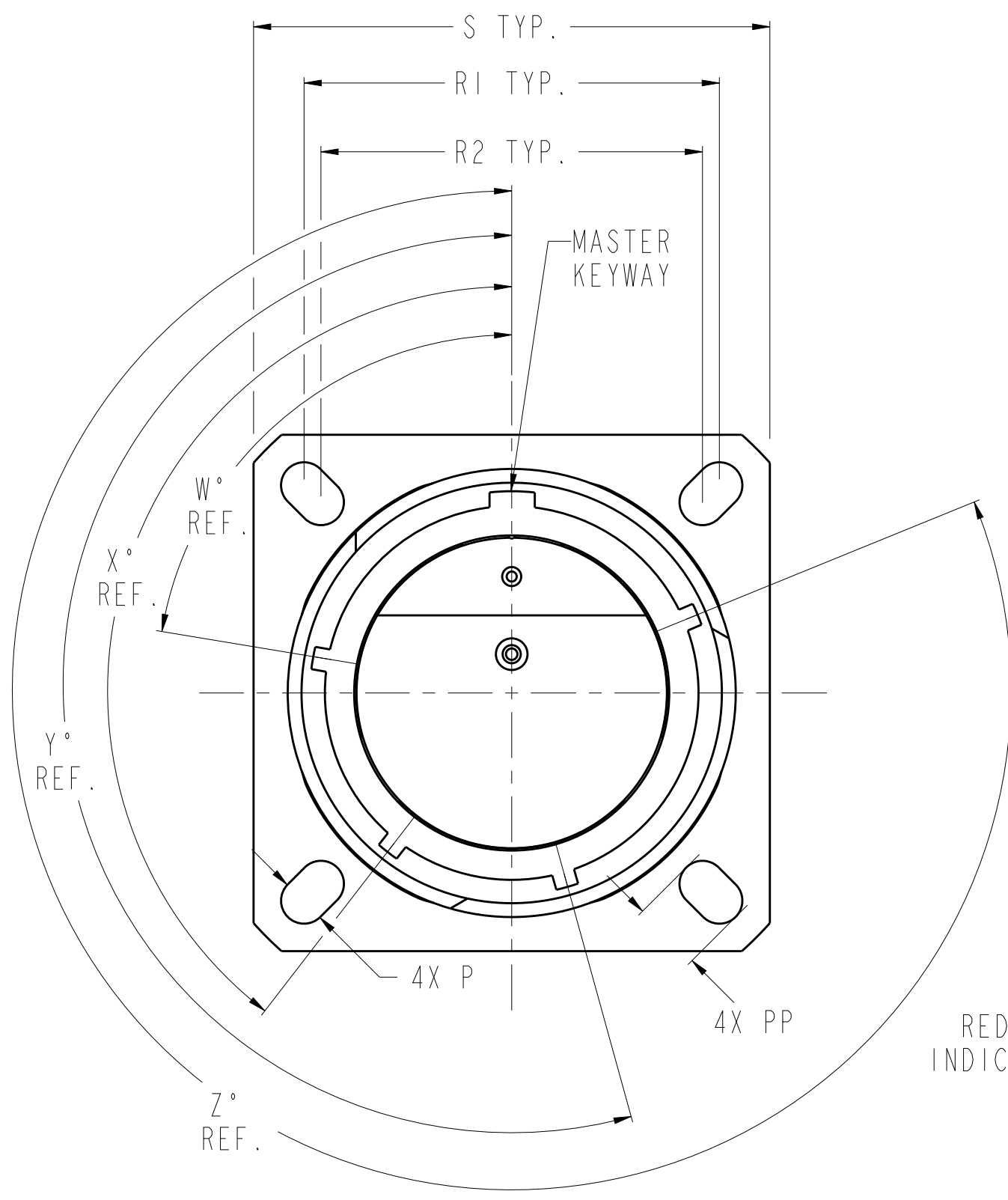

EXAMPLE OF PART NUMBER



5. FOR AVAILABILITY CONSULT FACTORY. (C1)
4. FOR APPLICABLE KEYING DIAGRAM AND PANEL CUTOUT DIMENSIONS, SEE MIL-DTL-38999. FOR AVAILABLE INSERT ARRANGEMENTS, SEE MIL-STD-1560.
3. GENERAL SPECIFICATIONS: THIS CONNECTOR MEETS THE PERFORMANCE AND INTERMATEABILITY REQUIREMENTS OF MIL-DTL-38999, SERIES III.
2. MATERIAL / FINISH: SHELL - ALUMINUM ALLOY / PLATING PER EXAMPLE PART NUMBER DESCRIPTION.  
 RESILIENT INSERTS - SILICONE ELASTOMER  
 PLASTIC INSERTS - THERMOPLASTIC.  
 CONTACTS - COPPER ALLOY / GOLD PLATED.
1. ALL DIMENSIONS ARE IN INCHES UNLESS OTHERWISE SPECIFIED. THREAD CALLOUTS ARE METRIC.

NOTES:

SIZE	KEYING DESIGNATION LETTER	W°	X°	Y°	Z°
9	N	105	140	215	265
	A	102	132	248	320
	B	80	118	230	312
	C	35	140	205	275
	D	64	155	234	304
11, 13 AND 15	N	95	141	208	236
	A	113	156	182	292
	B	90	145	195	252
	C	53	156	220	255
	D	119	146	176	298
17, 19, 21, 23 AND 25	N	80	142	196	293
	A	135	170	200	310
	B	49	169	200	244
	C	66	140	200	257
	D	62	145	180	280
E	79	153	197	272	

PART NUMBER	SIZE	D THREAD	P+.004 -.002	PP+.004 -.002	R1	R2	S±.011	V MAX.	W MAX.
DTS20x09-xxP/Sx	09	M12X1.0-6g 0.100R	.128	.216	.719	.594	.937	.822	.098
DTS20x11-xxP/Sx	11	M15X1.0-6g 0.100R	.128	.194	.812	.719	1.031	.822	.098
DTS20x13-xxP/Sx	13	M18X1.0-6g 0.100R	.128	.194	.906	.812	1.126	.822	.098
DTS20x15-xxP/Sx	15	M22X1.0-6g 0.100R	.128	.173	.969	.906	1.220	.822	.098
DTS20x17-xxP/Sx	17	M25X1.0-6g 0.100R	.128	.194	1.062	.969	1.311	.822	.098
DTS20x19-xxP/Sx	19	M28X1.0-6g 0.100R	.128	.194	1.156	1.062	1.437	.822	.098
DTS20x21-xxP/Sx	21	M31X1.0-6g 0.100R	.128	.194	1.250	1.156	1.563	.791	.126
DTS20x23-xxP/Sx	23	M34X1.0-6g 0.100R	.154	.242	1.375	1.250	1.689	.791	.126
DTS20x25-xxP/Sx	25	M37X1.0-6g 0.100R	.154	.242	1.500	1.375	1.811	.791	.126

THIS DRAWING IS A CONTROLLED DOCUMENT.

DWN: EHAB ALAWNEH 070410  
 CHK: JAMES FRIEDHOF 070523  
 APVD: ALEX RENGLEO 110511

**STE** TE Connectivity

NAME: DTS SQUARE FLANGE ENVELOPE

PRODUCT SPEC: -  
 APPLICATION SPEC: -  
 WEIGHT: -

MATERIAL: SEE NOTE 2  
 FINISH: SEE NOTE 2

SIZE: A2  
 CAGE CODE: -  
 DRAWING NO: C-DTS20xxx-xxP/Sx  
 RESTRICTED TO: -

SCALE: 2.500  
 SHEET 1 OF 1  
 REV C

# Mouser Electronics

Authorized Distributor

Click to View Pricing, Inventory, Delivery & Lifecycle Information:

[TE Connectivity:](#)

[YDTS20T15-97PB6157](#)