

PROPERTY OF DEUTSCH E.C.D.

This drawing contains proprietary information that shall not be disclosed, duplicated, nor used in whole or in part for any purpose other than to evaluate this drawing.

F	AFD57-**-**P/S*	REVISIONS		
		REV	DESCRIPTION	DATE
F		CHANGED PER E.O. C4087 / C4624	7/25/99	M.K.

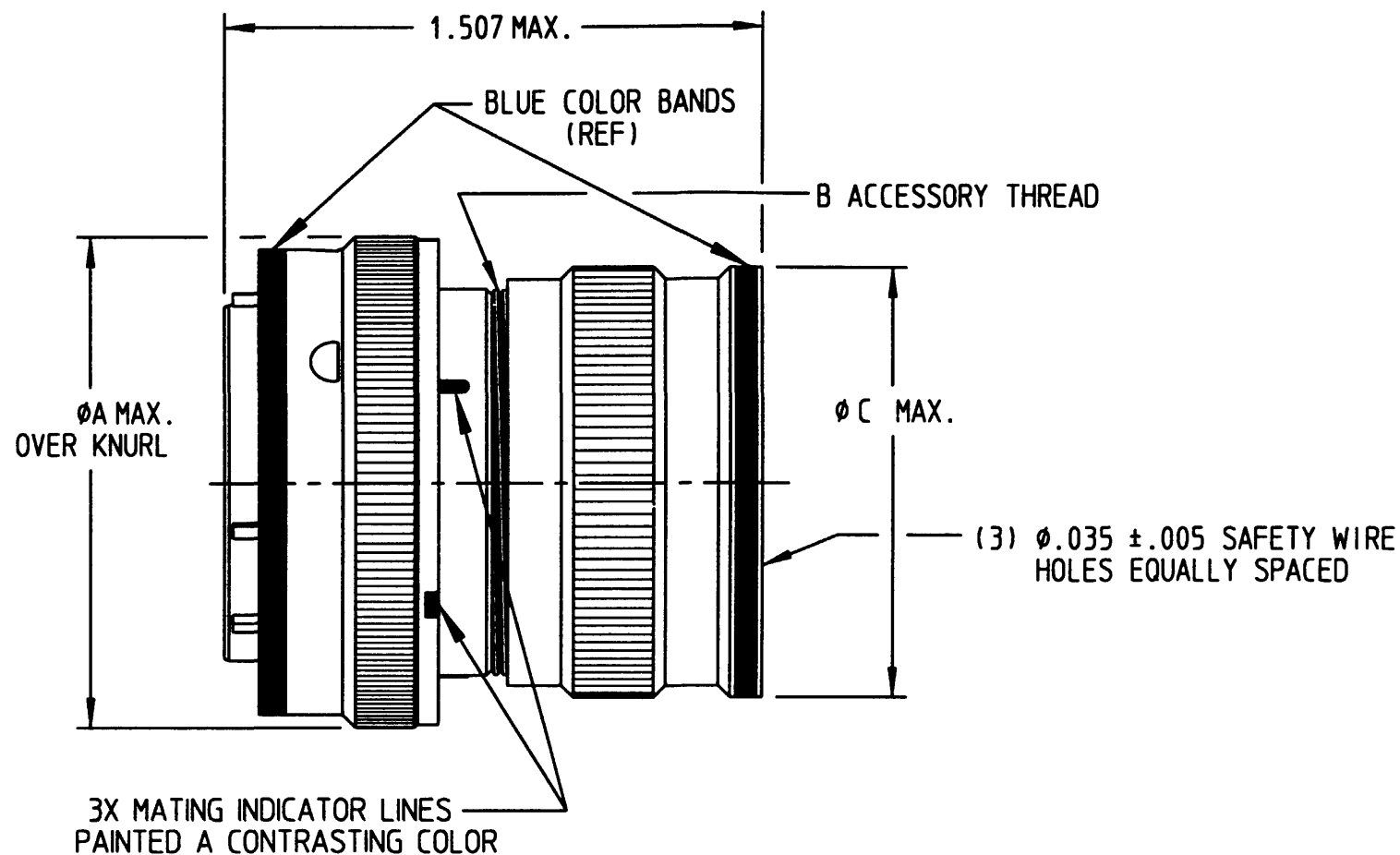
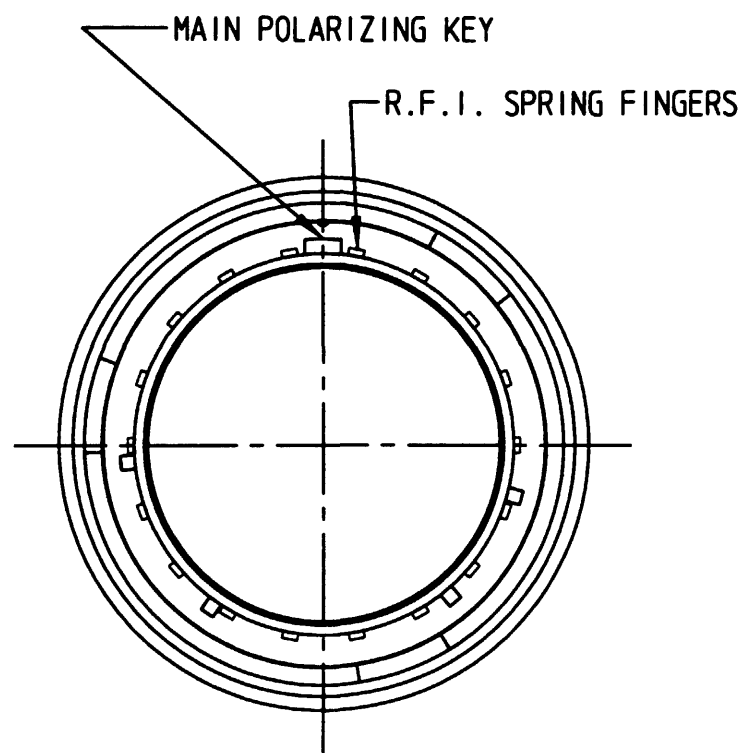

8. DURABILITY 100 CYCLES MINIMUM.
7. FOR CONNECTOR MATING AND UNMATING FORCES SEE TABLE.
6. FOR AVAILABLE CONTACT ARRANGEMENTS AND ALTERNATE INSERT POSITIONS, SEE 38500 B SHEETS IN DBA CATALOG SECTION.
5. THE CONNECTOR IS DESIGNED TO MEET THE PERFORMANCE AND DIMENSIONAL REQUIREMENTS OF MIL-C-26482 CLASS R AND IS SUPPLIED WITH BACKSHELL.
4. FOR BACKSHELL WITH STRAIGHT STRAIN RELIEF OR 90° STRAIN RELIEF, CONSULT FACTORY.
3. CONNECTOR WEIGHTS ARE SHOWN LESS CONTACTS.
2. CONNECTOR FINISH: ELECTROLESS NICKEL PER MIL-C-26074, CLASS 3, GRADE A.
1. DIMENSIONS ARE IN INCHES UNLESS OTHERWISE SPECIFIED.

PART NUMBER	A MAX.	B THREAD	C MAX.	MAX. WEIGHTS IN POUNDS		TORQUE INCH POUNDS MAXIMUM
				PIN	SOC	
AFD57-8-**-**P/S*	.782	.500 -20UNF	.617	.0260	.0271	9.6
AFD57-10-**-**P/S*	.926	.625 -24UNEF	.734	.0359	.0383	12.0
AFD57-12-**-**P/S*	1.043	.750 -20UNEF	.858	.0521	.0554	16.8
AFD57-14-**-**P/S*	1.183	.875 -20UNEF	.984	.0673	.0751	20.4
AFD57-16-**-**P/S*	1.305	1.000 -20UNEF	1.112	.0798	.0883	27.6
AFD57-18-**-**P/S*	1.391	1.0625-18UNEF	1.218	.0951	.1037	31.2
AFD57-20-**-**P/S*	1.531	1.1875-18UNEF	1.345	.1102	.1213	37.2
AFD57-22-**-**P/S*	1.656	1.3125-18UNEF	1.468	.1318	.1463	45.6
AFD57-24-**-**P/S*	1.777	1.4375-18UNEF	1.593	.1471	.1627	45.6

SIGNATURE & DATE	
DR	D.WHITACRE 6/30/94
CHK	JO POWELL 7/6/94
PE	D.WHITACRE 6/30/94
APPD	<i>[Signature]</i> 8/23/00
SCALE	NONE WT _____

CONNECTOR, PLUG
BAYONET COUPLING
MIL-C-26482 TYPE
WITH R.F.I. GROUNDING FINGERS

ENVELOPE

CP	MATL CODE
DEUTSCH ENGINEERED CONNECTING DEVICES 5733 W. Whittier Ave. Hemel, California	
A	AFD57-**-**P/S*
DWG SIZE	CODE 1139 SHEET 1 OF 1

Mouser Electronics

Authorized Distributor

Click to View Pricing, Inventory, Delivery & Lifecycle Information:

[TE Connectivity:](#)

[YAFD57-14-18PNC012](#)