

983-15 KV 7- 12- 03 S N- L *

Connector type

Connector model
A-W-WS-R-RS-K-S-KE-SE-KV-SV-KF-SF
 (W-R-K-KE : plug only)

Shell type
2 square flange receptacle with integral accessory
3 jam-nut receptacle with integral accessory
7 plug with integral accessory

Shell size
08 - 10 - 12 - 14 - 16 - 18 - 20 - 22 - 24 - 28

Arrangements

Contact type
P Male contact
S Female contact

Key orientation
N - 6 - 7 - 8 - 9 - Y

Index for contact
L Connector without contact
Without index Connector with contacts

* special modifications :
 A1499 for KE and SE only
 For other modifications, Consult TE Technical Support

**SHELL TYPE 2 :
 Square Flange Receptacle with Integral Accessory**

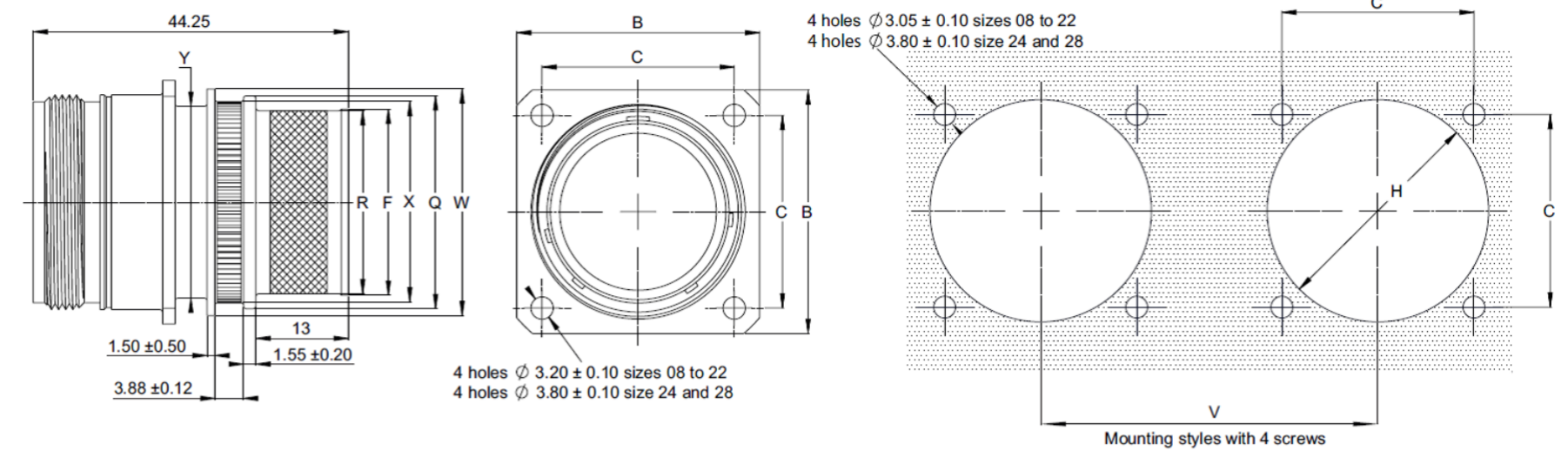

Size	B Max.	C ±0.05	R ±0.10	F ±0.10	Y Max.	X ±0.10	Q ±0.10	W ±0.25	H Min.	V Min.
08	20.75	15.09	11.70	12.10	14.27	17.10	18.70	19.50	15.80	31.70
10	23.93	18.26	14.92	15.32	17.68	18.00	19.60	21.50	18.70	34.90
12	26.32	20.62	17.87	18.27	22.22	20.40	22.00	23.50	23.40	39.60
14	28.71	23.01	21.05	21.45	23.78	24.50	26.10	28.00	24.90	41.25
16	31.88	24.61	24.22	24.62	26.97	27.00	28.60	30.50	28.30	44.45
18	34.24	26.97	25.64	26.04	30.15	28.20	29.80	31.70	31.10	47.35
20	36.63	29.36	28.82	29.22	33.32	32.00	33.60	35.50	34.50	51.90
22	39.80	31.75	32.00	32.40	36.50	35.10	36.70	38.60	37.50	54.10
24	43.39	34.92	35.17	35.57	39.67	40.50	42.10	42.00	40.60	57.25
28	50.93	39.67	41.52	41.92	46.02	45.00	46.60	48.50	48.00	65.25

**SHELL TYPE 3 :
 Jam-Nut Receptacle with Integral Accessory**

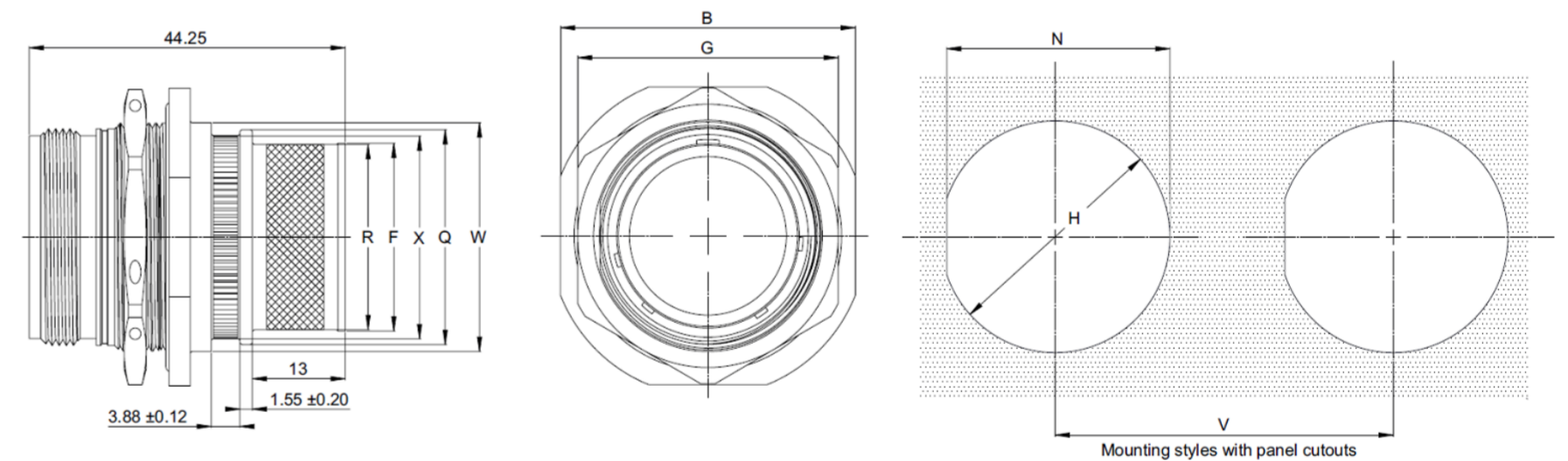

Size	B Max.	G Max.	R ±0.10	F ±0.10	X ±0.10	Q ±0.10	W ±0.25	N O-0.26	H O-0.26	V Min.	Tightening torque of panel nut
08	24.89	12.70	11.70	12.10	17.10	18.70	19.50	15.50	16.26	31.70	7 m.N max.
10	28.04	15.88	14.92	15.32	18.00	19.60	21.50	18.67	19.43	34.90	10 m.N max.
12	32.79	19.05	17.87	18.27	20.40	22.00	23.50	23.42	24.18	39.60	12 m.N max.
14	35.33	22.23	21.05	21.45	24.50	26.10	28.00	25.02	25.78	41.25	15 m.N max.
16	38.51	25.40	24.22	24.62	27.00	28.60	30.50	28.20	28.96	44.45	18 m.N max.
18	41.68	26.97	25.64	26.04	28.20	29.80	31.70	31.25	32.13	47.35	22 m.N max.
20	44.86	30.18	28.82	29.22	32.00	33.60	35.50	34.42	35.31	51.90	25 m.N max.
22	49.63	33.32	32.00	32.40	35.10	36.70	38.60	37.59	38.48	54.10	27 m.N max.
24	52.81	36.53	35.17	35.57	40.50	42.10	42.00	40.77	41.66	57.25	29 m.N max.
28	59.21	44.45	41.52	41.92	45.00	46.60	48.50	47.14	48.01	65.25	30 m.N max.

**SHELL TYPE 7 :
 Plug with Integral Accessory**

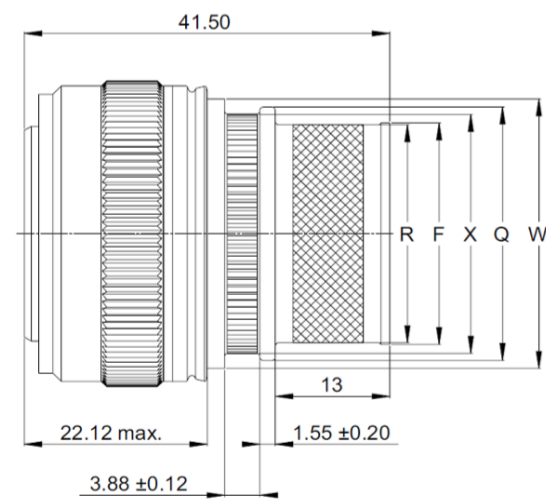

Size	R ±0.10	F ±0.10	X ±0.10	Q ±0.10	W ±0.25
08	11.70	12.10	17.10	18.70	19.50
10	14.92	15.32	18.00	19.60	21.50
12	17.87	18.27	20.40	22.00	23.50
14	21.05	21.45	24.50	26.10	28.00
16	24.22	24.62	27.00	28.60	30.50
18	25.64	26.04	28.20	29.80	31.70
20	28.82	29.22	32.00	33.60	35.50
22	32.00	32.40	35.10	36.70	38.60
24	35.17	35.57	40.50	42.10	42.00
28	41.52	41.92	45.00	46.60	48.50

CHARACTERISTIQUES

- Shell Material : For **W & WS** Connector Models - Aluminum Alloy, Olive Drab Cadmium plated
 For **A** Connector Model - Aluminum Alloy, Black Anodized
 For **R & RS** Connector Models - Aluminum Alloy, Nickel plated
 For **K, S, KE, SE, KV, SV, KF, SF** Connector Models - Stainless steel
- Insert Material : Thermo-setting
- Seal : Silicone
- Contact : Crimp type, removable, gold plating
- Temperature Range : For **W & WS** Connector Models : -65°C to 175°C
 For **A, R, RS, K, S** Connector Models : -65°C to 200°C
 For **KE, SE, KV, SV, KF, SF** Connector Models : -65°C to 260°C cyclique
- Dielectric withstanding Voltage : At sea level - 1500 Vrms 50 Hz mated connectors
 At 15 000 meters altitude - 1000 Vrms 50 Hz mated connectors
 At 30 000 meters altitude - 200 Vrms 50 Hz unmated connectors

DIMENSIONS: MM	TOLERANCES UNLESS OTHERWISE SPECIFIED: 0 PLC ± 1 PLC ±0.05 2 PLC ±0.05 3 PLC ±0.02 4 PLC ±
ANGLES ±°	
SURFACE TEXTURE	

DWN LAKSHMI SUDHA R	MATERIAL -	HEAT TREAT -
CHK RAKESH S		
APVD VINCENT P		
NAME 983 Series Sealed Connectors with Integral Accessory		
SCALE 2:1	SIZE A2	DRAWING NO 983-15X_++
SHEET 1 of 1	REV A	

Mouser Electronics

Authorized Distributor

Click to View Pricing, Inventory, Delivery & Lifecycle Information:

[TE Connectivity:](#)

[ZPF00000000203737](#)