

REVISIONS					
P	LTR	DESCRIPTION	DATE	DWN	APVD
	A1	REVISED	08SEP2020	J.J	W.H

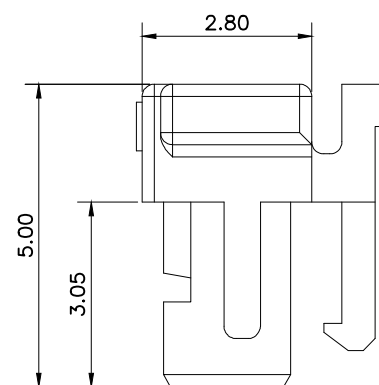
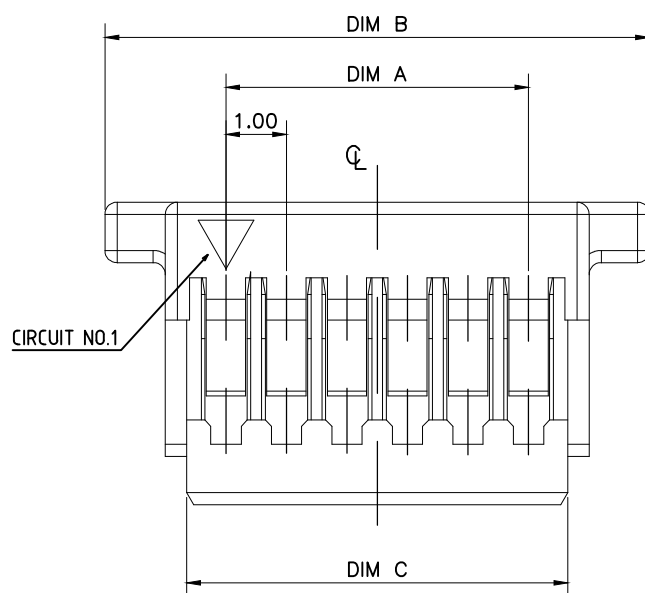
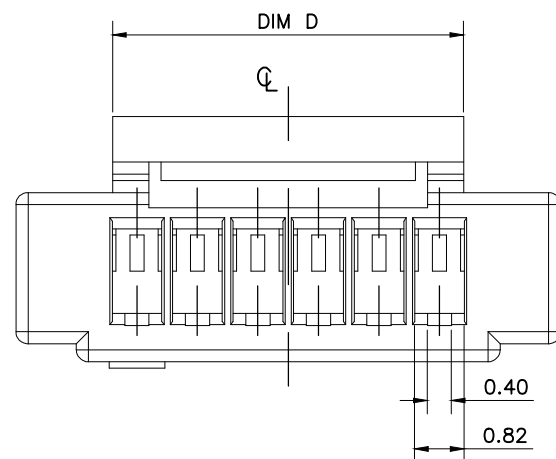

- NOTES:
 1. MATERIAL: HALOGEN FREE PLASTIC, UL94V-0.
 2. CABLE CONTACT: 2367199-1

5.8	15.4	18.0	14.0	15	3-2367198-5	1-2367198-5
	14.4	17.0	13.0	14	3-2367198-4	1-2367198-4
	13.4	16.0	12.0	13	3-2367198-3	1-2367198-3
	12.4	15.0	11.0	12	3-2367198-2	1-2367198-2
	11.4	14.0	10.0	11	3-2367198-1	1-2367198-1
	10.4	13.0	9.0	10	3-2367198-0	1-2367198-0
	9.4	12.0	8.0	9	2-2367198-9	2367198-9
	8.4	11.0	7.0	8	2-2367198-8	2367198-8
	7.4	10.0	6.0	7	2-2367198-7	2367198-7
6.4	9.0	5.0	6	2-2367198-6	2367198-6	
4.8	5.4	8.0	4.0	5	2-2367198-5	2367198-5
3.0	4.4	7.0	3.0	4	2-2367198-4	2367198-4
3.0	3.4	6.0	2.0	3	2-2367198-3	2367198-3
DIM.D	DIM.C	DIM,B	DIM.A	POS.NO	COLOR	
					P/N	

THIS DRAWING IS A CONTROLLED DOCUMENT.		DWN Tommy Qian 18DEC2019	TE Connectivity														
DIMENSIONS: mm		CHK Wenke He				NAME											
TOLERANCES UNLESS OTHERWISE SPECIFIED:		APVD Wenke He	1.0P WT B CABLE HOUSING WITH LATCH														
<table border="0"> <tr> <td>0 PLC</td> <td>± 0.5</td> </tr> <tr> <td>1 PLC</td> <td>± 0.35</td> </tr> <tr> <td>2 PLC</td> <td>± 0.25</td> </tr> <tr> <td>3 PLC</td> <td>± 0.15</td> </tr> <tr> <td>4 PLC</td> <td>± -</td> </tr> <tr> <td>ANGLES</td> <td>± 2°</td> </tr> </table>		0 PLC	± 0.5	1 PLC	± 0.35	2 PLC	± 0.25	3 PLC	± 0.15	4 PLC	± -	ANGLES	± 2°	PRODUCT SPEC 108-115169	RESTRICTED TO		
0 PLC	± 0.5																
1 PLC	± 0.35																
2 PLC	± 0.25																
3 PLC	± 0.15																
4 PLC	± -																
ANGLES	± 2°																
MATERIAL SEE NOTE		FINISH -	APPLICATION SPEC 114-115031	SIZE A3	CAGE CODE 00779	DRAWING NO C-2367198											
CUSTOMER DRAWING			WEIGHT	SCALE N/A	SHEET 1 OF 2	REV A1											

REVISIONS					
P	LTR	DESCRIPTION	DATE	DWN	APVD
	-	SEE SHEET 1	-	-	-

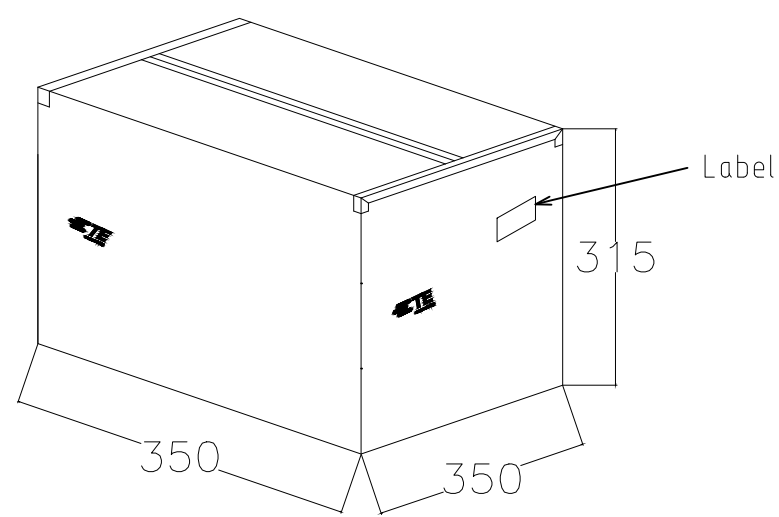
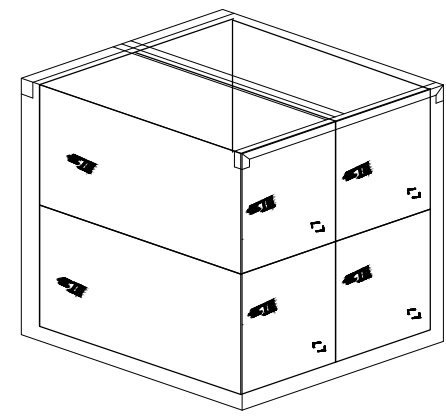
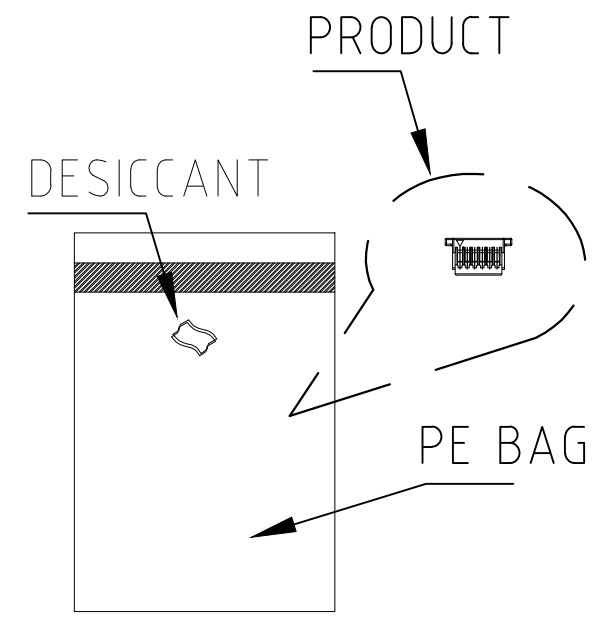
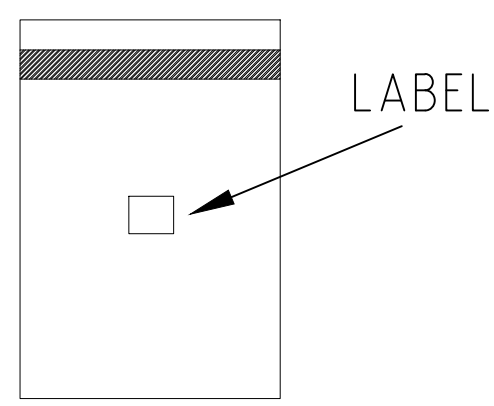
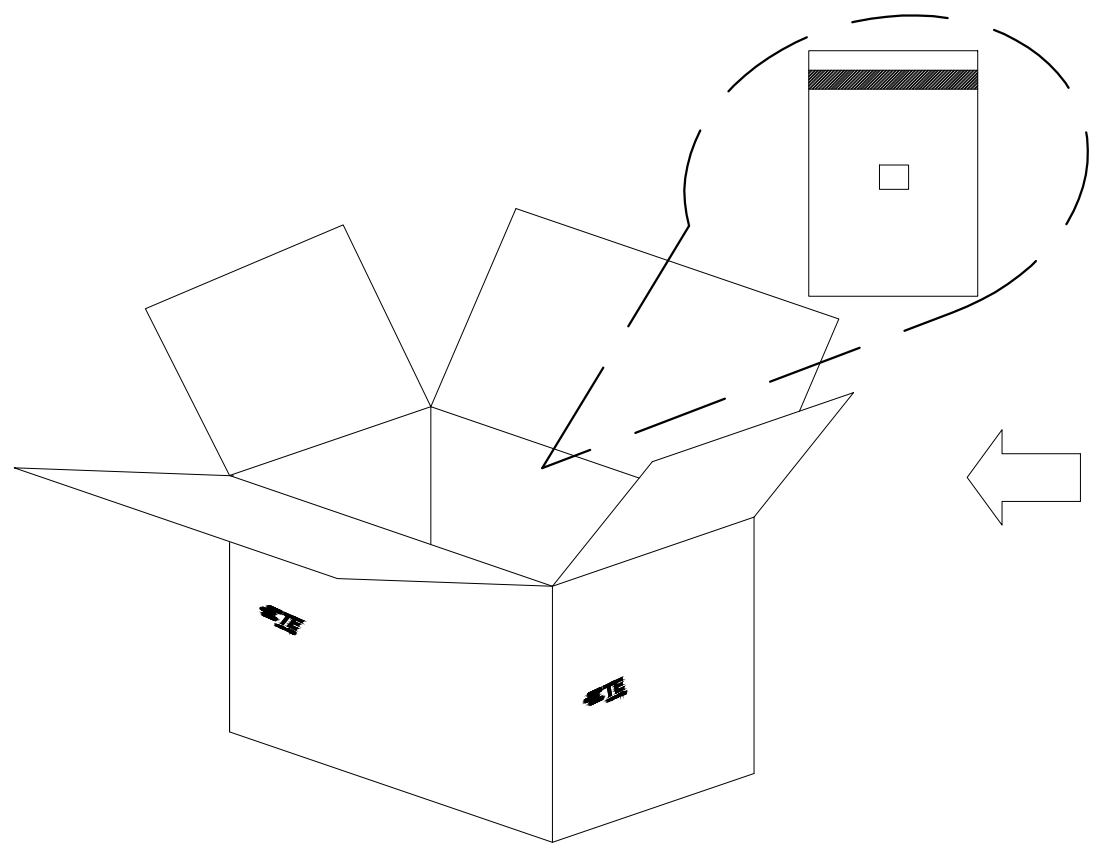

PART NUMBER	PCS/PEG	PCS/CARTON
2-2367198-3	2367198-3	1600
2-2367198-4	2367198-4	1600
2-2367198-5	2367198-5	1600
2-2367198-6	2367198-6	1600
2-2367198-7	2367198-7	1600
2-2367198-8	2367198-8	1600
2-2367198-9	2367198-9	1600
3-2367198-0	1-2367198-0	1600
3-2367198-1	1-2367198-1	1600
3-2367198-2	1-2367198-2	1600
3-2367198-3	1-2367198-3	1600
3-2367198-4	1-2367198-4	1600
3-2367198-5	1-2367198-5	1600

Put 4 small carton into out carton

NOTES:
PACKAGE FOR *-2367198-*

THIS DRAWING IS A CONTROLLED DOCUMENT.		DWN Tommy Qian 18DEC2019	TE Connectivity		
DIMENSIONS: mm		CHK Wenke He			
TOLERANCES UNLESS OTHERWISE SPECIFIED:		APVD Wenke He	1.0P WTB CABLE HOUSING WITH LATCH		
0 PLC ± 0.5 1 PLC ± 0.35 2 PLC ± 0.25 3 PLC ± 0.15 4 PLC ± - ANGLES ± *		PRODUCT SPEC 108-115169	RESTRICTED TO		
MATERIAL SEE NOTE		FINISH -	APPLICATION SPEC 114-115031	SIZE A3	CAGE CODE 00779
CUSTOMER DRAWING			DRAWING NO C-2367198	SCALE N/A	SHEET 2 OF 2
			WEIGHT	REV A1	

Mouser Electronics

Authorized Distributor

Click to View Pricing, Inventory, Delivery & Lifecycle Information:

[TE Connectivity:](#)

[2-2367198-8](#)