

THIS DRAWING IS UNPUBLISHED. RELEASED FOR PUBLICATION 20  
 © COPYRIGHT 20 BY - ALL RIGHTS RESERVED.

REVISIONS				
P	LTR	DESCRIPTION	DATE	APVD
A		RELEASE GOLD PLATED VERSIONS TO PRODUCTION	03SEP2019	AY PS
A1		RELEASE TIN PLATED VERSIONS TO PRODUCTION	14APR2020	AY PS

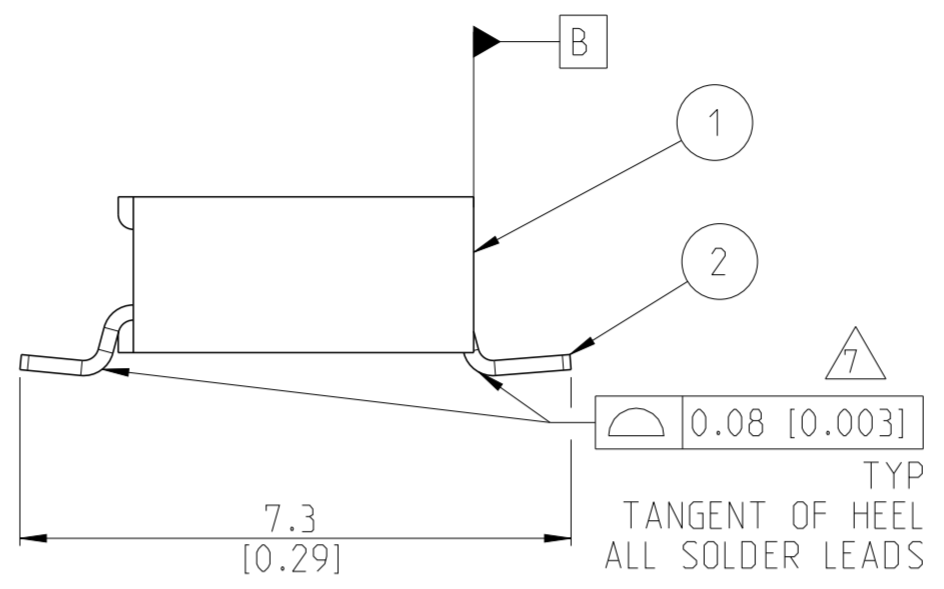
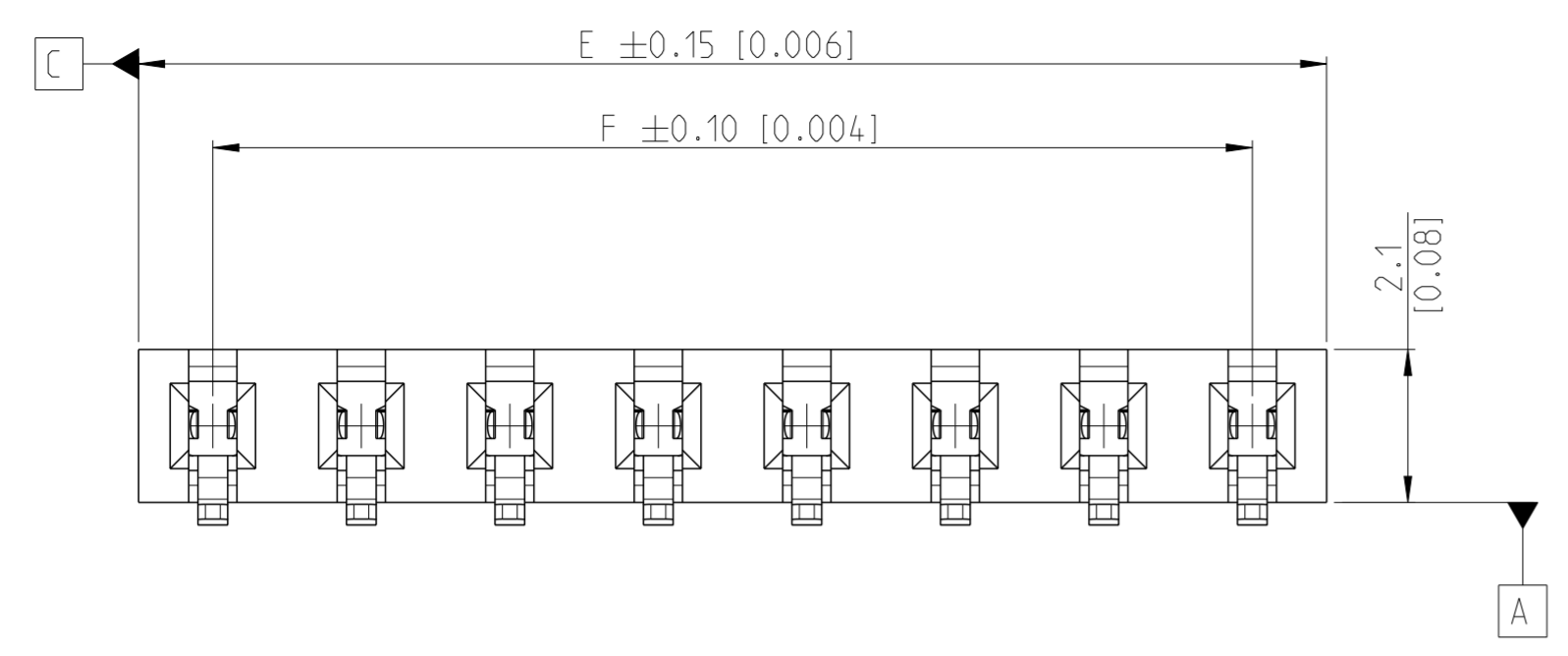

- NOTES:
- 1 MATERIAL:  
HOUSING: LCP, UL94 V0, BLACK  
CONTACT: PHOSPHOR BRONZE, 0.20mm THICK,
  - 2 ALL OVER 3-5µm TIN OVER MIN 1.27µm NICKEL UNDERPLATE
  - 3 CONTACT AREA: MIN 0.1µm GOLD  
SOLDER TAIL: 3-5µm TIN  
UNDERPLATING: MIN 1.27µm NICKEL ALL OVER
  - 4 CONTACT AREA: MIN 0.38µm GOLD  
SOLDER TAIL: 3-5µm TIN  
UNDERPLATING: MIN 1.27µm NICKEL ALL OVER
  - 5 CONTACT AREA: MIN 0.76µm GOLD  
SOLDER TAIL: 3-5µm TIN  
UNDERPLATING: MIN 1.27µm NICKEL ALL OVER
  - 6 N = NO. OF POSITIONS PER CONNECTOR.
  - 7

"N"	FG P/N	CO-PLANARITY
2 TO 10	-2 TO 1- -0	0.08 [0.003]
11 TO 20	1- -1 TO 2- -0	0.10 [0.004]
21 TO 25	2- -1 TO 2- -5	0.15 [0.006]

CONTACT	2
HOUSING	1
DESCRIPTION	ITEM

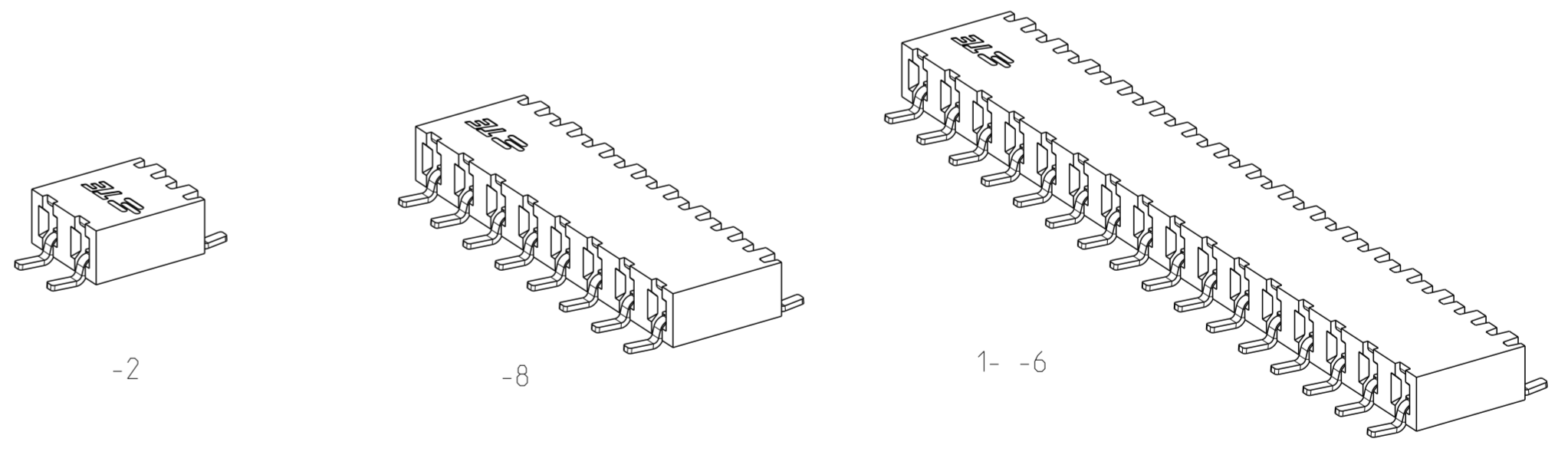
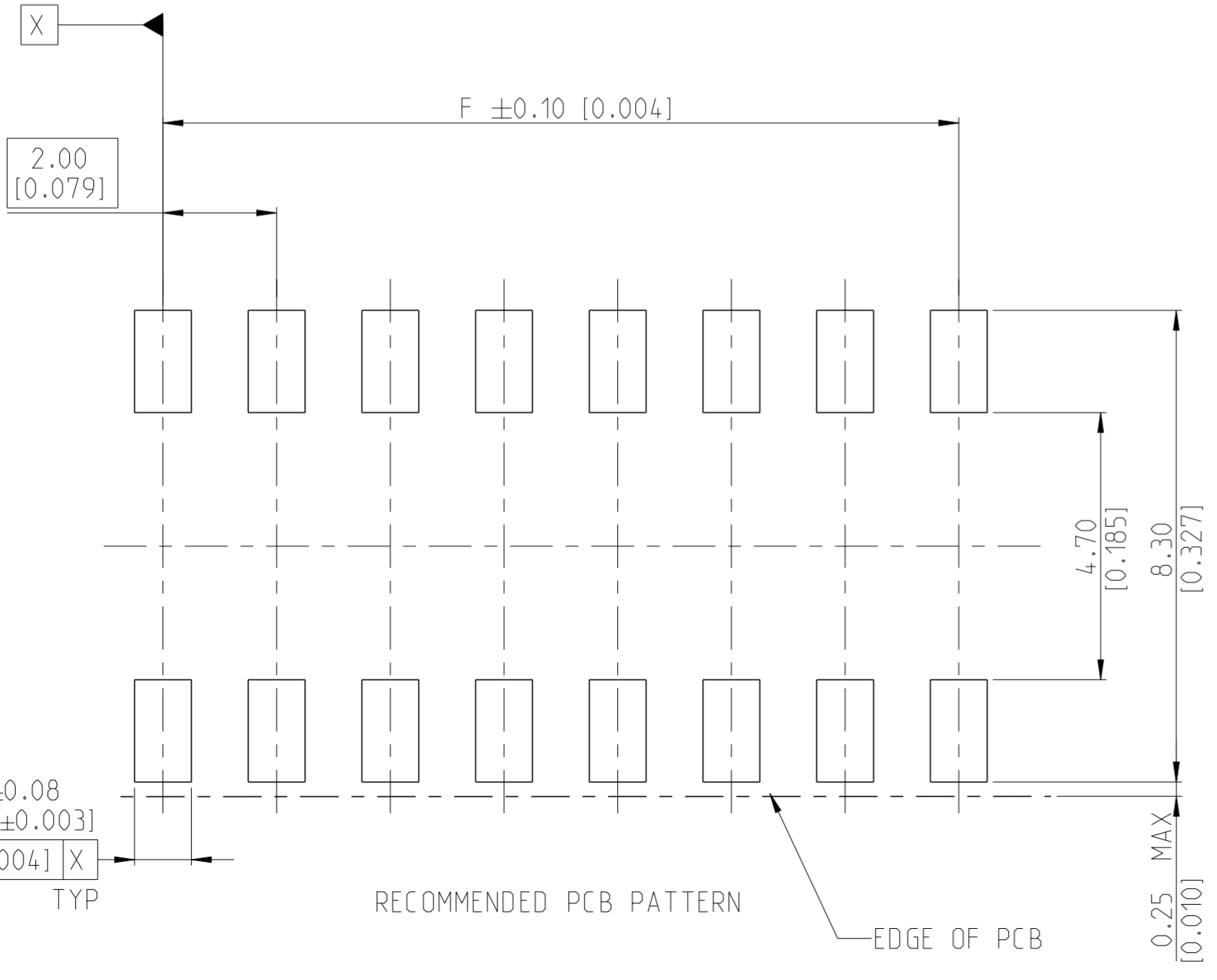
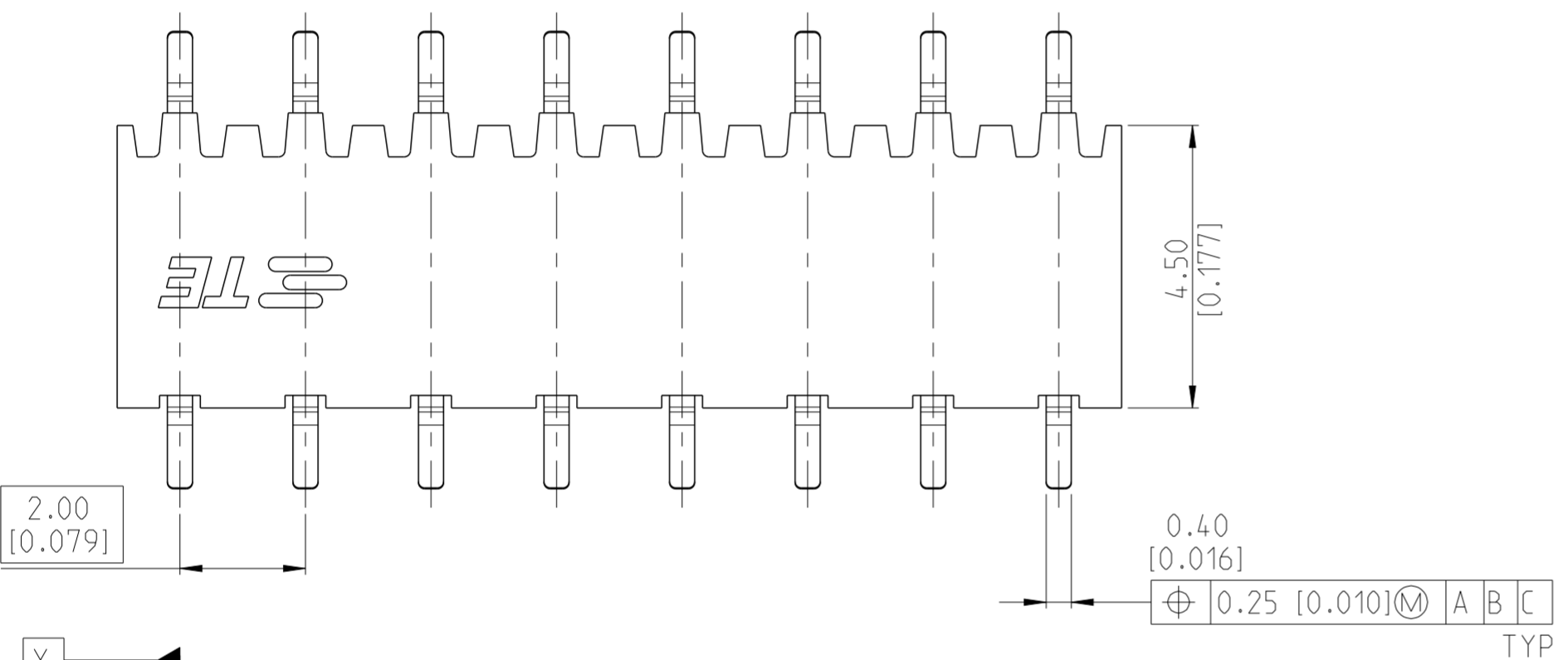



THIS DRAWING IS A CONTROLLED DOCUMENT.

DIMENSIONS: mm [inch]	TOLERANCES UNLESS OTHERWISE SPECIFIED: 0 PLC ± 1 PLC ±0.2 2 PLC ±0.1 [0.008] 3 PLC ± [0.004] 4 PLC ± ANGLES ±2°	DWN 27NOV2017 SOURAV DAS	TE Connectivity
		CHK 26NOV2018 SHARATH S	
MATERIAL SEE NOTES	FINISH SEE NOTES	APVD 26NOV2018 PRASHANTH S	NAME AMPMODU 2mm BtB RECEPTACLE SINGLE ROW, HORIZONTAL SMD
		PRODUCT SPEC 108-64040	SIZE A2
CUSTOMER DRAWING		APPLICATION SPEC 114-32186	CAGE CODE 00779
		WEIGHT -	DRAWING NO C-2307724
		SCALE 10:1	RESTRICTED TO -
		SHEET 1 OF 2	REV A1

THIS DRAWING IS UNPUBLISHED. RELEASED FOR PUBLICATION 20  
 © COPYRIGHT 20 BY - ALL RIGHTS RESERVED.

REVISIONS				
P	LTR	DESCRIPTION	DATE	APVD
-		SEE SHEET 1	-	-

MATING SIDE PLATING (FINISH)	BTB RECEPTACLE BASE NUMBERS	
	TAPE & REEL PKG W/O CAP	TUBE PKG W/O CAP
TIN 	2307724	2314943
GOLD FLASH 0.1µm 	2307725	2314944
GOLD 0.38µm 	2307726	2314945
GOLD 0.76µm 	2307727	2314946

48	50	25	2- -5
46	48	24	2- -4
44	46	23	2- -3
42	44	22	2- -2
40	42	21	2- -1
38	40	20	2- -0
36	38	19	1- -9
34	36	18	1- -8
32	34	17	1- -7
30	32	16	1- -6
28	30	15	1- -5
26	28	14	1- -4
24	26	13	1- -3
22	24	12	1- -2
20	22	11	1- -1
18	20	10	1- -0
16	18	9	-9
14	16	8	-8
12	14	7	-7
10	12	6	-6
8	10	5	-5
6	8	4	-4
4	6	3	-3
2	4	2	-2
DIM "F"	DIM "E"	N	FG PN

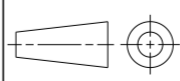
THIS DRAWING IS A CONTROLLED DOCUMENT.		DWN 27NOV2017 SOURAV DAS	 TE Connectivity		
		CHK 26NOV2018 SHARATH S			
DIMENSIONS: mm [inch]		APVD 26NOV2018 PRASHANTH S	NAME AMPMODU 2mm BTB RECEPTACLE SINGLE ROW, HORIZONTAL SMD		
		PRODUCT SPEC 108-64040	RESTRICTED TO		
TOLERANCES UNLESS OTHERWISE SPECIFIED: 0 PLC ± 1 PLC ±0.2 2 PLC ±0.1 [0.008] 3 PLC ± [0.004] 4 PLC ± ANGLES ±2°		APPLICATION SPEC 114-32186	SIZE A2	CAGE CODE 100779	DRAWING NO C-2307724
MATERIAL SEE NOTES		WEIGHT -	SCALE 10:1 SHEET 2 OF 2 REV A1		
		CUSTOMER DRAWING			

# Mouser Electronics

Authorized Distributor

Click to View Pricing, Inventory, Delivery & Lifecycle Information:

[TE Connectivity:](#)

[1-2307725-3](#)