

REVISIONS				
P	LTR	DESCRIPTION	DATE	APVD
C4		NOTES CORRECTED AND PART STATUS UPDATED	06APR2018	RK PS
C5		3-1546105-4 PART OBSOLETE	27AUG2020	DV PS

- NOTES:
- MATERIALS AND FINISH  
HOUSING: PA 6-6, UL 94-V0, COLOR: GREEN.  
CLAMP: BRASS, NICKEL PLATED.  
CONTACT SPRING : PHOSPHOR BRONZE, FINISH: SEE TABLE.  
CLAMPING SCREW: M3, BRASS, NICKEL PLATED.
  - MECHANICAL  
WIRE STRIPPING LENGTH : 6.0-7.5 mm  
RECOMMENDED TIGHTENING TORQUE FOR SCREW : 0.5 Nm.
  - ELECTRICAL  
WIRE RANGE : 12-30 AWG  
MAX. VOLTAGE : 300 V  
MAX CURRENT : 15 A  
CONTACT RESISTANCE : <15 m Ohm  
INSULATION RESISTANCE : >1000 M Ohm (500V DC)
  - INK MARKING: WHITE COLOR.
- $\triangle$  TOLERANCE NOT CUMULATIVE.

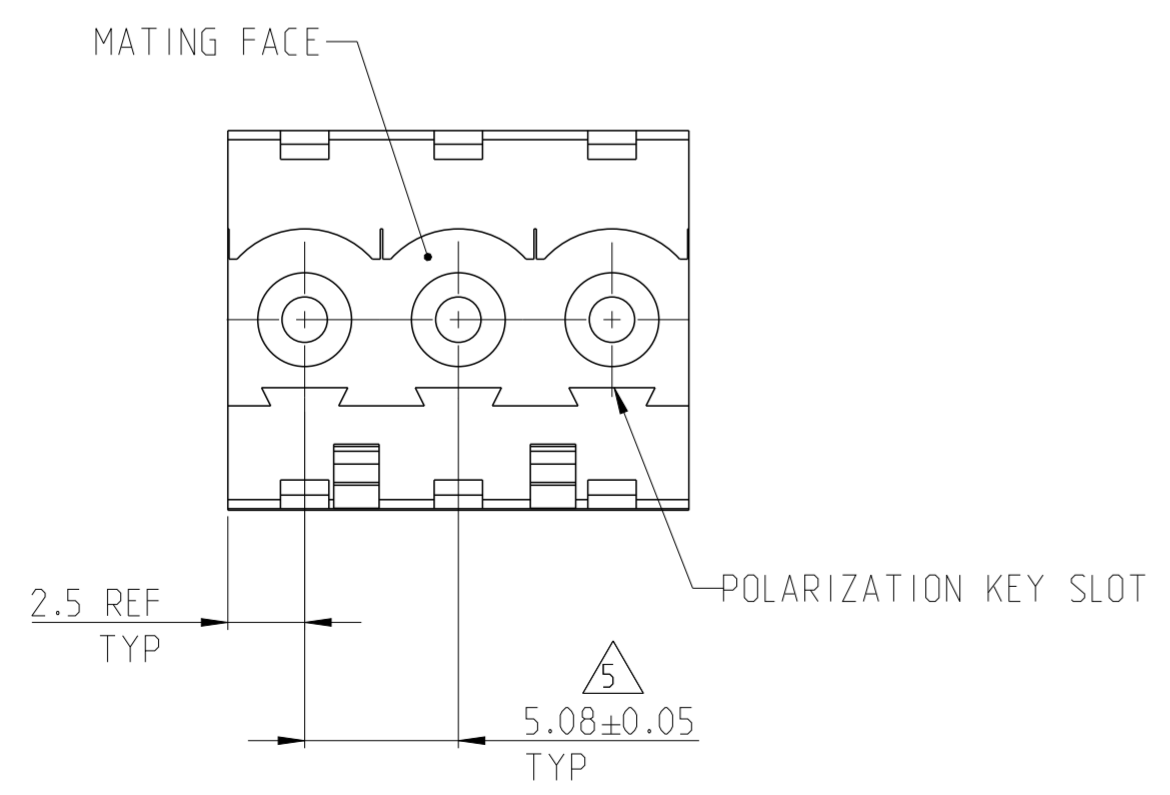
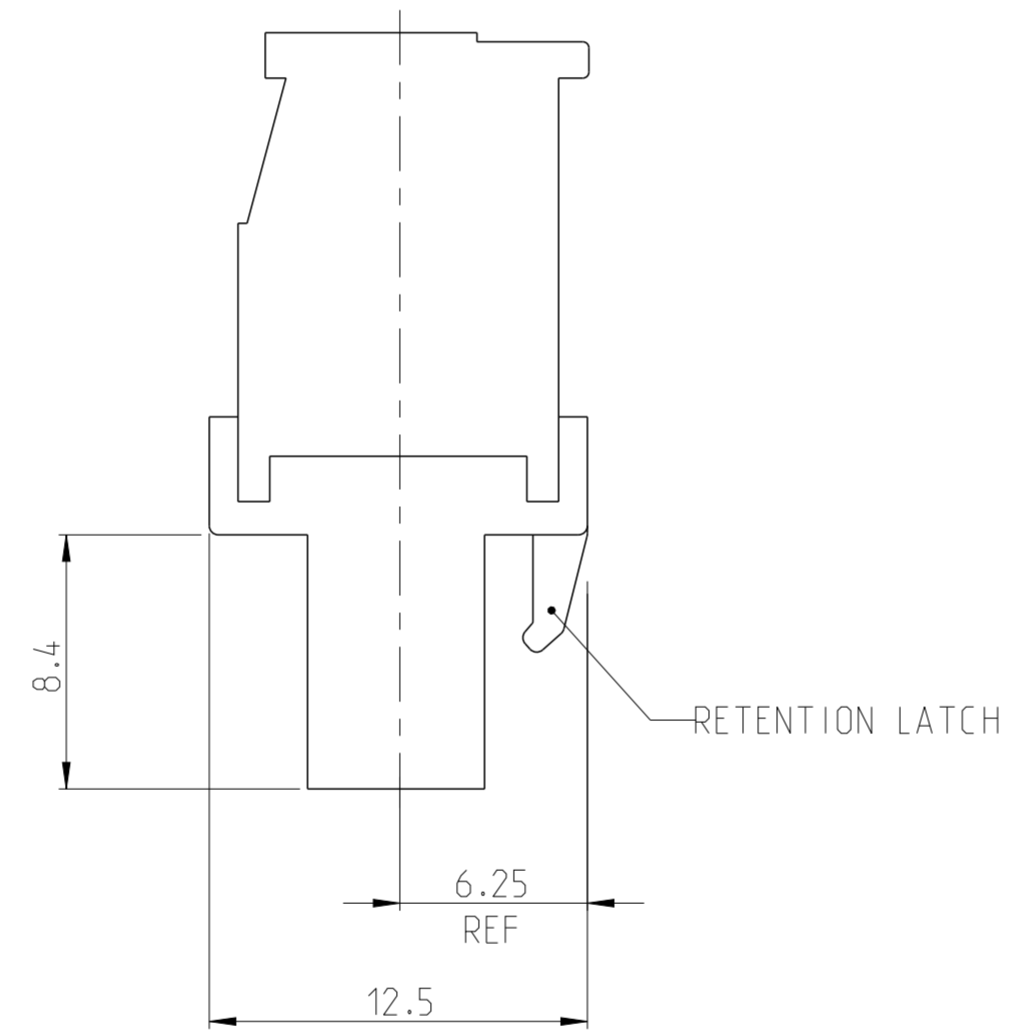
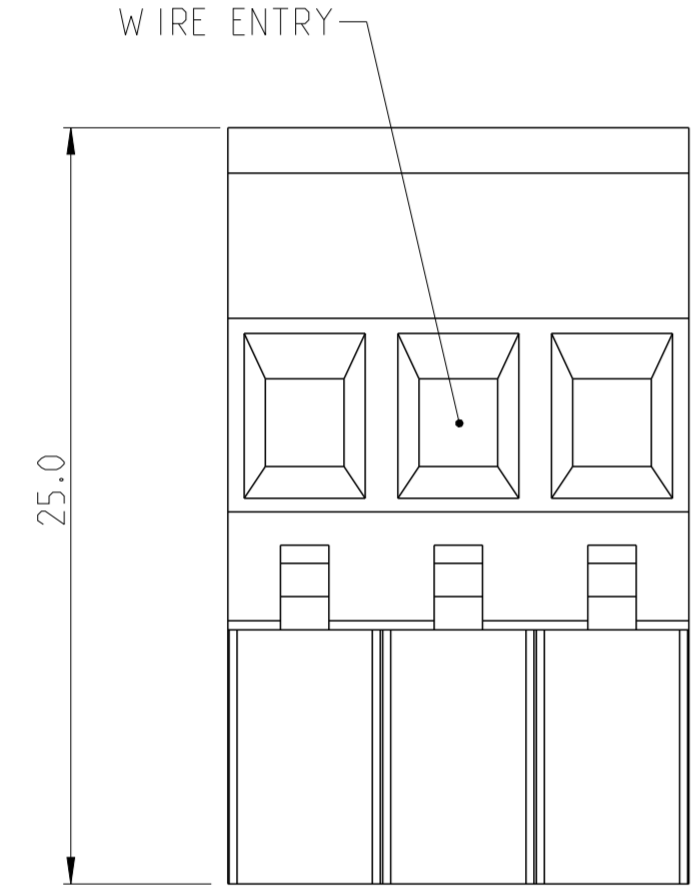
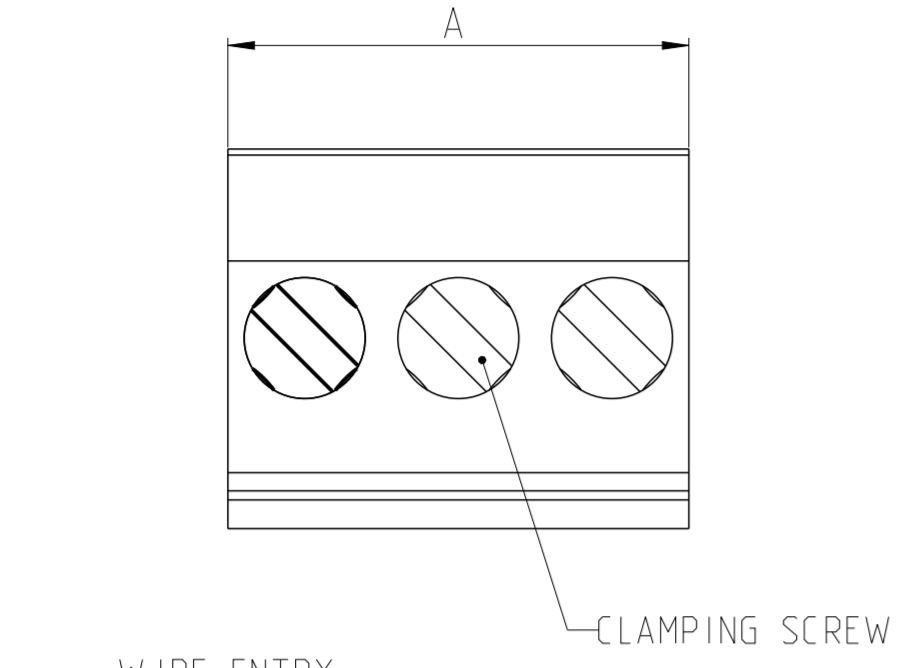

OBSOLETE	SEE DETAIL Z	TIN	20.32	4	5-1546105-4
OBSOLETE	SEE DETAIL X	TIN	60.96	12	6-1546105-0
OBSOLETE	-	.762 μm GOLD	50.80	10	5-1546105-9
OBSOLETE	-	.762 μm GOLD	40.64	8	5-1546105-8
OBSOLETE	-	.762 μm GOLD	35.56	7	5-1546105-7
OBSOLETE	SEE DETAIL W	TIN	60.96	12	5-1546105-6
OBSOLETE	SEE DETAIL V	TIN	76.20	15	5-1546105-5
OBSOLETE	SEE DETAIL U	TIN	45.72	9	4-1546105-9
OBSOLETE	SEE DETAIL T	TIN	40.64	8	4-1546105-8
OBSOLETE	SEE DETAIL S	TIN	30.48	6	4-1546105-6
OBSOLETE	SEE DETAIL R	TIN	20.32	4	4-1546105-4
OBSOLETE	SEE DETAIL P	TIN	50.80	10	4-1546105-0
OBSOLETE	SEE DETAIL N	TIN	30.48	6	3-1546105-6
OBSOLETE	SEE DETAIL M	TIN	25.40	5	3-1546105-5
OBSOLETE	SEE DETAIL L	TIN	20.32	4	3-1546105-4
OBSOLETE	SEE DETAIL K	TIN	66.04	13	3-1546105-3
OBSOLETE	SEE DETAIL J	TIN	50.80	10	3-1546105-0
-	-	TIN	127.00	25	2-1546105-5
-	-	TIN	121.92	24	2-1546105-4
-	-	TIN	116.84	23	2-1546105-3
-	-	TIN	111.76	22	2-1546105-2
-	-	TIN	106.68	21	2-1546105-1
-	-	TIN	101.60	20	2-1546105-0
-	-	TIN	96.52	19	1-1546105-9
-	-	TIN	91.44	18	1-1546105-8
-	-	TIN	86.36	17	1-1546105-7
-	-	TIN	81.28	16	1-1546105-6
-	-	TIN	76.20	15	1-1546105-5
-	-	TIN	71.12	14	1-1546105-4
-	-	TIN	66.04	13	1-1546105-3
-	-	TIN	60.96	12	1-1546105-2
-	-	TIN	55.88	11	1-1546105-1
-	-	TIN	50.80	10	1-1546105-0
-	-	TIN	45.72	9	1546105-9
-	-	TIN	40.64	8	1546105-8
-	-	TIN	35.56	7	1546105-7
-	-	TIN	30.48	6	1546105-6
-	-	TIN	25.40	5	1546105-5
-	-	TIN	20.32	4	1546105-4
-	-	TIN	15.24	3	1546105-3
-	-	TIN	10.16	2	1546105-2
MARKING	CONTACT FINISH	A	NO OF POSN	PART NUMBER	

THIS DRAWING IS A CONTROLLED DOCUMENT.

DWN S.WELDON 03SEP2002  
CHK C.RICHARD 03SEP2002  
APVD C.RICHARD 03SEP2002

**STE** TE Connectivity

NAME: TERMINAL BLOCK VERTICAL PLUG  
STACKING LEFT HAND  
5.08mm PITCH

SIZE: A2 CAGE CODE: 00779 DRAWING NO: C-1546105 RESTRICTED TO: 1 OF 2 REV: C5

MATERIAL: SEE NOTES TOLERANCES UNLESS OTHERWISE SPECIFIED: SEE NOTES

0 PLC ±  
1 PLC ±0.3  
2 PLC ±0.25  
3 PLC ±  
4 PLC ±

ANGLES ±2°  
FINISH

APVD C.RICHARD 03SEP2002  
PRODUCT SPEC  
APPLICATION SPEC  
WEIGHT

CUSTOMER DRAWING SCALE: 4:1 SHEET 1 OF 2 REV: C5

REVISIONS

P	LTR	DESCRIPTION	DATE	DWN	APVD
-		SEE SHEET 1	-	-	-

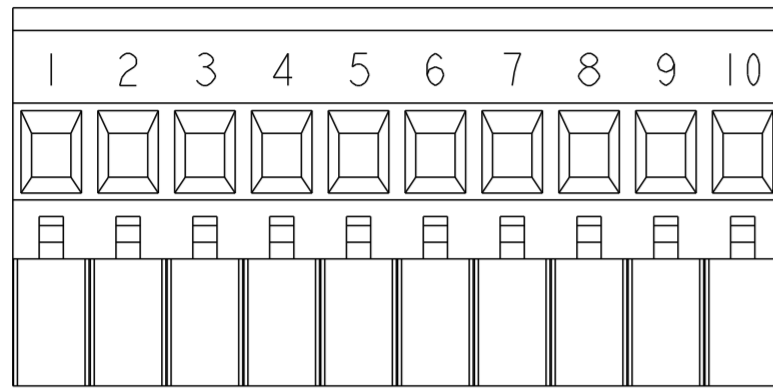

DETAIL J  
SCALE 2:1

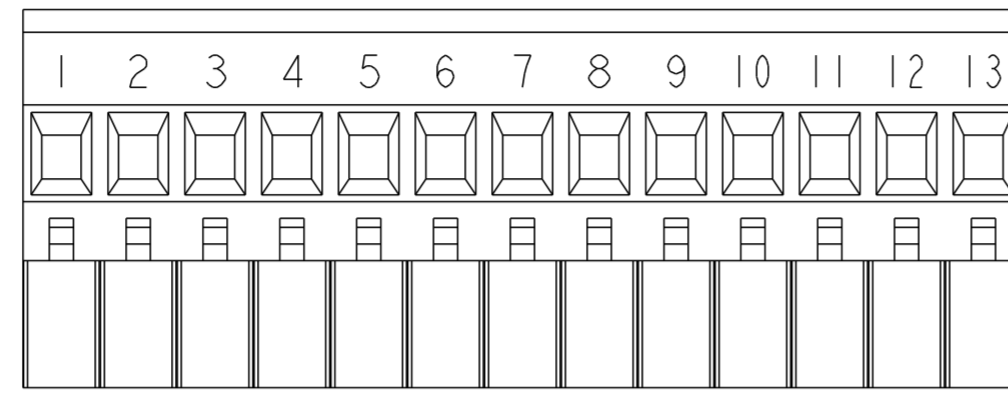

DETAIL K  
SCALE 2:1

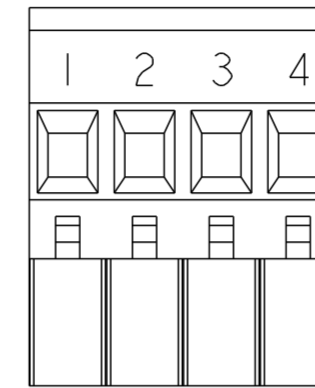

DETAIL L  
SCALE 2:1

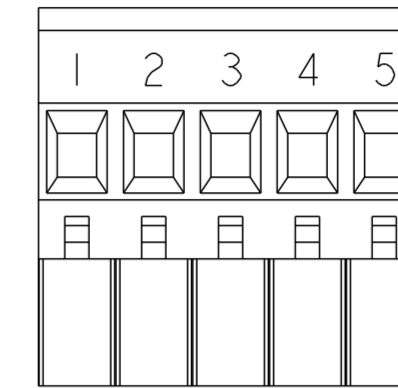

DETAIL M  
SCALE 2:1

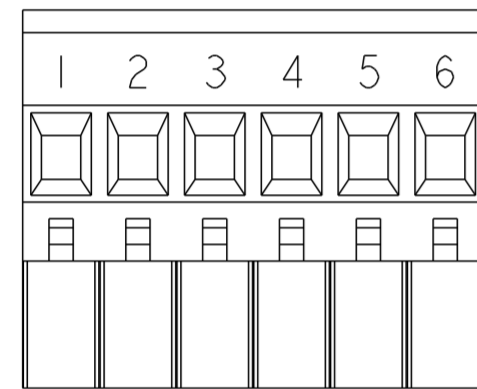

DETAIL N  
SCALE 2:1

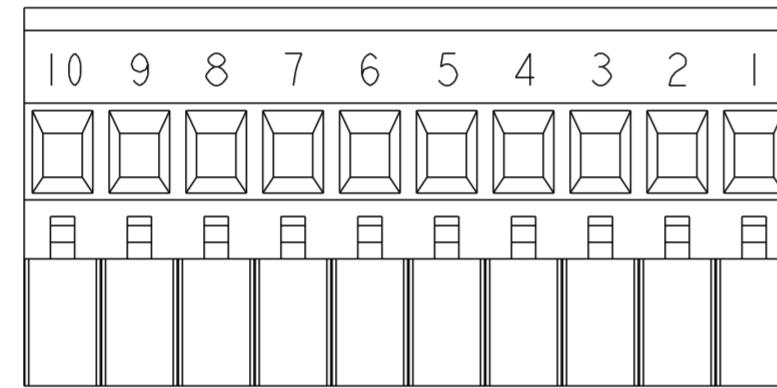

DETAIL P  
SCALE 2:1

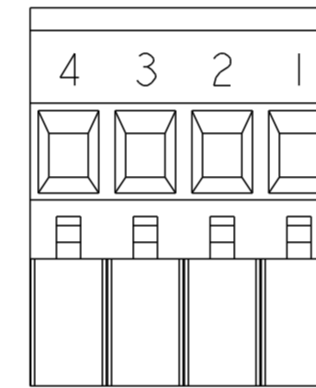

DETAIL R  
SCALE 2:1

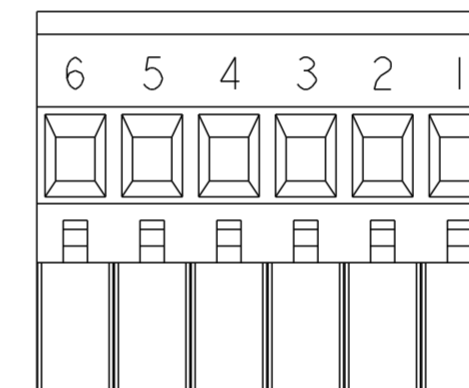

DETAIL S  
SCALE 2:1

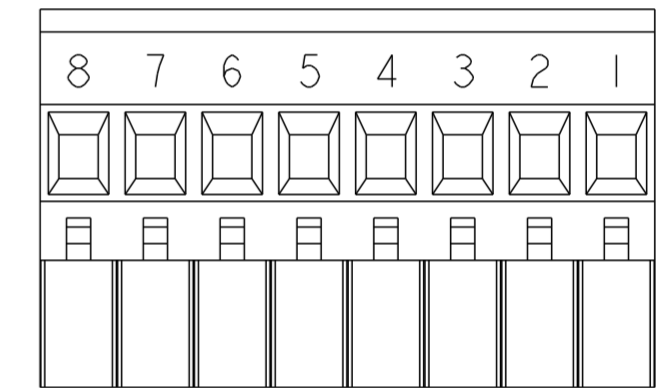

DETAIL T  
SCALE 2:1

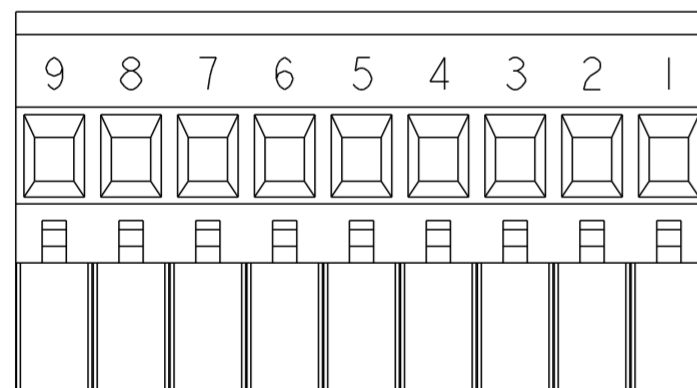

DETAIL U  
SCALE 2:1

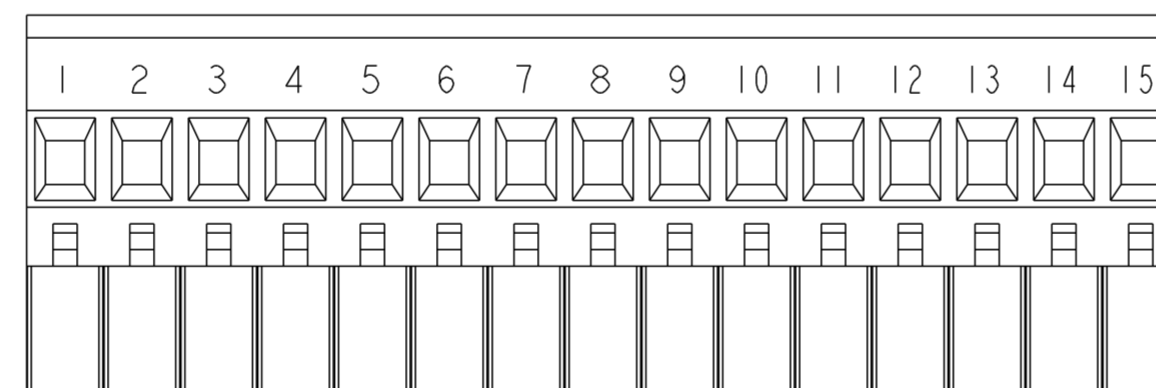

DETAIL V  
SCALE 2:1

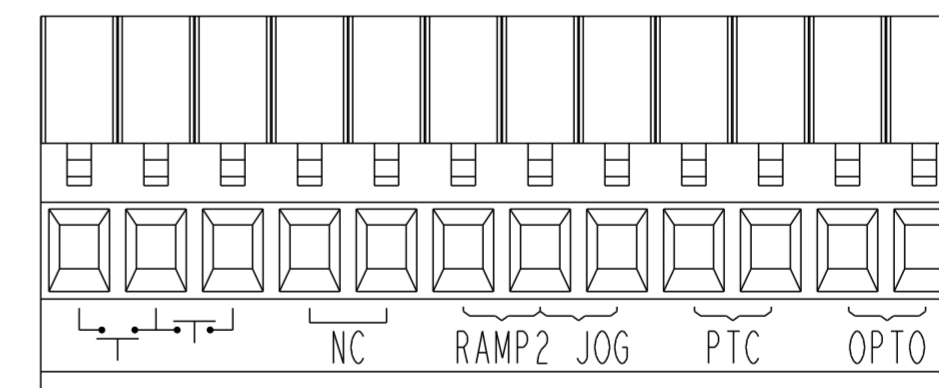

DETAIL W  
SCALE 2:1

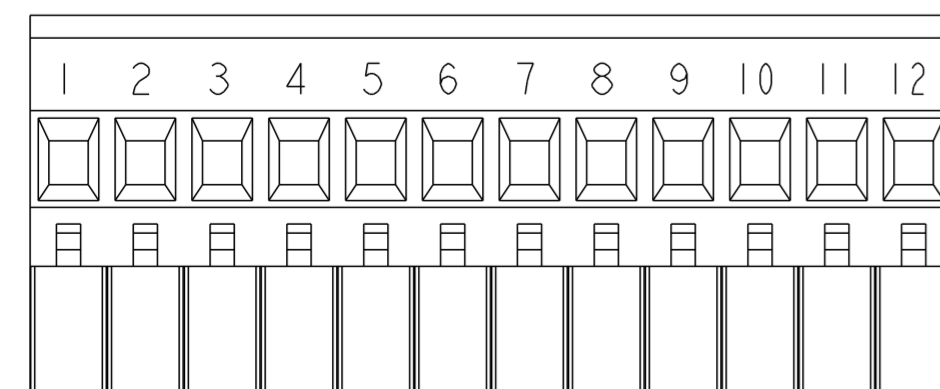

DETAIL X  
SCALE 2:1

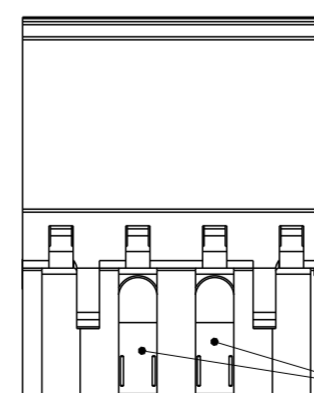

DETAIL Z  
SCALE 2:1

CODING KEYS

THIS DRAWING IS A CONTROLLED DOCUMENT.		DWN S. WELDON 03SEP2002	TE Connectivity	
DIMENSIONS: mm		CHK C. RICHARD 03SEP2002		
TOLERANCES UNLESS OTHERWISE SPECIFIED: 0 PLC ± 1 PLC ±0.3 2 PLC ±0.25 3 PLC ± 4 PLC ± ANGLES ±2° FINISH		APVD C. RICHARD 03SEP2002	NAME TERMINAL BLOCK VERTICAL PLUG STACKING LEFT HAND 5.08mm PITCH	
MATERIAL SEE NOTES		PRODUCT SPEC -	SIZE A2	CAGE CODE 00779
		APPLICATION SPEC -	DRAWING NO C-1546105	RESTRICTED TO
		WEIGHT -	SCALE 3:1	SHEET 2 OF 2
		CUSTOMER DRAWING	REV C5	

# Mouser Electronics

Authorized Distributor

Click to View Pricing, Inventory, Delivery & Lifecycle Information:

[TE Connectivity:](#)

[1-1546105-5](#)