

REVISIONS					
P	LTR	DESCRIPTION	DATE	DRN	APVD
U		REVISED PER ECO-20-001327	05JUN2020	SB	JO

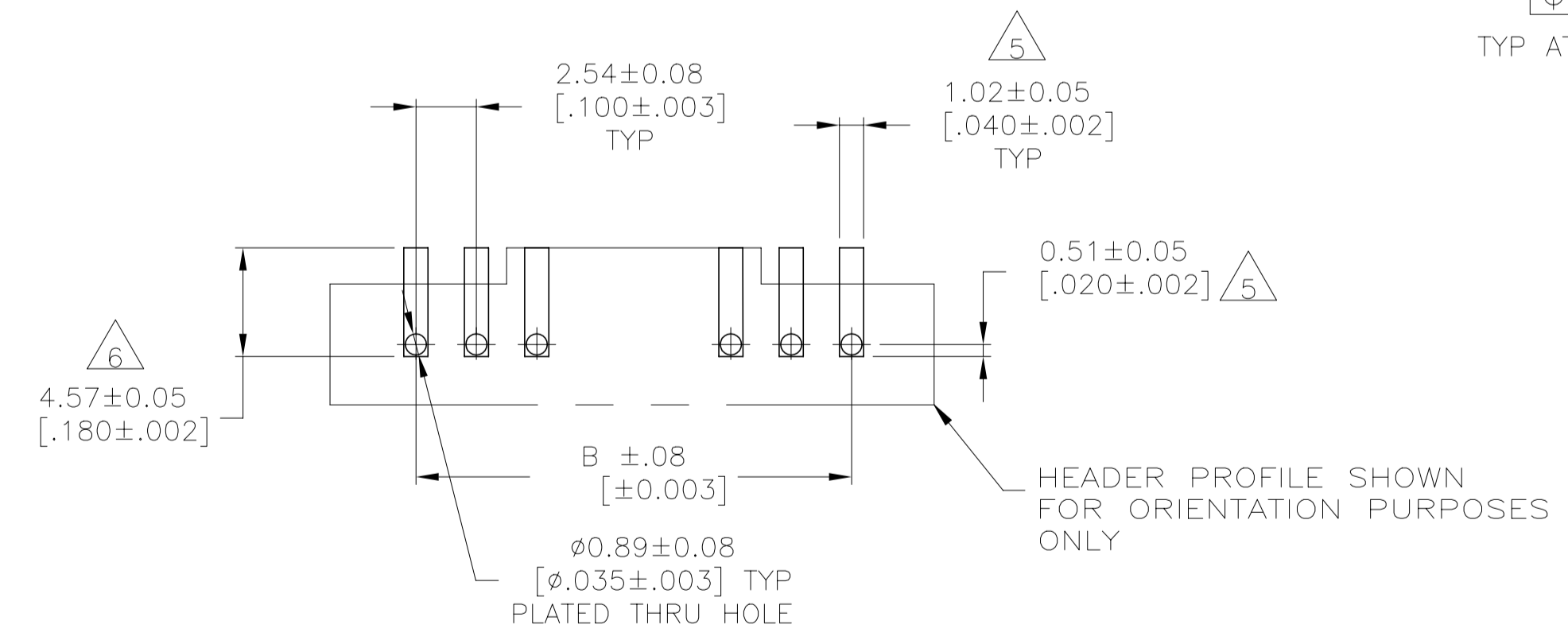
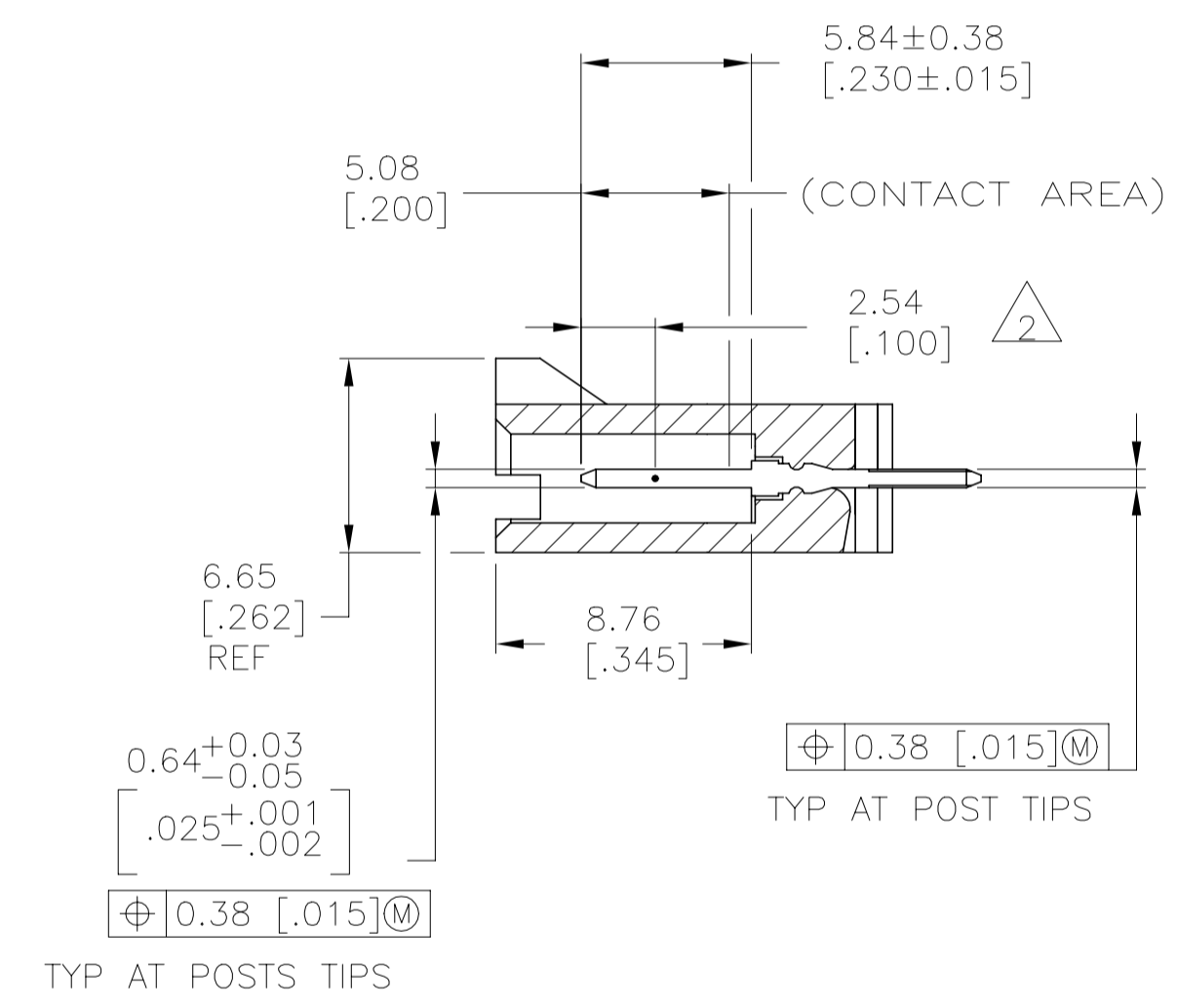
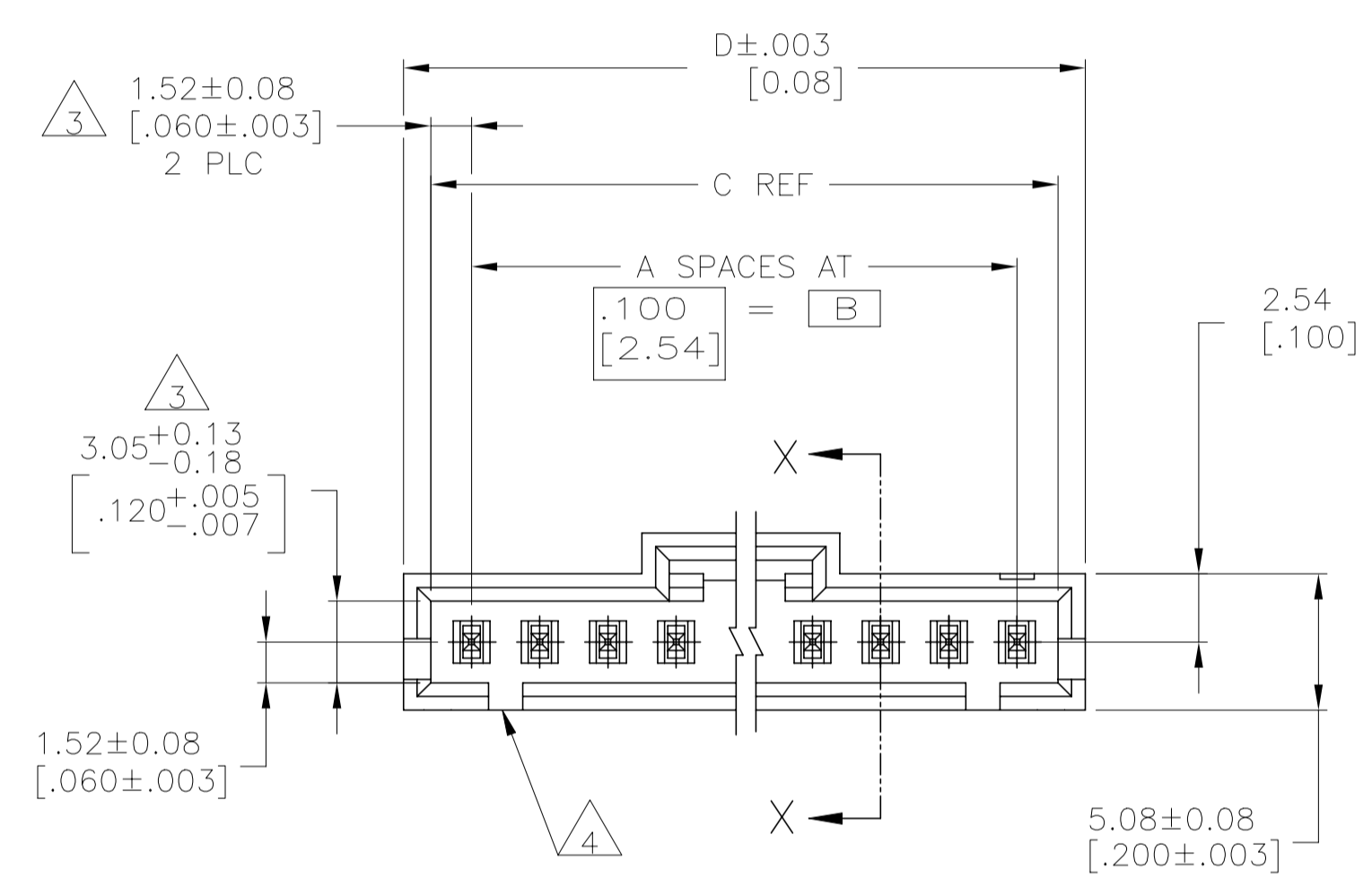
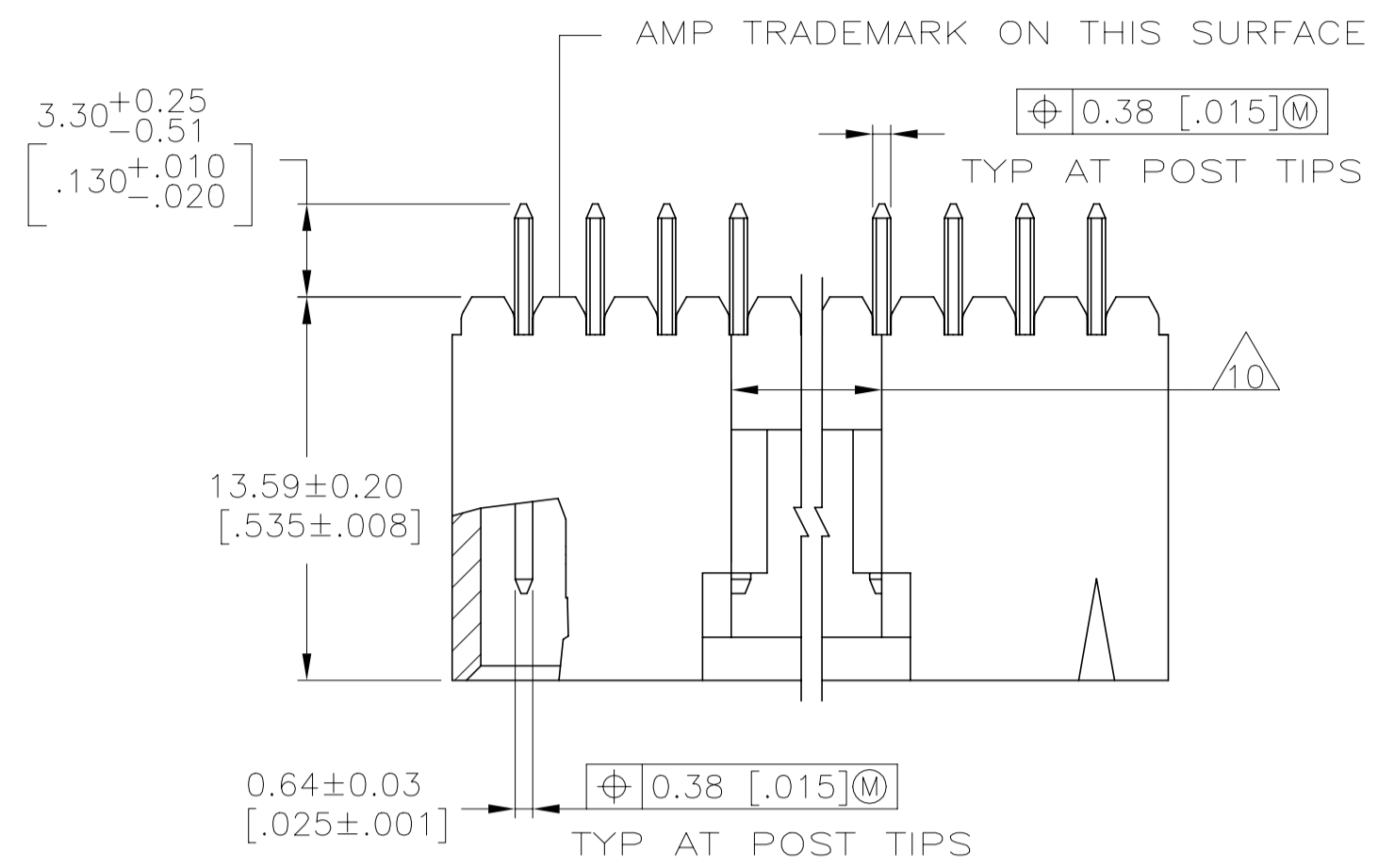

RECOMMENDED PC BOARD MOUNTING DIMENSIONS
RECOMMENDED STENCIL THICKNESS = 0.25 [0.010]

- 1 .000015[0.000381]GOLD IN THE CONTACT AREA, .000100-.000200[0.00254-0.00508] MATTE TIN-LEAD ON THE SOLDER TAIL, ALL OVER .000050[0.00127] NICKEL.
- 2 POINT OF MEASUREMENT FOR PLATING THICKNESS
- 3 THE NOTED DIMENSIONS APPLY FROM THE BASIC DIMENSION LINE (NOT THE POST CENTERLINE) TO THE SURFACE INDICATED.
- 4 ONE POLARIZATION SLOT FOR 2 AND 3 POSITION ASSEMBLIES ONLY.
- 5 DIMENSIONS NOTED ARE FOR SOLDER STENCIL LAYOUT FOR USE WITH .062±.008 THICK PRINTED CIRCUIT BOARDS
- 6 PARTS ARE PACKAGED IN GANG OF TUBES
- 7 OBSOLETE PART NO., REFER TO DWG 104910 FOR POS 13 THRU 25.
- 8 HOUSING: HIGH TEMPERATURE LCP, COLOR-BLACK. POSTS: BRASS.
- 9 .000015[0.000381]GOLD IN THE CONTACT AREA, .000100-.000200[0.00254-0.00508] MATTE TIN ON THE SOLDER TAIL, ALL OVER .000050[0.00127] NICKEL
- 10 0.25 [0.010] RECESS PERMISSIBLE IN THIS AREA FOR MOLD SHUT OFF

9	1.295	1.220	1.100	11	12	6-104363-1
9	1.195	1.120	1.000	10	11	6-104363-0
9	1.095	1.020	.900	9	10	5-104363-9
9	.995	.920	.800	8	9	5-104363-8
9	.895	.820	.700	7	8	5-104363-7
9	.795	.720	.600	6	7	5-104363-6
9	.695	.620	.500	5	6	5-104363-5
9	.595	.520	.400	4	5	5-104363-4
9	.495	.420	.300	3	4	5-104363-3
9	.395	.320	.200	2	3	5-104363-2
9	.295	.220	.100	-1	2	5-104363-1
	2.595	2.520	2.400	24	25	2-104363-4
	2.495	2.420	2.300	23	24	2-104363-3
	2.395	2.320	2.200	22	23	2-104363-2
	2.295	2.220	2.100	21	22	2-104363-1
	2.195	2.120	2.000	20	21	2-104363-0
	2.095	2.020	1.900	19	20	1-104363-9
	1.995	1.920	1.800	18	19	1-104363-8
	1.895	1.820	1.700	17	18	1-104363-7
	1.795	1.720	1.600	16	17	1-104363-6
	1.695	1.620	1.500	15	16	1-104363-5
	1.595	1.520	1.400	14	15	1-104363-4
	1.495	1.420	1.300	13	14	1-104363-3
	1.395	1.320	1.200	12	13	1-104363-2
1	1.295	1.220	1.100	11	12	1-104363-1
1	1.195	1.120	1.000	10	11	1-104363-0
1	1.095	1.020	.900	9	10	104363-9
1	.995	.920	.800	8	9	104363-8
1	.895	.820	.700	7	8	104363-7
1	.795	.720	.600	6	7	104363-6
1	.695	.620	.500	5	6	104363-5
1	.595	.520	.400	4	5	104363-4
1	.495	.420	.300	3	4	104363-3
1	.395	.320	.200	2	3	104363-2
1	.295	.220	.100	-1	2	104363-1
PLATING	D	C	B	A	NO OF POSN	ASSEMBLY PART NUMBER

THIS DRAWING IS A CONTROLLED DOCUMENT. DWG: G DOUITY 22FEB88
CHK: T C CLARK 22FEB88

TE Connectivity

NAME: HEADER ASSY, AMPMODU MTE, VERTICAL, SINGLE ROW, .100 C/L, .025 SQ POSTS, POLARIZED WITH LATCHING

SIZE: A1 CAGE CODE: 104363 DRAWING NO: 104363

SCALE: 4:1 SHEET: 1 OF 1 REV: U

Mouser Electronics

Authorized Distributor

Click to View Pricing, Inventory, Delivery & Lifecycle Information:

[TE Connectivity:](#)

[6-104363-1](#)