

THIS DRAWING IS UNPUBLISHED. RELEASED FOR PUBLICATION 20
 © COPYRIGHT 20 BY Tyco Electronics Japan G.K. ALL RIGHTS RESERVED.

| LOC | DIST | REVISIONS | | | | | |
|-----|------|-----------|-----|---------------------------|-----------|-----|------|
| J | - | P | LTR | DESCRIPTION | DATE | DWN | APVD |
| | | | E | REVISED | 14JUN2011 | M.M | N.Y |
| | | | E1 | REVISED PER ECR-17-007048 | 16MAY2017 | N.W | C.W |

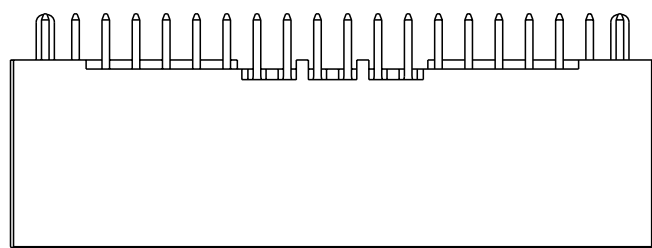

40POS(X-KEY):
 1-1871056-0(NATURAL)
 3-1871056-0(YELLOW)
 5-1871056-0(RED)

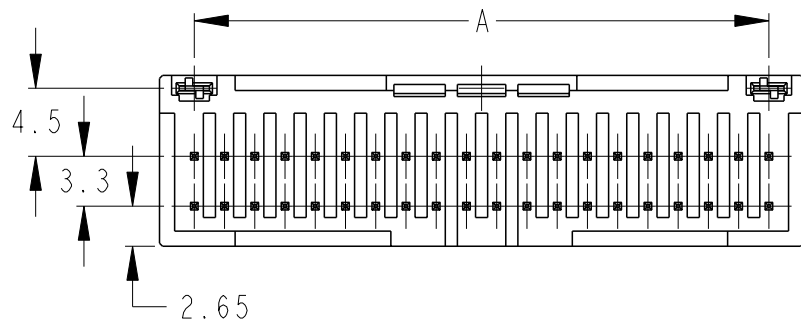
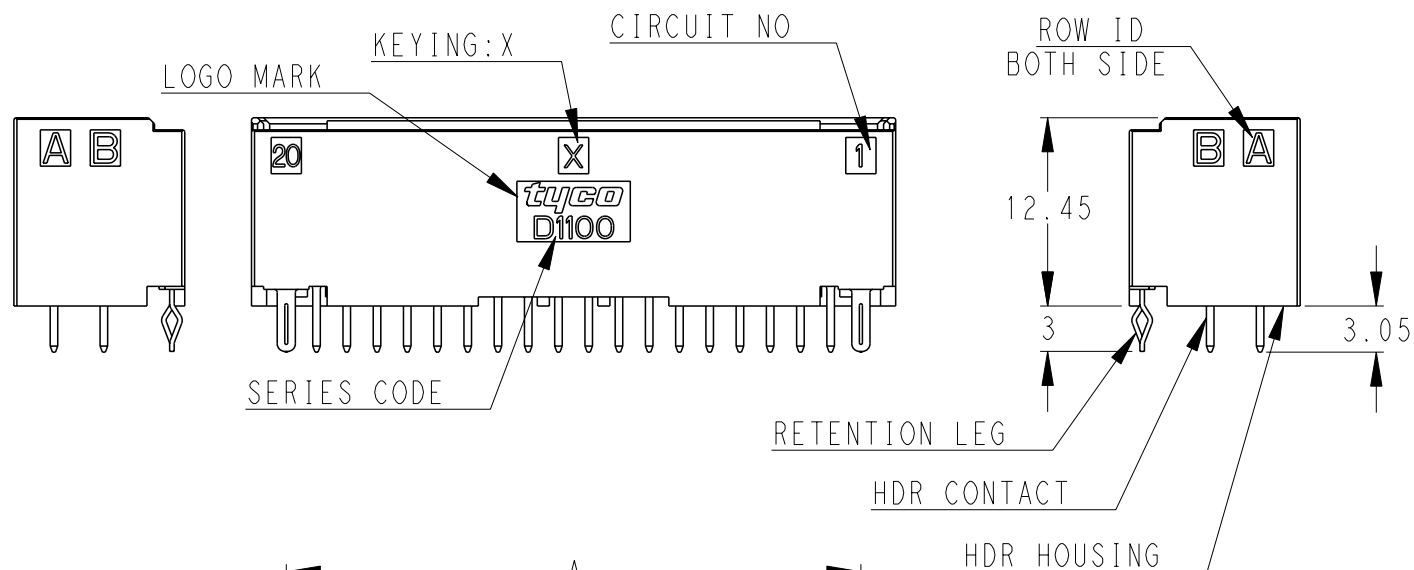
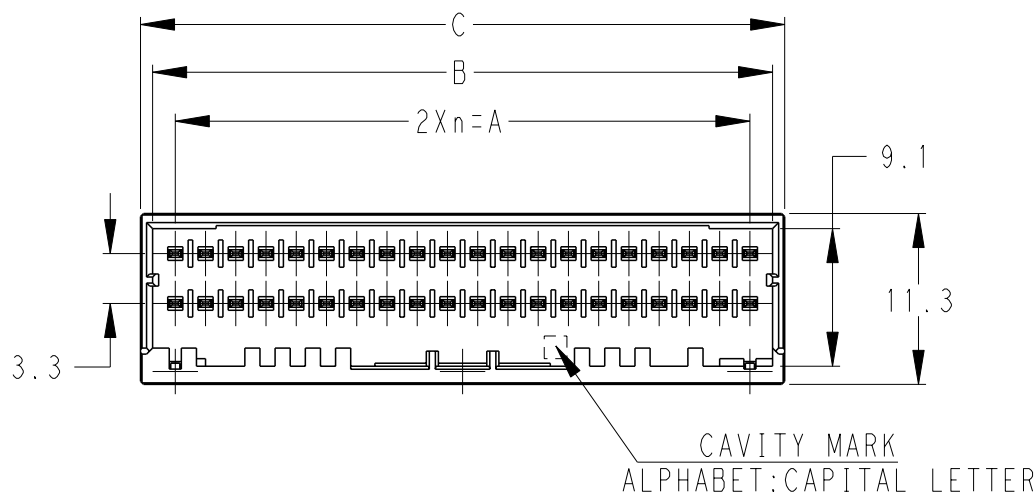
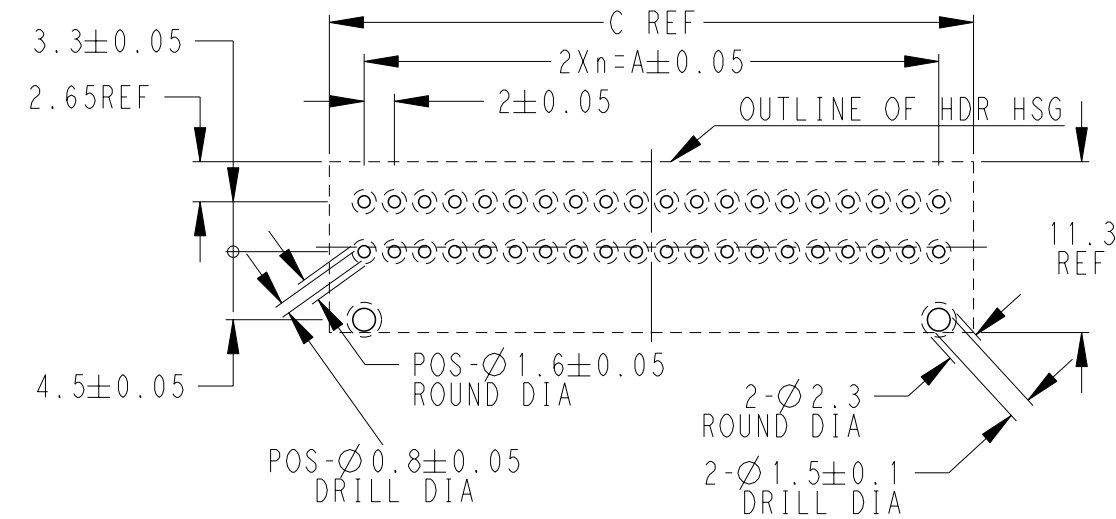

RECOMMEND PC BOARD HOLE PATTERN
 : CONNECTOR MOUNT SIDE(NOT ACCUMULATE TOLERANCE)
 PC BOARD THICKNESS : 1.0~1.6±0.1

- 1-1871056-□ : NATURAL (X-KEY) PRE-TIN
- 3-1871056-□ : YELLOW (X-KEY) PRE-TIN
- 5-1871056-□ : RED (X-KEY) PRE-TIN
- 6-1871056-□ : BLACK (X-KEY) TIN PLATED

| | | | | | | | |
|---------|---|----|------|------|-------|---------|-------------|
| 40 | X | 19 | 38.0 | 41.0 | 42.6 | BLACK | 6-1871056-0 |
| 40 | X | 19 | 38.0 | 41.0 | 42.6 | RED | 5-1871056-0 |
| 40 | X | 19 | 38.0 | 41.0 | 42.6 | YELLOW | 3-1871056-0 |
| 40 | X | 19 | 38.0 | 41.0 | 42.6 | NATURAL | 1-1871056-0 |
| 34 | X | 16 | 32.0 | 35.0 | 36.6 | BLACK | 6-1871056-7 |
| 32 | X | 15 | 30.0 | 33.0 | 34.6 | BLACK | 6-1871056-6 |
| 32 | X | 15 | 30.0 | 33.0 | 34.6 | NATURAL | 1-1871056-6 |
| 30 | X | 14 | 28.0 | 31.0 | 32.6 | BLACK | 6-1871056-5 |
| 30 | X | 14 | 28.0 | 31.0 | 32.6 | YELLOW | 3-1871056-5 |
| 30 | X | 14 | 28.0 | 31.0 | 32.6 | NATURAL | 1-1871056-5 |
| 28 | X | 13 | 26.0 | 29.0 | 30.6 | BLACK | 6-1871056-4 |
| 28 | X | 13 | 26.0 | 29.0 | 30.6 | RED | 5-1871056-4 |
| 26 | X | 12 | 24.0 | 27.0 | 28.6 | BLACK | 6-1871056-3 |
| 26 | X | 12 | 24.0 | 27.0 | 28.6 | NATURAL | 1-1871056-3 |
| 24 | X | 11 | 22.0 | 25.0 | 26.6 | BLACK | 6-1871056-2 |
| 24 | X | 11 | 22.0 | 25.0 | 26.6 | YELLOW | 3-1871056-2 |
| 22 | X | 10 | 20.0 | 23.0 | 24.6 | BLACK | 6-1871056-1 |
| 22 | X | 10 | 20.0 | 23.0 | 24.6 | YELLOW | 3-1871056-1 |
| POS KEY | n | A | B | C | COLOR | PART NO | |

1 MATERIAL:
 HOUSING : GLASS FILED THERMO PLASTIC
 POLYESTER(94V-0), COLOR:EXCLUDING BLACK
 CONTACT : PRE-TIN COPPER ALLOY,OR TIN PLATED ON COPPER ALLOY
 RETENTION LEG : PRE-TIN COPPER ALLOY

| | | | | |
|-----------------------------------------------------|--|---------------------------------|-----------------------------------------------------------------------------------|--|
| THIS DRAWING IS A CONTROLLED DOCUMENT. | | DWN T. KUDO 21APR2005 | TE Connectivity | |
| DIMENSIONS: mm | | CHK D. MITSUGI 23AUG2005 | | |
| TOLERANCES UNLESS OTHERWISE SPECIFIED: ±0.3, ±5° | | APVD D. MITSUGI 23AUG2005 | NAME DYNAMIC 1100D 2.0mmPITCH HDR ASSY (V-TYPE) TIN PLATE-COLOR 22-40POS | |
| | | PRODUCT SPEC 108-78298 | SIZE A3 | |
| MATERIAL 1 | | FINISH - | CAGE CODE 00779 | |
| | | APPLICATION SPEC 114-5377 | DRAWING NO C-1871056 | |
| | | WEIGHT - | RESTRICTED TO - | |
| | | CUSTOMER DRAWING | SCALE 2:1 | |
| | | | SHEET 1 OF 3 | |
| | | | REV E1 | |

THIS DRAWING IS UNPUBLISHED.

RELEASED FOR PUBLICATION

20

© COPYRIGHT 20

BY Tyco Electronics Japan G.K.

ALL RIGHTS RESERVED.

| LOC | DIST | REVISIONS | | | | | |
|-----|------|-----------|-----|------------------|------|-----|------|
| | | P | LTR | DESCRIPTION | DATE | DWN | APVD |
| J | - | | | SEE SHEET 1 OF 3 | | | |

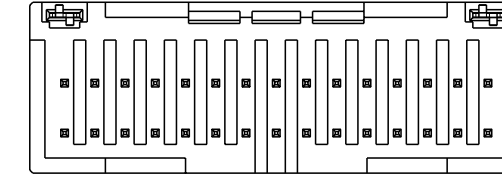
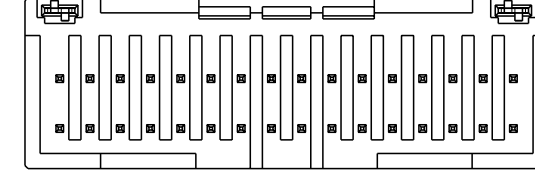
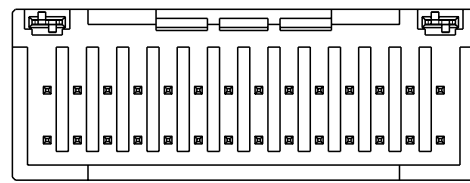
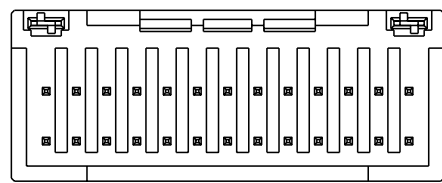
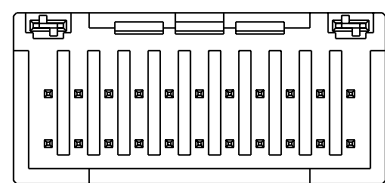
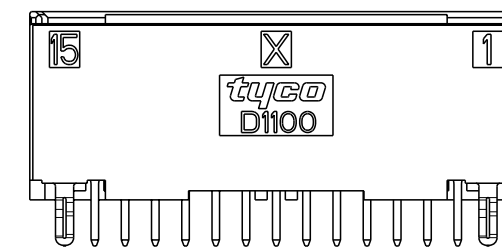
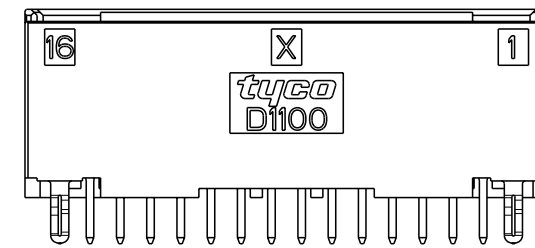
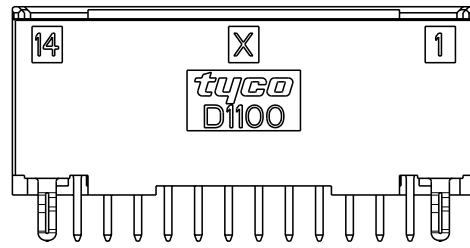
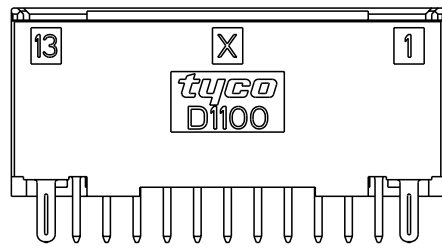
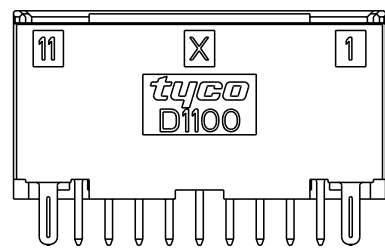
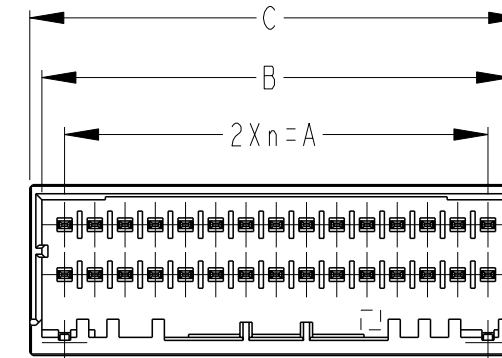
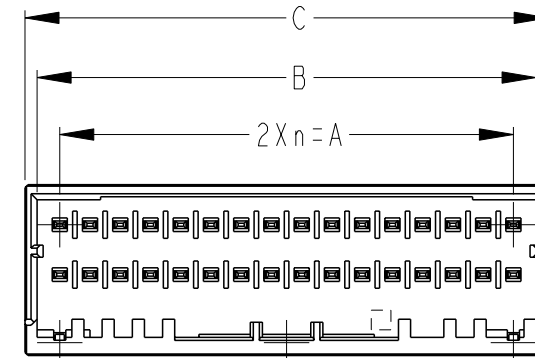
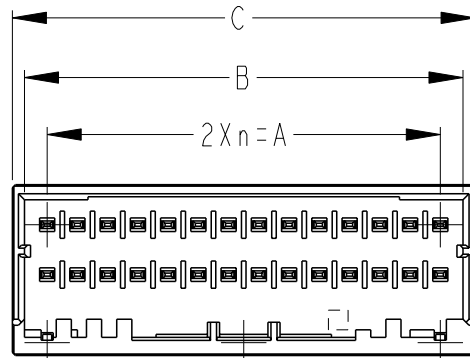
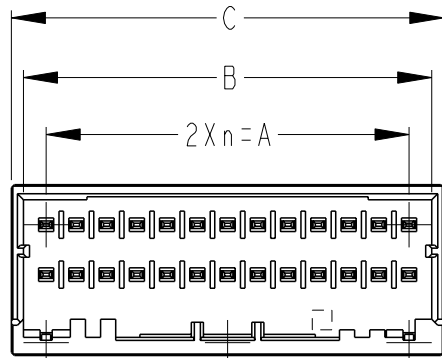
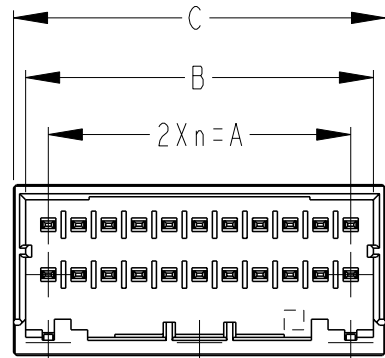

22POS(X-KEY):
3-1871056-1(YELLOW)

26POS(X-KEY):
1-1871056-3(NATURAL)

28POS(X-KEY):
5-1871056-4(RED)

32POS(X-KEY):
1-1871056-6(NATURAL)

30POS(X-KEY):
1-1871056-5(NATURAL)
3-1871056-5(YELLOW)

| | | | | |
|----------------------------------------|--|---------------------------------|-----------------------------------------------------------------------------------|--------------------|
| THIS DRAWING IS A CONTROLLED DOCUMENT. | | DWN T. KUDO 21APR2005 | TE Connectivity | |
| DIMENSIONS: mm | | CHK D. MITSUGI 23AUG2005 | | |
| TOLERANCES UNLESS OTHERWISE SPECIFIED: | | APVD D. MITSUGI 23AUG2005 | NAME DYNAMIC 1100D 2.0mmPITCH HDR ASSY (V-TYPE) TIN PLATE-COLOR 22-40POS | |
| 0 PLC ± | | PRODUCT SPEC 108-78298 | RESTRICTED TO | |
| 1 PLC ± | | APPLICATION SPEC 114-5377 | SIZE A3 | CAGE CODE 00779 |
| 2 PLC ± | | WEIGHT - | DRAWING NO C-1871056 | |
| 3 PLC ± | | CUSTOMER DRAWING | SCALE 2:1 | |
| 4 PLC ± | | | SHEET 2 OF 3 | |
| ANGLES ± | | | REV E1 | |
| FINISH - | | | | |

SEE SHEET 1 OF 3

THIS DRAWING IS UNPUBLISHED.

RELEASED FOR PUBLICATION

20

© COPYRIGHT 20

BY Tyco Electronics Japan G.K.

ALL RIGHTS RESERVED.

LOC

DIST

REVISIONS

J

-

P

LTR

DESCRIPTION

DATE

DWN

APVD

SEE SHEET 1 OF 3

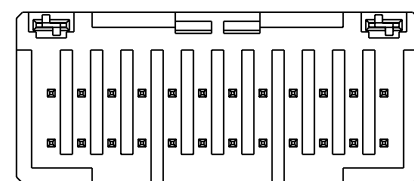
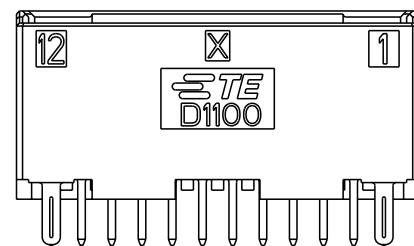
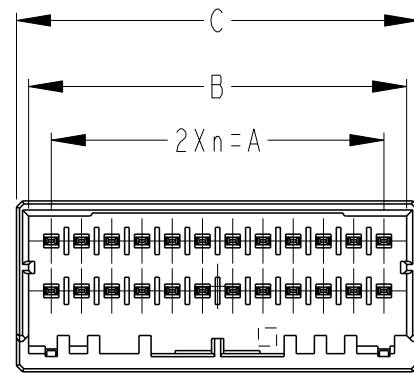

24POS(X-KEY):
3-1871056-2(YELLOW)

THIS DRAWING IS A CONTROLLED DOCUMENT.

DIMENSIONS:
mm



TOLERANCES UNLESS OTHERWISE SPECIFIED:

- 0 PLC ±
- 1 PLC ±
- 2 PLC ±
- 3 PLC ±
- 4 PLC ±
- ANGLES ±

MATERIAL

-

FINISH

-

DWN T. KUDO 21APR2005

CHK D. MITSUGI 23AUG2005

APVD D. MITSUGI 23AUG2005

PRODUCT SPEC

108-78298

APPLICATION SPEC

114-5377

WEIGHT

-

CUSTOMER DRAWING



TE Connectivity

NAME

DYNAMIC 1100D 2.0mmPITCH
HDR ASSY (V-TYPE)
TIN PLATE-COLOR 22-40POS

SIZE

CAGE CODE

DRAWING NO

RESTRICTED TO

A3

00779

C-1871056

-

SCALE 2:1

SHEET 3 OF 3

REV E1

Mouser Electronics

Authorized Distributor

Click to View Pricing, Inventory, Delivery & Lifecycle Information:

[TE Connectivity:](#)

[5-1871056-6](#)