

Type SM Series

Key Features

Low Profile Design

Available on Tape

Very Wide Value Range

Ideal for Power Circuitry

Available in 4 ratings up to 7 Watts

Flameproof Coating
UL94V0



TE Connectivity (TE) introduces a surface mount power resistor suited to meet today's circuit design needs. Each size offers low profile case design with flexible tinned copper terminations for reliable solder joints. All styles utilize a fully welded construction technique, unlike other designs that rely solely on tinned termination connections. These features allow the SM Series to withstand the higher temperatures associated with reflow, vapour phase, or infrared (IR) manufacturing processes without degradation. Now also available at 7W power rating.

Characteristics – Electrical

| | SMW – Wire | SMF – Metal Film |
|-----------------------------|-----------------|------------------|
| Values SM_2: | R10 – 200R | 201R – 2M |
| Values SM_3: | R10 – 300R | 301R – 2M |
| Values SM_5: | R10 – 500R | 501R – 2M |
| Values SM_7: | R10 – 1K0 | 1K1 – 2M |
| Value Grid: | E24 | |
| Resistance Tolerance: | 1% or 5% | |
| Power Rating @ 20°C SM_2: | 2.0 Watts | |
| Power Rating @ 20°C SM_3: | 3.0 Watts | |
| Power Rating @ 20°C SM_5: | 5.0 Watts | |
| Power Rating @ 20°C SM_7: | 7.0 Watts | |
| Derating: | See Curve Below | |
| Max Operating Voltage SM_2: | 300 Volts | |
| Max Operating Voltage SM_3: | 500 Volts | |
| Max Operating Voltage SM_5: | 500 Volts | |
| Max Operating Voltage SM_7: | 750 Volts | |
| Operating Temperature Range | -55 ~ 200°C | |

Environmental Characteristics

| Test | Condition | SM (Wire) | SM (Metal Film) | | | | | | | | | | | | | | | |
|--|--|-------------------------------------|-----------------|--------|---|-------|----|---|------------|-----|---|-------|----|---|-----------|-----|-----------------------------------|--|
| Temperature Coefficient of Resistance: | -55°C – +200°C | ± 200ppm /°C | ± 100ppm /°C | | | | | | | | | | | | | | | |
| Temperature Cycle | <table border="1"> <thead> <tr> <th>Step</th> <th>Temp.°C</th> <th>Time m</th> </tr> </thead> <tbody> <tr> <td>1</td> <td>-55±3</td> <td>30</td> </tr> <tr> <td>2</td> <td>Room Temp.</td> <td>2~3</td> </tr> <tr> <td>3</td> <td>200±3</td> <td>30</td> </tr> <tr> <td>4</td> <td>Room Temp</td> <td>2~3</td> </tr> </tbody> </table> | Step | Temp.°C | Time m | 1 | -55±3 | 30 | 2 | Room Temp. | 2~3 | 3 | 200±3 | 30 | 4 | Room Temp | 2~3 | Resistance change Rate within ±1% | |
| Step | Temp.°C | Time m | | | | | | | | | | | | | | | | |
| 1 | -55±3 | 30 | | | | | | | | | | | | | | | | |
| 2 | Room Temp. | 2~3 | | | | | | | | | | | | | | | | |
| 3 | 200±3 | 30 | | | | | | | | | | | | | | | | |
| 4 | Room Temp | 2~3 | | | | | | | | | | | | | | | | |
| Short Time Overload: | 5 times of rated wattage for 5 sec. | ± 1% | ± 0.5% | | | | | | | | | | | | | | | |
| Rated Load: | Rated voltage for 30 minutes | ± 3% | ± 1% | | | | | | | | | | | | | | | |
| Insulation Resistance: | 500VDC | 10,000 MΩ | 10,000 MΩ | | | | | | | | | | | | | | | |
| Load Life: | 70°C 1.5 hrs on 0.5 hrs off for 1000 hrs | ± 2% (7W ±5%) | ± 1% (7W ±5%) | | | | | | | | | | | | | | | |
| Humidity Load Life: | 40°C ±2°C @ 90-95% RH 500 hrs 1.5 hrs on 0.5 hrs off | ± 2% (7W ±5%) | ± 1% (7W ±5%) | | | | | | | | | | | | | | | |
| Voltage Withstand: | 500VAC for 60 seconds No Physical damage | No Physical damage | | | | | | | | | | | | | | | | |
| Solderability: | 235°C ±5°C for 2 seconds | 95% coverage | | | | | | | | | | | | | | | | |
| Resistance to Soldering Heat: | 270°C ±5°C for 10 ±1seconds | Resistance value change within ± 1% | | | | | | | | | | | | | | | | |

Dimensions

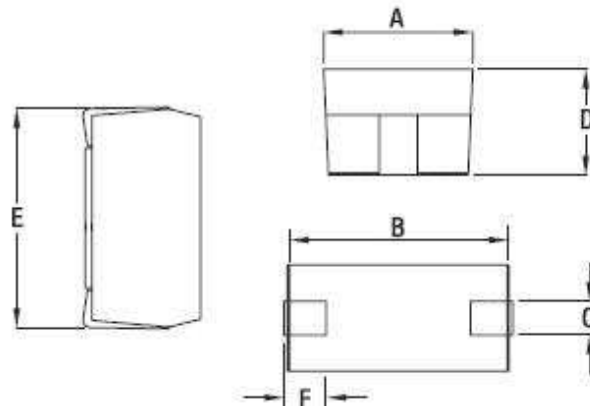

| | A±0.3 | B±0.3 | C±0.3 | D±0.3 | E Max. | F±0.3 | Reel Qty |
|-------|-------|-------|-------|-------|--------|-------|----------|
| SM 2W | 4.0 | 6.7 | 1.4 | 3.55 | 7.9 | 1.5 | 2000 |
| SM 3W | 5.5 | 10.5 | 1.7 | 5.0 | 12.0 | 2.3 | 1000 |
| SM 5W | 7.3 | 13.5 | 1.7 | 6.8 | 17.0 | 2.5 | 1000 |
| SM 7W | 9.5 | 23.0 | 5.0 | 9.6 | 24.5 | 4.5 | 300 |

Derating Curve



Surface Temperature rise

SMW/SMF

Surface Temperature Rise



SM Series Pulse Characteristics

SMW 2W



Condition test: Resistance change $\leq \pm 5\%$ with pulse 1000 cycles as like the figure.(Reference Only)
 1. Added power and added voltage are within the lower territory of this graph.
 2. Added in normal temperature and humidity.



SMF 2W



Condition test: Resistance change $\leq \pm 5\%$ with pulse 1000 cycles as like the figure.(Reference Only)
 1. Added power and added voltage are within the lower territory of this graph.
 2. Added in normal temperature and humidity.



SMW 3W



Condition test: Resistance change $\leq \pm 5\%$ with pulse 1000 cycles as like the figure.(Reference Only)
 1. Added power and added voltage are within the lower teritory of this graph.
 2. Added in normal temperature and humidity.



SMF 3W

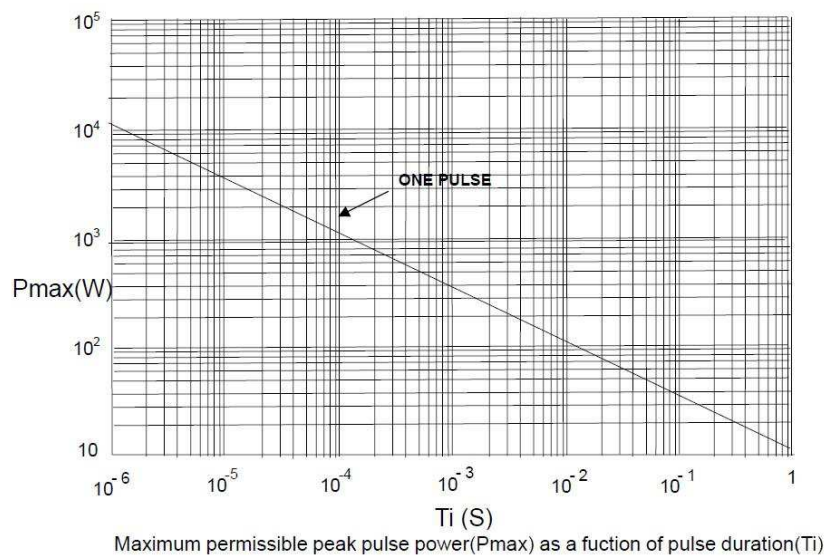

Condition test: Resistance change $\leq \pm 5\%$ with pulse 1000 cycles as like the figure.(Reference Only)
 1. Added power and added voltage are within the lower teritory of this graph.
 2. Added in normal temperature and humidity.



SMW 5W

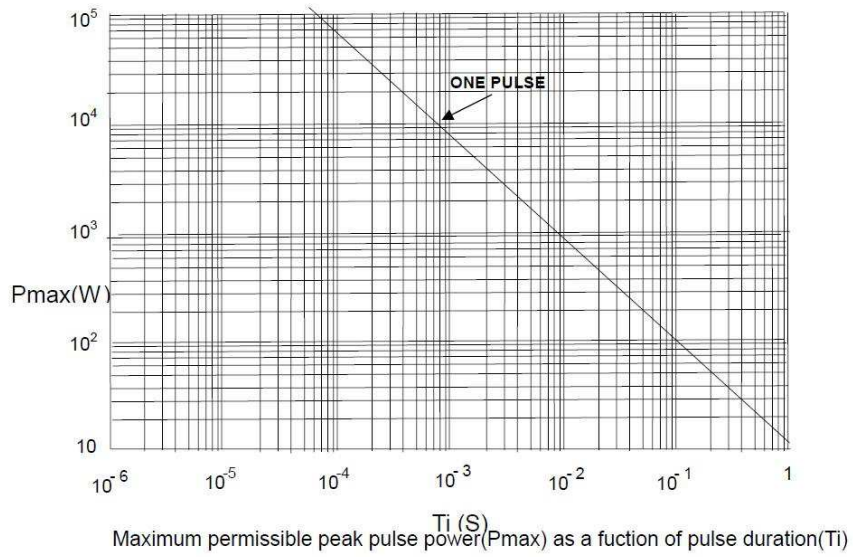

Condition test: Resistance change $\leq \pm 5\%$ with pulse 1000 cycles as like the figure.(Reference Only)
 1. Added power and added voltage are within the lower territory of this graph.
 2. Added in normal temperature and humidity.



SMF 5W

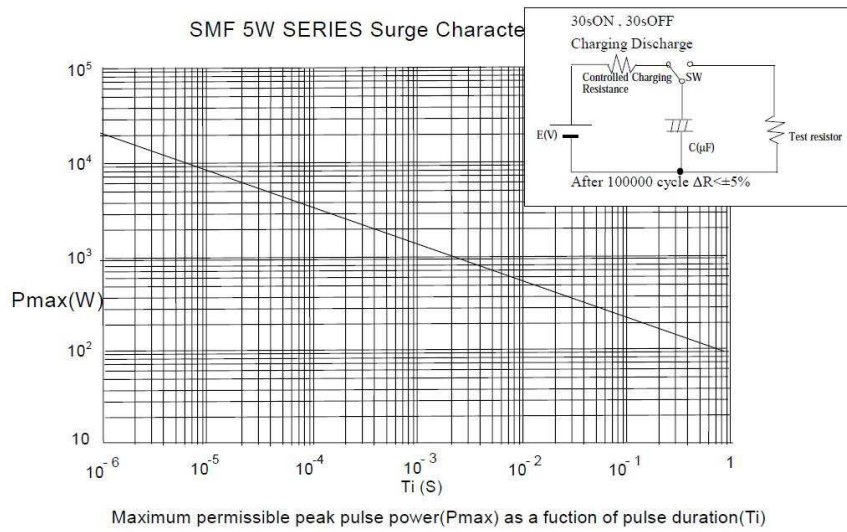

SMW 7W



Condition test: Resistance change $\leq \pm 5\%$ with pulse 1000 cycles as like the figure.(Reference Only)
 1. Added power and added voltage are within the lower territory of this graph.
 2. Added in normal temperature and humidity.



SMF 7W



Condition test: Resistance change $\leq \pm 5\%$ with pulse 1000 cycles as like the figure.(Reference Only)
 1. Added power and added voltage are within the lower territory of this graph.
 2. Added in normal temperature and humidity.



Marking



Packaging

SM 2W – 5W

Reel



Tape

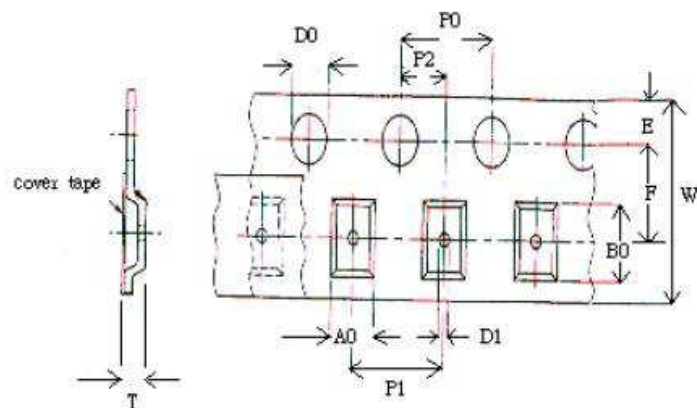

| Rated Power | B0 ± 0.2 | A0 ± 0.2 | P1 ± 0.1 | P2 ± 0.1 | P0 ± 0.1 | D0 ± 0.1 | E ± 0.1 | F ± 0.1 | W ± 0.3 | D1 ± 0.1 | T ± 0.1 | pcs/reel |
|-------------|----------|----------|----------|----------|----------|----------|---------|---------|---------|----------|---------|----------|
| 2W | 8 | 4.3 | 8 | 2 | 4 | 1.5 | 1.75 | 7.5 | 16 | 1.5 | 4.15 | 2000 |
| 3W | 11.8 | 5.8 | 12 | 2 | 4 | 1.5 | 1.75 | 11.5 | 24 | 1.5 | 5.8 | 1000 |
| 5W | 17.5 | 7.8 | 16 | 2 | 4 | 1.5 | 1.75 | 14.2 | 32 | 1.5 | 7.5 | 500 |

SM 7W

Reel

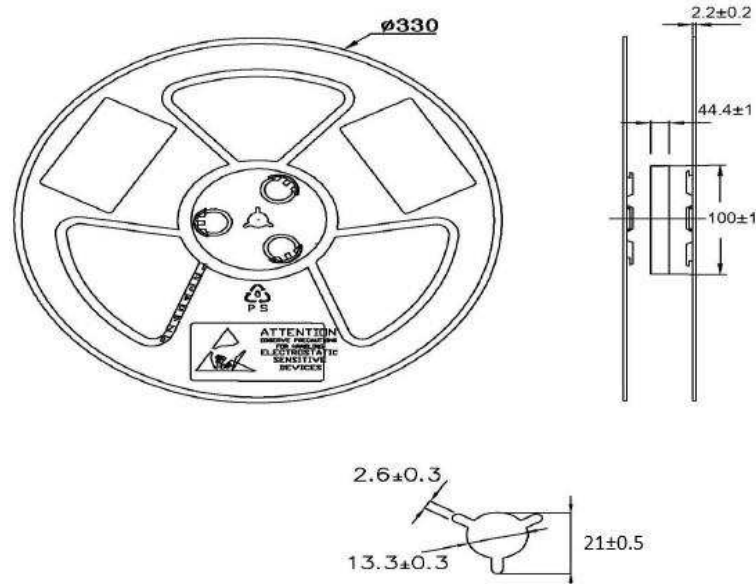

Tape

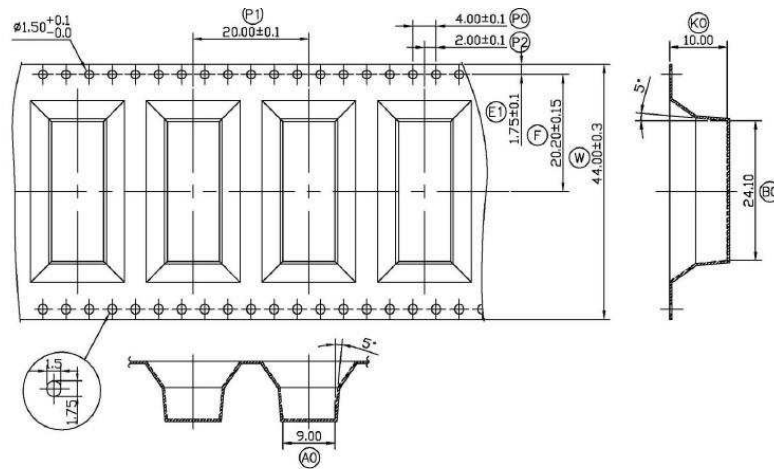

How To Order

| SMF | 3 | 10K | F | T |
|-------------------------------------|--|--|--------------------|-----------------|
| Common Part | Case size | Resistance value | Tolerance | Pack Style |
| SMW - Wirewound SMF - Metal Film | 2 - 2 Watts 3 - 3 Watts 5 - 5 Watts 7 - 7 Watts | 0.1 ohm (100 milli ohms) - R10 1 ohm -1R0 100 ohm -100R 1K ohm (1000 ohms) -1K0 100K ohm (100,000 ohms) - 100K | J - ±5% F - ±1% | T - Tape & Reel |

Mouser Electronics

Authorized Distributor

Click to View Pricing, Inventory, Delivery & Lifecycle Information:

[TE Connectivity:](#)

[SMF5430KJT](#)