

REVISIONS					
P	LTR	DESCRIPTION	DATE	DWN	APVD
	11	INITIAL RELEASE	11FEB2020	GK	AK

NOTES: -

1. CHARACTERS: -

0-9, A-Z, +, -, /, ~, ≡

0, 1, 6 & 9 FOLLOWED BY A FULL STOP.

HEIGHT 2.6 - 2.9 mm

TOLERANCE (AXIAL) ±0.75

(ROTATIONAL) ±5°

CHEVRON CUT MARKERS: -

CHARACTERS TO BE CENTRALLY DISPOSED ON MARKER FACE AND IN THE ATTITUDE SHOWN RELATIVE TO CHEVRON.

2. MARKER LENGTHS ( DIMENSION 'A'): -

WITH SINGLE MARK 4.00 - 4.75

WITH DOUBLE MARK 6.75 - 7.25

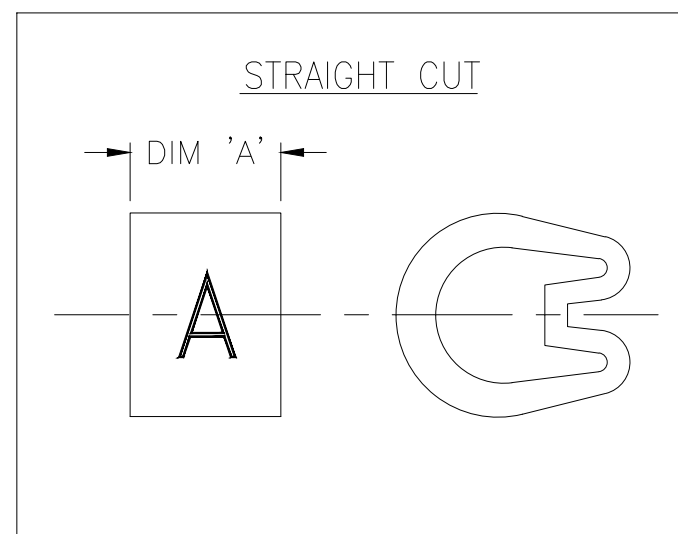
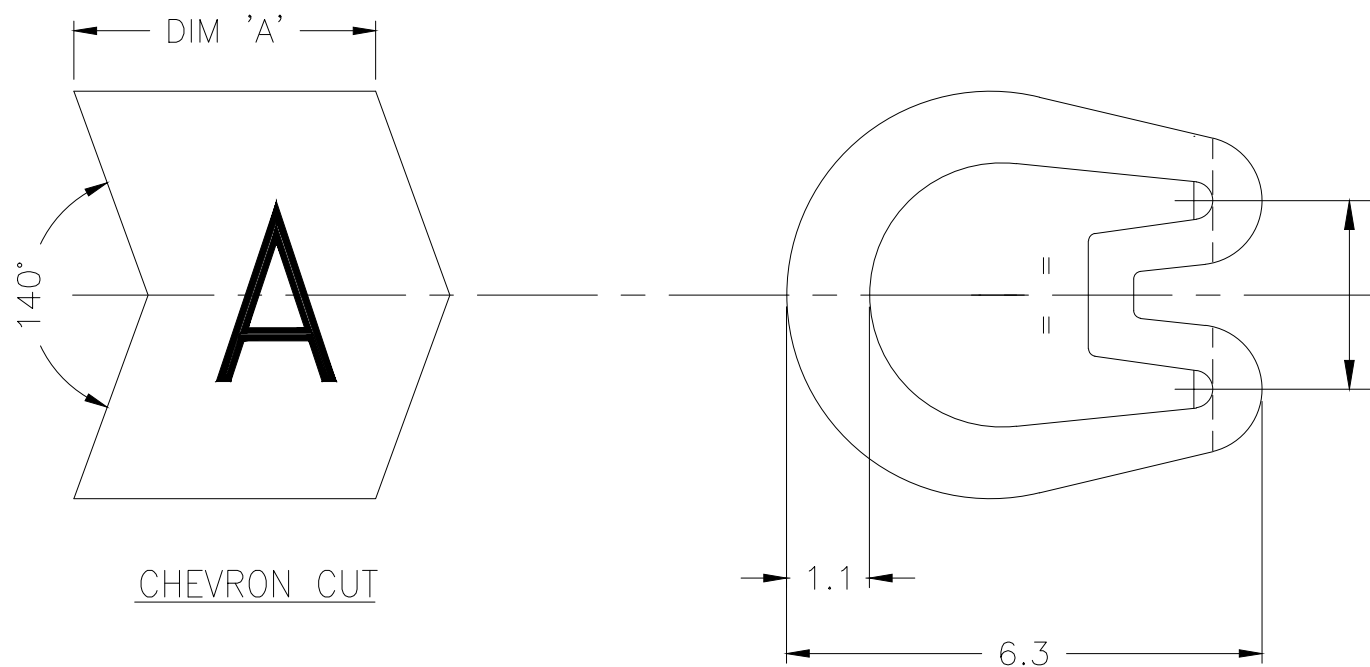

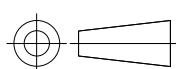
THIS DRAWING IS A CONTROLLED DOCUMENT.		DWN GOPALAKRISHNA H V 11FEB2020	 TE Connectivity		
DIMENSIONS: mm		CHK ALAN KEAN 11FEB2020			
		APVD ALAN KEAN 11FEB2020	NAME MARKER Z TYPE SIZE 15 STRAIGHT / CHEVRON CUT		
TOLERANCES UNLESS OTHERWISE SPECIFIED:		PRODUCT SPEC -	RESTRICTED TO -		
0 PLC ± - 1 PLC ± 0.2 2 PLC ± - 3 PLC ± - 4 PLC ± - ANGLES ± -		APPLICATION SPEC -	SIZE A3	CAGE CODE 00779	DRAWING NO C-1601A0006
MATERIAL PVC 4.9 - 4.4g/250mm		FINISH -	WEIGHT -	SCALE 10:1	SHEET 1 OF 1
CUSTOMER DRAWING			REV 11		

# Mouser Electronics

Authorized Distributor

Click to View Pricing, Inventory, Delivery & Lifecycle Information:

[TE Connectivity:](#)

[EC1142-000](#)