

THIS DRAWING IS UNPUBLISHED. RELEASED FOR PUBLICATION  
 © COPYRIGHT - By - TE CONNECTIVITY ALL RIGHTS RESERVED.

LOC	DIST	REVISIONS					
HB	-	P	LTR	DESCRIPTION	DATE	DWN	APVD
		E		CHANGE LOGO&ADD LINE IDENTIFICATION ECO-12-003498&ADD COC SYMBOL P-11-003756	05-Nov-12	YS.H	BH.Y
		E1		ADD NEW PN ECO-19-015756	21-Oct-19	WQ.Y	K.T

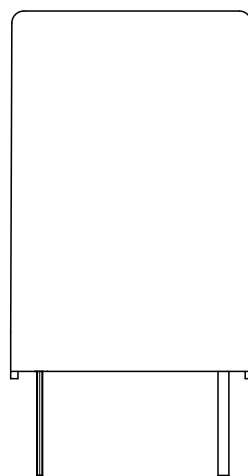

DRILLING DIAGRAM (BOTTOM VIEW)

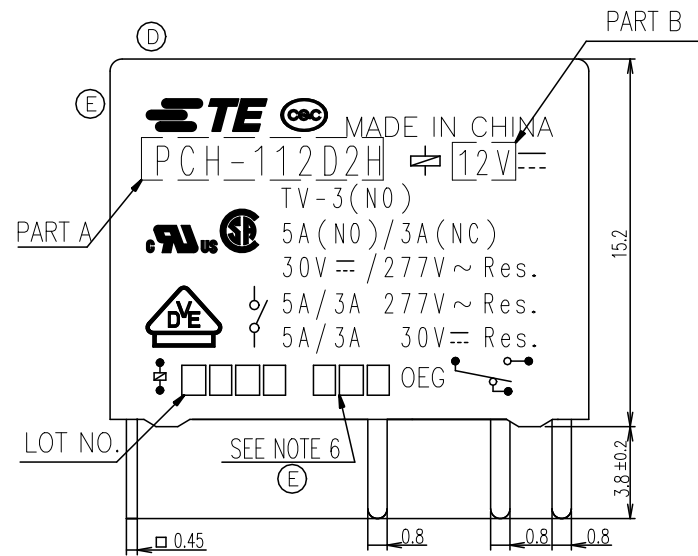
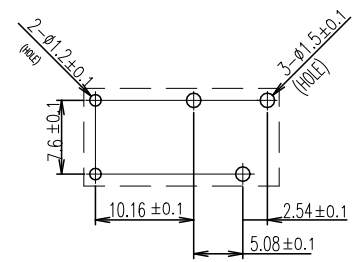

CONNECTION DIAGRAM (BOTTOM VIEW)

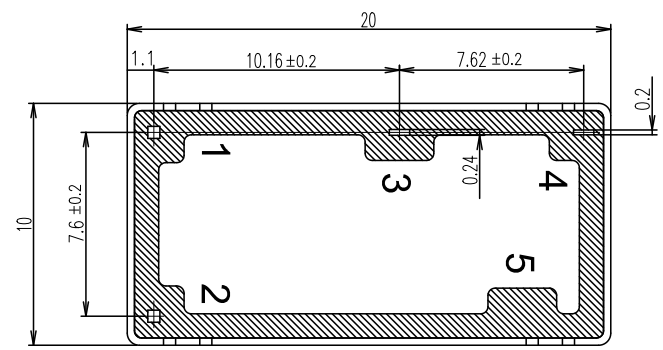
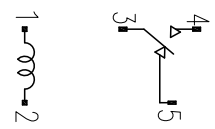

Diagram dimension	Tolerance
0.99mm max.	±0.1mm
1 - 2.99mm	±0.2mm
3mm min.	±0.3mm

THIS DRAWING IS A CONTROLLED DOCUMENT.		DWN	H,SASAKI	TE Connectivity			
		CHK	N,FUMAYAMA				
		APVD	A,NAGAI	NAME			
		PRODUCT SPEC	-				
		APPLICATION SPEC	-				
		WEIGHT	-				
		CUSTOMER DRAWING		SIZE	CAGE CODE	DRAWING NO	RESTRICTED TO
				A3	00779	1461410	-
				SCALE	5:1	SHEET	1 OF 2
						REV	E1

4

3

2

1

THIS DRAWING IS UNPUBLISHED. RELEASED FOR PUBLICATION - . - .  
 © COPYRIGHT - By - TE CONNECTIVITY ALL RIGHTS RESERVED.

LOC	DIST	REVISIONS					
HB	-	P	LTR	DESCRIPTION	DATE	DWN	APVD
		-		SEE SHEET 1	-	-	-

1461410-5	PCH-112D2H	12V	PCH-112D2H	107-79019(TRAY)	n	Ⓔ
1461410-4	PCH-148D2H	48V	PCH-148D2H	107-79019(TRAY)	n	Ⓒ
9-1440003-5	PCH-124D2H	24V	PCH-124D2H	107-79019(TRAY)	m	Ⓒ
1461410-3	PCH-118D2H	18V	PCH-118D2H	107-79019(TRAY)	l	Ⓒ
9-1440003-3	PCH-112D2H	12V	PCH-112D2H	107-79019(TRAY)	k	Ⓒ
9-1440003-2	PCH-109D2H	9V	PCH-109D2H	107-79019(TRAY)	j	Ⓒ
9-1440003-1	PCH-106D2H	6V	PCH-106D2H	107-79019(TRAY)	i	Ⓒ
9-1440003-0	PCH-105D2H	5V	PCH-105D2H	107-79019(TRAY)	h	Ⓒ
1461410-2	PCH-148D2	48V	PCH-148D2	107-79019(TRAY)	g	Ⓒ
1440004-1	PCH-124D2	24V	PCH-124D2	107-79019(TRAY)	f	Ⓒ
1461410-1	PCH-118D2	18V	PCH-118D2	107-79019(TRAY)	e	Ⓒ
1440004	PCH-112D2	12V	PCH-112D2	107-79019(TRAY)	d	Ⓒ
9-1440003-9	PCH-109D2	9V	PCH-109D2	107-79019(TRAY)	c	Ⓒ
9-1440003-8	PCH-106D2	6V	PCH-106D2	107-79019(TRAY)	b	Ⓒ
9-1440003-7	PCH-105D2	5V	PCH-105D2	107-79019(TRAY)	a	Ⓒ
TE PART NO	TE TYPE NAME	PART B	PART A	PACKAGE SPEC	TYPE	

RELAY TYPE

NOTES:

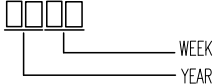
- 1. LAST SUFFIX NON : WASHABLE TYPE
- Ⓔ 2. LOT NO SYSTEM AS FOLLOWING:  

- Ⓒ 3. TERMINAL DIMENSION IS BEFORE SOLDER DIP;
- Ⓒ 4. FOR THE TIN-PLATING OF THE PINS:  
 +0.1mm FOR WIDTH, THICKNESS AND DIAMETER.  
 +0.5mm FOR LENGTH.
- Ⓒ 5. MARKING FROM INK TO LASER.



Ⓒ 6. ADD LOT NO. SYSTEM AS FOLLOWING;



- I, DIGITS FOR DAY OF THE WEEK  
 1...MONDAY IN THIS WEEK;  
 2...TUESDAY IN THIS WEEK;  
 7...SUNDAY IN THIS WEEK
- II, DIGITS FOR SHIFT OF THE DAY  
 1...DAY SHIFT IN THIS DAY;  
 2...NIGHT SHIFT IN THIS DAY;
- III, ONE CHARACTER DISTINGUISH THE LINE IDENTITY, SUCH AS: A,B,...Z

		UV RESIN	UV SEAL	17
		EPOXY RESIN	SEAL	16
		UEW	COIL WIRE	15
	SOLDER DIP	HCP WIRE	COIL TERMINAL	14
		Ag ALLOY	STATIONARY CONTACT	13
		Ag ALLOY	MOVBLE CONTACT	12
		Cu ALLOY	HINGE SPRING	11
	SOLDER DIP	Cu ALLOY	NC TERMINAL	10
	SOLDER DIP	Cu ALLOY	NC TERMINAL	9
	SOLDER DIP	Cu ALLOY	MOVABLE SPRING	8
UL94 V-0		PBT	CARD	7
UL94 V-0		PBT	CASE	6
UL94 HB		PA66	BOBBIN	5
UL94 V-0		PBT	BASE	4
	Ni PLATED	STEEL	CORE	3
	Ni PLATED	STEEL	ARMATURE	2
	Ni PLATED	STEEL	YOKE	1
INCOMBUSTIBILITY	TREATMENT	MATERIAL	DESCRIPTION	ITEM

THIS DRAWING IS A CONTROLLED DOCUMENT.		DWN	H,SASAKI	TE Connectivity	
		CHK	N,FUMAYAMA		
		APVD	A,NAGAI	NAME	
		PRODUCT SPEC	-	PCH SPEC,000 CUSTOMER DRAWING	
		APPLICATION SPEC	-		
		WEIGHT	-	SIZE	RESTRICTED TO
		CUSTOMER DRAWING	A3	00779	1461410
		SCALE	5:1	SHEET	2 OF 2
		REV	E1		

DIMENSIONS:	TOLERANCES UNLESS OTHERWISE SPECIFIED:
mm	
	0 PLC ±
	1 PLC ±
	2 PLC ±
	3 PLC ±
	4 PLC ±
	ANGLES ±
MATERIAL	FINISH
-	-

# Mouser Electronics

Authorized Distributor

Click to View Pricing, Inventory, Delivery & Lifecycle Information:

[TE Connectivity:](#)

[PCH-148D2,000](#)