

THIS DRAWING IS UNPUBLISHED. RELEASED FOR PUBLICATION 20  
 © COPYRIGHT 20 BY - ALL RIGHTS RESERVED.

REVISIONS					
P	LTR	DESCRIPTION	DATE	DWN	APVD
A3		REVISED PER ECR-16-011494	30MAY2017	NK	CX
A4		ECO-19-006934	10MAY2019	AP	WLS
B		REVISED PER ECN-20-100924	15DEC2020	WLS	VS

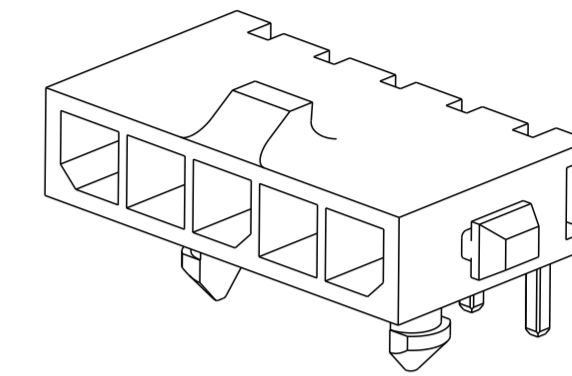

- 1 MATERIAL: HOUSING - UL 94V-0 RATED HIGH TEMP NYLON, COLOR BLACK. CONTACTS - BRASS
- 2 RECOMMENDED PC BOARD THICKNESS OF 1.57.
- 3 PLATING: CONTACTS - 0.76µm MINIMUM GOLD ON MATING AREA. 2.54µm MINIMUM MATTE TIN ON SOLDER TAILS. ALL OVER 1.27µm MINIMUM NICKEL.
- 4 COUNTERPART RECOMENDED IS PN 1445022 (DASH ACCORDING TO NUMBER OF POSITION).
- 5 FOR REELING DIRECTION AND PACKAGING TYPE, SEE SPECIFICATION 114-13000.

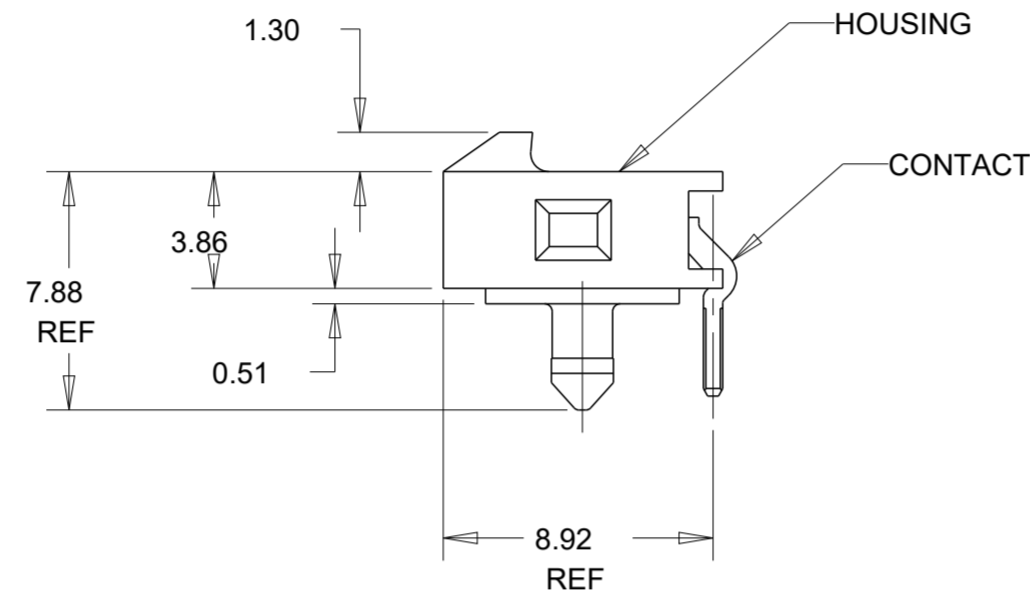
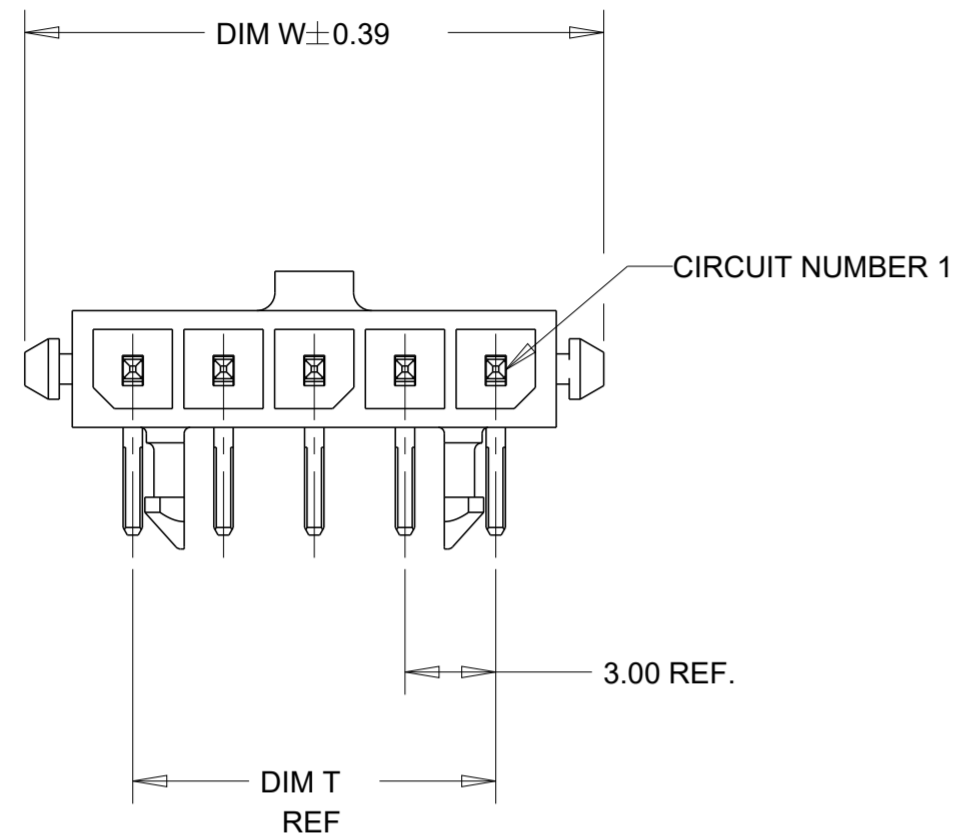
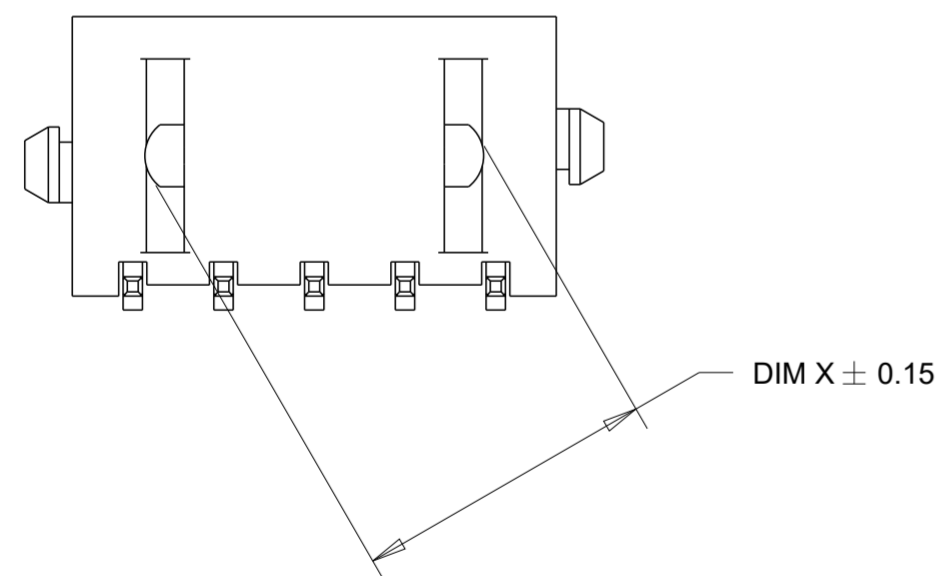

32.20	33.00	28.70	33.00	40.14	12	3-1445098-2
29.20	30.00	25.70	30.00	37.14	11	3-1445098-1
26.20	27.00	22.70	27.00	34.14	10	3-1445098-0
23.20	24.00	19.70	24.00	31.14	9	2-1445098-9
20.20	21.00	16.70	21.00	28.14	8	2-1445098-8
17.20	18.00	13.70	18.00	25.14	7	2-1445098-7
14.20	15.00	10.70	15.00	22.14	6	2-1445098-6
11.20	12.00	7.70	12.00	19.14	5	2-1445098-5
8.00	9.00	4.70	9.00	16.14	4	2-1445098-4
3.30	-	-	6.00	13.14	3	2-1445098-3
3.30	-	-	3.00	10.14	2	2-1445098-2
DIM X	DIM Z	DIM V	DIM T	DIM W	NO. OF POSN	PART NUMBER

THIS DRAWING IS A CONTROLLED DOCUMENT.		DWN J.ROOT 09OCT2000	TE Connectivity	
DIMENSIONS:		CHK K. WHITAKER 17-APR-2001		
mm	TOLERANCES UNLESS OTHERWISE SPECIFIED:	APVD C. JONES 17-APR-2001	NAME RIGHT ANGLE THRU HOLE HEADER ASSY, 0.76 MIC GOLD CONTACTS, W/PLASTIC HOLDDOWNS, SGL ROW, MICRO MATE-N-LOK	
0 PLC ±	1 PLC ±	PRODUCT SPEC 108-1836	SIZE A2	CAGE CODE 00779
2 PLC ±0.13	3 PLC ±	APPLICATION SPEC 114-13000	DRAWING NO 1445098	RESTRICTED TO -
4 PLC ±	ANGLES ±1°	WEIGHT -	SCALE 4:1	SHEET 1 OF 2
MATERIAL	FINISH	CUSTOMER DRAWING	REV B	

REVISIONS				
P	LTR	DESCRIPTION	DATE	APVD
-	-	SEE SHEET 1	-	-

2 POS.

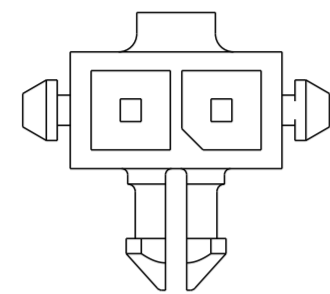

8 POS.

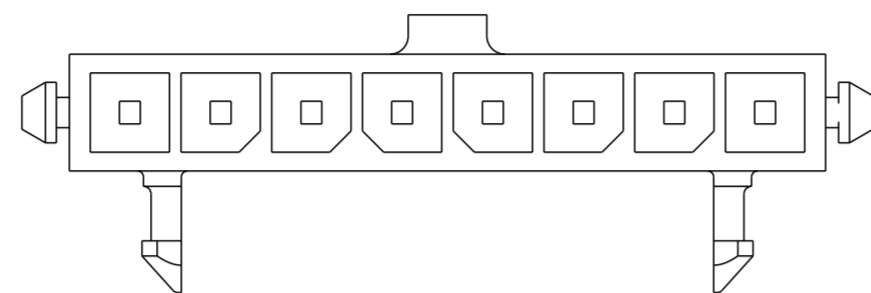

3 POS.

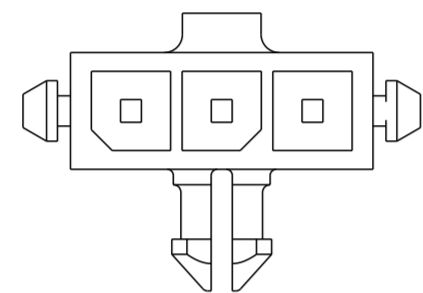

9 POS.

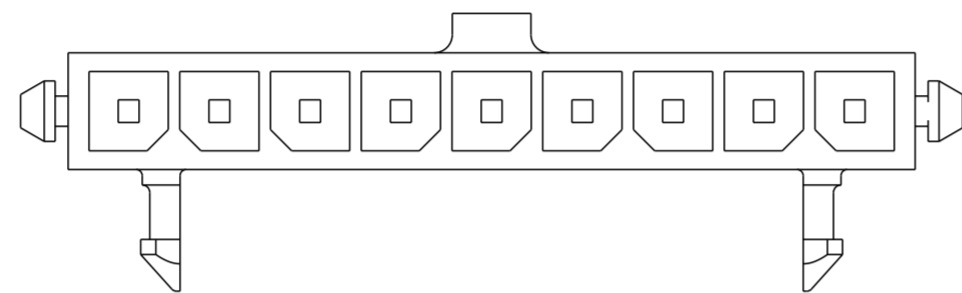

4 POS.

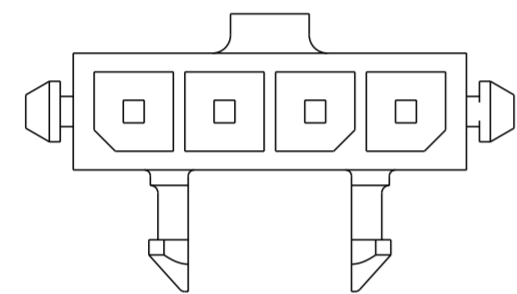

10 POS.

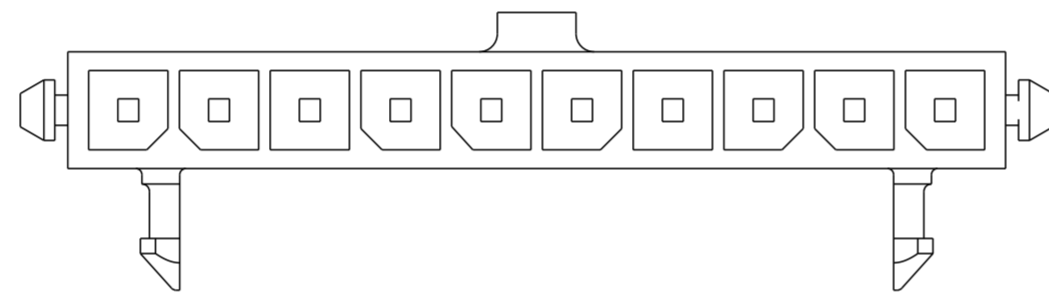

5 POS.

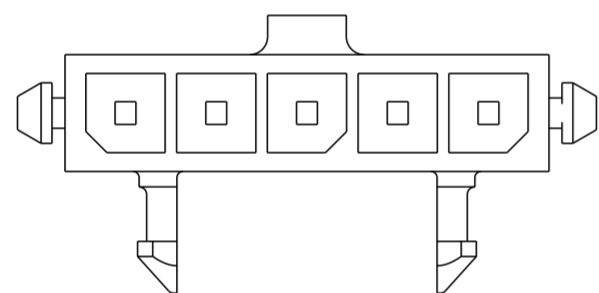

11 POS.

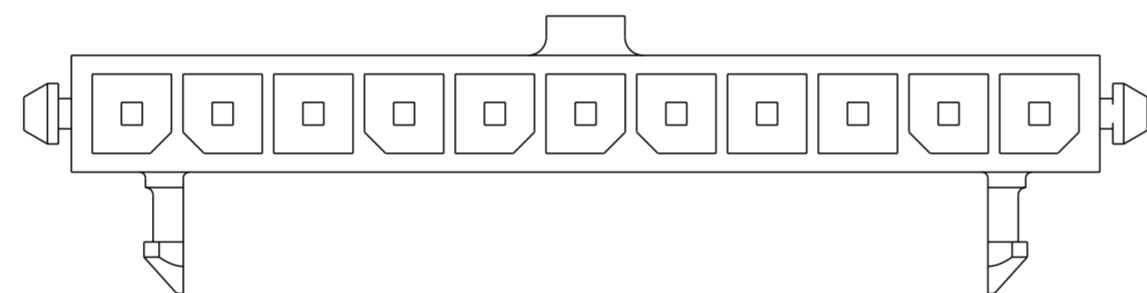

6 POS.

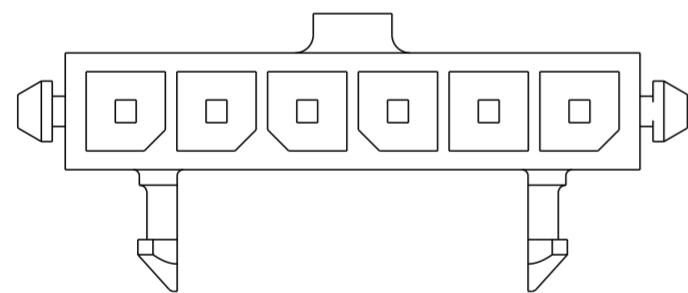

12 POS.

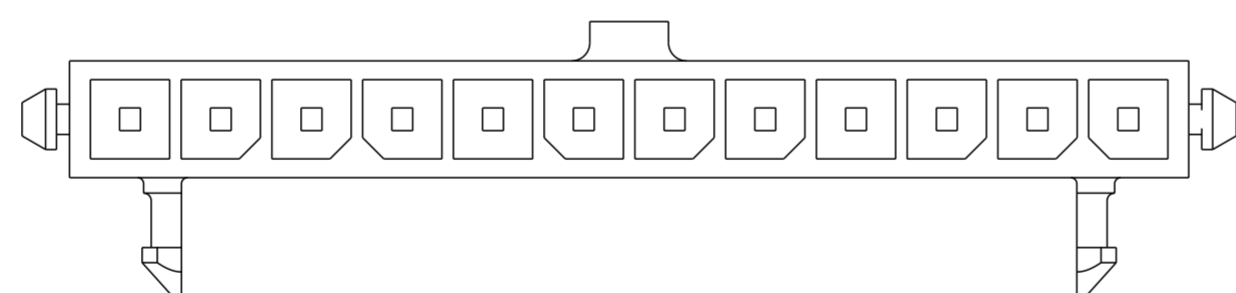

7 POS.

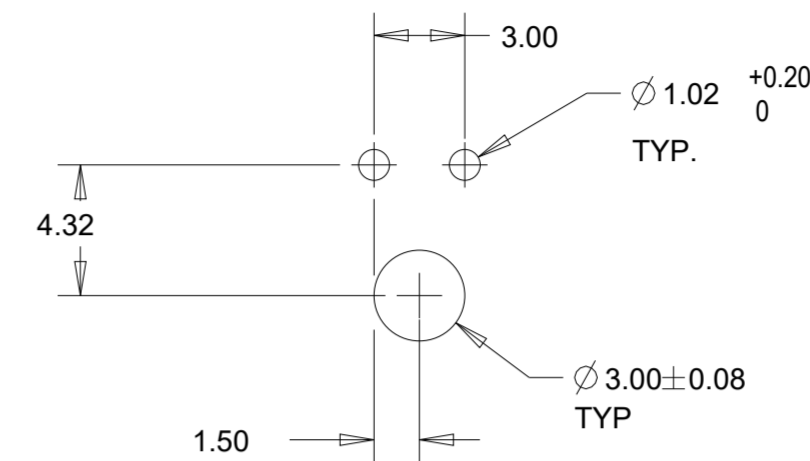
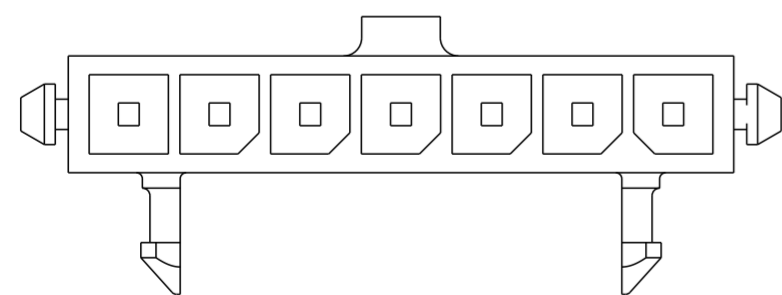

PCB LAYOUT FOR 2 POSITION COMPONENT SIDE

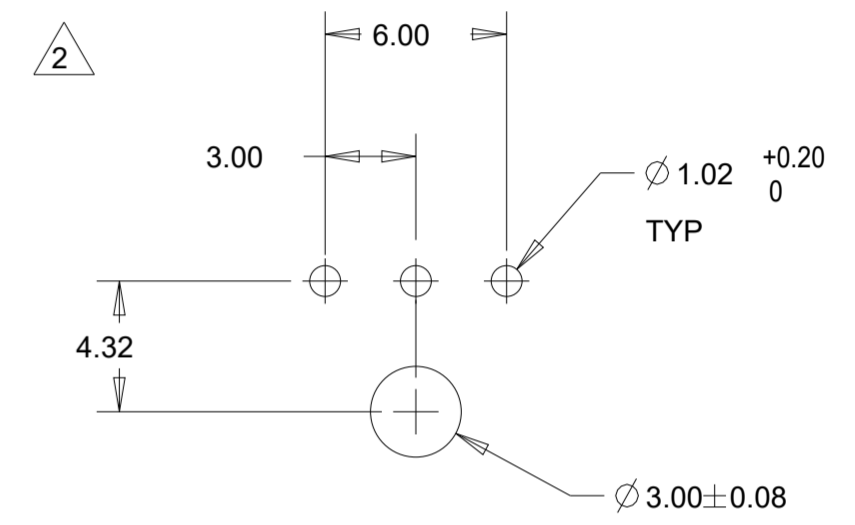

PCB LAYOUT FOR 3 POSITION COMPONENT SIDE

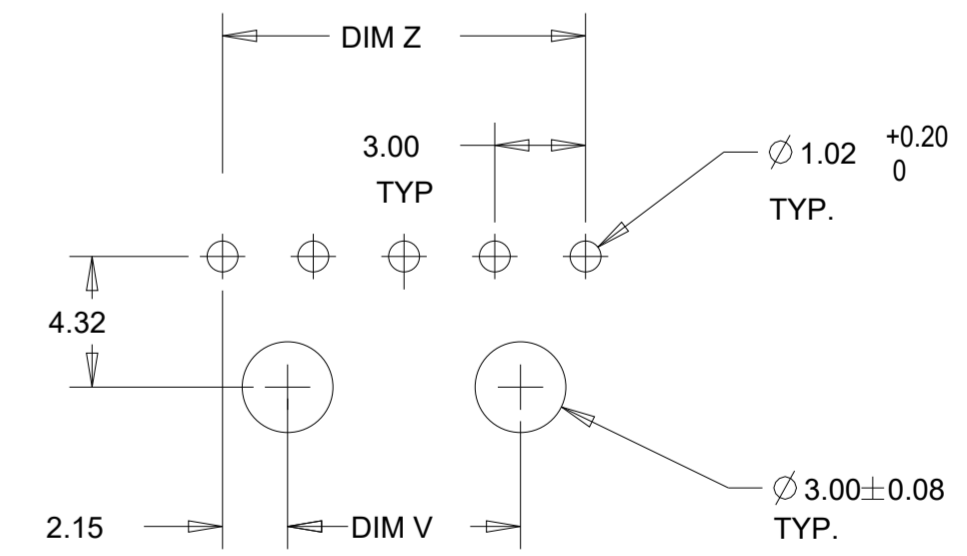

PCB LAYOUT FOR 4-12 POSITION COMPONENT SIDE

KEYING POSITION BI SIZE

THIS DRAWING IS A CONTROLLED DOCUMENT.		DWN J.ROOT 09OCT2000	TE Connectivity	
DIMENSIONS:		CHK K. WHITAKER 17-APR-2001		
mm	TOLERANCES UNLESS OTHERWISE SPECIFIED:	APVD C. JONES 17-APR-2001	NAME RIGHT ANGLE THRU HOLE HEADER ASSY, 0.76 MIC GOLD CONTACTS, W/PLASTIC HOLDDOWNS, SGL ROW, MICRO MATE-N-LOK	
	0 PLC ± 1 PLC ± 2 PLC ±0.13 3 PLC ± 4 PLC ± ANGLES ±1° FINISH	PRODUCT SPEC -	SIZE A2	CAGE CODE 00779
MATERIAL	-	APPLICATION SPEC -	DRAWING NO 1445098	RESTRICTED TO -
		WEIGHT -	SCALE 5:1	SHEET 2 OF 2
		CUSTOMER DRAWING	REV B	

# Mouser Electronics

Authorized Distributor

Click to View Pricing, Inventory, Delivery & Lifecycle Information:

[TE Connectivity:](#)

[1445098-5](#)