

11mm Rotary Encoder

Type DP11 Series

Type DP11 Series



11mm Rotary incremental encoder for use in electronic equipment. Can be supplied with or without switch with customisation to standard options

Key Features

- 11mm Rotary Encoder
- Incremental Type
- Push on Switch Option
- Various Shaft Lengths
- Pulse Options
- Detent Options

Characteristics - Electrical

Pulses:	15, 20
Contact Rating:	10mA 5VDC
Dielectric Strength:	300VAC / 1mA, 1 minute
Insulation Resistance (min):	100M ohms at 250VAC
Operating Speed (RPM):	60 RPM
Switch Power Rating (where fitted):	16VDC, 3A (10mA Min)
Switch Contact Resistance:	100m ohm Max
Electrical Travel:	Continuous
Rotational Noise:	t2 = 2.0 ms max (see below)
Chattering:	t1 & t3 = 3.0 ms max (see below)



Code Off area V = 3.5V or more. Code on area V=1.5V or less

Characteristics - Mechanical

Total Mechanical Travel:	Continuous
Detents:	0, 20, 30
Switch Operating Force:	612+/- 306gf (for 1.5mm Switch Travel 400+/- 200gf)
Switch Travel:	0.5mm (1.5mm available on request)
Shaft Type:	F – Flatted, K – Knurled, S – Slotted, P - Plain
Shaft Length (from Mounting Surface):	15, 20, 25, 30 (FMF)

Characteristics - Environmental

Operating Temperature	-10 ~ +45 degrees C
Rotational Life	15,000 Cycles

Output Signal Format

Shaft Rotational Direction	Signal	Format
Clockwise	A (Terminal A-C)	OFF ON
	B (Terminal B-C)	OFF ON
Anticlockwise	A (Terminal A-C)	OFF ON
	B (Terminal B-C)	OFF ON

Dimensions DP11H



DP11SH

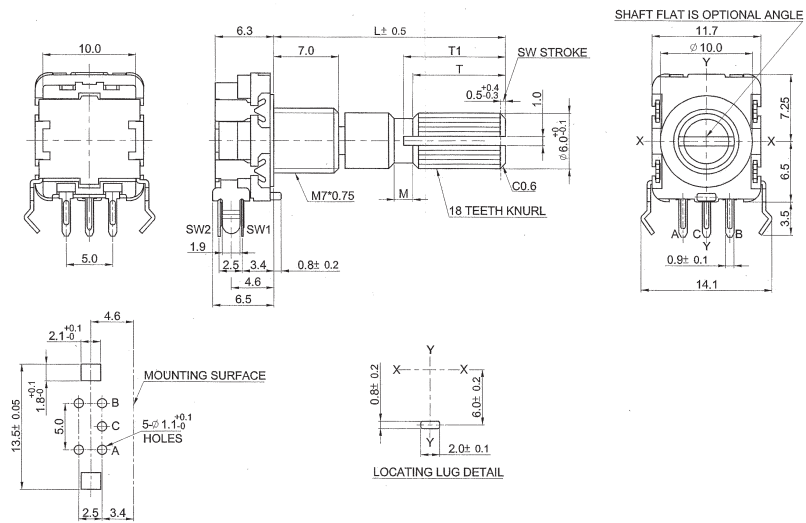

Dimensions DP11V



DP11SV



Shaft Dimensions

Bush		5mm				7mm			
Shaft	Code								
K	L	15	20	25	30	15	20	25	30
	T1	7	7	11	14	6	7	11	14
	T	6	6	10	12	5	6	10	12
	M	2	2	2	4	1	1	2	4
F	L	15	20	25	30	15	20	25	30
	F	7	12	12	12	5	7	12	12

How to Order

DP11	H	N	15	A	15	F
Common Part	Orientation	Detent	Pulses	Bush Details	Shaft Length	Shaft Style
DP11 – No Switch DP11S – With Switch	H - Horizontal V - Vertical	N - None 20 – 20 clicks 30 – 30 clicks	15 – 15 Pulses 20 – 20 Pulses	A – M7 x 5mm B – M7 x 7mm (standard)	15 – 15mm FMF 20 – 20mm FMF 25 – 25mm FMF 30 – 30mm FMF	K - Knurled F - Flatted S - Slotted P - Plain

Mouser Electronics

Authorized Distributor

Click to View Pricing, Inventory, Delivery & Lifecycle Information:

[TE Connectivity:](#)

[DP11HN15B15P](#)