

ELCON Drawer Series Connectors True Hot-Plug, Blind-Mating Mixed Signal and Power Connectors

Product Facts

- Wide variety of contact sizes and styles from 1 Amp signals up to power contacts rated at up to 200 Amps each
- Sequenced contacts for “mate-first-break-last” operation
- Floating panel-mount connectors float up to +/- 2 mm
- High durability specific products ranging from 100 to 1000 mate/un-mate cycles
- Customizable products allow the freedom to add or remove power or signal contacts to meet specific application requirement
- Most products recognized to US and Canadian requirements under the Component Recognition program of Underwriters Laboratories File No. E28476



Typical Applications

- Low noise power supplies
- Switch-mode power supplies (SMPS)
- Power factor-correcting (PFC) power supplies
- Systems requiring mounting to backplane or chassis
- Redundant (N + 1) power systems
- “Live” hot-plug power supplies
- All ELCON drawer connectors in this section are RoHS compliant

Technical Documents

Product Specification
108-2285

Application Specification
114-13206



Tyco Electronics offers a wide selection of blind-mateable “drawer” connectors to suit modular equipment designs. The term “drawer connector” was created to describe a cabinet drawer where the connector is installed at the back of the drawer and is mated by closing the drawer. Since the “drawer” is often times made with a somewhat loose fit — to enable easy opening and closing, the drawer connector must provide sufficient self-alignment and ideally a floating connection to the cabinet or drawer to keep the connection from binding.

The power drawer connectors in this catalog are divided into two separate categories: high power drawers and low power drawers. Specifically, the

product line names in these two categories are:

High Power Drawer Connectors

- ELCON Drawer Series Connectors

Low Power Drawer Connectors

- AMP Drawer Series Connectors
 - Mini Power Drawer
 - Blind-mate Drawer Connectors
 - Hybrid Mini Drawer Connectors

Some of the benefits of the power drawer connectors from Tyco Electronics are the robustness of the housing designs and the durability of the contacts. High-end applications such as networking switches and servers want the lowest possible voltage drop across the connector. For these applications the high conductivity screw-machined contacts with either gold or silver plating offer the best performance.

The contacts are the core of the ELCON drawer series connectors. For cost sensitive applications the different hybrid drawer connectors offer a wide variety of shapes and sizes aimed at keeping cost minimized and still providing a reliable separable interface.

Regardless of the application, Tyco Electronics offers a wide variety of power & signal blind-mateable drawer connectors.

Need more information?

Call Technical Support at the numbers listed below.

Technical Support is staffed with specialists well versed in all Tyco Electronics products. They can provide you with:

- Technical Support
- Catalogs
- Technical Documents
- Product Samples
- Tyco Electronics Authorized Distributor Locations

ELCON Drawer Series Connectors
True Hot-Plug, Blind-Mating Mixed Signal and Power Connectors (Continued)



3 mm Diameter Test Probe in Accordance with IEC 435 Protective Cap (insulator)

Probe-proof Double CROWN BAND Contacts

The size #0 contacts used in the Top Drawer, Double Drawer, DualPower and QuadPower connectors are also available in a probe-proof double CROWN BAND version. These contacts are specially suited for operator-serviced power supplies that require extra safety protection.

Signal/Power Sequencing

All signal and some power contacts are available in various lengths to allow multiple levels of sequencing, thus giving the engineer further design flexibility.

Mating Polarization

To provide for positive housing mating of connectors, polarization is provided in the form of molded-in guide posts or pre-installed guide pins.

Regulatory Agency Certifications

Tyco Electronics ELCON drawer series connectors have been evaluated and found to comply with the UL1977 standard and the CSA standard C22.2 No. 182.3-M1987.

Tyco Electronics can also work with the customer to obtain application-specific regulatory certifications if needed.



Wide Array of Standard Contacts

ELCON drawer connectors support various termination styles, including crimp for cable, solder tail and compliant press-fit for mounting

to PCB, and internal/ external threads for termination to lugs and/or busbars. See table below for details.

Contact Size	Termination				
	PC Tail	Press-fit	Crimp	Threaded	
				Internal	External
#20	•	•	•		
#16	•	•	•		
#12	•	•	•		
#8	•	•	•	•	•
#4			•	•	•
#0			•	•	•

Application-Specific Designs

If none of our standard drawer connectors satisfies your requirements, Tyco Electronics can develop an ELCON connector design specific to your application. We will

work closely with your engineers to fully understand the design requirements and develop an interconnect solution that meets your stated needs. After the concept and design stages,

Tyco Electronics produces prototypes that perform both electrically and mechanically the same as production parts. These machined parts are used for testing, regulatory

agency evaluations and even as pre-production components, allowing the shortest lead time from concept to manufacturing in the industry.

Concept

Tyco Electronics engineers work closely with the customer to fully understand the design requirements.



Design

A sketch drawing of the design concept is created for customer review, and the design is finalized only when it fully meets the requirements of the customer.



Prototypes

The design is frozen and work on the mold tools starts. Meanwhile, Tyco Electronics builds prototypes that are identical to the production parts.



Production

By the time the customer is ready for production, all requirements for release to production, such as qualification and regulatory agency approval, have been cleared.



How to Tailor Your ELCON Drawer Connector

If you selected a standard drawer connector for your application, before placing an order you need to specify your application-specific requirements, such as housing type, contact loading, and termination style. Layout forms for all standard drawer connectors, such as the one shown below, are available online at <http://www.tycoelectronics.com> or can be obtained from Tyco Electronics customer service for

this purpose. Complete a form for the pin and socket side of your connector as indicated in the instructions and fax it to your Tyco Electronics sales engineer. We will issue a unique part number specific to your configuration, which you can then use to place orders. Samples and customer drawings are also available upon request.

Pin Assembly

1. Choose one housing from the **Pin Housing Selection Menu** table. Place an X in the appropriate guide pin circles, if guide pins are required.
2. Write the total quantity of each pin contact you require for each pin assembly in the **Qty** column of the **Pin Contact Selection Menu** table.
3. Crimp contacts are shipped uninstalled. Threaded and PCB tail contacts are installed by Tyco Electronics; enter the letter reference of the desired contact in the appropriate contact positions on the drawing: e.g., if you need a size #20 premate PCB tail standard contact to be installed in contact position #10, write "Q" in circle #10.
4. Sign, date and send the completed form to your local Tyco Electronics Sales Engineer.

Pin Connector (Rear Face)

Pin Contact Insertion Side

Pin Connector Rear Face Cavity Identification

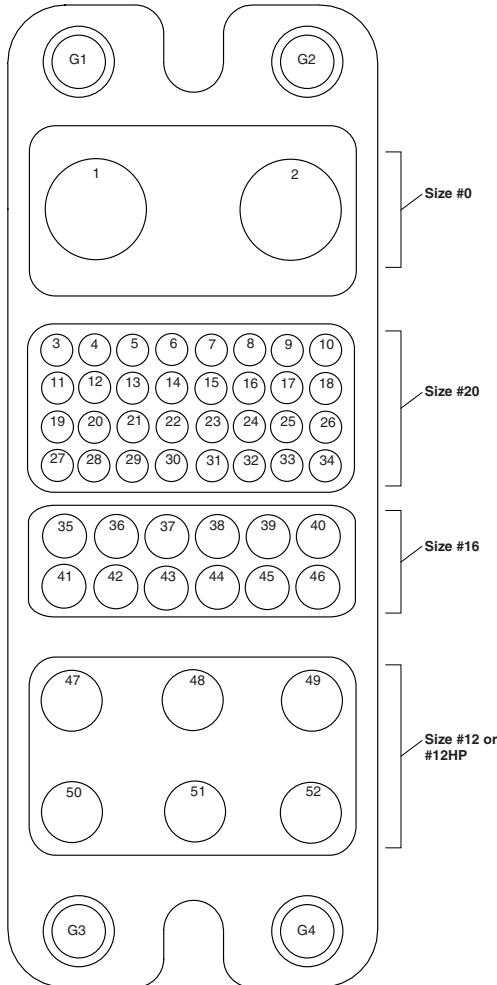

Top Assembly Part Number Assigned by Tyco Electronics

ENTER CUSTOMER INFORMATION	
Company	Location
Contact Name	Title
Telephone	Fax
Email Address	
I am: <input type="checkbox"/> End user <input type="checkbox"/> Contract manufacturer (end user: _____)	
Signature	Today's Date
	Annual Quantity Required

Submit to your local Tyco Electronics Sales Engineer.

Pin Housing Selection Menu		Check One
Part Number	Description	
1648183-1	Housing without guides	
	Housing with guides (#6-32 thread)	
	Housing with guides (M3 x 0.5 thread)	

Pin Contact Selection Menu				Qty.
Size	Ref.	Part Number	Termination Style & Pin Length	
#0	A =	1766811-1	Crimp	
	B =	1766819-1	Probe Proof, crimp	
	C =	1766230-1	1/4-20 Internal Thread	
	D =	1766274-1	M6 x 1 Internal Thread	
	E =	1766269-1	Probe Proof, 1/4-20 Internal Thread	
	F =	1766275-1	Probe Proof, M6 x 1 Internal Thread	
	G =	1766268-1	1/4-20 External Thread	
	H =	1766231-1	M6 x 1 External Thread	
	J =	1766270-1	Probe Proof, 1/4-20 External Thread	
	K =	1766276-1	Probe Proof, M6 x 1 External Thread	
	#20	L =	1650155-1	Crimp, standard
M =		1650161-1	Crimp, premate	
N =		1650162-2	Crimp, postmate	
P =		1650283-1	PCB tail, standard	
Q =		1650065-1	PCB tail, premate	
R =		1650226-1	PCB tail, postmate	
S =		1766196-1	Crimp, standard	
T =		1766198-1	Crimp, premate	
#16	U =	1766199-2	Crimp, postmate	
	V =	1766222-1	PCB tail, standard	
	W =	1766223-1	PCB tail, premate	
	X =	1766818-1	PCB tail, postmate	
	Y =	1766193-1	Crimp, standard	
	Z =	1766195-1	Crimp, premate	
	AA =	1766196-1	Crimp, postmate	
#12	AB =	1766245-1	PCB tail, standard	
	AC =	1766250-1	PCB tail, premate	
	AD =	1766249-1	PCB tail, postmate	
	AE =	1650153-2	Crimp, standard, Hot-Plug	
	AF =	1650156-2	Crimp, premate, Hot-Plug	
	AG =	1650060-2	PCB tail, standard, Hot-Plug	
	AH =	1650074-3	PCB tail, premate, Hot-Plug	
	#12 Hot-Plug			

Crimp and Threaded contacts are removable. PCB tail contacts are non-removable.

Float-Mount Shoulder Screw		Qty.
Part Number	Description	
1650399-1	Screw, No 10-32 UNC 2A	
1650401-1	Screw, M5 x 0.8	

ELCON Drawer Connector Mounting

All ELCON drawer series connectors can be fix-mounted or float-mounted using the designated shoulder screws to allow improved gatherability for blind-mating of the connector. Panel cut out dimensions are shown on the customer drawing specific to your ELCON drawer connector.

Panel Float Mounting

When float-mounting to a panel or chassis, use the stainless steel shoulder screws specified in the layout sheet or customer drawing specific to your ELCON drawer connector. Shown in the sketch below is an example of how the Top Drawer connector is float-mounted to a panel.

Float-Mount of Top Drawer (Example)



Screw Description	Part Number	Used On
#10-32 UNF 2A Thread	1650399-1	Top and Double Drawer, Dual and QuadPower, In-Line QuadPower, W5 Drawer
M5 x 0.8 Metric Thread	1650401-1	
#8-32 UNF 2A Thread	1650402-1	
#6-32 UNF 2A Thread	1650106-1	All Other Drawers
M4 x 0.7 Metric Thread	1650589-1	

Panel Fix Mounting

As a rule of thumb, ELCON drawer connectors can be fix-mounted to a panel, in two ways: (1) by attaching a screw through the top and bottom mounting flange of the housing; or (2) by attaching a screw into a threaded guide pin (for those connectors that have one). An example of each case is shown in the sketches below.

Screw Through Mounting Flange of Housing

Fix to the panel by attaching a commercially available screw and a washer through the top and bottom mounting flange of the housing.



Screw Into Thread of Guide Pin (When Applicable)

You can optionally fix-mount housings that have a guide pin by attaching a commercially available screw and washer into the thread on the back of the guide pin, as shown in the figures below.

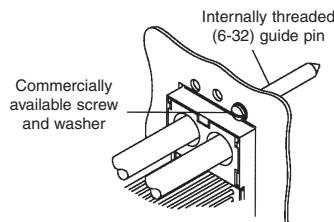

Note: All part numbers are RoHS compliant.

ELCON Drawer Connector Mounting (Continued)

Strain Relief and Wire Dress

If required, wires can be bundled together and supported with cable ties. Wires must not be stretched or confined in any way that would restrict the floating action of the connectors. Therefore, the wires must remain perpendicular to the connector and avoid an excessively sharp bend radius. The minimum recommended distance for the cable tie, and the minimum bend radius of a wire bundle are shown in the figure to the right.



PCB Fix Mounting

When mounting to a PC board, the connector standoffs must be seated on the board. Hold-downs are recommended to provide stability during the soldering procedure. PCB-mount hole patterns are shown on the customer drawing specific to your ELCON drawer connector.

Flush PCB-Mount Drawer Connectors

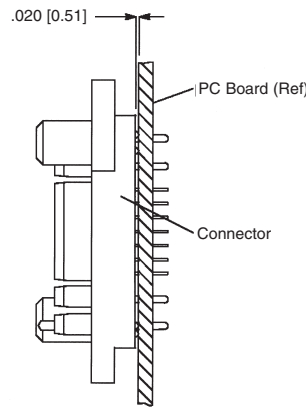

Drawer Connectors with Cabled AC IN



Connector Engagement

To provide for proper mating of the connector when the power supply unit is fully engaged into the system, the gap between the pin and socket (shown as dimension "A" in the sketch below) must be within the limit specified in the customer drawing for your ELCON drawer connector. Failure to meet this requirement may compromise contact wipe. Refer to the customer drawing for details. ELCON drawer connectors are polarized and will only mate in the correct orientation (see sketch below).

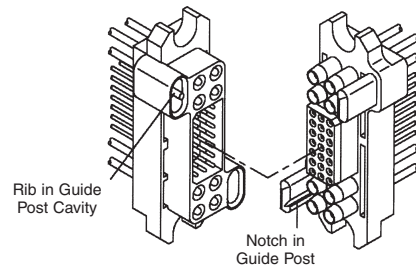
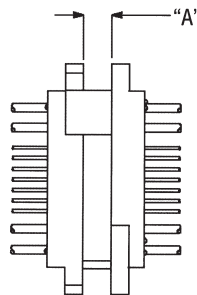

ELCON Drawer Connector Tooling

Insertion/Removal (I/R) Tools: Industry standard plastic I/R tooling is compatible with all crimp contacts for pin and socket removal. The following tools are available from Tyco Electronics.

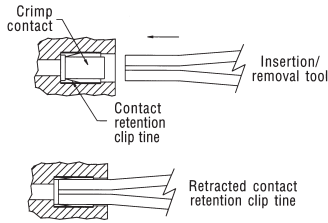

I/R Tools

Part Numbers	Size	Color Code
1643917-1	Size #20 I/R tool	Red/White
1643916-1	Size #16 I/R tool	Blue/White
1643915-1	Size #12 I/R tool	Yellow/White
1643914-1	Size #8 removal tool	Red
1643922-1	Size #4 removal tool	Blue
1643921-1	Size #0 removal tool	Light Yellow

Note: PCB tail contacts are non-removable.

Wire strip length: If inserting stranded wire into crimp style contacts, please use the table below to determine the proper strip length of the wire.

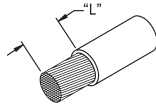

Contact Size	Wire Size AWG	"L" + .020 [0.51]	
		inches	mm
#20	#24 - #20	0.210	5.33
#16	#20 - #16	0.270	6.86
#12	#14 - #12	0.270	6.86
#8	#10* - #8	0.500	12.70
#4	#6* - #4	0.500	12.70
#0	#2* - #0	0.600	15.24

*Ref: MS3348 "Contact Bushing, Electric, Wire Barrel"

Crimp Tools: The following table lists applicable MIL-STD crimp tools for contacts



Size	Type	MIL-STD	Part Number
12 - 24	Crimp Tool	M22520/1-01	601967-1
	Turret head/locator	M22520/1-02	601967-2
8 - 10	Crimp Tool	M22520/23-01	—
	Indenter head	M22520/23-02	—
	Locator	M22520/23-09	—
4	Crimp Tool	M22520/23-01	—
	Indenter head	M22520/23-04	—
	Locator	M22520/23-11	—
0	Crimp Tool	M22520/23-01	—
	Indenter head	M22520/23-05	—
	Locator	M22520/23-13	—

Crimp Termination Wire Sizes: The following table shows crimp rear release contacts and their respective wire sizes when crimped with applicable industry standard terminal tools.

Contact Size	Wire Range	
	AWG	mm ²
#20	20 - 24	0.241 - 0.616
#16	16 - 18	0.963 - 1.23
#12	12 - 14	1.94 - 2.98
#8	10 - 8	4.74 - 8.61
#4	4 (1)	21.60
#0	1/0	53.00

Note: (1) Consult Tyco Electronics for smaller wire sizes in #4 contacts

Note: All part numbers are RoHS compliant.

ELCON Drawer Product Specifications

Materials			
Housing		Polyester, 30% glass-filled, UL 94V-0 black	
Crimp Contacts		High conductivity copper alloy	
PCB Tails		Brass	
Socket Contact Hoods (when applicable)		305 corrosion resistant steel	
Size #12 hoods, Hot-Plug		Beryllium copper	
Crown contacts		Beryllium copper	
Plating			
Size #20 and #12HP		Gold plated over nickel	
Sizes #0, #4, #8, #16 and non-HP #12		Silver plated over nickel	
Hot-Plug hoods and pin contacts		Gold plated over nickel	
Socket Contact Hoods (when applicable)		Passivated	
Mechanical			
Typical Insertion Forces of individual contacts	Size #20	0.2 lb.	0.09 kg
	Size #16	2.3 lb.	1.04 kg
	Size #12	2.9 lb.	1.32 kg
	Size #12 Hot-Plug	2.9 lb.	1.32 kg
	Size #8	4.4 lb.	2.00 kg
	Size #4	3.8 lb.	1.72 kg
	Size #0	4.7 lb.	2.13 kg
	Size #0 w/double Crown	4.8 lb.	2.18 kg
Typical Extraction Forces of individual contacts	Size #20	0.1 lb.	0.05 kg
	Size #16	0.7 lb.	0.32 kg
	Size #12	1.9 lb.	0.86 kg
	Size #12 Hot-Plug	1.9 lb.	0.86 kg
	Size #8	2.4 lb.	1.07 kg
	Size #4	3.0 lb.	1.36 kg
	Size #0	3.0 lb.	1.36 kg
	Size #0 w/double Crown	3.5 lb.	1.59 kg
Electrical			
Typical Voltage drop of individual contacts	Size #20	1.7 mV at 5A	
	Size #16	3 mV at 15A	
	Size #12	4.2 mV at 35A	
	Size #12 Hot-Plug	4.7 mV at 35A	
	Size #8	6.5 mV at 75 A	
	Size #4	8.4 mV at 125A	
	Size #0	6.3 mV at 200A	
	Size #0 w/double Crown	5.6 mV at 200A	
Insulator dielectric strength		1,500 VDC for 1 minute, per MIL-STD 1344, Method 3001	

Regulatory Agency Evaluations

Contacts	CSA-22.2 No. 0-M91 182.30 M1987 (CNR)	UL 498 and UL 1977 (USR)
AWG #20	4A / 250V	5A / 250V
AWG #16	10A / 250V	15A / 250V
AWG #12 Top Drawer	25A / 600V	35A / 600V
AWG #12 Others	25A / 250V	35A / 250V
AWG #12 with sockets	25A / 250V	35A / 250V
Size #12 hot-plug	25A / 250V	25A / 250VAC
		35A / 120V
Size #8	55A / 250V	75A / 250V
Size #0 with single or double Crown	150A / 250V	200A / 250V
Size #0 using bus bar	—	200A / 250V
Size #4	100A / 250V	125A / 250V

ELCON Drawer Series Connectors

Mini Drawer

- Dimensions** —
2.99" x 0.79" (75.9 x 20.1 mm)
- Housing Variations** — See Part Numbers
- Guides and Polarization** — Built in
- Available Contacts** —
Size 12 / 16 x 6 contacts
Size 20 x 16 contacts
- Current Rating** — Up to 35 Amps per size 12 contact
- Contact Features** — Hot-Plug size 12 contact option
- Contact Sequencing** — Multi-level for power and signal
- Contact Terminations** —
Size 12: Crimp and PCB tail
Size 16: Crimp and PCB tail
Size 20: Crimp and PCB tail

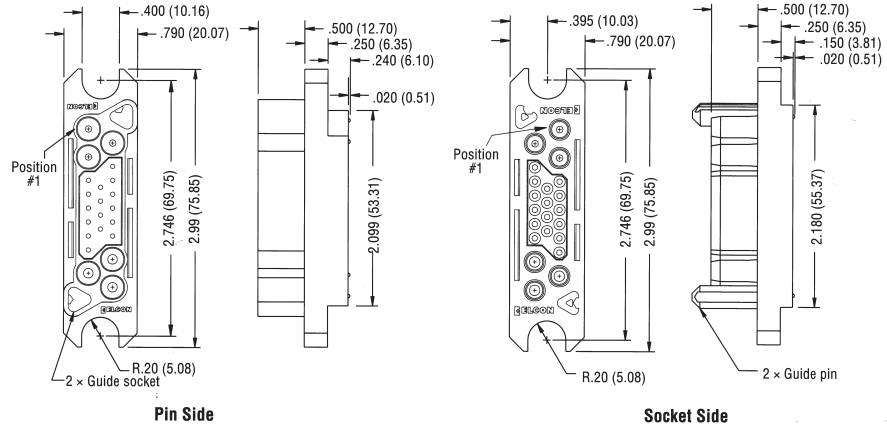

Base Housing Part Numbers

Pin Housing		Socket Housing	
1648110-1	Size 12 + Size 20 + Size 12	1648115-1	Size 12 + Size 20 + Size 12
1648111-1	Size 16 + Size 20 + Size 16	1648116-1	Size 16 + Size 20 + Size 16
1648112-1	Size 12 + Size 20 + Size 16	1648117-1	Size 12 + Size 20 + Size 16

Lower Drawer

- Dimensions** —
3.26" x 1.34" (82.8 x 34.0 mm)
- Housing Variations** — See Part Numbers
- Guides and Polarization** — Built in
- Available Contacts** —
Size 12 / 16 x 8 contacts
Size 20 x 21 contacts
- Current Rating** — Up to 35 Amps per size 12 contact
- Contact Features** — Hot-Plug size 12 contact option
- Contact Sequencing** — Multi-level for power and signal
- Contact Terminations** —
Size 12: Crimp and PCB tail
Size 16: Crimp and PCB tail
Size 20: Crimp and PCB tail

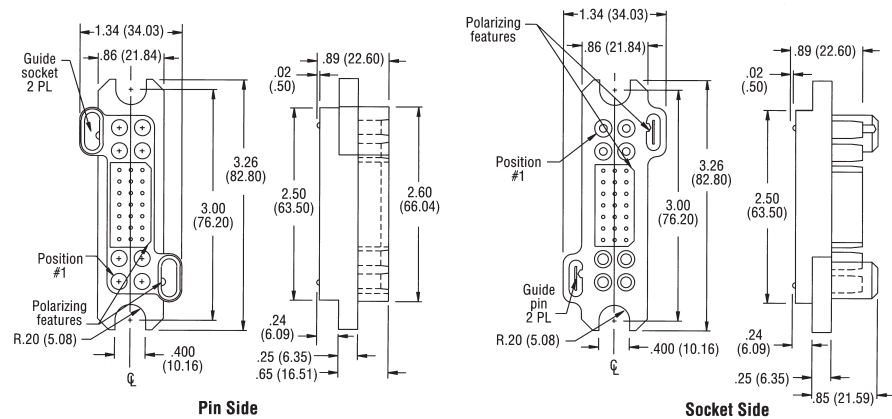

Base Housing Part Numbers

Pin Housing		Socket Housing	
1648203-1	Size 12 + Size 20 + Size 12	1648206-1	Size 12 + Size 20 + Size 12
1648204-1	Size 16 + Size 20 + Size 16	1648207-1	Size 16 + Size 20 + Size 16
1648205-1	Size 12 + Size 20 + Size 16	1648208-1	Size 12 + Size 20 + Size 16

Note: All part numbers are RoHS compliant.

ELCON Drawer Series Connectors (Continued)

75A Middle Drawer

- Dimensions** —
3.31" x 1.31" (84.1 x 33.3 mm)
- Housing Variations** — See Part Numbers
- Guides and Polarization** — Built in
- Available Contacts** —
Size 8 x 4 contacts
Size 12 x 9 contacts
Size 20 x 24 contacts
- Current Rating** — Up to 75 Amps per size 8 contact
- Contact Features** — Hot-Plug size 12 contact option
- Contact Sequencing** — Multi-level for power and signal
- Contact Terminations** —
Size 8: Crimp, internal/external thread and PCB tail
Size 12: Crimp and PCB tail
Size 20: Crimp and PCB tail

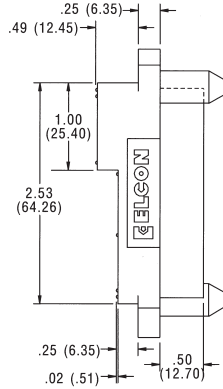
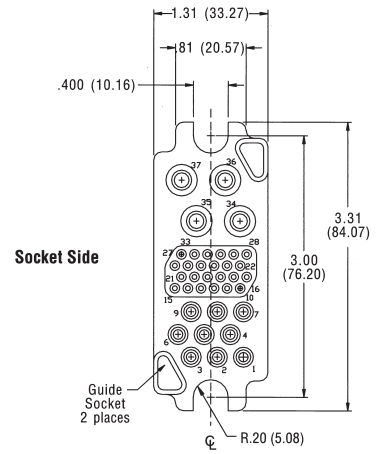
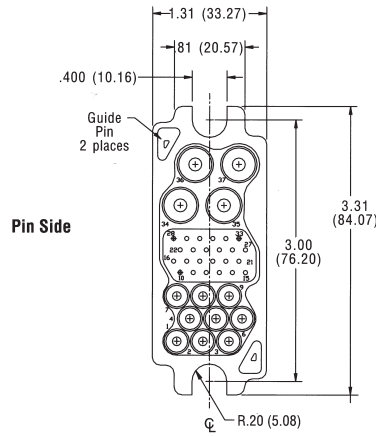

Float-Mount
Part Number 1648162-1

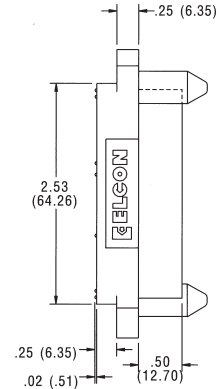

PCB-Mount
Part Number 1648163-1

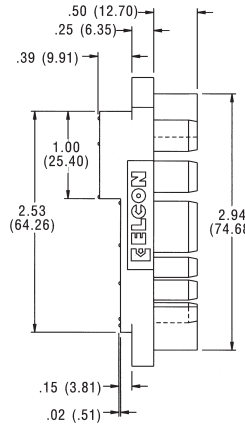

Float-Mount
Part Number 6648167-1

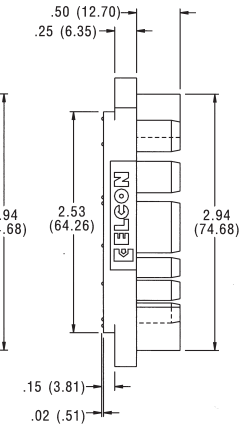

PCB-Mount
Part Number 1648168-1

Base Housing Part Numbers

Pin Housing		Socket Housing	
1648162-1	Float-Mount	6648167-1	Float-Mount w/ reinforced housing
1648163-1	PCB-Mount	1648168-1	PCB-Mount

Note: All part numbers are RoHS compliant.

ELCON Drawer Series Connectors (Continued)

125A Middle Drawer

Dimensions —

3.15" x 1.31" (80.0 x 33.3 mm)

Housing Variations — See Part Numbers

Guides and Polarization — Built in

Available Contacts —

Size 4 x 2 contacts

Size 12 x 6 contacts

Size 20 x 32 contacts

Current Rating — Up to 125 Amps per size 4 contact

Contact Features — Hot-Plug size 12 contact option

Contact Sequencing — Multi-level for power and signal

Contact Terminations —

Size 4: Crimp and internal/external thread

Size 12: Crimp and PCB tail

Size 20: Crimp and PCB tail



Base Housing Part Numbers

Pin Housing		Socket Housing	
1648151-1	Float-Mount	1648156-1	Float-Mount
1648152-1	PCB-Mount	1648157-1	PCB-Mount

Note: All part numbers are RoHS compliant.

ELCON Drawer Series Connectors (Continued)

200A Middle Drawer

Dimensions —

3.31" x 1.31" (84.1 x 33.3 mm)

Housing Variations — See Part Numbers

Guides and Polarization — Built in

Available Contacts —

- Size 4 x 2 contacts
- Size 8 x 6 contacts
- Size 12 x 3 contacts
- Size 20 x 14 contacts

Current Rating — Up to 125 Amps per size 4 contact

Contact Features — Hot-Plug size 12 contact option

Contact Sequencing — Multi-level for power and signal

Contact Terminations —

- Size 4: Crimp and internal/external thread
- Size 8: Crimp, internal/external thread and PCB tail
- Size 12: Crimp and PCB tail
- Size 20: Crimp and PCB tail

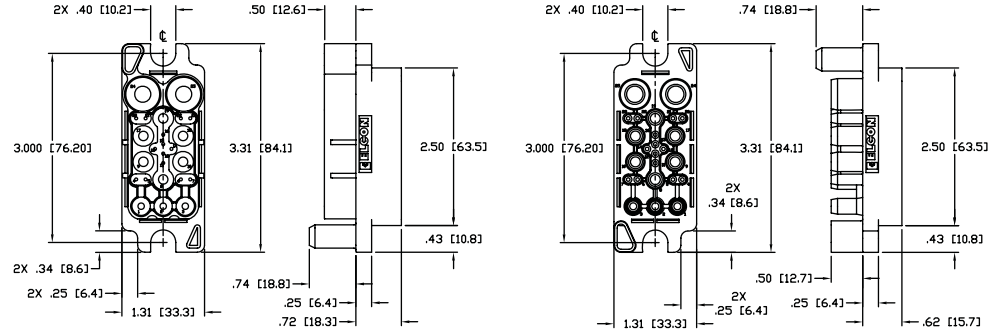

Base Housing Part Numbers

Pin Housing	Socket Housing
1648134-1	1648135-1

Square Drawer

Dimensions —

2.76" x 1.24" (70.1 x 31.5 mm)

Housing Variations — See Part Numbers

Guides and Polarization — Built in

Available Contacts —

- Size 12 x 4 contacts
- Size 20 x 36 contacts

Current Rating — Up to 35 Amps per size 12 contact

Contact Features — Hot-Plug size 12 contact option

Contact Sequencing — Multi-level for power and signal

Contact Terminations —

- Size 12: Crimp and PCB tail
- Size 20: Crimp and PCB tail

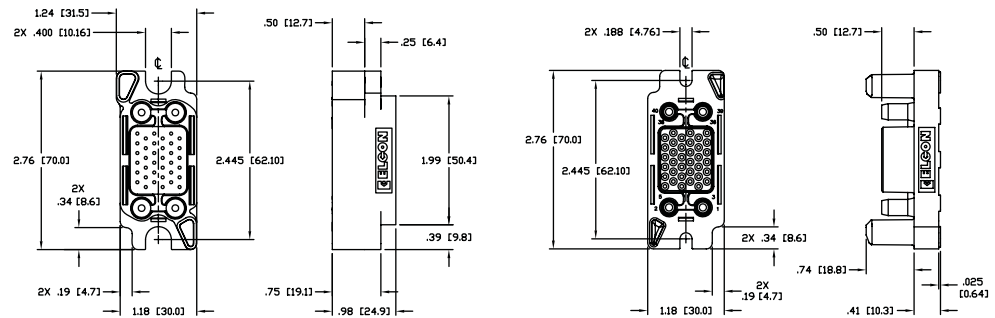

Base Housing Part Numbers

Pin Housing	Socket Housing
1648132-1	1648133-1

Note: All part numbers are RoHS compliant.

ELCON Drawer Series Connectors (Continued)

Top Drawer

Dimensions —

4.24" x 1.60" (107.8 x 40.7 mm)

Housing Variations — Various guide pin configurations available.

Guides and Polarization — Optional Steel Guide Pins with either #6-32 or M3 internal thread

Available Contacts —

- Size 0 x 2 contacts
- Size 12 x 6 contacts
- Size 16 x 12 contacts
- Size 20 x 32 contacts

Current Rating — Up to 200 Amps per size 0 contact

Contact Features — Hot-Plug size 12 contact option
Probe-proof size 0 contact option

Contact Sequencing — Multi-level for power and signal

Contact Terminations —

- Size 0: Crimp and internal/external thread
- Size 12: Crimp and PCB tail
- Size 16: Crimp and PCB tail
- Size 20: Crimp and PCB tail

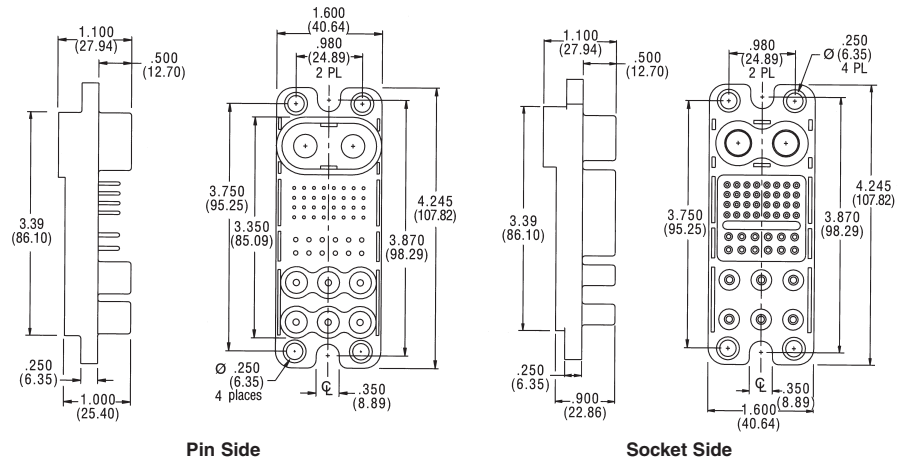

Pin Side

Socket Side

Base Housing Part Numbers

Pin Housing	Socket Housing
1648183-1	1648186-1

Optional guide posts are available for improved alignment. Consult Customer Service for details.

Double Drawer

Dimensions — 4.24" x 1.60" (107.8 x 40.7 mm)

Housing Variations — Various guide pin configurations available.

Guides and Polarization — Optional Steel Guide Pins with either #6-32 or M3 internal thread

Available Contacts —

- Size 0 x 4 contacts
- Size 12 x 11 contacts
- Size 20 x 24 contacts

Current Rating — Up to 200 Amps per size 0 contact

Contact Features — Hot-Plug size 12 contact option
Probe-proof size 0 contact option

Contact Sequencing — Multi-level for power and signal

Contact Terminations —

- Size 0: Crimp and internal/external thread
- Size 12: Crimp and PCB tail
- Size 20: Crimp and PCB tail

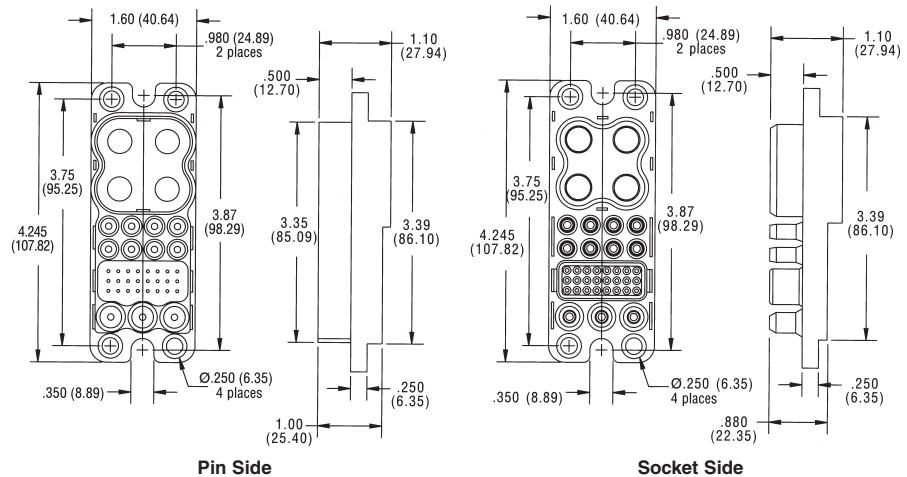

Pin Side

Socket Side

Base Housing Part Numbers

Pin Housing	Socket Housing
1648552-1	1648578-1

Optional guide posts are available for improved alignment. Consult Customer Service for details.

Note: All part numbers are RoHS compliant.

ELCON Drawer Series Connectors (Continued)

DualPower Drawer

Dimensions —

1.80" x 1.60" (45.7 x 40.7 mm)

Housing Variations — Various guide pin configurations available.

Guides and Polarization —

Optional Steel Guide Pins with either #6-32 or M3 internal thread

Available Contacts — Size 0 x 2 contacts

Current Rating — Up to 200 Amps per contact

Contact Features — Probe-proof size 0 contact option

Contact Sequencing — Standard only

Contact Terminations —

Size 0: Crimp and internal/external thread

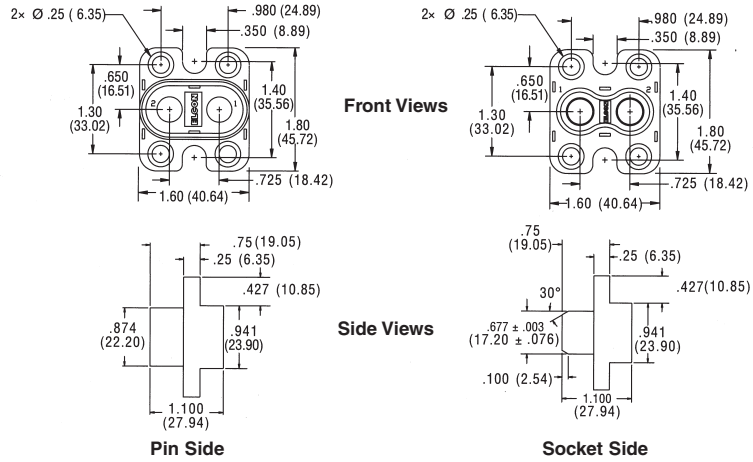

Base Housing Part Numbers

Pin Housing	Socket Housing
1648549-1	1648575-1

Optional guide posts are available for improved alignment. Consult Customer Service for details.

QuadPower Drawer

Dimensions —

2.50" x 1.60" (63.5 x 40.7 mm)

Housing Variations — Various guide pin configurations available.

Guides and Polarization —

Optional Steel Guide Pins with either #6-32 or M3 internal thread

Available Contacts — Size 0 x 4 contacts

Current Rating — Up to 200 Amps per contact

Contact Features — Probe-proof size 0 contact option

Contact Sequencing — Standard only

Contact Terminations —

Size 0: Crimp and internal/external thread

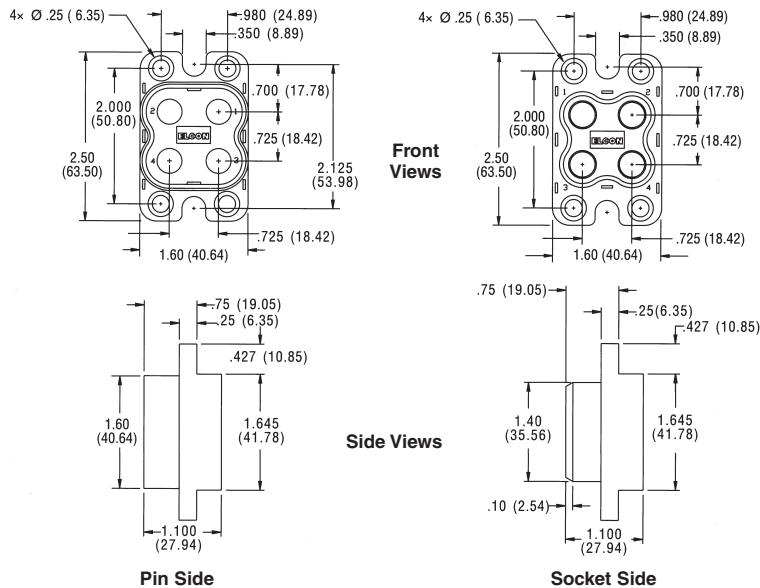

Base Housing Part Numbers

Pin Housing	Socket Housing
1648548-1	1648574-1

Optional guide posts are available for improved alignment. Consult Customer Service for details.

Note: All part numbers are RoHS compliant.

ELCON Drawer Series Connectors (Continued)

In-Line QuadPower Drawer

Dimensions —
4.84" x 1.21" (122.8 x 30.7 mm)
Housing Variations — See Part Numbers
Guides and Polarization — Built in
Available Contacts — Size 0 x 4 contacts
Current Rating — Up to 200 Amps per contact
Contact Features — Probe-proof size 0 contact option
Contact Sequencing — Standard only
Contact Terminations —
Size 0: Crimp and internal/external thread

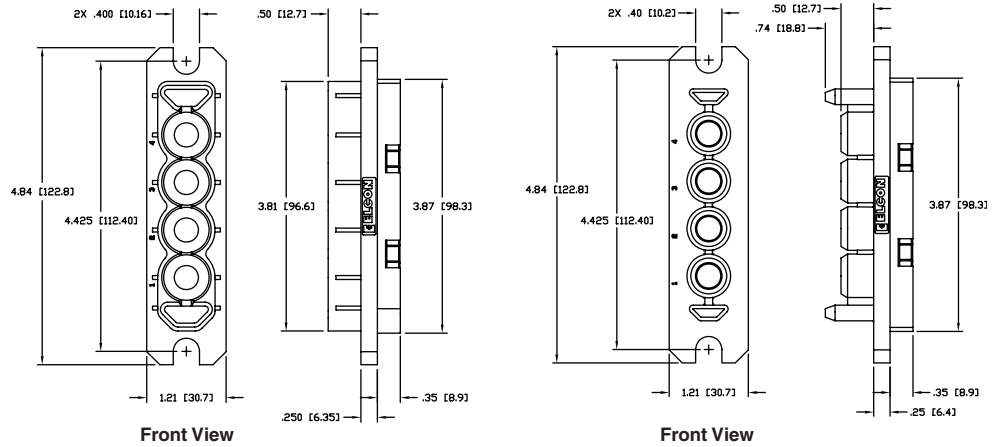

Base Housing Part Numbers

Pin Housing	Socket Housing
6651493-1	6651494-1

W5 Power Drawer

Dimensions —
3.00" x 1.18" (76.2 x 30.0 mm)
Housing Variations — See Part Numbers
Guides and Polarization — Built in
Available Contacts — Size 4 x 5 contacts
Current Rating — Up to 100 Amps per contact
Contact Features — Probe-proof size 0 contact option
Contact Sequencing — Standard only
Contact Terminations —
Size 4: Crimp and internal/external thread



Base Housing Part Numbers

Pin Housing	Socket Housing
6651457-1	6651458-1

Note: All part numbers are RoHS compliant.

ELCON Drawer Series Connectors (Continued)

P3S0 Drawer

Dimensions —

0.99" x 0.95" (25.0 x 24.0 mm)

Housing Variations — See Part Numbers

Cable Socket to Panel-Mount Pin

Guides and Polarization — Polarization only

Available Contacts — Size 12 x 3 contacts

Current Rating — Up to 35 Amps per size 12 contact

Contact Features — Hot-Plug size 12 contact option

Contact Sequencing — Multi-level for power

Contact Terminations — Size 12: Crimp only

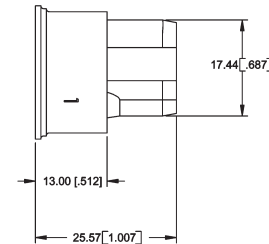
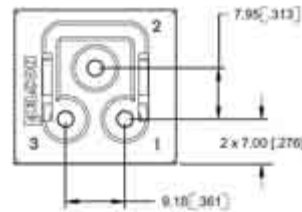
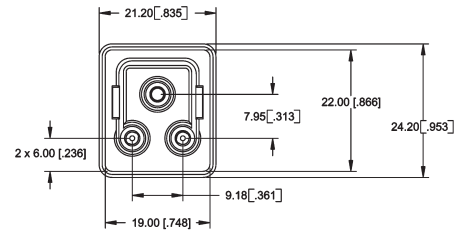
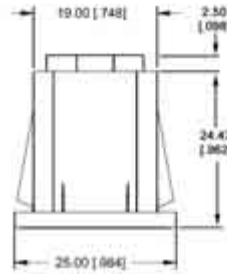

Base Housing Part Numbers

Pin Housing	Socket Housing
1766447-1	1766448-1

P4S0 Drawer

Dimensions —

1.34" x 0.76" (34.0 x 19.4 mm)

Housing Variations — See Part Numbers

Cable Pin to PCB-Mount Socket

Guides and Polarization — Polarization only

Available Contacts — Size 12 x 4 contacts

Current Rating — Up to 35 Amps per size 12 contact

Contact Sequencing — Standard only

Contact Terminations — Size 12: Crimp Pin and PCB tail Socket

Note: Supplied as kit, including contacts

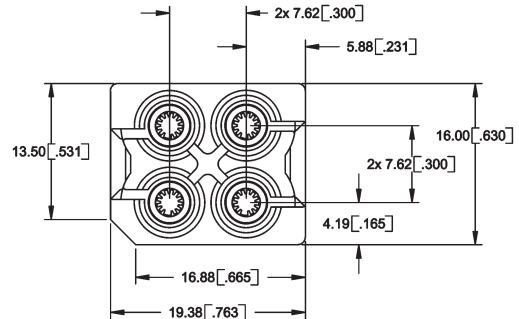
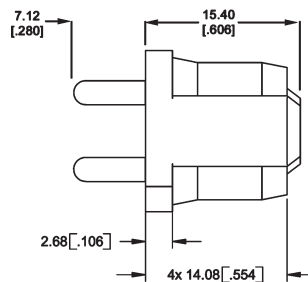
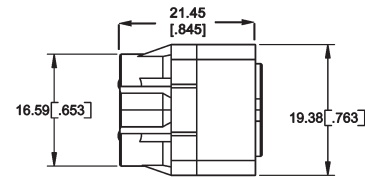
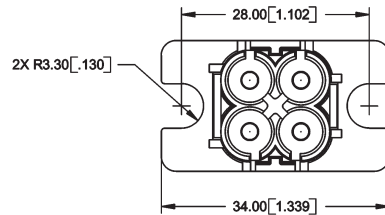

Base Housing Part Numbers

Pin Side Kit	Socket Side Kit
6766014-1	6766015-1

Note: All part numbers are RoHS compliant.

ELCON Drawer Series Connectors (Continued)

HV8P Drawer

- Dimensions** — 2.50" x 1.11" (63.5 x 28.2 mm)
- Housing Variations** — See Part Numbers
- 600 V High Voltage Design
- Guides and Polarization** — Built in
- Available Contacts** — Size 12 x 8 contacts
- Current Rating** — Up to 35 Amps per size 12 contact
- Contact Features** — Hot-Plug size 12 contact option
- Contact Sequencing** — Multi-level for power
- Contact Terminations** — Size 12: Crimp and PCB tail



Base Housing Part Numbers

Pin Housing	Socket Housing
1648127-1	1648128-1

P10S0 Drawer

- Dimensions** — 2.96" x 1.00" (75.0 x 25.4 mm)
- Housing Variations** — See Part Numbers
- Guides and Polarization** — Built in
- Available Contacts** — Size 12 x 10 contacts
- Current Rating** — Up to 35 Amps per size 12 contact
- Contact Features** — Hot-Plug size 12 contact option
- Contact Sequencing** — Multi-level for power
- Contact Terminations** — Size 12: Crimp and PCB tail

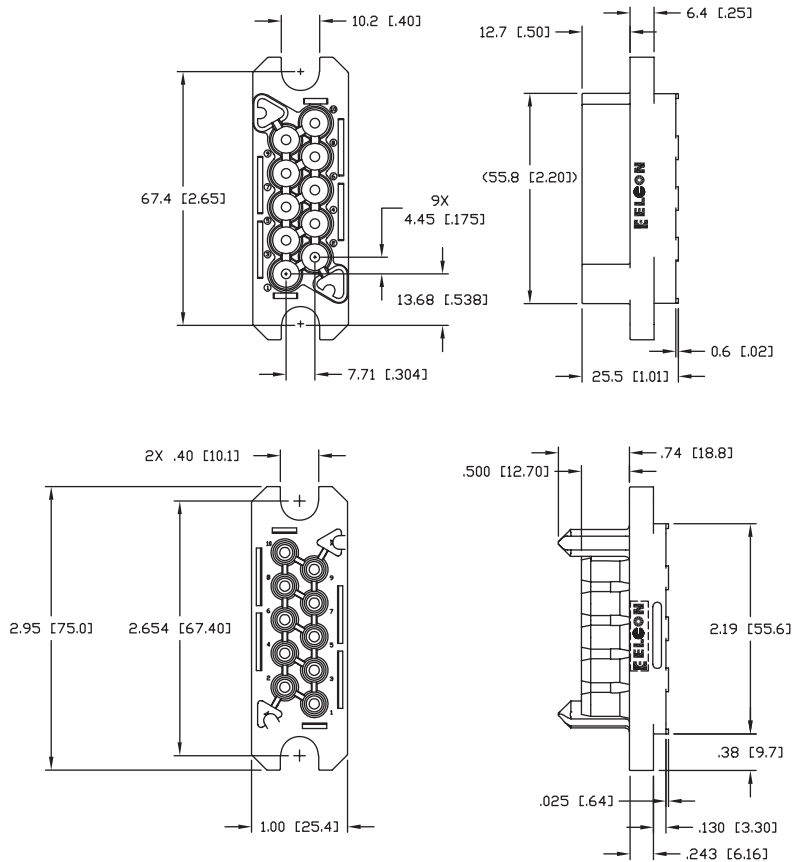

Base Housing Part Numbers

Pin Housing	Socket Housing
1648568-1	1648596-1

Note: All part numbers are RoHS compliant.

ELCON Drawer Series Connectors (Continued)

P6S18 Drawer

- Dimensions** —
5.45" x 1.35" (138.4 x 34.3 mm)
- Housing Variations** — See Part Numbers
- Guides and Polarization** — Built in
- Available Contacts** —
Size 4 x 6 contacts
Size 20 x 18 contacts
- Current Rating** — Up to 100 Amps per size 4 contact
- Contact Features** — Standard
- Contact Sequencing** — Multi-level for power and signal
- Contact Terminations** —
Size 4: Crimp and internal/external thread
Size 20: Crimp and PCB tail

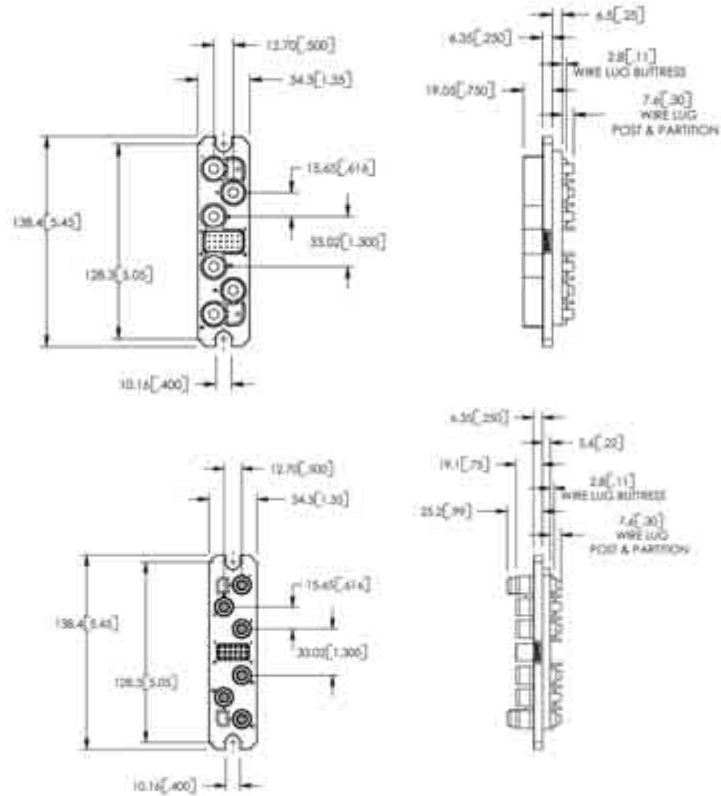

Base Housing Part Numbers

Pin Housing	Socket Housing
6766615-1	6651810-1

P10S22 Drawer

- Dimensions** —
4.12" x 0.79" (104.5 x 20.1 mm)
- Housing Variations** — See Part Numbers
- Guides and Polarization** — Built in
- Available Contacts** —
Size 12 x 10 contacts
Size 20 x 22 contacts
- Current Rating** — Up to 35 Amps per size 12 contact
- Contact Features** — Hot-Plug size 12 contact option
- Contact Sequencing** — Multi-level for power and signal
- Contact Terminations** —
Size 12: Crimp and PCB tail
Size 20: Crimp and PCB tail

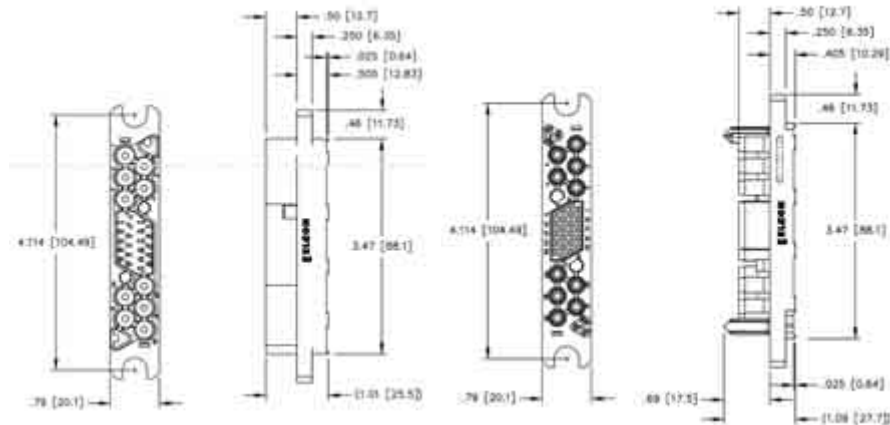

Base Housing Part Numbers

Pin Housing	Socket Housing
1648211-1	1648212-1

Note: All part numbers are RoHS compliant.

ELCON Drawer Series Connectors (Continued)

Cable Mounted Products

P12S12 Drawer

- Dimensions** —
4.31" x 0.70" (109.5 x 17.8 mm)
- Housing Variations** — See Part Numbers
- Guides and Polarization** — Built in
- Available Contacts** —
Size 16 x 12 contacts
Size 20 x 12 contacts
- Current Rating** — Up to 15 Amps per size 16 contact
- Contact Features** — Standard only
- Contact Sequencing** — Multi-level for power and signal
- Contact Terminations** —
Size 16: Crimp and PCB tail
Size 20: Crimp and PCB tail

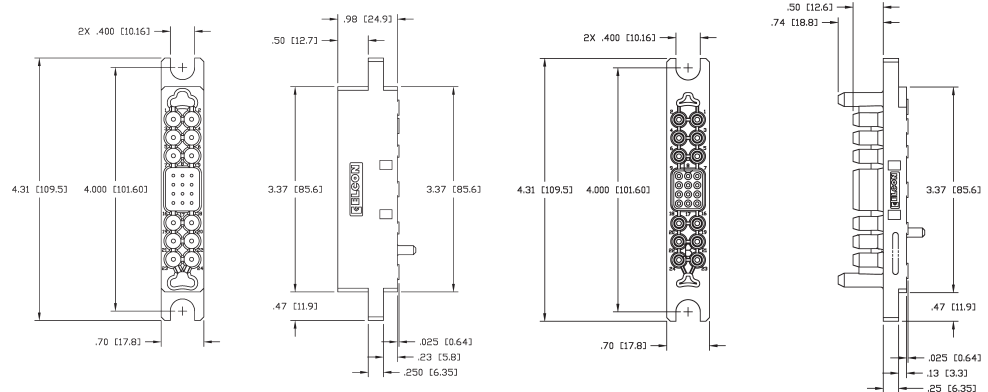

Base Housing Part Numbers

Pin Housing	Socket Housing
1651202-1	1651203-1

POS30 Drawer

- Dimensions** —
3.22" x 0.70" (81.8 x 17.8 mm)
- Housing Variations** — See Part Numbers
- Guides and Polarization** — Built in
- Available Contacts** — Size 20 x 30 contacts
- Current Rating** — Up to 5 Amps per size 20 contact
- Contact Features** — Standard only
- Contact Sequencing** — Multi-level for signal
- Contact Terminations** —
Size 20: Crimp and PCB tail

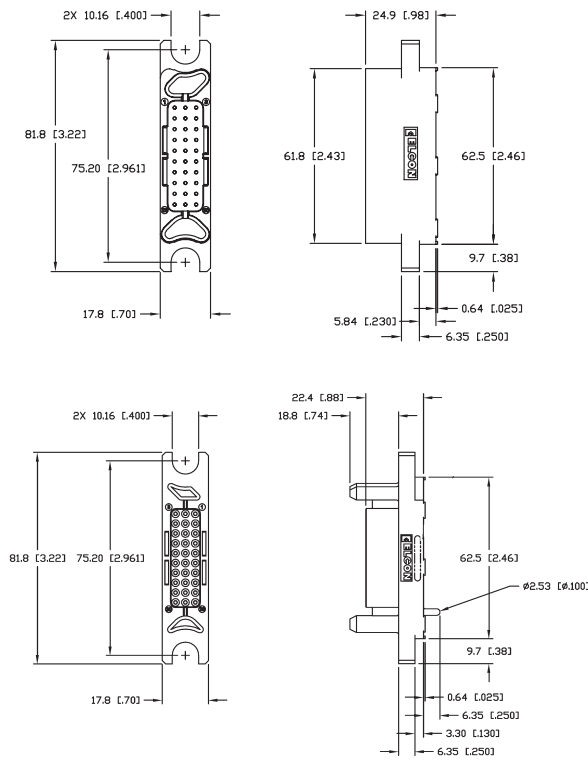

Base Housing Part Numbers

Pin Housing	Socket Housing
6651204-1	6651205-1

Note: All part numbers are RoHS compliant.

ELCON Drawer Standard Contacts

The ELCON drawer series connectors use standard contacts across the product line. This section shows the standard contacts available in different sizes and various lengths and termination styles, with their respective part numbers.

Pin Side Contacts



Contact Size #20



Contact Size #16



Contact Size #12

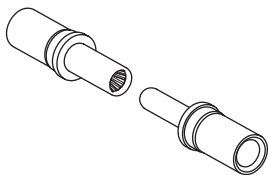

Contact Size #8

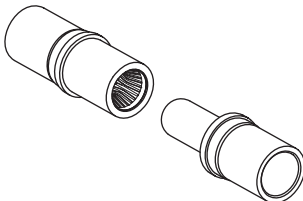

Contact Size #4

Note: All part numbers are RoHS compliant.

Contact Size #20 — For use in most drawer connectors

Termination Type	Contact Part Number	Dimensions	A	
			in	mm
Crimp, standard	1650155-1		0.32	[8.12]
Crimp, premate	1650161-1		0.47	[11.93]
Crimp, postmate	1650162-2		0.27	[6.85]
PCB tail, standard	1650283-1		0.32	[8.12]
PCB tail, premate	1650065-1		0.47	[11.93]
PCB tail, postmate	1650226-1		0.27	[6.85]

Contact Size #16 — For use in Mini Drawer, Lower Drawer, Top Drawer, and P12S12

Termination Type	Contact Part Number	Dimensions	A	
			in	mm
Crimp, standard	1766194-1		0.33	[8.38]
Crimp, premate	1766198-1		0.48	[12.19]
Crimp, postmate	1766199-1		0.29	[7.36]
PCB tail, standard	1766222-1		0.33	[8.38]
PCB tail, premate	1766223-1		0.48	[12.19]
PCB tail, postmate	1766818-1		0.29	[7.36]

Contact Size #12 — For use in Mini Drawer, Lower Drawer, 75A, 125A and 200A Middle Drawer; Square Drawer, TOP Drawer & Double Drawer; P3S0 and P4S0, HV8P, P10S0, P10S22

Termination Type	Contact Part Number		Dimensions	A	
	Gold Plated	Silver Plated		in	mm
Crimp, standard	1650153-2	1766193-1		0.43	[10.92]
Crimp, premate	1650156-2	1766195-1		0.46	[11.68]
Crimp, postmate	1650158-2	1766196-1		0.39	[9.90]
PCB tail, standard	1650060-2	1766245-1		0.43	[10.92]
PCB tail, premate	1650074-3	1766250-1		0.46	[11.68]
PCB tail, postmate	1650073-3	1766249-1		0.39	[9.90]

Note: For applications using the #12 hot-plug socket use of gold plated pins are recommended.

Contact Size #8 - For use in 75A and 200 A Middle Drawer

Termination Type	Contact Part Number	Dimensions	A	
			in	mm
Crimp, standard	1766192-1		0.43	[10.92]
Crimp, premate	1766197-1		0.48	[12.19]
Crimp, postmate	1766821-1		0.33	[8.38]
PCB tail, standard	1766262-1		0.43	[10.92]
PCB tail, premate	1766263-1		0.48	[12.19]

Contact Size #4 - For use in 125A and 200A Middle Drawer. P6S18 Drawer, W5 Power Drawer

Termination Type	Contact Part Number	Dimensions	A	
			in	mm
Crimp, Standard	1766232-1		0.51	[12.95]
1/4 - 20 x .050 DP External Thread	1766812-1		0.51	[12.95]
M5 x 0.8 x 9.6 mm DP M5 Internal Thread	1766283-1		0.51	[12.95]

ELCON Drawer Standard Contacts (Continued)

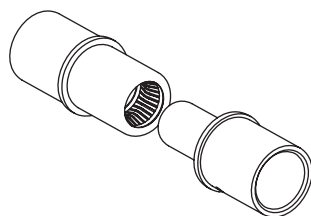
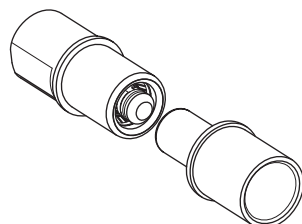
Pin Side Contacts (Continued)

Contact Size #0

**Contact Size #0
Probe-proof**
Contact Size #0¹ - For use in Top Drawer, Double Drawer, DualPower & QuadPower, In-Line QuadPower

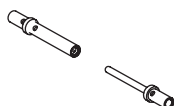
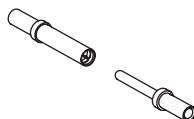
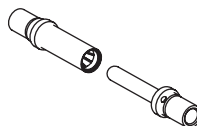
Termination Type	Contact Part Number	Dimensions	A	
			in	mm
Crimp	1766811-1		0.495	[12.57]
Probe-proof crimp ²	1766819-1		0.430	[10.92]
1/4 - 20 x .050 DP Internal thread	1766230-1		0.495	[12.57]
M6 x 1 x 12.7 mm DP Internal thread	1766274-1		0.495	[12.57]
1/4 - 20 x .050 DP Probe-proof/internal thread ²	1766269-1		0.430	[10.92]
M6 x 1 x 12.7 mm DP Probe-proof/Internal thread ²	1766275-1		0.430	[10.92]
1/4 - 20 x .050 DP External thread	1766268-1		0.495	[12.57]
M6 x 1 x 12.7 mm DP External thread	1766231-1		0.495	[12.57]
1/4 - 20 x .050 DP Probe-proof/external thread ²	1766270-1		0.430	[10.92]
M6 x 1 x 12.7 mm DP Probe-proof/external thread ²	1766276-1		0.430	[10.92]

Notes: ¹Contact Tyco Electronics for alternate contact terminations.
²Use only with probe-proof socket contacts.
³Crimp and threaded contact are insertable/removable.

Socket Side Contacts

Contact Size #20

Contact Size #16

Contact Size #12
Contact Size #20

Termination Type	Contact Part Number
Crimp	1648325-1
PCB Tail	1648382-1

Contact Size #16

Termination Type	Contact Part Number
Crimp	6648319-1
PCB Tail	6648383-1

Contact Size #12

Termination Type	Contact Part Number
Crimp	6648318-1
Hot-Plug Crimp	1648384-1
PCB Tail	6648374-1
Hot-Plug PCB Tail	1648387-1

Note: For applications using the #12 hot-plug socket, the use of gold plated pins are recommended (see page 80).

Note: All part numbers are RoHS compliant.

ELCON Drawer Standard Contacts (Continued)

Socket Side Contacts



Contact Size #8

Contact Size #8	
Termination Type	Contact Part Number
Crimp	6648317-1
PCB Tail	6648400-1

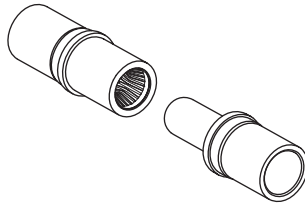

Contact Size #4

Contact Size #4	
Termination Type	Contact Part Number
Crimp, Standard	6648434-1
1/4 - 20 x .050 DP External Thread	6648435-1
M5 x 0.8 x 9.6 mm DP M5 Internal Thread	6648335-1

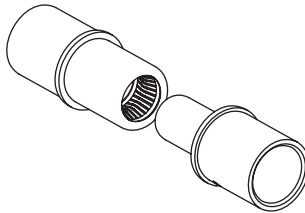

Contact Size #0

Contact Size #0¹	
Termination Type	Contact Part Number
Crimp	6648405-1
Probe-proof crimp ²	6648418-1
1/4 - 20 x .050 DP Internal thread	6648416-1
M6 x 1 x 12.7 mm DP Internal thread	6648428-1
1/4 - 20 x .050 DP Probe-proof/internal thread ²	6648419-1
M6 x 1 x 12.7 mm DP Probe-proof/Internal thread ²	6648429-1
1/4 - 20 x .050 DP External thread	6648417-1
M6 x 1 x 12.7 mm DP External thread	6648430-1
1/4 - 20 x .050 DP Probe-proof/external thread ²	6648420-1
M6 x 1 x 12.7 mm DP Probe-proof/external thread ²	6648431-1

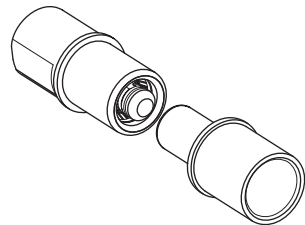

**Contact Size #0
Probe-proof**

Notes: ¹Contact Tyco Electronics for alternate contact terminations.
²Use only with probe-proof Pin contacts.
³Crimp and threaded contact are insertable/removable.

Non-Standard Contacts

Contacts with pin lengths and terminations other than standard are available. Consult customer service if your design requires contacts different from the ones shown in this catalog.

Note: All part numbers are RoHS compliant.

AMP Miniature Power Drawer (MPD) Connectors

Product Facts

- High mating cycle life
- Low Mating and Un-mating force (< 0.2lbs per contact)
- Single-piece molded housing
- Molded-in guide pins provide generous blind-mateability
- Sizes: 3 – 10 positions
- Compact size is ideal for distributed DC power applications
- Two Levels of contact sequencing
- One contact for either solder or press-fit termination
- Hardware — Less or traditional shoulder bolt mounting
- Minimum of 3 mm contact wipe on shortest power contact
- All MPD connectors in this section are RoHS compliant

Specifications

Up to 16 Amps per contact
 250 mating cycle durability
 +/- 1.25 mm radial mis-alignment capability. (Total float is 2.5 mm!)

1.6 mm sequencing distance — ideal for modular sheet metal construction applications

Minimum of 3 mm contact wipe on shortest power contact

Maximum continuous operating temperature — 105°C

UL 94 V-0 High-temperature thermoplastic housings

Technical Documents

Product Specification

108-1998

Application Specification

114-13067



The miniature power drawer connector combines a high density power interface in a blind-mateable wire-to-board connector. The MPD contact interface has been previously qualified to requirements similar to BellCore GR-1217 in board-to-board applications. Now available in a crimp-to-wire version, the contacts are rated for up to 15 Amps on 14 AWG wire. In addition, the MPD contacts are designed to meet UL 1977 hot-plug requirements for up to 7.8 Amps at 48VDC.

The connection consists of a vertical pcb mountable receptacle and a panel-mounted floating plug. The vertical receptacle pcb tails are designed for use in either through hole solder or press-fit applications. The float-mount plug is easily installed from the inside of the chassis without any additional hardware, lending itself to easy assembly of pre-made cable assemblies. Additionally, the staggered wire exit pattern permits the maximum number of contact interfaces in the least amount of connector volume.

The compact design is ideal for bringing power to small rack-mounted devices such as 1U computer servers and telecommunications switches. The 3 mm center-line satisfies UL 1977 safety requirements for 48 VDC distributed power applications. For higher voltage applications such as AC input, the contacts can be selectively loaded to handle up to 300 V AC or DC.

AMP Miniature Power Drawer (MPD) Connectors (Continued)

Crimp Contacts

Current Ratings

Standard Power — 10 Amps

High Power — 16 Amps

Material and Finish

Standard Power:

Crimp Blade Contacts — Brass

Receptacle Contacts — Phos. Bronze.

Finish — 0.38µm Gold over 1.27µm Nickel

High Power:

Blades — High Conductivity Cu Alloy

Receptacle — High Conductivity Cu Alloy

Finish — 1.27µm Gold over 1.27µm Nickel

Contact Mating Length (Min.) —

Type A — 4.6 mm

Type B — 3.0 mm

Hot-Pluggability (With High Current Contacts only) —

250 Cycles — 7.8 Amps @ 48VDC

Note: All contacts are Sn plated in the crimp barrel or Sn in pcb interface



PRO-CRIMPER Hand Tool
Part Number 91363-1

Crimp Blade Contacts

Wire Size	Type	Cycles	Mating Length	Part Number Strip Form	Applicator	Hand Tool
16-20 AWG	Standard Power	100	A	1489128-8	1385248-3	91363-1
			B	1489128-7		
	High Power	250	A	1-1489128-0		
			B	1489128-9		

Heavy Duty Miniature (HDM) Applicator for AMP-O-LECTRIC Model G Machine - #1385248-3.
PRO-CRIMPER Hand Tool #354940-1, Die set # 91363-2

Cable Mounted Products

Plugs and Receptacles

Materials

UL 94V-0 Thermoplastic

105°C Max. Operating temperature

Note: Vertical PCB Mt. Receptacles supplied with press-fit ACTION PIN contacts.



Number of Positions	Part Number			
	Panel-Mount Plug		PCB-Mount Receptacles	
	Snap-In	Shoulder Bolt	Standard Power	High Current
3	1489127-1	—	1489715-1	1-1489715-1
4	1489127-2	1489701-1	1489715-2	1-1489715-2
5	1489127-3	—	1489715-3	1-1489715-3
6	1489127-4	—	1489715-4	1-1489715-4
7	1489127-5	—	1489715-5	1-1489715-5
8	1489127-6	—	1489715-6	1-1489715-6
9	1489127-7	—	1489715-7	1-1489715-7
10	1489127-8	—	1489715-8	1-1489715-8

Note: All part numbers are RoHS compliant.

Hybrid Blind-Mate Drawer Connectors

Product Facts

- High current circuits and signal circuits can be mixed in the same connector
- High current circuits use MIC connector contacts located at four corners of the housing
- Signal circuits use Standard Drawer Connector contacts
- 24 positions
- Hermaphroditic housing can be mated with top and bottom turned while maintaining polarity

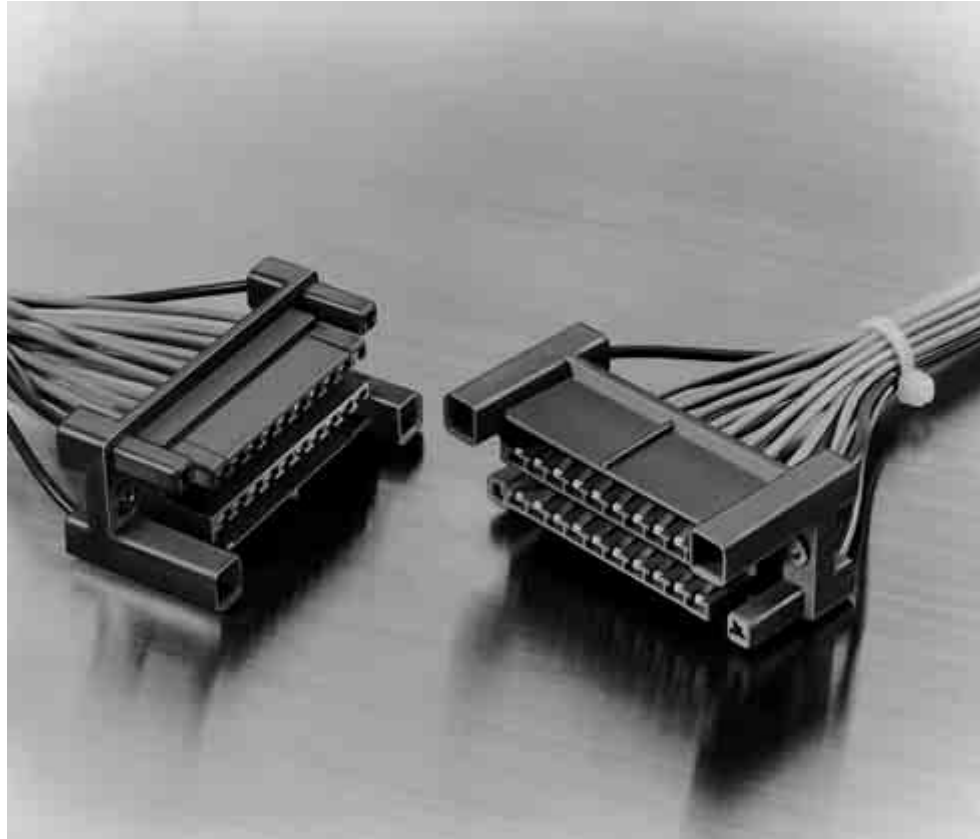

Hybrid Drawer Connectors offer high current and signal circuits mixed in the same connector system.

High current circuits use MIC connector contacts which are located at the four corners of the housing.

Signal circuits use the same

hermaphroditic crimp snap-in contacts that are used in the Standard Drawer Connector.

The hermaphroditic housings are available in a popular 24-position size. These housings can be mated with top and bottom turned while maintaining polarity.

Performance Specifications

Voltage Rating — 250 VAC

Current Rating (Max.) —

Signal Circuit (Drawer);
4 Amps — 24 AWG [0.2 mm²] Wire
5 Amps — 22 AWG [0.3-0.4 mm²] Wire
7 Amps — 20 AWG [0.5-0.6 mm²] Wire
Power Circuit (MIC);
10 Amps

Low Level Resistance —

Signal Circuit (Drawer);
10 milliohms max. (Initial)
20 milliohms max. (Final)
Power Circuit (MIC);
3 milliohms (Initial)
6 milliohms (Final)

Dielectric Withstanding Voltage —

5000 milliohms (Initial)
2000 milliohms (Final)

Operating Temperature —

-20°C to +120°C

Hybrid Blind-Mate Drawer Connectors (Continued)

Housings
(Hermaphroditic),
24 Positions

Material

Housing — Glass-filled polybutylene terephthalate (PBT), blue

Bushing — Brass, zinc-plated

Related Product Data

Performance Specifications — page 85

MIC Contacts — page 87

Crimp Snap-In Contacts — page 87

Technical Documents

Product Specification
108-5371

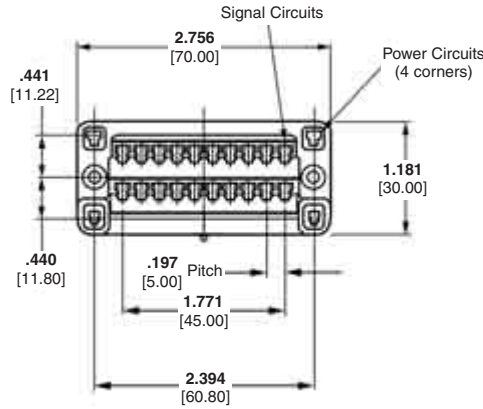

Note: Reverse figures show circuit numbers.

(Example = $\frac{A1}{81B}$ The hole used for No. 1 circuit is used for No. 13 on the reverse side.)



Floating of Bushing	Housing Part Numbers
Up- and downward = 0.05 [.002] Circumferential = 0.14 [.006]	5176916-1
Up- and downward = 0.30 [.012] Circumferential = 0.80 [.031]	5176916-2

Upward and downward = Axial clearance
Circumferential = Floating

Recommended Panel Cutout



*Dimensions applicable for rear mounting.

Note: All part numbers are RoHS compliant.

Hybrid Blind-Mate Drawer Connectors (Continued)

**MIC Contacts
(Used for Power Circuits)**

Material and Finish

Phosphor bronze, plated .000030 [0.00076] gold in contact area, remainder of contact gold flash, with entire contact underplated nickel

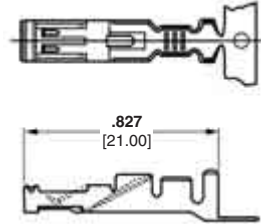

Related Product Data

Performance Specifications—page 85

Housings—page 86

Technical Documents

Instruction Sheets
408-089J, 408-369J, 408-370J

Wire Size Range		Insulation Diameter	Part Numbers			
AWG	mm ²		Receptacle Contact		Hand Tool	Applicator
		Strip Form	Loose Piece			
20-14	0.5-2.0	.087-.134 2.20-3.40	170286-4	170289-3	755338-1* 755339-1	567151-X**

*Part Number 755338-1 is used on wire for automotive application; Part Number 755339-1 is used on other types of wire.

**Call Tyco Electronics for applicators.

Extraction Tool Part Number 723735-1

**Crimp Snap-In Contacts
(Hermaphroditic, Used for Signal Circuits)**

Material and Finish

Phosphor bronze, plated gold in contact area (for length of .236 [6.0] from tip), with entire contact underplated nickel

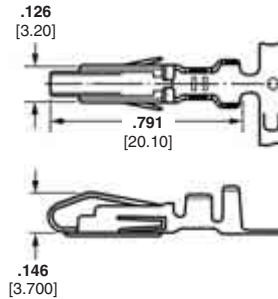

Related Product Data

Performance Specifications—page 85

Housings—page 86

Technical Documents

Instruction Sheets
408-097J, 408-151J

Wire Size Range		Insulation Diameter	Contact		Applicator for AMP-O-ELECTRIC Machine*	Hand Tool
AWG	mm ²		Strip Form	Loose Piece		
24-20	0.2-0.6	.060-.077 1.50-1.95	170311-1	170313-1	567324-2	91591-1
20-16	0.5-1.4	.071-.130 1.80-3.30	170484-1	170485-1	567241-2	91590-1

*Applicators are for Model "K" machines. Consult Tyco Electronics for applicators for other bench machines and lead-making machines.

Notes: For applicable wire, use wire specified in UL 1015 or 1007.

Extraction Tool Part Number 723986-1

Tab Contacts

Material and Finish

Brass, plated .000030 [0.00076] gold in contact area, with entire contact underplated nickel

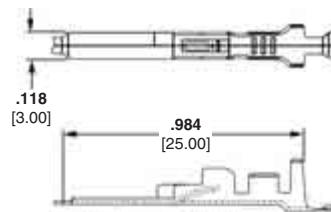

Related Product Data

Performance Specifications—page 85

Housings—page 86

Technical Documents

Instruction Sheets
408-144J, 408-369J, 408-370J

Wire Size Range		Insulation Diameter	Part Numbers		Hand Tool
AWG	mm ²		Tab Contact		
		Strip Form	Loose Piece		
20-14	0.5-2.0	.087-.134 2.20-3.40	170221-4	170222-3	755338-1* 755339-1

*Part Number 755338-1 is used on wire for automotive application; Part Number 755339-1 is used on other types of wire.

Extraction Tool Part Number 724763-1

Note: All part numbers are RoHS compliant.

Special Blind-Mate Drawer Connectors (uses AMP-LEAF Contacts)

Product Facts

- Blind-mate connectors accept AMP-LEAF crimp snap-in and solder dip contacts
- Contacts are phosphor bronze, gold-over-nickel plated
- 6 and 10 positions
- Housings made of polybutylene terephthalate (PBT)



Special blind-mate drawer connectors are available in 6- and 10-position configurations and provide wire-to-board and wire-to-wire connection capabilities. These connectors offer the integrity of AMP-LEAF contacts with maximum travel wiping action.

Housings feature molded-in guide pins and diagonally aligned sockets for correct polarization and to facilitate blind-mating. The PC header guide pins extend through the PC board to secure the header to the board prior to soldering.



6-Position Socket Housing
(Accepts AMP-LEAF Crimp Snap-In Contacts)



6-Position PC Board Header Housing
(Fully loaded with AMP-LEAF Solder Dip Contacts)



10-Position Socket Housing
(Accepts AMP-LEAF Crimp Snap-In Contacts)



10-Position Header Housing
(Accepts AMP-LEAF Crimp Snap-In and Solder Dip Contacts)

Performance Specifications

Current Rating —
4 Amps (max.) — 26-22 AWG
[0.12-0.4 mm²] wire

Voltage Rating — 50 VDC

Temperature Rating —
-10°C to +80°C

**Mounting Screw
(2 Required per Socket
Housing)**

Part Number 343404-1

Material and Finish

Steel, plated bright zinc chromate

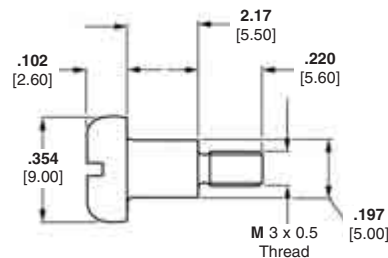

Note: All part numbers are RoHS compliant.

Special Blind-Mate Drawer Connectors (Continued)

**Socket Housing,
6 Positions**

Part Number 343886-1

Accepts the following AMP-LEAF
Crimp Snap-In Contacts:

Part Number 583990-3 (loose piece)
Part Number 583204-2 (strip form)

Contacts must be ordered
separately.

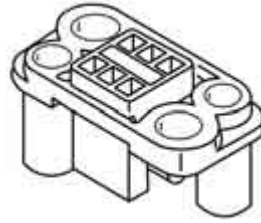

Recommended Panel Cutout

Material

Glass-filled polybutylene terephthalate
(PBT), black



**PC Board Header Housing,
6 Positions with Board
Retention**

Part Number 343887-1

Accepts AMP-LEAF Crimp Snap-In
Contact Part Number 343371-1
and Solder Dip Contact
Part Number 583294-2

Contacts must be ordered
separately; refer to contact
specification pages for details.

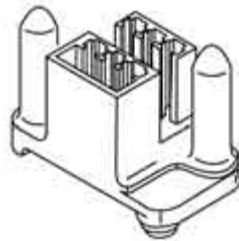

Recommended PC Board Layout

Material

Glass-filled polybutylene terephthalate
(PBT), black

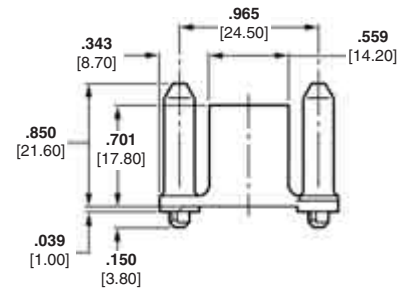
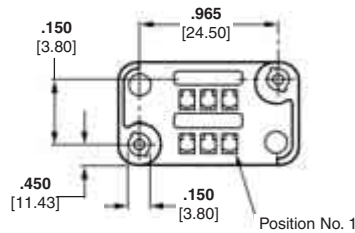

Note: All part numbers are RoHS compliant.

Special Blind-Mate Drawer Connectors (Continued)

**Socket Housing,
10 Positions**

Part Number 343348-1

Accepts the following AMP-LEAF
Crimp Snap-In Contacts:

Part Number 343371-1 (strip form)
Part Number 583204-2 (strip form)

Contacts must be ordered
separately.

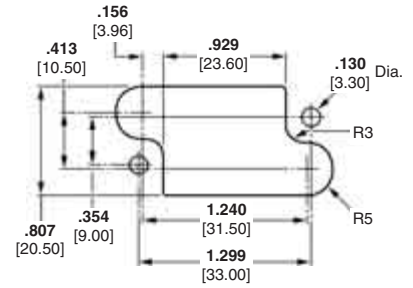
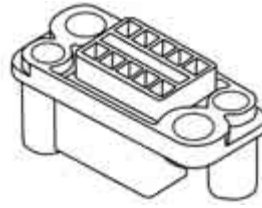

Recommended Panel Cutout

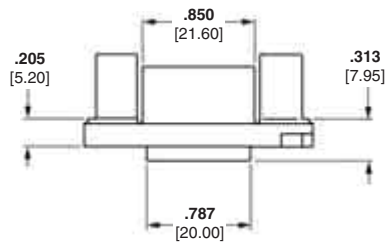

Material

Glass-filled polybutylene terephthalate
(PBT), black

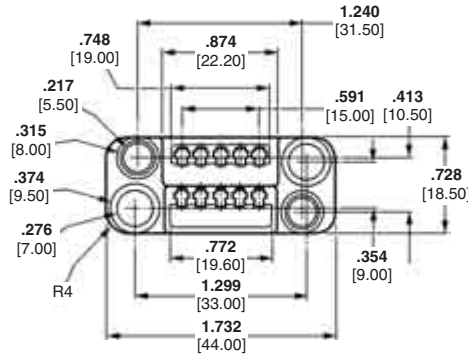

**Header Housing,
10 Positions**

Part Number 343347-1

Accepts AMP-LEAF Crimp Snap-In
Contact Part Number 343371-1
and Solder Dip Contact
Part Number 583294-2

Contacts must be ordered
separately: refer to contact
specification pages for details.

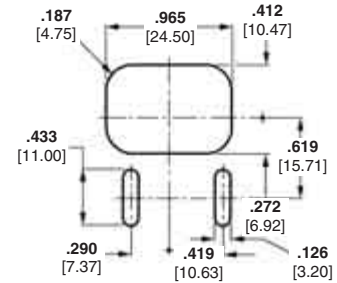
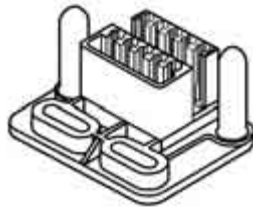

Recommended Panel Cutout

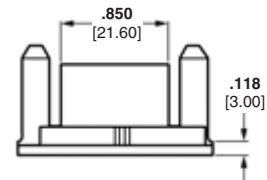

Material

Glass-filled polybutylene terephthalate
(PBT), black

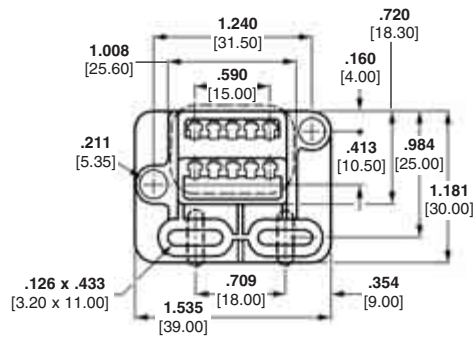

Note: All part numbers are RoHS compliant.

Special Blind-Mate Drawer Connectors (Continued)

Crimp, Snap-In Contacts

Material and Finish

Phosphor bronze, plated as follows:

Plating A — .000100-.000200 [0.00254-0.00508] tin (lubricant must be used)

Plating B — .000030 [0.00076] min. gold in mating area, gold flash on remainder of contact, with entire contact underplated .000050 [0.00127] min. nickel

Plating C — .000015 [0.00038] min. gold in mating area, gold flash on remainder of contact, with entire contact underplated .000050 [0.00127] min. nickel

Plating D — .000030 [0.00076] min. gold over .000050 [0.00127] min. nickel in mating area, remainder of contact gold flash over .000015 [0.00038] min. nickel

Plating E — .000030 [0.00076] min. gold in mating area, with entire contact underplated .000050 [0.00127] min. nickel

Plating F — .000015 [0.00038] min. gold in mating area, with entire contact underplated .000050 [0.00127] min. nickel

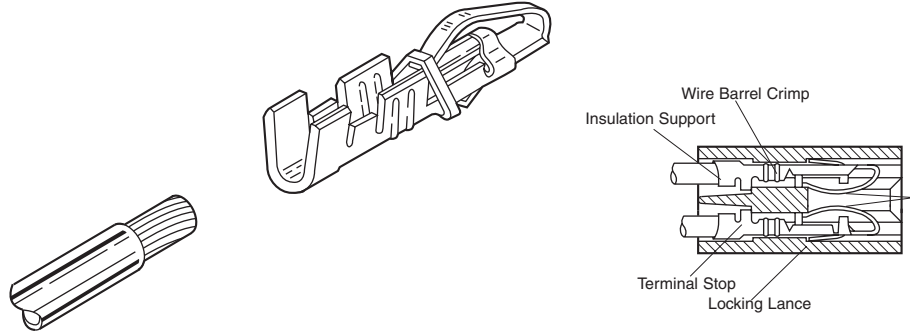

Wire Range AWG/mm ²	Insulation Range		Contact		Contact Finish	Applicator for AMP-O-LECTRIC Machine*	Hand Tool
	Single Wire	Double Wire	Loose Piece	Strip Form			
26-22 0.12-0.4	.050-.064 1.27-1.63	—	583990-3	583204-2	B	466366-2	90028-3
			—	343371-1	D		
			—	583361-2	A		
			583989-3	583361-3	B		
22-18 0.3-0.9	.055-.080 1.40-2.03	.120 3.05 Max.	583989-4	583361-4	C	466367-2	90017-3 (1 #22-20) 90028-3 (2 #22) 90101-3 (1 #20)
			—	583555-4	E		
			—	583555-6	F		
			583991-3	60151-6	B		
16 1.25-1.40	.108 2.74 Max.	.080-.160 2.03-4.06	583991-3	60151-6	B	466368-2	90031-8 (2 #18) 90101-3 (2 #20) 90101-3 (1 #16)
			—	—	—		

*Applicators are for AMP-O-LECTRIC Model "K" machines. Consult Tyco Electronics for applicators for other bench machines and lead-making machines.

- Notes:**
- Shorting contacts are available, consult Tyco Electronics.
 - Contacts and housings to accommodate .093 [2.36] thick PC boards can be made available, consult Tyco Electronics.

Technical Documents

Product Specifications

108-9013, 108-9043

Application Specification

114-9003

Instruction Sheets

408-6591, 408-7045, 408-7622, 408-7623, 408-7624, 408-7625, 408-7626

Crimp Inspection Sheet

CI 8050-33

Hand Crimping Tool



Contact Extraction Tool



Extraction Tool	Part Number	
	Used with Housings	
465195-1	480110-2, -5	
	480142-2, -3	
	582140-5	
	582147-5	
	582264-2	
	582500-2	
	582963-2	
	583167-3	
	583280-1	
	583617-1	
	583680-1	
	583685-1	
	583722-1	
	583723-1	
583724-1		
583725-1		
583726-1		
465195-2	480133-2	

Dummy Contact

Material

Phosphor bronze

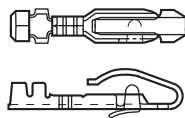

- Plain Finish—
Part Number 66084-1
Tin Finish—
Part Number 66084-2
Gold Finish—
Part Number 66084-3

Technical Documents

Instruction Sheet 408-7037

Note: All part numbers are RoHS compliant.

Standard Blind-Mate Drawer Connectors

Product Facts

- Designed for rack and panel applications
- Durable—withstands multiple mating/unmating
- Low insertion and withdrawal force
- Hermaphroditic contacts
- Accepts signal and power contacts
- Provides excellent creep distance
- Mated connectors dust-proof
- Configurations available in 8, 12, 16, 20 and 24 positions
- Contacts accept wire sizes 24-14 AWG [0.2-2.0 mm²]
- Accept wire insulation diameter — .059-.154 [1.5-3.9]
- Recognized under the Component Program of the Underwriters Laboratories Inc. 



Drawer connectors are designed as an economical rack and panel connector. They are used in copying machines, control panels, power distribution boards, industrial equipment, power supplies and other electronic equipment.

Blind-mate drawer connectors feature excellent durability and provide low insertion and withdrawal force. Leaf-type hermaphroditic contacts ensure reliable, positive contact.

Contacts are on .197 [5.00] centerlines for signal circuits, and .260 [6.60] centerlines for power circuits (2-circuits at each end of the double row of contacts) for a total of 4. Row-to-row spacing is .390 [9.90].

Housings are made of UL 94V-0 rated thermoplastic and feature molded-in guide pins and sockets for positive connector mating.

Other features include wire outlets which provide for sufficient creep distance, plus mated assemblies are completely dust-proof.

Additional economies are achieved through the use of strip-form contacts suitable for high-speed automatic machine terminations. For prototype, maintenance and repair applications, contacts are available in loose piece for easy termination with Tyco Electronics hand crimping tools.

Performance Specifications

Voltage Rating — 250 VAC

Current Rating —

- 4 Amps — 24 AWG [0.2 mm²] Wire
- 5 Amps — 22 AWG [0.3-0.4 mm²] Wire
- 7 Amps — 20 AWG [0.5-0.6 mm²] Wire
- 8 Amps — 18 AWG [0.8-0.9 mm²] Wire
- 12 Amps — 16 AWG [1.25-1.4 mm²] Wire
- 15 Amps — 14 AWG [2.0 mm²] Wire

Contact Resistance —

- 10 milliohms max. (Initial)
- 20 milliohms max. (Final)

Insulation Resistance —

- 5000 milliohms min. (Initial)
- 2000 milliohms min. (Final)

Dielectric Withstanding Voltage — 2000 VAC/1 minute

Operating Temperature —

–20°C to +120°C (Includes T-Rise)

Insertion/Extraction Force —

- Insertion—4 kg max. (Initial) —
- 16-position
- Extraction—0.7 kg min. (Initial) —
- 16-position

Durability —

Tested to 1000 Mate/Unmate cycles

Standard Blind-Mate Drawer Connectors (Continued)

Plug Connectors, PCB-Mount

Material and Finish

Housing — Glass-filled polybutylene terephthalate (PBT), blue, 94V-0 rated
Contacts — Phosphor bronze, plated gold in contact area over nickel underplating; board-mount tails are brass, plated tin over steel underplating

Related Product Data:

Performance Specifications — page 92
Mating Receptacles — page 94

Technical Documents

Product Specification
 108-5125
Application Specification
 114-5044

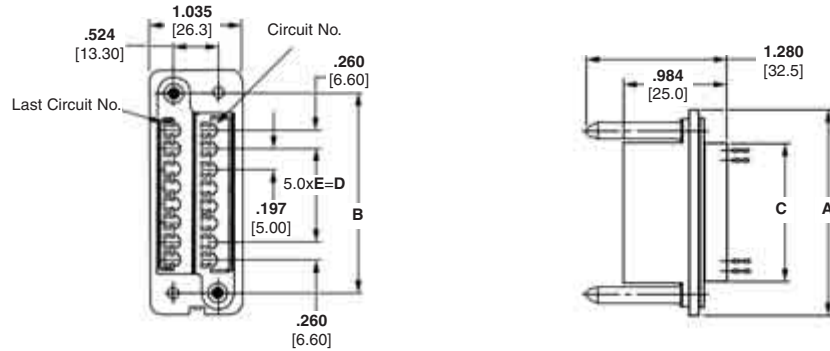

No. of Pos.	Dimensions					Plug Connector Part Numbers
	A	B	C	D	E	
8	2.016 51.2	1.500 38.0	1.055 26.8	.197 5.00	1	172653-2
12	2.409 61.2	1.890 48.0	1.449 36.8	.591 15.0	3	172653-3
16	2.803 71.2	2.283 58.0	1.843 46.8	.984 25.0	5	172653-1

Note: To ensure proper contact alignment, connectors must be mated during the soldering process.

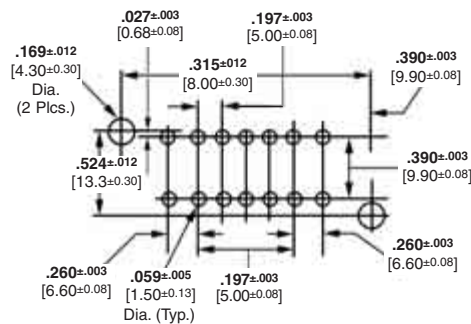

Recommended PC Board Layout

Note: All part numbers are RoHS compliant.

Standard Blind-Mate Drawer Connectors (Continued)

Housings for Crimp Snap-In Contacts

Material

Polybutylene terephthalate (PBT), blue, 94V-0 rated

Related Product Data

Performance Specifications — page 92

Crimp Snap-In Contacts — page 95

Panel Cutout — page 95

Technical Documents

Product Specification
108-5125

Application Specification
114-5044

Cable Mounted Products

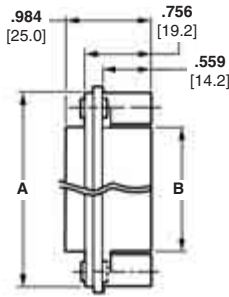

Receptacle

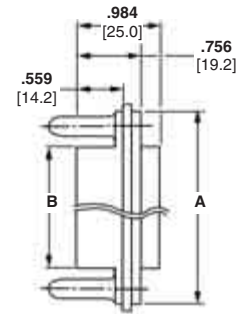
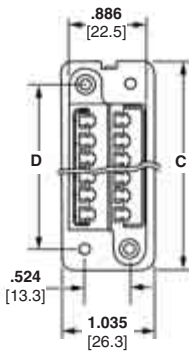

Plug

No. of Pos.	Dimensions						Receptacle		Plug	
	A	B	C	D	E	F	Floating Bushing Size	Part Numbers	Panel-Mount Hole Diameter	Part Numbers
8	1.858 47.20	1.055 26.80	2.016 51.20	1.500 38.00	1	.197 5.00	.118 3.00	5172070-1	.130 3.30	172063-1
							.157 4.00	5172070-3	.169 4.30	172063-3
12	2.252 57.20	1.449 36.80	2.410 61.20	1.890 48.00	3	.591 15.00	.118 3.00	5172069-1	.130 3.30	172061-1
							.157 4.00	5172069-3	.169 4.30	172061-3
16	2.657 67.20	1.843 46.80	2.803 71.20	2.283 58.00	5	.984 25.00	.118 3.00	5172068-1	.130 3.30	172059-1
							.157 4.00	5172068-3	.169 4.30	172059-3
20	3.039 77.20	2.236 56.80	3.197 81.20	2.677 68.00	7	1.378 35.00	.157 4.00	5173033-3	.169 4.30	173032-3
							.118 3.00	5172625-1	.130 3.30	172624-1
24	3.433 87.20	2.630 66.80	3.591 91.20	3.071 78.00	9	1.772 45.00	.157 4.00	5172625-3	.169 4.30	172624-3

Note: All part numbers are RoHS compliant.

Standard Blind-Mate Drawer Connectors (Continued)

Crimp Snap-In Contacts (Hermaphroditic)

Material and Finish

Phosphor bronze, plated gold in contact area (for length of .236 [6.0] from tip), with entire contact underplated nickel

Related Product Data

Performance Specifications — page 92

Housings — page 94

Technical Documents

Instruction Sheets

408-097J, 408-098J, 408-151J

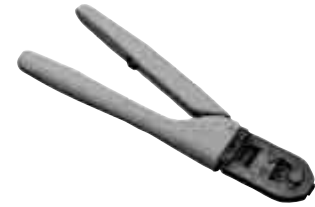
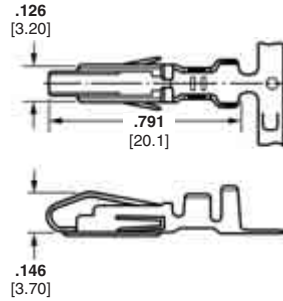

CERTI-CRIMP Hand Tool
Part Number 91591-1

Wire Size Range		Insulation Dia. Range	Part Numbers		Applicator for AMP-O-LECTRIC Machine*	Hand Tool Numbers
			Strip Form	Loose Piece		
24-20	0.2-0.6	.059-.077 1.50-1.95	170311-1	170313-1	567324-2	91591-1
20-16	0.5-1.4	.071-.130 1.80-3.30	170484-1	170485-1	567241-2	91590-1
18-14	0.8-2.0	.091-.154 2.30-3.90	170312-1	170314-1	567325-2	2063849-1

*Applicators are for Model "K" machines. Consult Tyco Electronics for applicators for other bench machines and lead-making machines.

Notes: 1. For applicable wire, use wire specified in UL 1015 or 1007.

2. Contacts for 18-14 AWG [0.8-2.0 mm²] wire are used at the four corners of the connector as power contacts (8 required per assembly).

Extraction Tool **Part Number 723986-1**

Recommended Panel Cutout

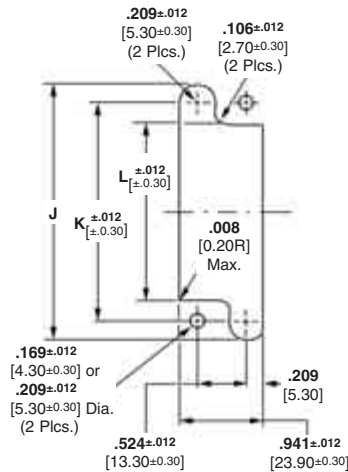

No. of Pos.	Rear Panel-Mount Dimensions		
	J	K	L
8	1.913 48.60	1.500 38.00	1.110 28.20
12	2.307 58.60	1.890 48.00	1.504 38.20
16	2.701 68.60	2.283 58.00	1.898 48.20
20	3.094 78.60	2.677 68.00	2.291 58.20
24	3.488 88.60	3.071 78.00	2.685 68.20

Rear Panel-Mount

Note: Mounting holes of .209 [5.30] dia. are used when mounting receptacle housings with .157 [4.0] long floating bushings and the mating plug housings. Panel thickness is .063 [1.60]. Panel cutout shown above is for use with plug housings. For receptacle housings, use the mirror-image cutout.

Note: All part numbers are RoHS compliant.

Hybrid Mini-Drawer Connectors

Product Facts

- Combine signal circuits and power circuits into one connector
- Power circuits can be used for high current of up to 15A
- Signal circuits accept CT connector in the back, reducing harnessing costs
- Power circuits use crimp-type tab and receptacle contacts
- Meet requirements for creepage distance and spatial distance for primary power supply as set forth in IEC-950, safety specifications for business machines and OA equipment.
Creepage distance on active power side: 5 mm
Spatial distance on active power side: 4.5 mm



Technical Documents

Product Specification
108-60022

Application Specification
114-5182

Hybrid mini-drawer connectors are designed for use in rack and panel application to serve as an I/O connector for copying machines, laser-beam printers and other OA equipment. They provide an economical means of combining into one connector signal circuits and power circuits which were packaged separately in the past.

A major design feature of these hybrid mini-drawer connectors is that mini-drawer connectors mate with one another on the connector mating side and in the back, signal circuits accept a pre-terminated CT receptacle connector.

Also, for power circuits, crimp-type power contacts are used by inserting them into the four corners of the mini-drawer connector.

The housing has an integrated guide-pin and socket to facilitate mating of the connector halves. Provision is also made to prevent dust from entering.

This product line includes:

- 12-position connector (4 positions for power and 8 positions for signal circuits)
- 24-position connector (4 positions for power and 20 positions for signal circuits)
- 32-position connector (4 positions for power and 28 positions for signal circuits)

Drawer connectors are available in the following types depending on application: (For details contact our sales department)

- Mini-drawer connectors
- Standard drawer connectors
- High current drawer connectors

Performance Data

Voltage Rating —
250V AC (power)
30V AC (signal)

Current Rating —
15A max. (power)
2A max. (signal)

Contact Resistance —
10 mm Ω max. (power)
40 mm Ω max. (signal)

Insulation Resistance —
100M Ω max.

Dielectric Withstanding Voltage —
1.8KV AC/min. (power)
1.0KV AC/min. (signal)

Durability — 3,000 cycles min.

Hybrid Mini-Drawer Connectors (Continued)

Standard Width

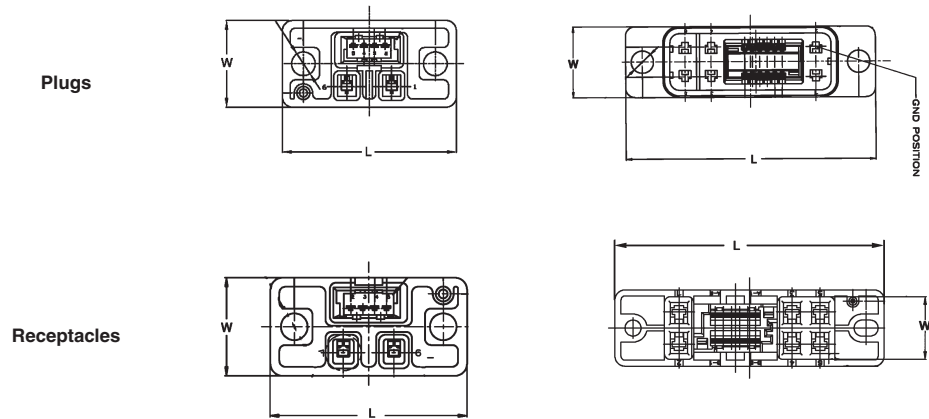

Type	Part Number	Number of Power Contacts	Number of Signal Contacts	L	W
Plug	292180-1	2	4	1.299 [33.00]	.646 [16.40]
Receptacle	292184-1	2	4	1.299 [33.00]	.646 [16.40]
Plug	1-292183-2	6	12	2.638 [67.00]	.748 [19.00]
Receptacle	1-292186-2	6	12	2.638 [67.00]	.748 [19.00]

Slim Width



Type	Part Number	Number of Power Contacts	Number of Signal Contacts	L	W
Plug	1-292187-2	3	5	1.870 [47.50]	.591 [15.00]
Receptacle	2-292190-2	3	5	1.713 [43.50]	.472 [12.00]
Plug	3-292187-2	4	5	2.146 [54.50]	.531 [13.50]
Receptacle	4-292190-2	4	5	1.988 [50.50]	.472 [12.00]
Plug	2-292189-3	3	7	2.028 [51.50]	.591 [15.00]
Receptacle	1-292192-3	3	7	1.870 [47.50]	.472 [12.00]

Note: All part numbers are RoHS compliant.

Hybrid Mini-Drawer Connectors (Continued)

Power Contacts

Material

Copper alloy
For finish, see table below.

Finish Codes

- 1) Over nickel underplated, contact area: gold plated, crimp area: tin plated
 - 2) Tin plated all over.
- Hand Tool AWG #20-24
Part No. 934199-1 (411-5662)
 AWG #16-20
Part No. 934198-1 (411-5661)

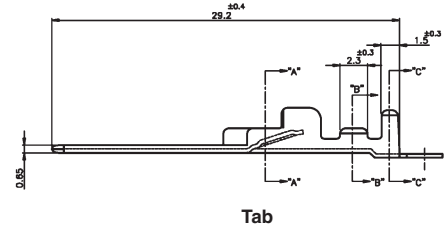
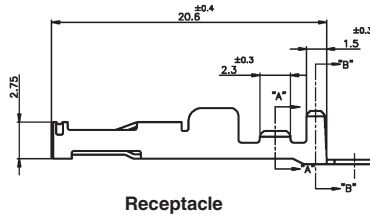
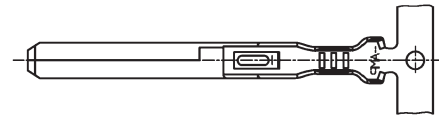
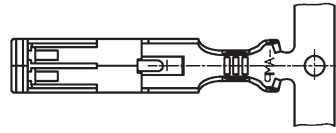

Wire Range AWG	Wire mm ²	Wire Ins. Dia.	Plating Code	Receptacle Part Number	Tab Part Number
				Strip Form	Strip Form
24-20	0.2-0.5	1.4-2.6	1	179317-2	179322-2
				1-179317-2	1-179322-2
20-16	0.5-1.25	1.6-2.8	1	179316-2	179321-2
				1-179316-2	1-179321-2

Receptacle Assembly

Material and Finish

Housing — Thermoplastic, black
Contact — Copper alloy, gold plated on mating side over nickel underplate, tin plated on CT mating side over nickel underplate.

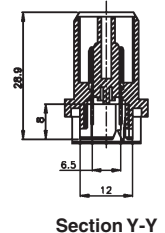
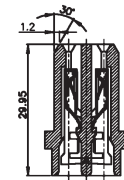
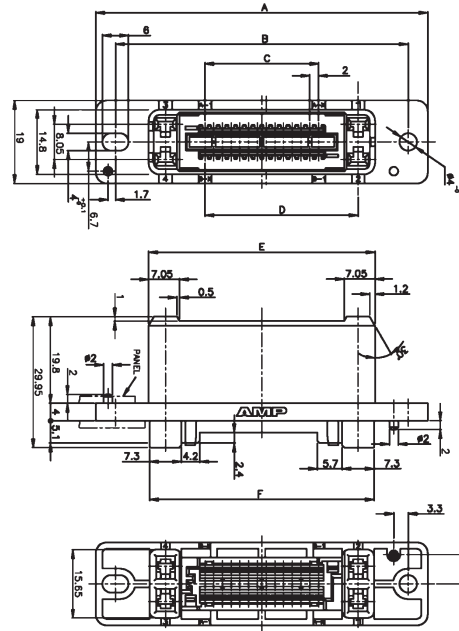

No. of Pos. (Power/ Signal)	Dimensions								Mini-Drawer Receptacle Assembly Part No.	Required Number of Power Contact	Required Number of CT Connector
	A	B	C	D	E	F	G	H			
12 (4-8)	56.0	47.0	6.0	24.1	31.8	31.4	38.0	32.4	292185-8	4	4 Pos. x 2
24 (4-20)	68.0	59.0	18.0	36.1	43.8	43.4	50.0	44.4	2-292185-0	4	10 Pos. x 2
32 (4-28)	76.0	67.0	26.0	44.1	51.8	51.4	58.0	52.4	2-292185-8	4	14 Pos. x 2

Note: All part numbers are RoHS compliant.

Hybrid Mini-Drawer Connectors (Continued)

Plug Assembly

Material and Finish

Housing — Thermoplastic, black UL94V-0

Contact — Copper alloy, gold plated on mating side over nickel underplate, tin plated platen on CT mating side over nickel underplate.



No. of Pos. (Power/ Signal)	Dimensions								Mini-Drawer Receptacle Assembly Part No.	Required Number of Power Contact	Required Number of CT Connector
	A	B	C	D	E	F	G	H			
12 (4-8)	56.0	47.0	6.0	24.1	36.0	31.4	33.4	38.0	292182-8	4	4 Pos. x 2
24 (4-20)	68.0	59.0	18.0	36.1	48.0	43.4	45.4	50.0	2-292181-0**	4	10 Pos. x 2
32 (4-28)	76.0	67.0	26.0	44.1	56.0	51.4	53.4	58.0	2-292181-8	4	14 Pos. x 2

*12-Position connector is provided with sequential feature in one power circuit position. Other connector sizes have sequential feature in power circuits and signal circuits.

**Optional part numbers offer sequential mating – see customer drawings for details.

Note: All part numbers are RoHS compliant.

Hybrid Mini-Drawer Connectors (Continued)

CT Receptacle Connectors to Mate with Signal Circuit Terminator with Insulation Displacement Contacts

Receptacle Assemblies (Wire Application Side)

Material and Finish

Housing — UL94V-0 rated, glass-filled P.B.T. see chart below for color.

Contact — Pre-tinned phosphor bronze

Wire Size — AWG #28-26 (0.08-0.15 mm²)

Insulation Dia. — 0.85-1.05 mm

Wire Size — AWG #24 (0.20-0.22 mm²)

Insulation Dia — 0.95-1.05 mm² (For AWG #24 wire, see notes under the table)

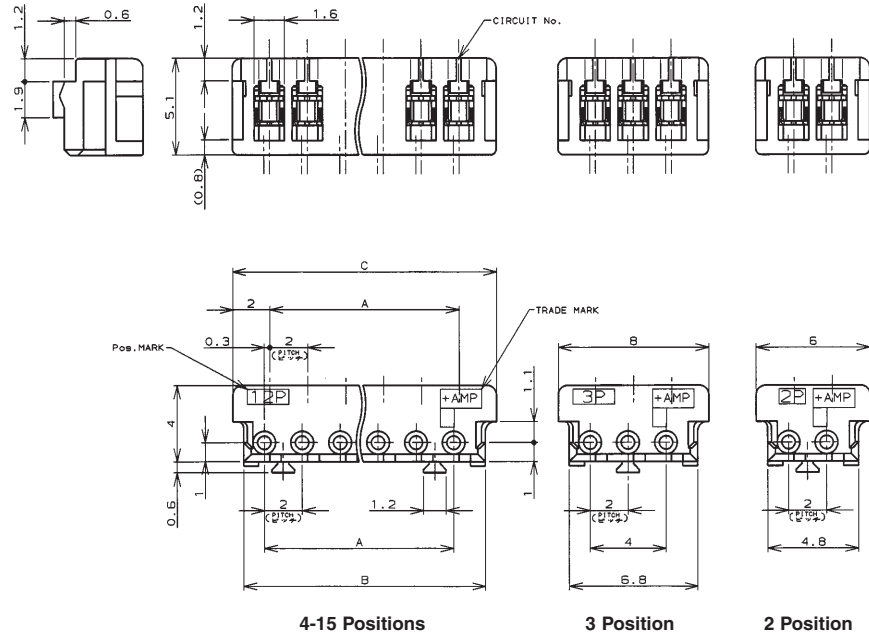

No. of Positions	Dimensions			Part Number	
	A	B	C	Receptacle Assembly**	
				AWG #28-26*	AWG #24***
2	2.0	4.8	6.0	173977-2	2-179694-2
3	4.0	6.8	8.0	173977-3	2-179694-3
4	6.0	8.8	10.0	173977-4	2-179694-4
5	8.0	10.8	12.0	173977-5	2-179694-5
6	10.0	12.8	14.0	173977-6	2-179694-6
7	12.0	14.8	16.0	173977-7	2-179694-7
8	14.0	16.8	18.0	173977-8	2-179694-8
9	16.0	18.8	20.0	173977-9	2-179694-9
10	18.0	20.8	22.0	1-173977-0	3-179694-0
11	20.0	22.8	24.0	1-173977-1	3-179694-1
12	22.0	24.8	26.0	1-173977-2	3-179694-2
13	24.0	26.8	28.0	1-173977-3	3-179694-3
14	26.0	28.8	30.0	1-173977-4	3-179694-4
15	28.0	30.8	32.0	1-173977-5	3-179694-5

* The color of housing is natural. Other colors available include blue, yellow and black. For details contact our Sales Department

** For wire to be used, contact our Sales Department as there are wires that have been tested by Tyco Electronics and can be recommended for your use.

*** The color of housing is gray.

Note: All part numbers are RoHS compliant.

Hybrid Mini-Drawer Connectors (Continued)

CT Receptacle Contacts to Mate with Signal Circuit Termination with Crimp Type Contacts

Receptacle Contact

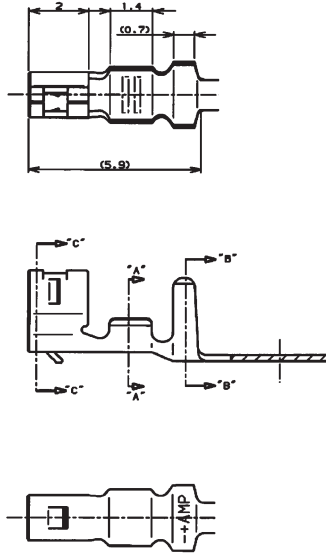

Wire Size AWG (mm ²)	Insulation Dia. (mm)	Material and Finish	Part Number		
			Strip Form	Loose Piece	Hand Tool
30-26 (0.05-0.12)	0.65-1.35	Phosphor bronze (0.20 mm thickness), tin plated	179609-1	—	234169-1 (411-5711)
26-22 (0.12-0.35)	0.93-1.5		179227-1	179518-1	91572-1 (408-8547)

Note: Loose piece contacts, being small in size, are supplied in the form of a comb with 10 pieces on 7.5 mm pitch. There is a slit at the root of each contact and it can be snapped off easily.

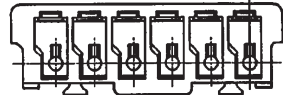
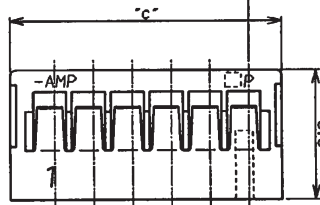
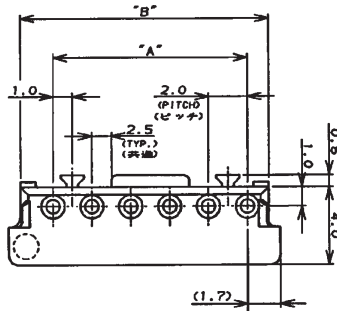

4-15 Positions

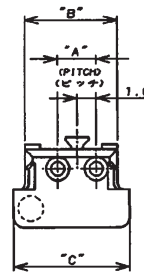

2 Position

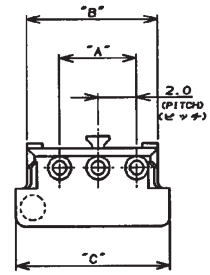

3 Position

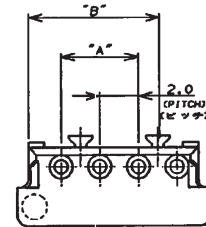

4 Position

Receptacle Housing Material

UL94-0 rated, 66 nylon, natural color (white)

No. of Positions	Dimensions			Part Number Receptacle Assembly*
	A	B	C	
2	2.0	4.8	6.0	179228-2
3	4.0	6.8	8.0	179228-3
4	6.0	8.8	10.0	179228-4
5	8.0	10.8	12.0	179228-5
6	10.0	12.8	14.0	179228-6
7	12.0	14.8	16.0	179228-7
8	14.0	16.8	18.0	179228-8
9	16.0	18.8	20.0	179228-9
10	18.0	20.8	22.0	1-179228-0
11	20.0	22.8	24.0	1-179228-1
12	22.0	24.8	26.0	1-179228-2
13	24.0	26.8	28.0	1-179228-3
14	26.0	28.8	30.0	1-179228-4
15	28.0	30.8	32.0	1-179228-5

* The color of housing is natural. Other colors available include blue, yellow and black. For details contact our Sales Department

Note: All part numbers are RoHS compliant.

ET Power Connector

Product Facts

- Right-angle and vertical mounts available
- Low profile right-angle connector ≤ 8 mm above pcb
- 2.5 mm² (14 AWG) to 6 mm² (10 AWG) wire range
- Refer to current v temp rise graphs for current capability
- Coding contacts for sense function
- Positive metal latch retention
- Up to 30 Amps per contact. See temperature rise charts on page 103



Description

- Cable to pcb
- Low profile Right Angle
- Vertical Mount
- High reliability interface
- Excellent price to performance ratio

Designed for low-profile power distribution units requiring small form factor connector with high current, the ET power connector is a low loss, highly reliable and cost effective solution for cable-to-pcb applications.

The connector is available in both a vertical mount and a right-angle mount, which stands at just 8 mm off of the board. A unique feature of the ET power series is integrated coding contacts which allow different electronic functions such as sense and enable to be

designed into the PDU electronics with activation on full insertion of the cable connector.

Crimp contacts from the industry proven "Standard Power Timer" range for use with 2.5 mm² (14 AWG), 4 mm² (12 AWG) and 6 mm² (10 AWG) wire.

The cable connector has a positive latching mechanism providing no accidental un-mating even with pull forces up to 100N.

Material and Finish

Housing ST Cable — Black glass-filled thermoplastic, UL 94V-0 rated

Latch — Stainless Steel

Housing ST & Right-angle PCB — Black glass-filled thermoplastic, UL 94V-0 rated

Power Contacts — Copper alloy, 3.0 μ m Ag min.

Contact Detection — 0.8 μ m gold min. in contact place; 1.27 μ m nickel min. contact place

Application

- Power Distribution
- Power Supplies
- Telecoms Base Stations
- Computer Servers and Storage Systems
- Industrial Electronic Equipment Cabinets

Technical Documents

Product Specification

108-19346

Application Specification

114-19110

Test Results

Temperature Rise vs. Current Results

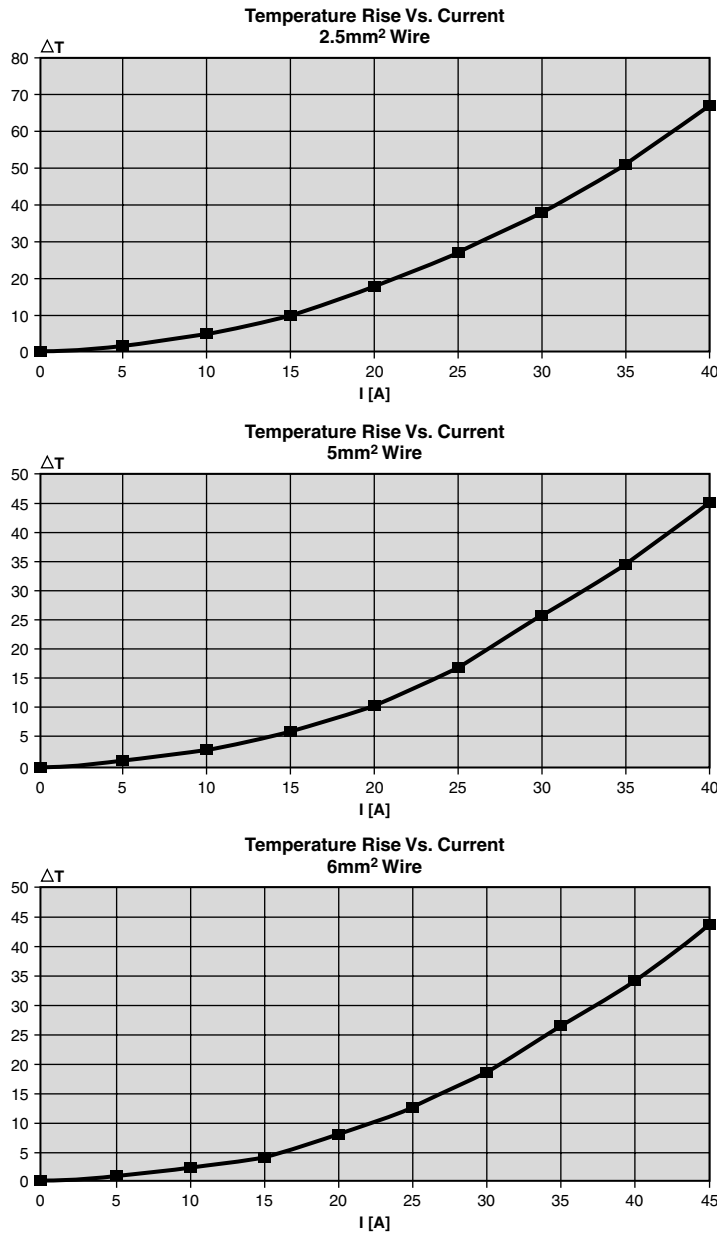

Contact Summary

Refer to Standard Timer catalog 889759 for detailed information or Product/ Application Specification.

Wire Size Range mm ²	Part Number
0.2 – 0.5	927840-4
0.5 – 1.0	927831-4
>1.0 – 2.5	927837-4
>2.5 – 4.0	927829-5
>4.0 – 6.0	963709-5

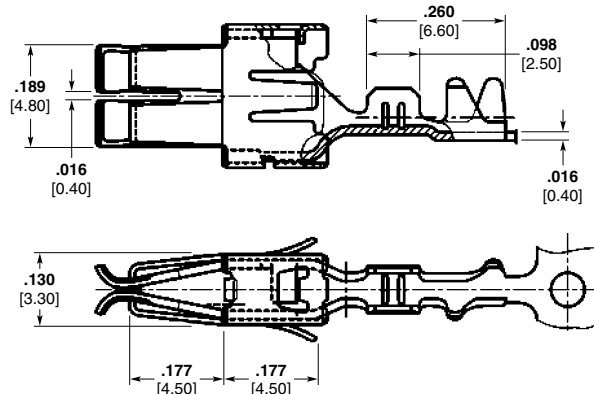

Material Plating — Silver

- Technical Documents**
- Product Specification** 108-18025
 - Application Specification** 114-18037

Note: All part numbers are RoHS compliant.

ET Power Connector (Continued)

ET Power Cable Connector

Material and Finish

Housing — Thermoplastic,
UL 94V-0 rated

Latch — Stainless Steel



Part Number 1982299-1
With Right Coding Key Only

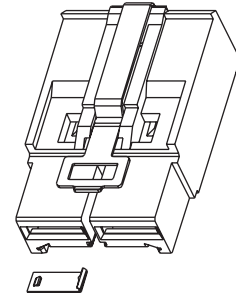

Part Number 1982299-2
With Left Coding Key Only

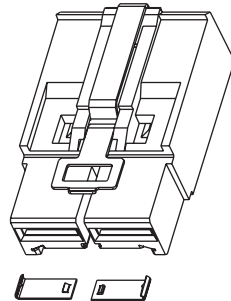

Part Number 1982299-3
With Two Coding Keys

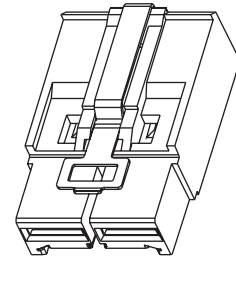

Part Number 1982299-4
Without Coding Keys

Right-Angle PCB Header

Material and Finish

Housing — High temperature liquid
crystal polymer, UL 94V-0 rated

Contacts — Silver plated copper alloy

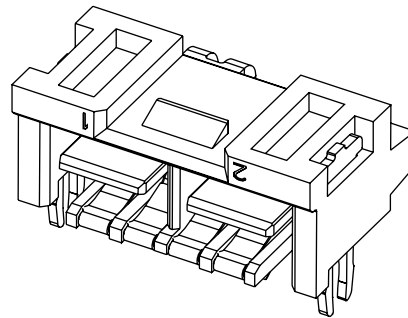

Part Number 1982295-1
With Coding Contacts

Part Number 1982295-2
Without Coding Contacts

Vertical PCB Header

Material and Finish

Housing — High temperature liquid
crystal polymer, UL 94V-0 rated

Contacts — Silver plated copper alloy

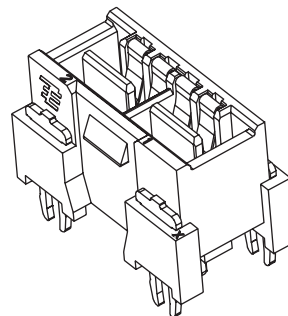

Part Number 2042274-1
With Coding Contacts

Part Number 2042274-2
Without Coding Contacts

Note: All part numbers are RoHS
compliant.

AMP-DUAC PL Connectors

Product Facts

- Wire to board connection system
- Improved dual-action contact design — provides better contact lead-in and reduces contact mating force
- Sequenced contacts available for mate-first break-last operation
- 4-, 6- and 12-position right-angle headers and free hanging receptacles
- 4.2 mm x 5.5 mm centerline
- Receptacle contacts designed for 26-16 AWG stranded wire
- Recognized under the Component Program of Underwriters Laboratories Inc.,  File No. E28476
- Certified by Canadian Standards Association,  File No. LR7189

Technical Documents

Product Specification
108-1646

Application Specification
114-6067-Crimping Contacts

Qualification Test Report
501-394

Performance Data

Voltage Rating — 600 VAC

Current Rating — 9 Amps maximum
in 2-position application

Low Level Resistance —
10 megohms max.

Dielectric Withstanding Voltage —
1500 VAC/min.

Insulation Resistance —
1000 Megohms minimum

Operating Temperature —
-55°C to + 105°C [-67°F to +221°F]



The latest addition to the 4.2 mm Wire-to-Board Power Connectors is the AMP-DUAC PL Connector. This product uses the industry proven AMP-DUAC contacts with the addition of several housing improvements to offer significant overall improvements in connector reliability. The product is available in both component form and as fully assembled custom cable assemblies.

The AMP-DUAC PL housings are designed to confirm that all electrical contacts are fully seated. The “PL” refers to “Positive

Locking” of the contacts. It is also referred to as terminal position assurance. Contacts are inserted into the receptacle housing and the contact lock is installed to lock all the contacts into position. If any one of the contacts is not fully inserted, the contact lock cannot be installed. This feature eliminates a common concern of operator fatigue and the resulting contact back-out, which occurs when a contact is not installed properly. An improved mounting flange has also been added for more secure printed circuit board mounting.

Finally, the housings have been re-designed to provide an improved latch, which offers a metal spring instead of the original plastic spring/latch. An extended latch arm is also available for hard to reach installations or where the connectors are stacked in close proximity.

All the housings are polarized to help prevent mis-mating.

AMP-DUAC PL Connectors (Continued)

**AMP-DUAC PL
PCB Headers**

Material

Housings — Nylon, UL 94V-0
Color, white

Contacts — Brass, tin-lead

Finish — 0.00038 [0.00030] gold in mating area, tin-lead in solder tail, all over 0.00127 [0.000050] nickel



**Recommended Mounting Hole Pattern
For 1.78 Max. Thick PC Board
Component Side Shown**

No. of Positions	Mate-First Break-Last Position #	Part Number
4	All Standard Length 3	5794172-2 5794172-3
6	All Standard Length 3	5794173-2 5794173-3
12	All Standard Length 4	5794176-2 5794176-3

Note: All part numbers are RoHS compliant.

AMP-DUAC PL Connectors (Continued)

AMP-DUAC PL Receptacles

Material

Housings — Nylon, UL94V-0
Color, White

Technical Documents — page 105

Contacts — page 113

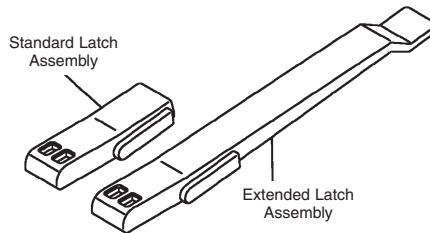
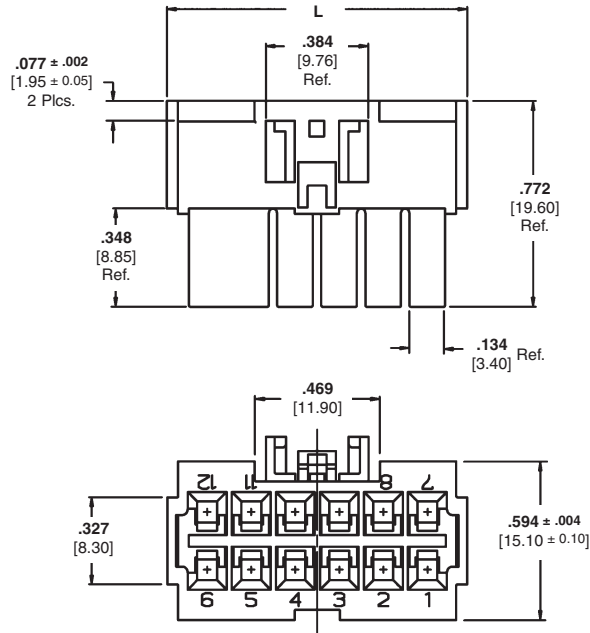
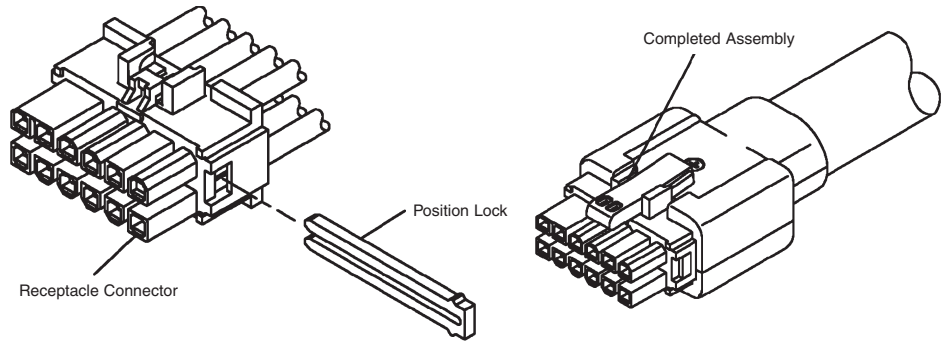

No. of Positions	Dimension L	Part Numbers			
		Housing	Housing with Positive Lock	Standard Latch	Extended Latch
4	15.9	794152-1*	794318-1		
6	20.1	794153-1	794319-1	794150	794149
12	28.6	794156-1	794322-1		

*Latch items ordered separately
Optional keying plug — Part No. 794144-1

Note: Position Lock Required — use one per housing — Part No. 794145-3

Note: All part numbers are RoHS compliant.

AMP-DUAC PL-II Connectors

Product Facts

- Wire-to-board connection system combining power and signal contacts
 - 10A power contacts
 - 4A signal contacts
- High conductivity copper alloy power contacts yield 30% gain in current carrying capacity compared to alternative designs
- Dual action contact design — reduces mating forces by up to 50% compared to alternative designs
- 9 power and 20 signal contacts
- Positive Lock (PL) feature on both power and signal contacts ensures contacts remain in position in cable receptacle
- Pin and receptacle contacts offered in three sizes:
 - 16 AWG
 - 18 AWG
 - 20-22 AWG
- Wide 5.2 X 5.5 mm contact spacing allows for 300V applications.
- Recognized under the Component Program of Underwriters Laboratories Inc., File No. E28476



The AMP-DUAC PL-II Connectors bring both shielding and a power / signal mix to the popular AMP-DUAC product family. In addition, the wider contact spacing and the use of high conductivity materials results in a higher current carrying capacity than the original 4.2 mm pitch AMP-DUAC product.

The deep back shell allows for gathering the larger wire and insulation diameters involved with combination power / signal and shielding all in the same cable. Traditional signal connectors do not accept the range of wire sizes covered by the AMP-DUAC PL-II product.

For applications involving higher voltage cabled power distribution, this product is the ideal solution. The AMP-DUAC PL-II connector uses the original industry proven dual-action contact design which provides a lower mating force and less plating wear than alternate contact designs. The signal contacts also feature a twin-cantilever beam that mates on the milled contact surface to provide low plating wear and high long-term reliability.

The cable mounted receptacle uses the popular “Positive Lock” devices proven throughout the automotive industry to ensure all the contacts are fully seated. The “positive locks” are also referred to as “terminal position assurance”. If any one of the contacts is not properly / completely installed into the housing, then the “Positive Lock” can not be installed. This feature reduces the common concern of operator fatigue and the resulting contact back-out which occurs when a contact is not properly seated.

The shielding system fully encapsulates the inner conductors and cable braids and provides a reliable conduction to the faceplate of the mating equipment.

Finally, the cable retention is accomplished through two rear-accessed over molded jackscrews for easy installation and removal.

Technical Documents

Product Specification
108-2218

Application Specification
Contact Tyco Electronics

Performance Data

Voltage Rating — 600 VAC

Current Rating —
10 Amps max on a single contact
6 Amps on each contact in 48 pos.
connector

Low Level Resistance —
10 milliohms max

Insulation Resistance —
1000 Megohms minimum

Operating Temperature —
-40°C to +105°C

Materials

Housing Material — PBT, UL 94V-0

Colors —
Plugs and Receptacles — Black
Positive Locks — White

AMP-DUAC PL-II Connectors (Continued)

PCB Plug
Part Number 6469602-3

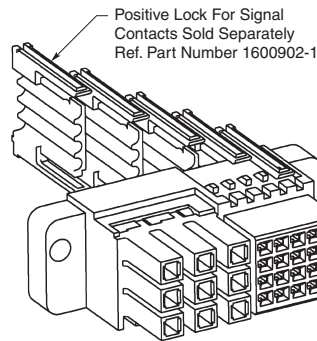

Free-Hanging Receptacle
Shown with Positive Locks
Part Number 1469606-1

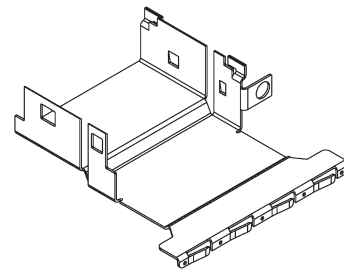

Shield
Part Number 1469609-2

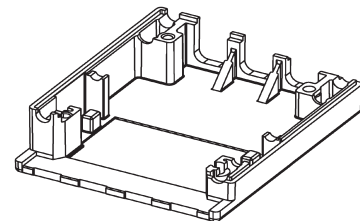

Cable Clamp
Part Number 1469610-1

Note: Other cable components required. Cable receptacle components shown not sold separately. Receptacle only sold as part of a finished cable assembly.

Note: All part numbers are RoHS compliant.

AMP-DUAC UPC Connectors

Product Facts

- Wire-to-wire connection system
- High conductivity copper alloy contacts yield 30% gain in current carrying capacity compared to alternative designs
- Dual action contact design — reduces mating forces by up to 50% compared to alternative designs
- Sequenced contacts for make-first-break-last operation
- 48 and 66 position housings
- 4.4 mm X 5.3 mm contact grid
- Pin and Receptacle contacts offered in three sizes:
 - 16 AWG
 - 18 AWG
 - 20-22 AWG
- Recognized under the Component Program of Underwriters Laboratories Inc., File No. E28476

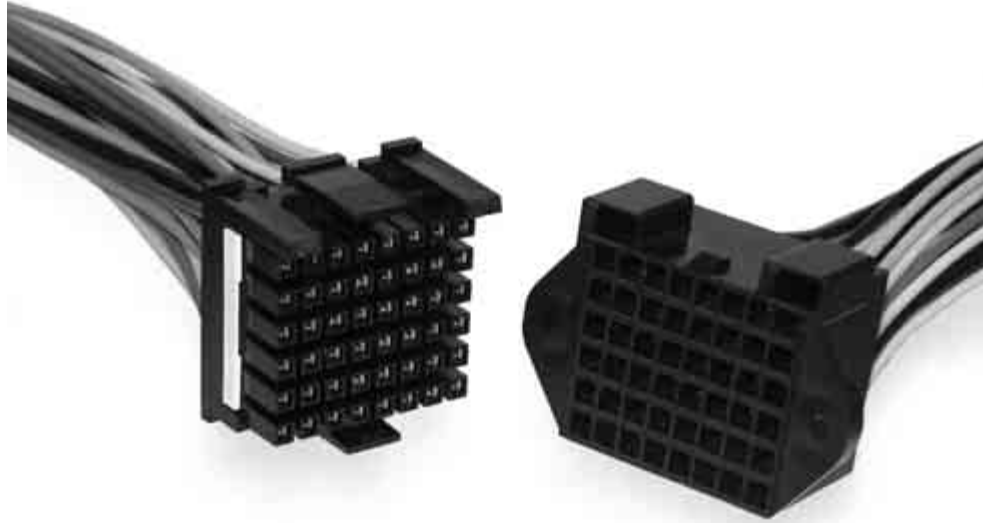

The latest addition to the AMP-DUAC product family is the AMP-DUAC UPC connector. The UPC connector offers much higher pin counts and a variety of product improvements to make the connector more reliable and easier to use. The UPC connector uses the original industry proven dual-action contact design along with very high conductivity copper alloys to improve the current carrying capacity.

The first noticeable difference of the UPC connector is the large pin count. With either 48 or 66 positions, the housing can serve as a common mating I/O point where multiple low current power connector cables are combined into one interface. Other connectors would yield an excessive mating force when mating this number of wires, however, the low mating force of the AMP-DUAC / UPC connector allows up to 66 wires to be mated with less than a 20 lb mating force.

The next key improvement is the use of molded-in guide pins. The guide pins make the mating process very easy and provide a visual polarization of the connector. The housings mate together easily.

The use of two locking latches provides a more secure connection and the screw-mounts for the panel mounted plug provide better retention than plastic latches.

Finally, the free-hanging receptacle uses the popular “Positive Lock” device to confirm all the contacts are fully seated. The “positive locks” are also referred to as “terminal position assurance”. If any one of the contacts is not properly/ completely installed into the housing, then the “Positive Lock” can not be installed. This feature eliminates the common concern of operator fatigue and the resulting contact back-out which occurs when a contact is not properly seated.

Technical Documents

Product Specification

108-2248

Application Specification

114-13195

Performance Data

Voltage Rating — 600 VAC

Current Rating —

11 Amps max on a single contact
4 Amps on each contact in 48 pos. connector

Low Level Resistance —
10 milliohms max

Insulation Resistance —
1.2 E16 ohms minimum

Operating Temperature —
-40°C to +105°C

Materials

Housing Material — PBT, UL 94V-0

Colors —

Plugs and Receptacles — Black
Positive Locks — White

AMP-DUAC UPC Connectors (Continued)



Panel-Mount Plug
(Accepts contacts on page 112)



Free-Hanging Receptacle
(Accepts contacts on page 113)

Size (No. Circuits)	Panel-Mount Plug	Dimensions			Free-Hanging Receptacle*	Positive Lock*
		A	B	C		
48	1934142-1	1.61 41.0	1.85 47.0	2.22 56.4	1934144-1	1469910-1
66	1934143-1	2.13 54.2	2.37 60.2	2.74 69.6	1934145-1	1934017-1

*Two (2) required for each receptacle housing. Not used in plug housings.
Additional configurations possible. For information, please contact your Tyco Electronics sales engineer.

Note: All part numbers are RoHS compliant.

Contacts for AMP-DUAC PL, PL-II and UPC Connectors

Materials — High Conductivity Copper Alloy
Finish — Pre-Tin or Gold Plated



Cable Mounted Products

Contacts, Male

Technical Documents

Product Specification
108-2248 AMP-DUAC UPC

Application Specification
114-6067 AMP-DUAC PL
114-13195 AMP-DUAC UPC

AMP-DUAC PL or UPC Contacts

Wire Size Range AWG [mm ²]	Ins. Dia. Range	Plating	Part Number (Continuous Strip)	Applicator
22-20 [0.3-0.5]	.590-.094 [1.50-2.40]	Gold	794576-4	680308-3
18 or 18+22 [0.8-1.1]	.087-.154 [2.20-3.90]	Gold	1934185-4	1852467-3
16 or 2 @ 18 [1.3-1.6]	.098-.173 [2.50-4.40]	Gold	1934184-4	1852468-3

Application Equipment: Extraction Tool 1976132
*Made from Phosphor-Bronze material (low conductivity)

Note: All part numbers are RoHS compliant.

Contacts for AMP-DUAC PL, PL-II and UPC Connectors (Continued)

Materials — High Conductivity
Copper Alloy
Finish — Gold Plated



Contacts, Female

Technical Documents

Product Specification

108-2248 AMP-DUAC UPC

Application Specification

114-6067 AMP-DUAC PL

114-13195 AMP-DUAC UPC

AMP-DUAC PL or UPC Contacts

Wire Size Range AWG [mm ²]	Ins. Dia. Range	Plating	Part Number (Continuous Strip)	Applicator
22-20 [0.3-0.5]	.590-.094 [1.50-2.40]	Gold	1934193-4	1852469-3
18 or 18+22 [0.8-1.1]	.087-.154 [2.20-3.90]	Gold	1934183-4	1852467-3
16 or 2 @ 18 [1.3-1.6]	.098-.173 [2.50-4.40]	Gold	1934182-4	1852468-3

Application Equipment: Extraction Tool 1976382

Note: All part numbers are RoHS compliant.

Other Soft Shell Pin & Socket Connectors

Micro MATE-N-LOK 3 mm Connector System

- Wire-to-wire and wire-to-board, pin and receptacle connectors
- 3.0 mm [.118] centerline spacing
- 2-12 positions – single row
- 2-24 positions – dual row
- Ratings: 5A, 250 VAC
- Accommodates 30-20 AWG wire
- Panel-mount or free-hanging versions
- Dual beam receptacle contact design for improved reliability
- PCB-mount pin header assemblies available in both vertical and right-angle styles; surface-mount or through hole versions
- Available in a low profile design (<4.7 mm)



Grace Inertia Connector System

- Wire-to-wire and wire-to-board, blade and receptacle connectors
- Wire-to-wire
 - 2.5 mm, 3.5 mm and 6.2 mm centerline spacing
 - Select 2-12 position depending on centerline spacing
- Wire-to board
 - 2.0 mm, 3.3 mm, 6.5 mm, 7.92 mm, 9.0 mm and 12.4 mm centerline spacing
 - Select 2-20 position depending on centerline spacing
- Four kinds of keying per color-coded housings
- Inertia locking mechanism on the housing which simultaneously locks when mated to prevent mismatching
- Robust connections for use in high vibration or transportation applications



Commercial Pin and Socket Connector System

- Panel-mount or free-hanging, wire-to-wire, pin and socket connectors
- 3.68 mm [.145"] and 5.03 mm [.198"] centerline spacing
- High density, 1-9 positions – 2, 3 & 4 in-line and 4, 6 & 9 matrix
- Standard density, 1-15 positions – 2-6 in-line and 4, 6, 9, 12 & 15 matrix
- Ratings: 7A (high density) or 13A, 250 VAC
- High density system accommodates 30-18 AWG wire
- Standard density system accommodates 24-14 AWG wire
- Dual contact locking lances provide optimum contact stability
- Low contact-mating force



For more Information Order Catalog 82181, "Soft Shell Pin and Socket Connectors"

Other Soft Shell Pin & Socket Connectors (Continued)

Power Double Lock Connector System

- Wire-to-wire and wire-to-board, blade and receptacle connectors
- 3.96 mm [.156] and 6.5 mm [.256] centerline spacing
- High density, 1-12 positions – 2, 3 & 4 in-line and 4, 6, 8, 9, 10 & 12 matrix
- Standard density, 2-12 positions – 2, 3 & 4 in-line and 4, 6, & 12 matrix
- Ratings: 14A, 300 VAC
- Accommodates 26-16 AWG wire
- Panel-mount or free-hanging versions
- Optional double lock plate on the wire side that confirms contact seating
- Lanceless contacts prevent entanglement of contacts with each other
- Housings are polarized with four types of special keying to prevent mismatching

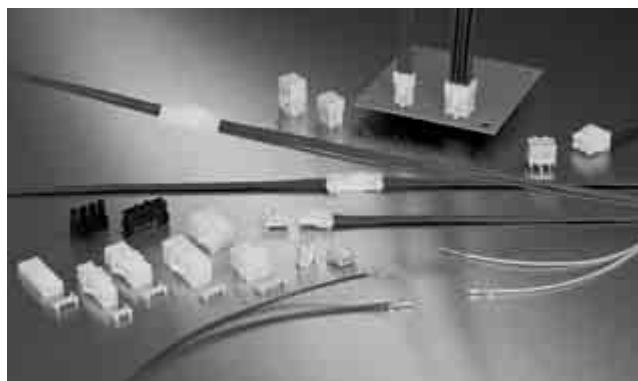

Mini-Universal MATE-N-LOK and Mini-Universal MATE-N-LOK II Connector System

- Wire-to-wire and wire-to-board, pin and socket connectors
- 4.14 mm [.163"] centerline
- 1-24 and 2-24 positions, respectively
- Ratings: 9.5A and 10.5A respectively
600 VAC or VDC
- Accommodates 30-16 AWG wire
- Compact, durable housings
- Contacts protected in the housings
- Fully polarized to provide proper mating
- Seals available for splash protection (Mini-Universal MATE-N-LOK system only)

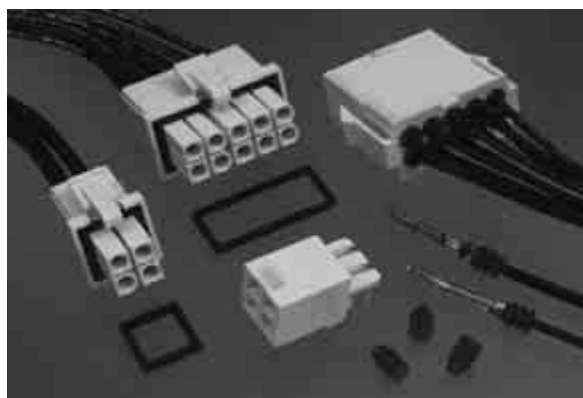

VAL-U-LOK Connector System

- Wire-to-wire and wire-to-board, pin and receptacle connectors
- 4.2 mm [.165] centerline
- 2-24 position dual row and 3-5 single row configurations
- Ratings: 9A, 600 VAC
- Accommodates 26-18 AWG wire
- Easy-to-mate, positive locking housings
- Fully isolated terminals
- Panel-mount or free-hanging versions
- Black, red and blue in addition to the standard white
- PCB headers are available in vertical, right-angle, screw-mount, and blind-mate configurations
- Intermateable with similar connectors from other manufacturers



For more Information Order Catalog 82181, "Soft Shell Pin and Socket Connectors"

Other Soft Shell Pin & Socket Connectors (Continued)

Commercial MATE-N-LOK Connector System

- Wire-to-wire and wire-to-board, pin and socket connectors
- 5.08 mm [.200"] centerline
- Panel-mount or free-hanging versions
- 1-16 positions
- Ratings: 19A, 250 VAC
- Accommodates 30-14 AWG wire
- Fully polarized housings
- Contact stabilization and self-aligning features
- Hot side is egg-crated for safety
- Locking devices are integral part of design



Universal MATE-N-LOK and Universal MATE-N-LOK II Connector System

- Wire-to-wire and wire-to-board, pin and socket connectors
- 6.35 mm [.250"] centerline
- 1-15 and 2-15 positions, respectively
- Panel-mount or free-hanging versions
- Ratings: 19A, 600 VAC or VDC
- Accommodates 30-10 AWG wire
- Contacts protected in the housings
- Special keying to prevent incorrect mating
- Additional offerings include:
 - UV resistant materials
 - High temperature materials
 - Glow wire approved products
 - Special high retention contacts
 - Seals available for splash protection (UMNL only)
 - Color housings available (UMNL only)



For more Information Order Catalog 82181, "Soft Shell Pin and Socket Connectors"

AMPINNERGY Wire-To-Wire Connectors

Product Facts

- Rated to 600 VAC (RMS)
- Flame retardant housings 94V-0
- Housings, adapters, and power terminals keyed for proper assembly
- Stackable housings provide easy wire routing and neat wire dressing
- Built-in interlocking features better resist shock and vibration
- Usable as in-line connector, or as panel and surface-mount connector
- Available in six different colors for circuit coding and identification
- Choice of two power terminals accommodates 10-12 AWG and 14-16-18 AWG conductors
- Recognized under the Component Program of Underwriters Laboratories Inc., File No. E28476 
- Certified by Canadian Standards Association, File No. LR7189 
- VDE Registered #5133



AMPINNERGY wire-to-wire (WTW) Connectors provide a reliable and efficient means of interconnecting conductors employed to carry up to 600 VAC in power circuits or networks.

The WTW connectors consist of mating hermaphroditic, flame retardant polycarbonate housings into which customer terminated power contacts are inserted. Stackable in four directions through the use of molded interlocking keyways, the connectors make wire routing and dressing orderly and easy to accomplish. More importantly, the built-in interlocking features on the connectors and the accessory mounting adapters provide better resistance to the effects of shock and vibration, keeping the interconnect more stable and secure.

The design features of the WTW connector make it easily applicable to free-hanging, surface mounted or panel mounted applications. By simply sliding the accessory mounting adapters into the molded keyways of the connector housing, a free-hanging connector can be trans-

formed into a surface-mount connector or a panel-mount connector. Customer supplied 8-32 screws and nuts may be used to secure the connectors configured with the mounting adapters to printed circuit boards or distribution panels. The same hardware may be used to secure the connectors to pre-cut openings in the panels.

Furthermore, WTW connector housings, mounting adapters and power terminals are all provided with alignment or keying features that make it difficult to improperly assemble and apply the connector. Alignment slots and tabs on the plastic connector housings provide for easy mating of the housings, even in the dark! Mounting adapters have a keyway on one side and a key on the other side providing for easy assembly to the connector by touch alone if necessary. And the power terminals have a side tab that helps prevent the incorrect insertion of the terminated conductor into the housing. Once inserted, the contacts

firmly latch within the connector housing.

The WTW connector system is available in six different and distinctive colors which makes circuit differentiation and identification possible. The crimped power terminals will accommodate either 10-12 AWG or 14-16-18 AWG stranded conductors. Depending upon the conductor size and the number of conductors in the connector configuration, the current rating ranges from 10 Amps to 55 Amps.

Technical Documents

Product Specification
108-1373 AMPINNERGY WTW Connectors

Application Specification
114-6051

Instruction Sheets
408-3277 AMPINNERGY Wire-To-Wire Stackable Connectors
408-3198 Inspection of AMPINNERGY System Power Contacts

For more information, request Catalog 1308885.

AMPINNERGY Wire-To-Wire Connectors (Continued)

Housings

Material and Finish

Housing — Polycarbonate, 94V-0

For surface mounting and panel mounting information, see Instruction Sheet 408-3277, AMPINNERGY Wire-To-Wire Stackable Connectors.

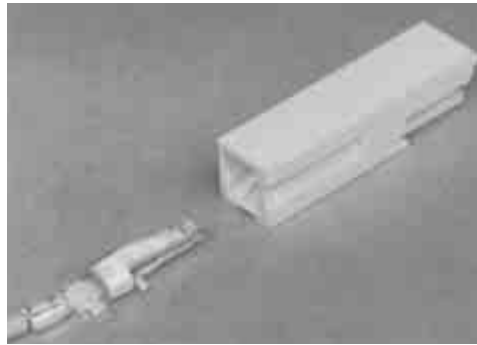

Customer terminated power contacts are inserted into housings



Free-Hanging Interconnections

Color	Housing Part Numbers
White	556137-1
Black	556137-2
Green	556137-3
Red	556137-4
Blue	556137-6
Gray	556137-8

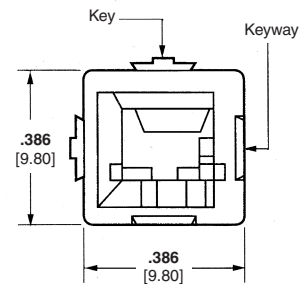
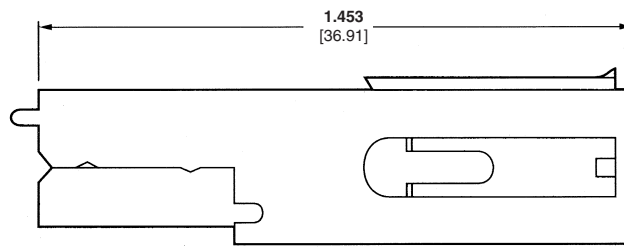

Wire-To-Wire Connector Housing

Mounting Adapters

Part Number 557313-1

Material and Finish

Housing — Polycarbonate, Black

Two mounting adapters can be used with one or more connector housings to provide thru-panel or horizontal surface mounting capability of the completed assembly.

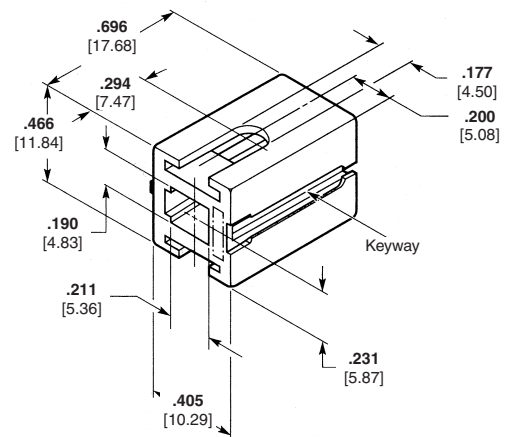

External Locking Latch Clip

Part Number 557640-1

AMPINNERGY wire-to-wire connector housings have an integral locking feature designed to keep housings mated in most applications. However, the external locking latch clip may be used as needed in applications where severe vibration or tension may pull mated housings apart.

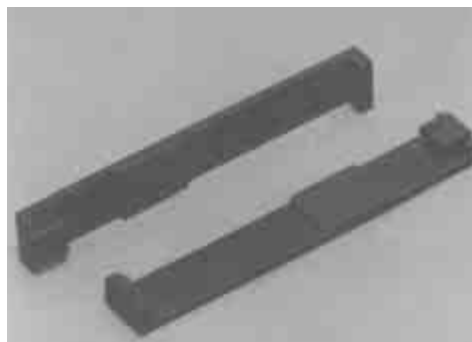

AMPINNERGY Wire-To-Wire Clips
Part Number 557640-1



AMPINNERGY Wire-To-Wire Clips (Installed)
Part Number 557640-1

Note: All part numbers are RoHS compliant.

AMPINNERGY Wire-To-Wire Connectors (Continued)

Power Terminals

Material and Finish

Contacts — Copper alloy plated with .000100 [0.00254] minimum tin

The wire-to-wire connector power contacts are available in either strip form or in loose piece form.

Contacts in strip form are terminated on continuous feed type terminators and the loose piece contacts are terminated with the hand tool or pneumatic tool.

For wire preparation and crimped contact inspection information, refer to Instruction Sheet 408-3198, Inspection of AMPINNERGY System Power Contacts.

Loose Piece

Part Number 556136-2

Part Number 556135-2



Contact Part Numbers	Wire Size (AWG)	Hand Tool Part Number	Pneumatic Tool Part Numbers	Die Set Part Numbers
556135-2 (loose piece)	18-16	69710-1	189721-2*	58493-1
	14			58492-1
556136-2 (loose piece)	12			58490-1
	10			58491-1

*Requires "C" head adapter part number 318161-1 and adapter holder part number 189928-1. See Catalog 124208 for more information.

Note: The same hand tool or pneumatic tool and die sets may be used to apply the wire-to-board connector terminals.

Strip Form



Contact Part Numbers	Wire Size (AWG)	AMP-O-LECTRIC Model G Terminating Machine	Applicator Part Numbers
556135-1 (strip)	18-16-14	354500-1	567403-3
556136-1 (strip)	10-12	354500-1	567256-6
788109-1 (strip)	18-14	354500-1	680447-3
788110-1 (strip)	10-12	354500-1	680449-3

Note: All part numbers are RoHS compliant.

AMPINNERGY Wire-To-Board Connectors

Product Facts

- **Ratings: 600 VAC (RMS), current ratings range from 12-35 Amps**
- **Receptacles polarized to plug**
- **Receptacles and plugs available in contact configurations of 2 through 8 positions**
- **Vertical receptacle polarized to PCB**
- **Receptacle contacts have dual solder posts for efficient heat dissipation, low millivolt drop and mechanical strength**
- **Receptacles may be mounted on PCBs .062 to .125 inch thick**
- **Plugs have positive latching to receptacles**
- **Removable crimp contacts latch firmly in plug**
- **Plugs are one-piece design**
- **Two ranges of crimped contacts accommodate either 10-12 AWG or 14-16-18 AWG conductors**
- **Recognized under the Component Program of Underwriters Laboratories Inc., File No. E28476**
- **Certified by Canadian Standards Association, File No. LR7189-239**



Technical Documents

Product Specification
108-1349 AMPINNERGY WTB Connectors

Application Specification
114-6044 AMPINNERGY WTB Connectors

Instruction Sheets
408-3236 Installation of AMPINNERGY WTB Connectors
408-3198 Inspection of AMPINNERGY Contacts

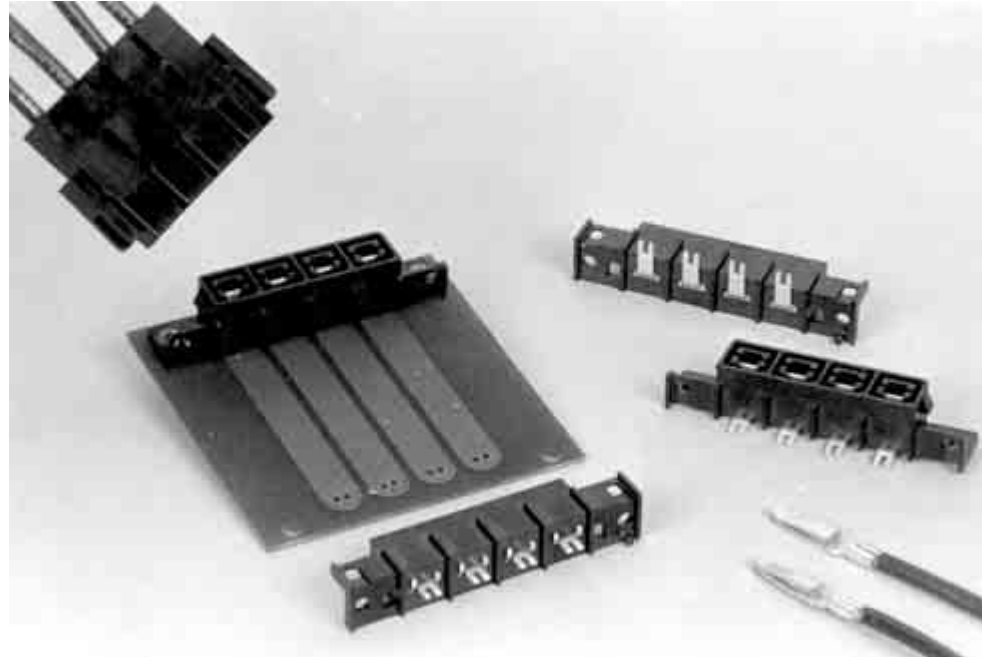

AMPINNERGY Wire-To-Board (WTB) Connectors

Connectors provide a convenient and efficient means of delivering up to 600 VAC to component printed circuit boards and other power distribution devices in computers and peripherals, telephone systems and appliances. The WTB connectors also have automotive and industrial applications.

Receptacles

The AMPINNERGY WTB connector receptacles can be installed on pc boards varying in thickness from .062 inch to .125 inch. A polarizing pin is provided on the vertical receptacle assembly to aid in proper positioning on the pc board. Both the vertical and right-angle assemblies are polarized for accurate mating to the plug assemblies. The receptacle

assemblies are available in contact configurations ranging from two to eight positions.

Plugs

The single piece plug housings are available in contact configurations to mate with the receptacles. The plug is equipped with positive latches to allow full and more secure mating to the respective receptacle.

A make-first/break-last feature is designed into position 1 of the plug assemblies to provide grounding protection.

Contacts

The crimp contacts will accommodate either 10-12 AWG or 14-16-18 AWG conductors. The contacts latch firmly within the plug housing.

AMPINNERGY Wire-To-Board Connectors (Continued)

Vertical PCB Receptacles

Product Facts

- Withstands vapor phase, infrared and wave soldering processes
- .040 inch minimum standoff to PCB
- Polarized to PCB; to plug
- Contact centerline spacing: .440 inch
- Overall height on PCB: .600 inch
- Fits PCB thickness .062 through .125 inch
- Contacts have dual solder posts for efficient heat dissipation, low millivolt drop and mechanical strength
- Positive latching to mating plug

Material and Finish

Housing — Polyphenylene Sulfide, Black, 94V-0

Contacts — Tin Plated Copper Alloy

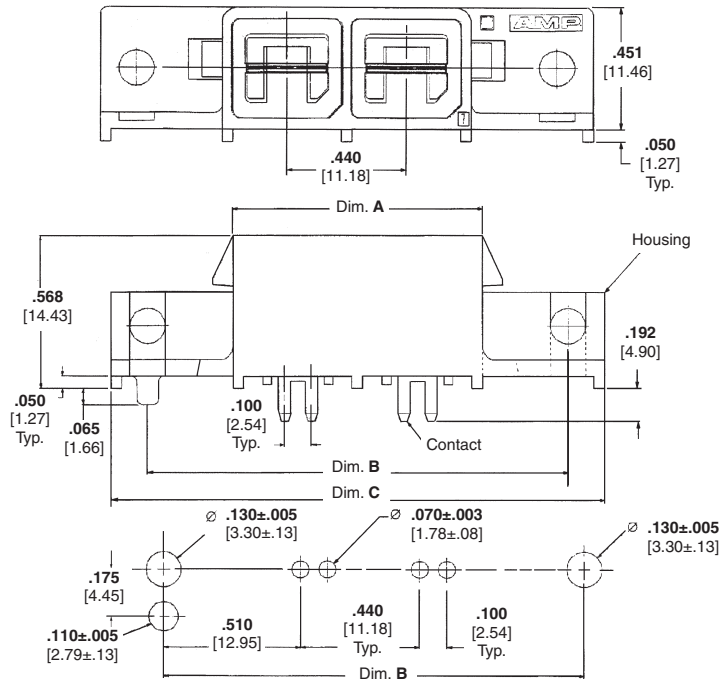
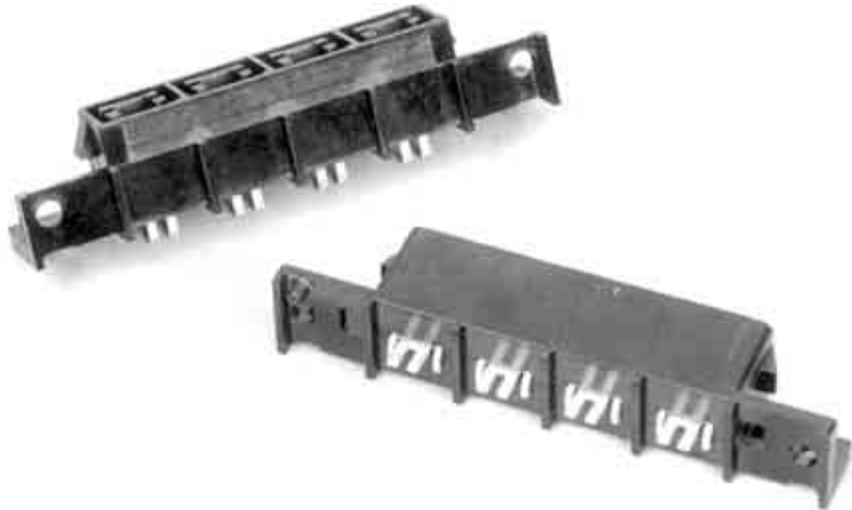

PCB Thickness — .062-.125 inch

No. of Positions	Dimensions			Receptacle Part Numbers
	A	B	C	
2	.93 23.50	1.56 39.62	1.84 46.61	556881-2
3	1.37 34.68	2.00 50.80	2.28 57.79	556881-3
4	1.81 45.85	2.44 61.98	2.72 68.97	556881-4
5	2.25 57.03	2.88 73.15	3.16 80.14	556881-5
6	2.69 68.20	3.32 84.33	3.60 91.32	556881-6
7	3.13 79.38	3.76 95.50	4.04 102.49	556881-7
8	3.57 90.56	4.20 106.68	4.48 113.67	556881-8

PCB Thickness — .250 inch

No. of Positions	Receptacle Part Numbers
4	558574-1
6	558084-1

Note: All part numbers are RoHS compliant.

AMPINNERGY Wire-To-Board Connectors (Continued)

Right-Angle PCB Receptacles

Product Facts

- Withstands vapor phase, infrared and wave soldering processes
- .040 inch minimum standoff to PCB
- Receptacles polarized to plug
- Contact centerline spacing: .440 inch
- Overall height on PCB: .600 inch
- Fits PCB thickness .062 through .125 inch
- Contacts have dual solder posts for efficient heat dissipation, low millivolt drop and mechanical strength
- Positive latching to mating plug

Material and Finish

Housing — Polyphenylene Sulfide, Black, 94V-0

Contacts — Tin Plated Copper Alloy

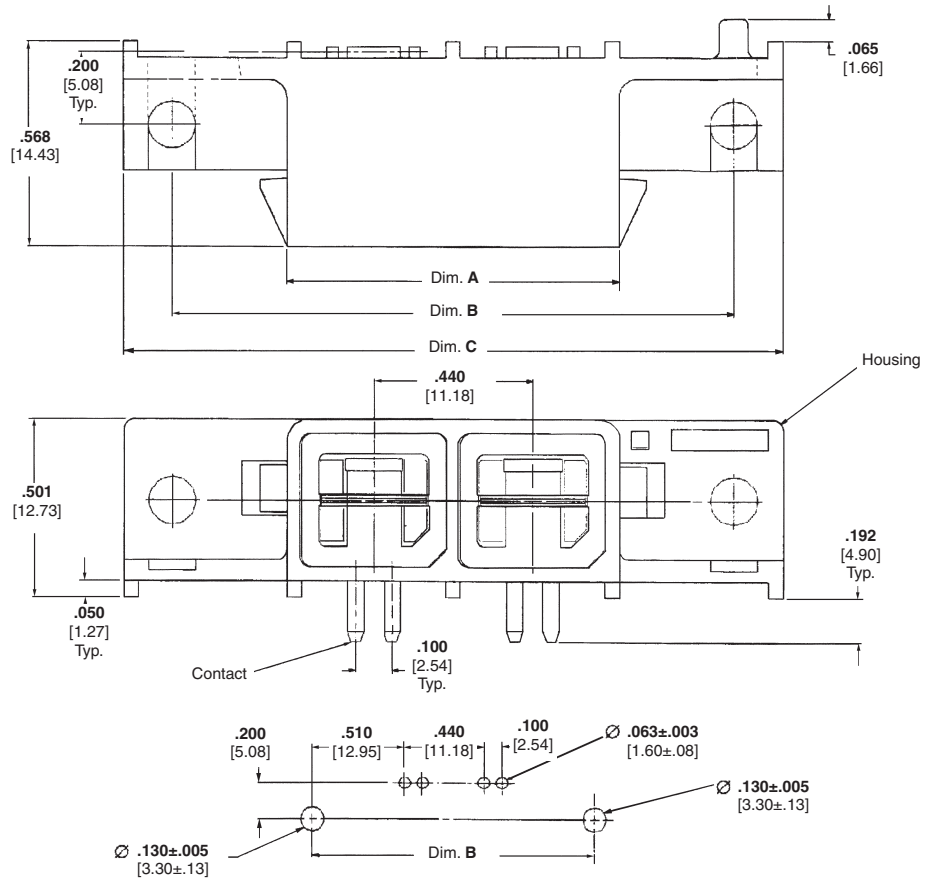
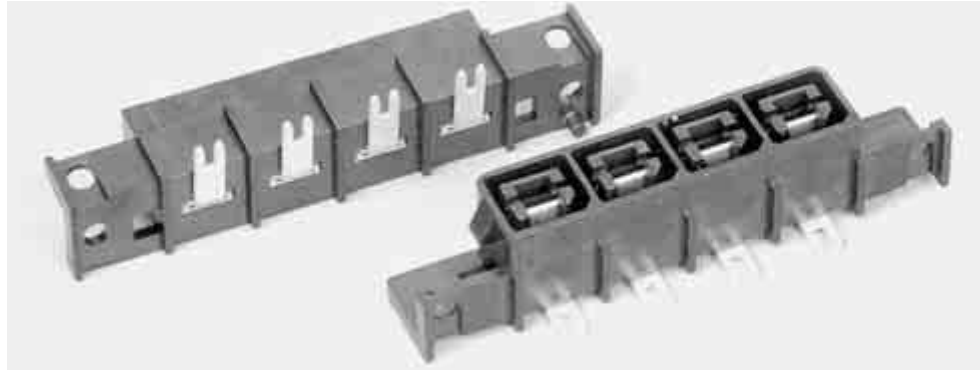

PCB Thickness — .062-.125 inch

No. of Positions	Dimensions			Receptacle Part Numbers
	A	B	C	
2	.93 23.50	1.56 39.62	1.84 46.61	556882-2
3	1.37 34.68	2.00 50.80	2.28 57.79	556882-3
4	1.81 45.85	2.44 61.98	2.72 68.97	556882-4
5	2.25 57.03	2.88 73.15	3.16 80.14	556882-5
6	2.69 68.20	3.32 84.33	3.60 91.32	556882-6
7	3.13 79.38	3.76 95.50	4.04 102.49	556882-7
8	3.57 90.56	4.20 106.68	4.48 113.67	556882-8

Note: All part numbers are RoHS compliant.

AMPINNERGY Wire-To-Board Connectors (Continued)

Plug Housings

Product Facts

- One-piece housing
- Polarized to mating receptacles
- Positive latching to mating receptacles
- Accepts crimp contacts
Part Numbers 556880-2 and 556883-1
- Internal latching of crimp contact

Material

Housing — Polycarbonate,
Black, 94V-0



No. of Positions	Dimensions		Plug Part Numbers
	A	B	
2	.85 21.42	1.20 30.31	556879-2
3	1.29 32.59	1.64 41.48	556879-3
4	1.73 43.77	2.08 52.66	556879-4
5	2.17 54.94	2.52 63.83	556879-5
6	2.61 77.30	2.96 75.01	556879-6
7	3.05 77.30	3.40 86.19	556879-7
8	3.49 88.47	3.84 97.36	556879-8

Note: All part numbers are RoHS compliant.

AMPINNERGY Wire-To-Board Connectors (Continued)

Crimp Contacts

Product Facts

- Contacts are dual beam design

Material and Finish

Contacts—Tin Plated Copper Alloy



Cable Mounted Products

Wire barrel accepts one 10 or 12 AWG stranded copper conductor

- Part Number** 556880-2 Strip
- Part Number** 556880-1 Loose Piece

Application Tooling

Applicator Part Number

- 567256-3 (for Lead Makers)
- 567256-4 (for AMP-O-ELECTRIC Model K Machine)
- 567256-6 (for AMP-O-ELECTRIC Model G Machine)



Wire barrel accepts one 14, 16 or 18 AWG stranded copper conductor

- Part Number** 556883-1 Loose Piece
- Part Number** 556883-2 Strip

Application Tooling Part Number

- 69710-1 Hand Tool
- 58492-1 Die Set (14 AWG)
- 58493-1 Die Set (18-16 AWG)
- 91308-1 Extraction Tool



Note: All part numbers are RoHS compliant.

Circular (CPC) Connectors for Commercial Signal and Power Applications

Product Facts

- Lightweight, all-plastic and metal-shell connectors
- CPC connectors are UL 94V-0 rated and made of stabilized, heat resistant, self-extinguishing thermo-plastic material
- Metal-shell CPC connector housings made of UL 94V-0 rated thermoplastic
- Operating temperature range: -55°C to +125°C
- Available in panel- or chassis-mount and free-hanging configurations
- Quick connect/disconnect capability with thread assist, positive detent coupling
- Built-in pin and socket protection
- Polarized for proper mating of connector halves
- Special connector configurations offer special solder and posted contacts, special receptacles with or without threaded inserts
- Full complement of optional accessories
- Recognized under the Component Program of Underwriters Laboratories Inc.  for 250 VAC, rms or 250 VDC, Service‡; Series 1 and Series 3 (600 V); Series 2, Series 4, Series 5 and Series 6 (250 V) File No. E28476

‡Select connectors are recognized for 600 volts service.

- Certified by Canadian Standards Association,  File No. LR 7189
- Certain products meet VDE Standard 0627 



- Produced under a Quality Management System certified to ISO 9001

A copy of the certificate is available upon request.

Connector series for different interconnection requirements:

- Series 3 — Low density, power applications with Type XII contacts capable of carrying up to 35 Amps of current
- Series 4 — Combination of standard and power density application with Type III+ and Type XII contacts
- Series 5 — Power density application with Size 8 screw machined and precision formed contacts
- Series 6 — Combination of standard and power density application with Type III+ and Size 8 contacts

Type XII, Precision Formed, Crimp Contacts



Male

Female

High Current Type XII Crimp Contacts



High Current Type XII Socket

High Current Type XII Pin

For more information, request Catalog 82021.

Circular (CPC) Connectors for Commercial Signal and Power Applications (Continued)

Connector Series and Types

Cable Mounted Products



Series 3 — Power Contacts

Series 3 connectors accept Type XII power contacts which can carry up to 25 Amps per contact. These contacts will accommodate a wire size range of 16 to

10 AWG [1.4 to 5 mm²]. Two connector sizes are available in both standard and reverse sex connector arrangements **3 and 7 positions**.

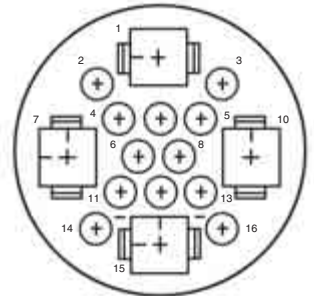

Series 4 — Combination Size 16 and Power Contacts

Series 4 connectors accept Size 16 Multimate and Type XII power contacts, combining the signal and coaxial circuit capabilities of Series 1 connectors with the

power circuit capabilities of Series 3 connectors. Available in two connector sizes offering power mixing combinations totaling **16 and 22 positions**.



Series 5 — Power Contacts .125 POWERBAND

Series 5 connectors combine the revolutionary performance of the new POWERBAND Contact, high current contact in configurations similar to the Series 3 connectors. POWERBAND contacts offer the electrical perform-

ance of the best Mil Spec Size 8 screw-machined contacts with the economy and productivity of strip-fed, precision formed contacts. Series 5 connectors are environmentally sealable to meet IEC IP 65 and IP 67 specifications.

Rated at 600 VAC or VDC, 45 Amps maximum in a single contact, the connectors are available in free-hanging and panel-mount applications — **one connector configuration containing three .125 POWERBAND contacts**.



Series 6 — Combination, Size 16 and .125 POWERBAND Contacts

Series 6 combines the high current and environmental sealing capability of Series 5, POWERBAND contacts, and the reliability of signal carrying, low current Type III+ contacts. This

combination of power and signal contacts is offered in **one connector configuration containing two .125 POWERBAND contacts and eight Type III+ signal pin and socket contacts**.

For more information, request Catalog 82021.

Circular (CPC) Connectors for Commercial Signal and Power Applications (Continued)

Connector Series and Types
(Continued)



Metal-Shell, Circular Plastic Connectors (Series 3 and 4)

Metal-Shell CPC connectors consist of a black thermoplastic insert in a nickel-plated, zinc alloy shell. These connectors

are currently available in **shell sizes 14, 22 and 28, and in two basic configurations consisting of plugs and square flange receptacles.**



Miniature CPC Connectors

These compact connectors accept existing Mini-Universal MATE-N-LOK pin and socket contacts, 30-18 AWG [.05-.8 mm²].

Two shell sizes (8 or 11) are available, accommodating **from 1 to 4 and 5 to 9 positions.**

Featuring high contact density and IP67 sealing, these durable connectors are well suited for many wire-to-wire, wire-to-board, and wire-to-panel applications.

For more information, request Catalog 82021.

High Current Products (LOUVERTAC Contacts)

Product Facts

- Pins and sockets have low insertion force
- High current ratings with very low resistance
- All plated products are gold or silver plated
- LOUVERTAC bands have a temperature range from -196°C to +200°C available
- Formed bands are available for up to 1.250 [31.75] pin diameter

The transfer of high current with manageable insertion and withdrawal forces has always presented a challenge to the connector industry.

LOUVERTAC bands provide a unique means of transferring high amperage with a resultant space and weight savings. Tyco Electronics

offers a wide range of pin and socket sizes for your applications. Strip and formed LOUVERTAC bands are also offered for customer use in their own contact design. The wide variety of flat and formed male and female bands provide the ability to design electrical connections more

inexpensively and quickly. LOUVERTAC products are your high current applications solution.

The variety of pins and sockets available from Tyco Electronics provide a quick and simple solution to most high current applications.

Cable Mounted Products



High Current Products (LOUVERTAC Contacts) (Continued)

Thread-Mount Sockets

These sockets are designed for easy installation and removal. The large variety of sizes have ratings from 30 continuous Amps and can be mated with Thread-Mount Pins and Crimp Pins.

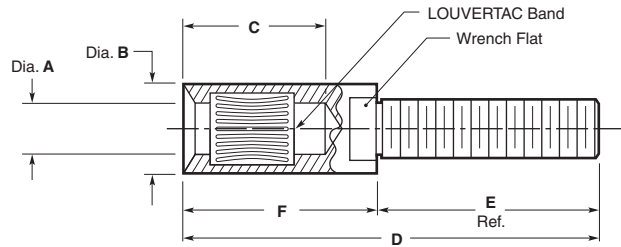
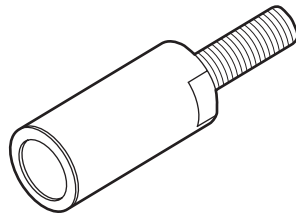

Material

Body — Brass

LOUVERTAC Band — Beryllium Copper

Finish

Body — Silver

LOUVERTAC Band — See Table

Mating Pin Dia.	Part Number	Thread	Contin. Current (Amp)	Voltage Drop (mV)	Dimensions						LOUVERTAC Band Plating
					A Dia.	B Dia.	C	D	E Ref.	F	
2 mm	192059-1	M3x0.5	30	12	.080 2.0	.220 5.6	.670 17.0	1.42 36.1	.630 16	.790 20.1	Silver
4 mm	192129-1	10-32	60	10	.160 4.1	.280 7.1	.790 20.1	2.00 50.8	1.00 25.4	1.00 25.4	Gold
6 mm	192211-1	1/4-28	100	11	.240 6.1	.410 10.4	.800 20.3	2.09 53.1	1.00 25.4	1.09 27.7	Gold
8 mm	192271-1	5/16-24	185	12	.320 8.1	.560 14.2	1.40 35.6	3.07 78	1.42 36.0	1.65 41.9	Silver

Thread-Mount Pins

These pins are designed for thread-mount. The large variety of sizes have ratings from 30 continuous Amps and are designed to be mated with Thread-Mount Sockets, Threaded Sleeve Sockets and Crimp Sockets.



Material — Brass

Finish — Silver

Pin Dia.	Part Number	Thread	Contin. Current (Amp)	Dimensions				
				A Dia.	B	C	D	E Ref.
2 mm	192085-1	M3x0.5	30	.080 2.0	.16 4.1	.65 16.5	1.40 35.6	.63 15.0
4 mm	192161-1	10-32	60	.160 4.1	.25 6.4	.77 19.6	1.91 48.5	.99 25.1
6 mm	192244-1	1/4-28	100	.240 6.1	.31 7.9	.77 19.6	2.03 51.6	1.11 25.2
8 mm	192293-1	5/16-24	185	.320 8.1	.44 11.2	1.30 33.0	2.95 74.9	1.47 37.3

Note: All part numbers are RoHS compliant.

High Current Products (LOUVERTAC Contacts) (Continued)

Threaded Sleeve Sockets

The Threaded Sleeve Socket Assembly is designed for High Current in a restricted space. The Sleeve can be screwed directly into a threaded bus bar or it may be inserted into a drilled hole in the bus bar with tightened nuts on each side of the bus bar. A Crimp Pin or Thread-Mount Pin can be attached to a cable for the completed connector.

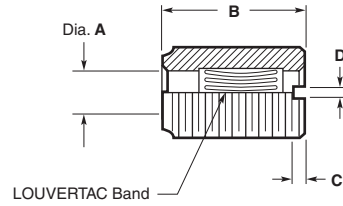
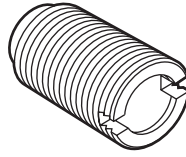

Material

Body — Brass

LOUVERTAC Band —
Beryllium Copper

Finish

Body — Silver

LOUVERTAC Band —
See Table

Mating Pin Dia.	Part Number	Thread	Contin. Current (Amp)	Voltage Drop (mV)	Dimensions				LOUVERTAC Band Plating
					A Dia.	B	C	D	
2 mm	1-192447-0	5/16-32	30	12	.090 2.3	.650 16.5	.060 1.5	.060 1.5	Silver
4 mm	192447-8	5/16-32	60	10	.160 4.1	.770 19.6	.060 1.5	.060 1.5	Gold
6 mm	192447-2	1/2-20	100	11	.240 6.1	.770 19.6	.078 2.0	.078 2.0	Gold
8 mm	1-192447-8	9/16-18	185	12	.320 8.1	1.35 34.3	.100 2.5	.100 2.5	Silver
12 mm	1-192447-2	3/4-16 UNF -2A	290	13	.479 12.2	1.34 34.0	.130 3.3	.130 3.3	Silver

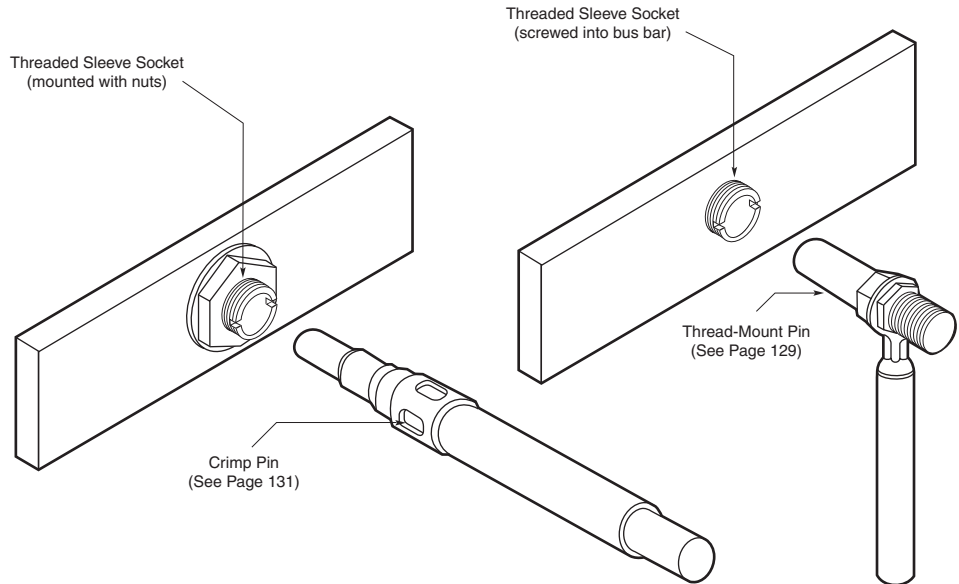

Note: All part numbers are RoHS compliant.

High Current Products (LOUVERTAC Contacts) (Continued)

Crimp Pins

Crimp Pins feature a mechanism for locking the pin into a housing designed by the customer. The 2 mm and 4 mm pins are crimped with a Daniels Hand Crimp Tool. Pin sizes from 6 mm to 8 mm may be crimped with the indicated tooling and a DYNA-CRIMP 69120-1 electric-hydraulic power unit. The large variety of sizes have ratings from 24 continuous Amps and can be mated with Thread-Mount Socket Assemblies, Threaded Sleeve Socket Assemblies or Crimp Sockets.



Material

Body — Copper Alloy

Retention Spring — Stainless Steel or Beryllium Copper

Finish

Body — Silver

Pin Dia.	Part Number	Contin. Current (Amp)	Voltage Drop (mV)	Dimensions							Use with AWG	Tooling Part Numbers		
				A	B Dia.	C Dia.	D	E	F	G Dia.		Crimp Die	Crimp Head	Extraction Tool
2 mm	193837-1	30	12	1.40 35.6	.225 5.72	.100 2.54	.640 16.3	.211 5.36	.050 1.27	.080 2.0	12-14	M310	TP1019	318813-1
	193837-2	44	8	1.53 38.9	.300 7.6	.145 3.7	.750 19.1	.211 5.36	.050 1.27	.160 4.0	10	M310	TP1020	679916-1
4 mm	193837-3	60	8	1.53 38.9	.300 7.6	.181 4.60	.750 19.1	.211 5.36	.050 1.27	.160 4.0	8	M310	TP1020	679916-1
	193837-4	76	9	1.64 41.7	.410 10.4	.235 5.97	.760 19.3	.211 5.36	.050 1.27	.240 6.0	6	69133-1	69099	679917-1
6 mm	193837-5	100	9	1.73 43.9	.410 10.4	.290 7.37	.760 19.3	.211 5.36	.050 1.27	.240 6.0	4	69134-2	69099	679917-1
	193837-6	135	10	2.50 63.5	.570 14.5	.390 9.91	1.30 33.0	.211 5.36	.050 1.27	.320 8.0	2	46765-3	69099	679918-1
8 mm	193837-7	185	12	2.63 66.8	.570 14.5	.487 12.37	1.30 33.0	.211 5.36	.050 1.27	.320 8.0	1/0	46766-2	69099	679918-1

Notes: 1. Additional information on AMPPOWER terminal hydraulic crimping is available in Catalog 82025.
2. Application Specification — 114-16022

Note: All part numbers are RoHS compliant.

High Current Products (LOUVERTAC Contacts) (Continued)

Crimp Sockets

Crimp Sockets feature a mechanism for locking the socket into a housing designed by the customer. A Tyco Electronics extraction tool is offered to remove the contact. The 2 mm and 4 mm sockets are crimped with a Daniels Hand Crimp Tool. Socket sizes from 6 mm to 8 mm may be crimped with the indicated tooling and a DYNA-CRIMP 69120-1 electric-hydraulic power unit. The large variety of sizes have ratings from 24 continuous Amps and can be mated with Thread-Mount Pins or Crimp Pins.

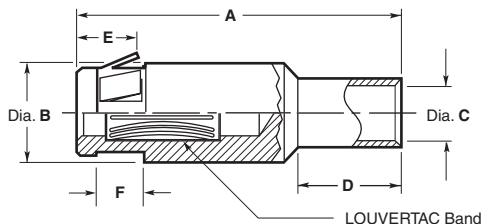

Material

Body — Copper Alloy

LOUVERTAC Band — Beryllium Copper

Retention Spring — Stainless Steel or Beryllium Copper

Finish

Body — Silver

LOUVERTAC Band — Silver

Mating Pin Dia.	Part Number	Contin. Current (Amp)	Voltage Drop (mV)	Dimensions						Use with AWG	Tooling Part Numbers		
				A	B Dia.	C Dia.	D	E	F		Crimp Die	Crimp Head	Extraction Tool
2 mm	193673-1	24	10	1.13 28.7	.230 5.8	.100 2.54	.420 10.7	.211 5.36	.209 5.31	14	M310	TP1021	318813-1
	193673-1	30	12	1.13 28.7	.230 5.8	.100 2.54	.420 10.7	.211 5.36	.209 5.31	12	M310	TP1021	318813-1
4 mm	193673-2	44	8	1.31 33.3	.300 7.6	.145 3.68	.400 10.2	.211 5.36	.209 5.31	10	M310	TP1022	679916-1
	193673-3	60	8	1.31 33.3	.300 7.6	.181 4.60	.410 10.4	.211 5.36	.209 5.31	8	M310	TP1022	679916-1
6 mm	193673-4	76	9	1.42 36.1	.410 10.4	.235 5.97	.460 11.7	.211 5.36	.209 5.31	6	69133-1	69099	679917-1
	193673-5	100	9	1.48 37.6	.410 10.4	.290 7.37	.530 13.5	.211 5.36	.209 5.31	4	69134-2	69099	679917-1
8 mm	193673-6	135	10	2.26 57.4	.570 14.5	.390 9.91	.640 16.3	.211 5.36	.209 5.31	2	46765-3	69099	679918-1
	193673-7	185	12	2.45 62.2	.570 14.5	.487 12.37	—	.211 5.36	.209 5.31	1/0	46766-2	69099	679918-1
12 mm	193673-8*	290	13	2.51 63.7	.795 20.19	.541 13.74	.930 23.62	—	—	2/0	46767-2	69099	—
20 mm	1-193673-2*	480	11	3.17 80.5	1.072 27.23	.721 18.31	1.24 31.50	—	—	250 MCM	46751-2	69099	—

* Socket contact uses retention ring (not supplied) for locking contact in housing. See Application Specification 114-16022 for details.

Notes: 1. Additional information on AMPPOWER terminal hydraulic crimping is available in Catalog 82025.
2. Application Specification — 114-16022

Note: All part numbers are RoHS compliant.

High Current Products (LOUVERTAC Contacts) (Continued)

Thread-Mount Fork

The Thread-Mount Fork was developed to mount onto a plate or bus bar designed and fabricated by the customer. The Fork is rated at 84 Amps (Upper Tolerance Limit) and accepts a .087 thick blade or circuit board. The anti-rotation pin is in place to help prevent the Fork from rotating while tightening the screw.

Material

Fork — Zinc Al Alloy
LOUVERTAC Bands — Copper Alloy
Screw — Steel

Finish

Fork — Silver
LOUVERTAC Bands — Silver
Screw — Zinc

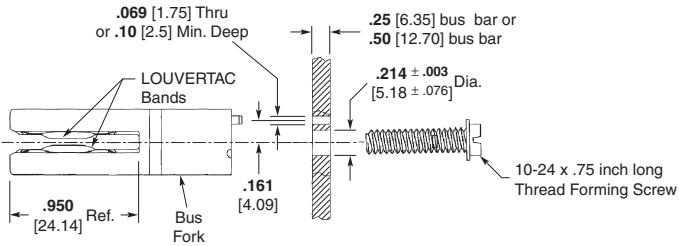
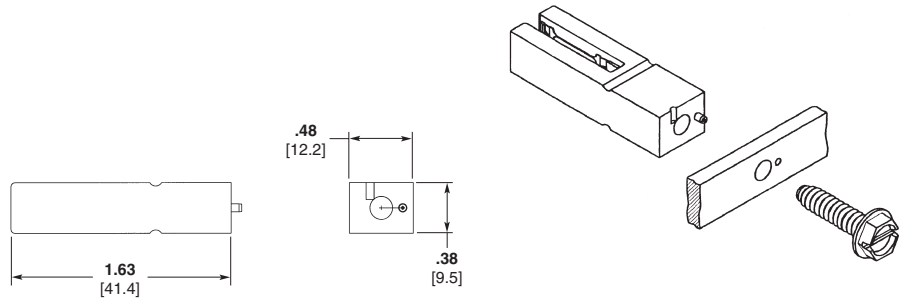

Part Number 194257-1

Right-Angle Thread-Mount Fork

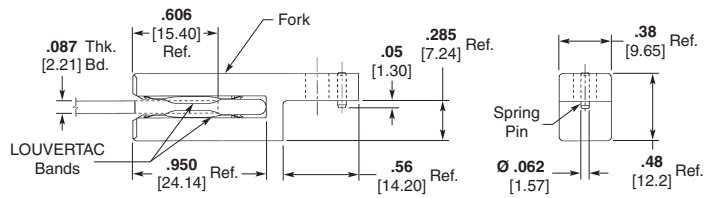
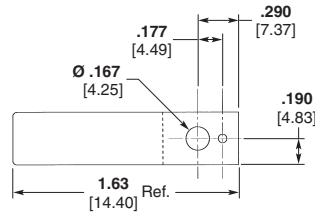

Part Number 194305-1

Material

Fork — Zinc Al Alloy
LOUVERTAC Bands — Copper Alloy
Spring Pin — Stainless Steel

Finish

Fork — Silver
LOUVERTAC Bands — Silver

Note: All part numbers are RoHS compliant.

High Current Products (LOUVERTAC Contacts) (Continued)

**LOUVERTAC Strip,
Torsional Louver Type**

The Torsional Louver Type Band was designed as an electrical interface that allows the transfer of high current and a more generous tolerance between mating surfaces. A strip can be sized with scissors in an on-site installation. They are available for use in flat and circular applications. A male band is used on the outside diameter of a pin. The female band is used on the inside diameter of a socket.

Material — Beryllium Copper

Finish — See Tables

**LAO
.092 [2.27] Louver Height**

Tooth Angle — 15°
Minimum Diameter — 1.75 inches

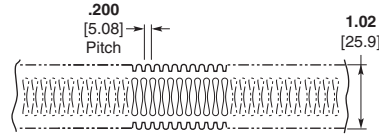

Part Number	Application	Material Thickness	Suggested Current Limit per inch	Finish
192000-2	Flat or Female	.006 .15	150	Silver
192000-9	Flat or Female	.010 .25	250	Silver
192001-4	Flat or Male	.006 .15	150	Silver

**LAOG
Louver Height — See Table**

Tooth Angle — 45°
Minimum Diameter — 1.75 inches



Part Number	Application	Material Thickness	Suggested Current Limit per inch	Louver Height	Finish
192002-1	Flat or Female	.006 .15	300	.105 2.67	Unplated
192002-2	Flat or Female	.006 .15	300	.105 2.67	Silver
192002-3	Flat or Female	.010 .25	500	.110 2.79	Unplated

**LAIA
.050 [1.27] Louver Height**

Tooth Angle — See Table
Minimum Diameter — 1½ inches



Part Number	Application	Material Thickness	Suggested Current Limit per inch	Tooth Angle	Finish
192004-4	Flat or Female	.004 .10	150	15°	Silver
192004-6	Flat or Female	.004 .10	150	45°	Silver
192004-8	Flat or Female	.006 .15	250	15°	Silver
1-192004-1	Flat or Female	.006 .15	250	15°	Gold
1-192004-4	Flat or Female	.006 .15	250	45°	Silver
192007-7	Flat or Male	.006 .15	250	15°	Silver
192008-1	Flat or Male	.004 .10	150	45°	Silver

- Notes:** 1. Product will be sold by the foot except where length is specified.
2. Suggested current limits are application dependent.
3. Additional sizes are available upon request.

Note: All part numbers are RoHS compliant.

High Current Products (LOUVERTAC Contacts) (Continued)

LOUVERTAC Strip, Bridge Louver Type

The Bridge Louver Type Band was designed to transfer high currents in very small spaces. A strip can be sized with scissors in an on-site installation. They are available for use in flat and circular applications. A male band is used on the outside diameter of a pin. The female band is used on the inside diameter of a socket.

Material—Beryllium Copper

LAIII
.034 [.86] Louver Height

Minimum Diameter — 1 inch
Suggested Current Limit
Per Inch — 150 Amps
Material Thickness — .006 [.15]



Part Number	Application	Finish
192038-6	Female	Silver
192039-5	Male	Silver

LAIV
.026 [.66] Louver Height

Minimum Diameter — 3/4 inch
Suggested Current Limit
Per Inch — 150 Amps
Material Thickness — See Table



Part Number	Application	Finish	Material Thickness
1-192041-2	Female	Silver	.006 .15
192042-5	Male	Silver	.006 .15
192048-2	Male	Gold	.004 .10

LAV
.022 [.56] Louver Height

Minimum Diameter — 3/4 inch
Suggested Current Limit
Per Inch — 120 Amps
Material Thickness — See Table



Part Number	Application	Finish	Material Thickness
1-192044-9	Female	Silver	.005 .13
192045-5	Male	Silver	.005 .13
192045-2	Male	Gold	.004 .10
1-192045-2	Male	Gold	.004 .10

- Notes:** 1. Product will be sold by the foot except where length is specified.
2. Suggested current limits are application dependent.
3. Additional sizes are available upon request.

Note: All part numbers are RoHS compliant.

High Current Products (LOUVERTAC Contacts) (Continued)

Preformed Female LOUVERTAC Bands

Female Torsional Formed Type

**LA1A/LA1B
.050 [1.27] Louver Height**

Material — Beryllium Copper

Finish — See Table

Tooth Angle — See Table



Cable Mounted Products

LOUVERTAC Bands can be manufactured as preformed diameters. This will allow the insertion of the band into a socket.

The diameter indicated is the mating pin diameter that will be inserted into the socket assembly.

Consult Product Engineering for mounting details.

Part Number	Mating Pin Dia.	Material Thickness	Suggested Current Limit (A)	Finish	Tooth Angle	Band Type
4-192013-3	.312 [7.92]	.004 [.10]	150	Silver	15°	LA1A
4-192013-5	.312 [7.92]	.006 [.15]	250	Silver	15°	LA1A
5-192013-1	.355 [9.01]	.006 [.15]	275	Gold	15°	LA1A
5-192013-4	.375 [9.53]	.006 [.15]	300	Silver	15°	LA1A
5-192013-5	.394 [10.00]	.006 [.15]	325	Silver	15°	LA1A
5-192013-8	.434 [11.02]	.006 [.15]	350	Gold	15°	LA1A
5-192013-9	.437 [11.10]	.006 [.15]	350	Silver	15°	LA1A
6-192013-7	.472 [11.99]	.006 [.15]	375	Silver	15°	LA1A
6-192013-9	.472 [11.99]	.008 [.20]	375	Silver	15°	LA1A
7-192013-1	.500 [12.70]	.006 [.15]	400	Silver	15°	LA1A
7-192013-6	.551 [14.00]	.006 [.15]	450	Silver	15°	LA1A
8-192013-2	.625 [15.88]	.006 [.15]	500	Silver	15°	LA1A
8-192013-6	.625 [15.88]	.008 [.20]	475	Silver	15°	LA1A
8-192013-9	.685 [17.40]	.006 [.15]	550	Silver	15°	LA1A
9-192013-6	.750 [19.05]	.006 [.15]	600	Silver	15°	LA1A
192033-3	.750 [19.05]	.008 [.20]	600	Silver	15°	LA1A
1-192033-9	.875 [22.22]	.006 [.15]	675	Gold	15°	LA1A
2-192033-0	.875 [22.22]	.006 [.15]	700	Silver	15°	LA1A
2-192033-6	1.000 [25.40]	.006 [.15]	775	Silver	15°	LA1A
3-192033-4	1.250 [31.75]	.006 [.15]	975	Silver	15°	LA1A
5-192033-2	1.000 [25.40]	.008 [.20]	800	Silver	15°	LA1A
3-192013-8	1.187 [30.10]	.006 [.15]	950	Silver	45°	LA1B
5-192033-0	.812 [20.62]	.008 [.20]	625	Silver	45°	LA1B

Notes: 1. Suggested current limits are application dependent.
2. Additional sizes are available upon request.

Note: All part numbers are RoHS compliant.

High Current Products (LOUVERTAC Contacts) (Continued)
Preformed Female LOUVERTAC Bands

(Continued)

Female Bridge Formed Type LAIII through LAVI
Material — Beryllium Copper

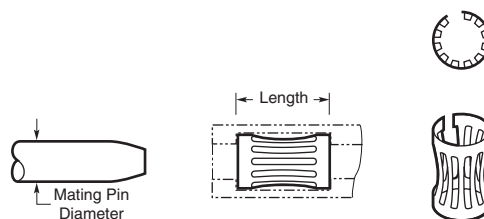
Finish — See Table

Part Number	Mating Pin Dia.	Length	Material Thickness	Suggested Current Limit (A)	Finish	Band Type
1-192038-9	.125 [3.18]	.47 [11.9]	.004 [.10]	40	Nickel	LAIII
2-192038-8	.197 [5.00]	.47 [11.9]	.006 [.15]	90	Gold	LAIII
3-192038-7	.236 [6.00]	.47 [11.9]	.006 [.15]	100	Gold	LAIII
4-192038-0	.236 [6.00]	.47 [11.9]	.008 [.20]	120	Gold	LAIII
4-192038-1	.236 [6.00]	.47 [11.9]	.008 [.20]	120	Gold	LAIII
4-192038-8	.250 [6.35]	.47 [11.9]	.006 [.15]	110	Silver	LAIII
4-192038-9	.250 [6.35]	.47 [11.9]	.006 [.15]	110	Gold	LAIII
5-192038-4	.250 [6.35]	.47 [11.9]	.008 [.20]	125	Gold	LAIII
6-192038-0	.280 [7.11]	.47 [11.9]	.008 [.20]	165	Silver	LAIII
6-192038-1	.280 [7.11]	.47 [11.9]	.008 [.20]	125	Gold	LAIII
6-192038-2	.250 [6.35]	.47 [11.9]	.006 [.15]	125	Unplated	LAIII
6-192038-5	.315 [8.00]	.47 [11.9]	.008 [.20]	185	Silver	LAIII
6-192038-6	.315 [8.00]	.47 [11.9]	.008 [.20]	185	Gold	LAIII
7-192038-7	.394 [10.00]	.47 [11.9]	.008 [.20]	250	Silver	LAIII
8-192038-1	.437 [11.10]	.47 [11.9]	.008 [.20]	270	Silver	LAIII
8-192038-6	.472 [11.99]	.47 [11.9]	.008 [.20]	300	Silver	LAIII
9-192038-4	.500 [12.70]	.47 [11.9]	.008 [.20]	300	Tin	LAIII
192040-8	.375 [9.53]	.47 [11.9]	.008 [.20]	200	Gold	LAIII
2-192040-7	.250 [6.35]	.47 [11.9]	.006 [.15]	110	Gold	LAIII
2-192041-9	.025 [0.64]	.32 [8.13]	.005 [.13]	15	Gold	LAIV
4-192041-0	.062 [1.57]	.32 [8.13]	.006 [.15]	25	Silver	LAIV
4-192041-1	.062 [1.57]	.32 [8.13]	.006 [.15]	25	Gold	LAIV
4-192041-4	.080 [2.03]	.32 [8.13]	.006 [.15]	35	Gold	LAIV
5-192041-0	.093 [2.36]	.32 [8.13]	.005 [.13]	40	Gold	LAIV
5-192041-9	.100 [2.54]	.32 [8.13]	.006 [.15]	50	Gold	LAIV
6-192041-9	.125 [3.18]	.32 [8.13]	.006 [.15]	60	Gold	LAIV
7-192041-4	.157 [4.00]	.32 [8.13]	.006 [.15]	65	Gold	LAIV
7-192041-7	.157 [4.00]	.32 [8.13]	.006 [.15]	65	Silver	LAIV
7-192041-8	.157 [4.00]	.32 [8.13]	.006 [.15]	65	Gold	LAIV
8-192041-4	.157 [4.00]	.32 [8.13]	.008 [.20]	75	Gold	LAIV
8-192041-9	.173 [4.39]	.32 [8.13]	.006 [.15]	70	Gold	LAIV
192043-6	.218 [5.54]	.32 [8.13]	.006 [.15]	95	Silver	LAIV
1-192043-5	.254 [6.45]	.32 [8.13]	.006 [.15]	110	Silver	LAIV
1-192043-6	.250 [6.35]	.32 [8.13]	.006 [.15]	120	Gold	LAIV
2-192043-0	.280 [7.11]	.32 [8.13]	.006 [.15]	130	Gold	LAIV
2-192043-7	.315 [8.00]	.32 [8.13]	.006 [.15]	165	Silver	LAIV
4-192043-5	.375 [9.53]	.32 [8.13]	.006 [.15]	175	Gold	LAIV
5-192043-0	.375 [9.50]	.32 [8.13]	.007 [.18]	175	Tin	LAIV
6-192043-7	.602 [15.30]	.32 [8.13]	.006 [.15]	285	Gold	LAIV
7-192043-2	.125 [3.18]	.32 [8.13]	.006 [.15]	60	Silver	LAIV
9-192043-3	.157 [4.00]	.32 [8.13]	.006 [.15]	65	Silver	LAIV
9-192043-6	.725 [18.40]	.32 [8.13]	.006 [.15]	350	Silver	LAIV
4-192044-1	.030 [0.76]	.20 [5.10]	.005 [.13]	13	Gold	LAV
4-192044-2	.030 [0.76]	.20 [5.10]	.005 [.13]	11	Unplated	LAV
4-192044-4	.055 [1.40]	.20 [5.10]	.005 [.13]	20	Gold	LAV
4-192044-7	.060 [1.54]	.20 [5.10]	.004 [.10]	22	Gold	LAV
5-192044-6	.062 [1.57]	.20 [5.10]	.005 [.13]	25	Gold	LAV
5-192044-8	.065 [1.65]	.20 [5.10]	.005 [.13]	23	Unplated	LAV
6-192044-0	.080 [2.03]	.20 [5.10]	.004 [.10]	30	Silver	LAV
6-192044-4	.080 [2.03]	.20 [5.10]	.005 [.13]	30	Gold	LAV

Note: All part numbers are RoHS compliant.

Notes: 1. Suggested current limits are application dependent.
 2. Additional sizes are available upon request.

High Current Products (LOUVERTAC Contacts) (Continued)

Preformed Female LOUVERTAC Bands

(Continued)

Female Bridge Formed Type LAIII through LAVI

(Continued)

Material — Beryllium Copper

Finish — See Table

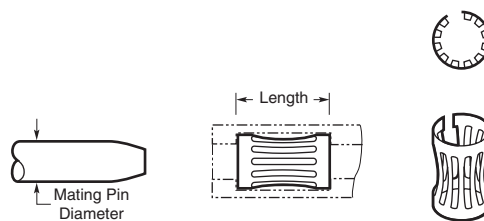

Part Number	Mating Pin Dia.	Length	Material Thickness	Suggested Current Limit (A)	Finish	Band Type
6-192044-6	.080 [2.03]	.20 [5.10]	.008 [.20]	30	Gold	LAV
7-192044-1	.093 [2.36]	.20 [5.10]	.005 [.13]	35	Gold	LAV
8-192044-1	.125 [3.18]	.20 [5.10]	.004 [.10]	45	Gold	LAV
8-192044-3	.125 [3.18]	.20 [5.10]	.005 [.13]	45	Silver	LAV
8-192044-4	.125 [3.18]	.20 [5.10]	.005 [.13]	45	Gold	LAV
8-192044-7	.125 [3.18]	.20 [5.10]	.005 [.13]	45	Unplated	LAV
192046-6	.172 [4.40]	.20 [5.10]	.006 [.15]	65	Gold	LAV
1-192046-6	.225 [5.70]	.20 [5.10]	.006 [.15]	85	Gold	LAV
1-192046-9	.250 [6.35]	.20 [5.10]	.006 [.15]	110	Gold	LAV
2-192046-0	.250 [6.30]	.20 [5.10]	.006 [.15]	95	Tin	LAV
3-192046-0	.400 [10.2]	.20 [5.10]	.005 [.13]	150	Gold	LAV
5-192046-0	.750 [19.0]	.20 [5.10]	.005 [.13]	285	Gold	LAV
5-192046-9	.134 [3.40]	.20 [5.10]	.006 [.15]	50	Gold	LAV
1-192047-4	.040 [1.00]	.10 [2.54]	.004 [.10]	15	Gold	LAVI
1-192047-9	.062 [1.60]	.10 [2.54]	.004 [.10]	22	Gold	LAVI
3-192047-7	.125 [3.20]	.10 [2.54]	.004 [.10]	45	Gold	LAVI
5-192047-1	.256 [6.50]	.10 [2.54]	.004 [.10]	95	Gold	LAVI
5-192047-3	.272 [6.90]	.10 [2.54]	.004 [.10]	65	Gold	LAVI
7-192047-5	.256 [6.50]	.10 [2.54]	.004 [.10]	95	Unplated	LAVI

Note: All part numbers are RoHS compliant.

Notes: 1. Suggested current limits are application dependent.
2. Additional sizes are available upon request.

High Current Products (LOUVERTAC Contacts) (Continued)

Preformed Male LOUVERTAC Bands

Male Torsional Formed Type

LA1AS/LA1BS

Material—Beryllium Copper

Finish—See Table

Tooth Angle—See Table

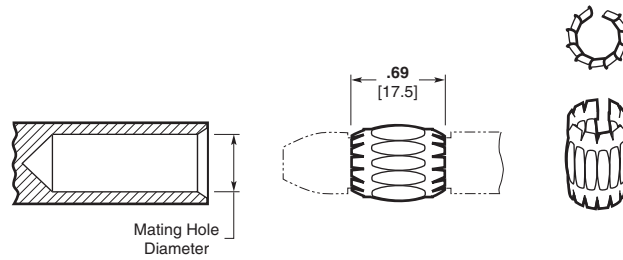

LOUVERTAC Bands can be formed into a "male" shape for use on a pin. Selection begins with the amperage requirement and then the mating hole diameter. Consult Product Engineering for mounting details.

Part Number	Mating Hole Dia.	Material Thickness	Suggested Current Limit (A)	Finish	Tooth Angle	Band Type
192007-9	.312 [7.92]	.006 [.15]	200	Silver	15°	LA1AS
1-192007-9	.620 [15.7]	.006 [.15]	425	Silver	15°	LA1AS
2-192007-5	.750 [19.0]	.008 [.20]	550	Silver	15°	LA1AS
3-192007-1	1.000 [25.4]	.006 [.15]	750	Silver	15°	LA1AS
192008-6	.500 [12.7]	.006 [.15]	350	Silver	45°	LA1BS
1-192008-3	.750 [19.0]	.008 [.20]	550	Silver	45°	LA1BS
1-192008-5	.781 [19.8]	.006 [.15]	575	Silver	45°	LA1BS
2-192008-1	.875 [22.22]	.008 [.20]	650	Silver	45°	LA1BS
3-192008-4	1.197 [30.4]	.008 [.20]	900	Silver	45°	LA1BS
4-192008-2	1.450 [36.8]	.006 [.15]	1100	Silver	45°	LA1BS

Male Bridge Formed Type LAIIIS through LAVIS

Material—Beryllium Copper

Finish—See Table

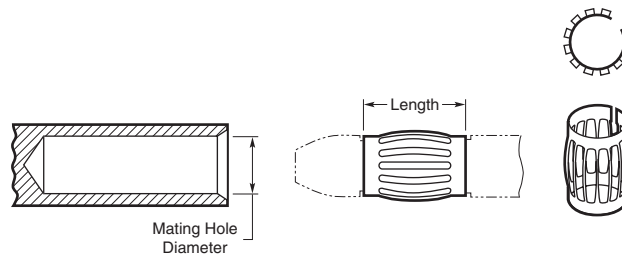

Part Number	Mating Hole Dia.	Length	Material Thickness	Suggested Current Limit (A)	Finish	Band Type
1-192039-7	.157 [4.0]	.470 [11.9]	.008 [.20]	75	Gold	LAIIIS
2-192039-1	.250 [6.35]	.470 [11.9]	.008 [.20]	130	Silver	LAIIIS
2-192039-3	.248 [6.3]	.470 [11.9]	.008 [.20]	130	Silver	LAIIIS
2-192039-7	.311 [7.9]	.470 [11.9]	.008 [.20]	175	Unplated	LAIIIS
2-192039-9	.311 [7.9]	.470 [11.9]	.008 [.20]	175	Silver	LAIIIS
3-192039-0	.311 [7.9]	.470 [11.9]	.008 [.20]	175	Gold	LAIIIS
5-192039-3	.236 [6.0]	.470 [11.9]	.008 [.20]	120	Nickel	LAIIIS
5-192039-4	.157 [4.0]	.470 [11.9]	.008 [.20]	75	Nickel	LAIIIS
1-192042-5	.080 [2.0]	.320 [8.13]	.005 [.12]	30	Nickel	LAVIS
2-192042-5	.157 [4.0]	.320 [8.13]	.006 [.15]	65	Unplated	LAVIS
2-192042-8	.157 [3.99]	.320 [8.13]	.006 [.15]	60	Gold	LAVIS
4-192042-8	.500 [1.27]	.320 [8.13]	.005 [.12]	235	Unplated	LAVIS
6-192042-6	.368 [9.38]	.320 [8.13]	.004 [.10]	170	Unplated	LAVIS
6-192042-7	.375 [9.53]	.320 [8.13]	.006 [.15]	175	Tin	LAVIS
6-192042-8	.375 [9.53]	.320 [8.13]	.006 [.15]	175	Gold	LAVIS
2-192045-3	.250 [6.35]	.200 [5.10]	.006 [.15]	95	Gold	LAVIS
192048-6	.051 [1.3]	.100 [2.54]	.004 [.10]	17	Gold	LAVIS
1-192048-1	.127 [3.23]	.100 [2.54]	.004 [.10]	22	Gold	LAVIS
2-192048-4	.156 [3.96]	.100 [2.54]	.004 [.10]	65	Gold	LAVIS

Note: All part numbers are RoHS compliant.

Notes: 1. Suggested current limits are application dependent.
2. Additional sizes are available upon request.

AMP Power Series Connectors

Product Facts

- Single-pole and 2-pole (battery) quick connect/disconnect connectors
- Eight Series, based on approximate current-carrying capability:
 - Series 15/30/45 (Single-Pole)
 - Series 50 (2-Pole Battery)
 - Series 50 Finger Probe Resistant (FPR)
 - Series 75 (Single-Pole)
 - Series 120 (Single- and 2-Pole)
 - Series 175 (2-Pole Battery)
 - Series 180 (Single-Pole)
 - Series 350 (2-Pole Battery)
- Voltage rating: 600 V AC/DC
- Color-coded housings, UL 94V-0
- Hermaphroditic (genderless) housings reduce inventory
- Modular, single-pole housings are stackable in four directions
- Polarity (+ and -) molded into 2-pole housings promotes proper wiring
- Mechanical keys help prevent two different color-coded housings from mating
- Stainless steel retaining springs secure contacts in housings
- Stamped and formed, open barrel contacts (6-20 AWG) on reels for automatic and semiautomatic machine termination
- Loose piece, cold-headed contacts (6 AWG – 300 MCM) for manual and hydraulic hand tools; reducing bushings accommodate smaller wire sizes
- Compatible with industry standard crimp tooling from Pico Corporation (<http://www.picotools.com>)
- Connectors intermateable with similar connectors from other manufacturers



- Series 15/30/45, single-pole connectors designed to meet Amateur Radio Emergency Service (ARES)/Radio Amateur Civil Emergency Service (RACES) Standard Power Connector requirements
- Accessories available for mounting, vibration protection, and strain relief
- Component Recognized by Underwriters Laboratories Inc. to US and Canadian Standards, File No. E28476



AMP power series connectors provide a durable, quick connect/disconnect means to transmit “power” levels of current and voltage (15-275 A, 600 V AC/DC).

This product family is primarily comprised of single-pole and 2-pole (battery) connector housings, crimp snap-in contacts, and accessories. Housings are offered in various colors. Two-pole housings have different polarization configurations; with the exception of black housings, each color identifies a different keying configuration. In general, only like color housings will mate. Contacts are either cold-headed or stamped and formed, depending upon the connector series.

AMP power series connectors are divided into eight series, based on approximate current-carrying capability.

Applications

AC/DC power supplies and charging systems, rechargeable batteries, material handling equipment (e.g. forklift trucks), electric vehicles (e.g., golf carts, sweepers, wheelchairs), office furniture/panels, amateur emergency radios, and industrial equipment.

AMP Power Series Connectors (Continued)



AMP Power Series 15/30/45

Single-pole connector housings are stackable side-to-side and top-to-bottom. For example, Series 30 red and black housings joined side-to-side, are commonly used as standard power connectors for handheld, mobile, or base amateur radio equipment.

Modular housings can also be grouped into plug frames with or without latches, which mate with receptacle housings. Typically, these are used as quick disconnects for electrical power distribution in office furniture and panels.



AMP Power Series 50

Two-pole (battery) housings are available in bulk quantities or in kit form (i.e., 1 housing and 2 contacts). These high durability connectors are designed for repeated mating and unmating.



**AMP Power Series 50
Finger Probe Resistant (FPR)**

This new, 2-pole, FPR version helps prevent finger access, which allows it to be more safely used at elevated voltages and in user access areas.

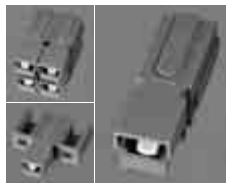

AMP Power Series 75

Single-pole, stackable housings, in locking and non-locking versions, are available in a variety of colors. Housings accept stamped and formed or cold-headed contacts. Bulk quantities and connector kits (1 housing and

1 contact) can be ordered. Accessories include: mounting wings for through-panel or surface mounting and mounting clamp sets for ganging housings.



AMP Power Series 120

This Series includes both single- and 2-pole (battery) versions. Single-pole housings with molded-in dovetails allow stacking. Housing retaining pins provide more vibration

protection. Two-pole housings have slots designed to accept mounting clamp sets for easier panel mounting.



AMP Power Series 175

Two-pole (battery) housings accept cold-headed contacts (4-1/0 AWG). Basically, these connectors offer the same features as the two-pole Series 50 connectors.



AMP Power Series 180

These stackable, single-pole connectors accept cold-headed contacts (4-1/0 AWG). Most features are similar to the smaller, single-pole, Series 120 connectors.



AMP Power Series 350

Rugged, 2-pole housings accept only loose piece, cold-headed contacts (1/0-300 MCM). Rated at 275 A, these connectors have been tested up to 275 A, with 4/0 AWG wire.

Selection Guide

Series	Housing Type	Stackable Housing	Current Max. (A)	Voltage, Max. (V, AC or DC)	Cold-headed Contact (AWG)	Stamped & Formed Contact (AWG)	Housing Colors	Approvals
15	Single-Pole	Yes	15	600	—	16-20	Blue, Black, White, Red Green, Yellow, Orange, Gray	UL File No. E28476
30	Single-Pole	Yes	30	600	—	12-16	Blue, Black, White, Red Green, Yellow, Orange, Gray	UL File No. E28476
45	Single-Pole	Yes	40*	600	—	10-14	Blue, Black, White, Red Green, Yellow, Orange, Gray	UL File No. E28476
50	2-Pole	No	50	600	6, 8, 10-12	6-10,10-12	Red, Gray, Blue, Black, Yellow	UL File No. E28476
75	Single-Pole	Yes	75	600	6, 8,10-12	6-10,10-12	Blue, Black, White, Green, Red (Single-Pole)	UL File No. E28476
120	Single-Pole	Yes	120	600	2, 4, 6	—	Blue, Black, White, Green, Red (Single-Pole)	UL File No. E28476
120	2-Pole	No	120	600	2, 4, 6	—	Blue, Gray (2-Pole)	UL File No. E28476
175	2-Pole	No	175	600	1/0, 1, 2, 4	—	Blue, Gray, Orange, Yellow, Red	UL File No. E28476
180	Single-Pole	Yes	180	600	1/0, 1, 2, 4	—	Blue, Black, White, Green, Red	UL File No. E28476
350	2-Pole	No	275**	600	1/0, 2/0, 3/0, 4/0, 300 MCM	—	Blue, Green, Red, Yellow, Orange, Gray	UL File No. E28476

*Performance equivalent to competition **Tested to 275 Amps with 4/0 AWG wire

AMP Power Series 15/30/45 Connectors (Single-Pole)

Cable Mounted Products

Product Facts

- Color-coded UL 94V-0 housings: blue, black, white, green, red, yellow, orange and gray
- Genderless housings reduce inventory
- 3 contact offerings available: Series 15, 30 and 45
- Built-in interlocking features (dovetails) allow stacking
- Series 15/30/45, single-pole connectors designed to meet Amateur Radio Emergency Service (ARES)/Radio Amateur Civil Emergency Service (RACES) Standard Power Connector requirements
- Plug frames (with or without latches) and receptacle housings accept stacked single-pole housings (2 to 8 poles)
- File No. E28476 

Material and Finish

- Housing**—Polycarbonate, UL 94V-0
- Retaining Spring**—Stainless Steel
- Contacts**—Copper with silver or tin plating
- Mounting Wings & Spacers**—Polycarbonate, UL 94V-0
- Retaining Pins**—Stainless steel

Electrical Characteristics

- Current Carrying Capability**—
40 A w/10 AWG wire (Series 45)
30 A w/12 AWG wire (Series 30)
20 A w/16 AWG wire (Series 15)
- Operating Voltage**—600 V, AC or DC
- Dielectric Withstanding Voltage**—2200 VDC
- Average Initial Contact Resistance**—525 micro-ohms

Mechanical Characteristics

- Contact Retention**—25 lbs. [111.2 N]
- Average Mating/Unmating Force**—4.7 [20.9 N]
- Max. Wire Insulation Diameter**—175 [18.16]
- Wire Size Range**—10-20 AWG [5-0.5 mm²]

Related Product Data

Accessories—page 151

Single-Pole Housing

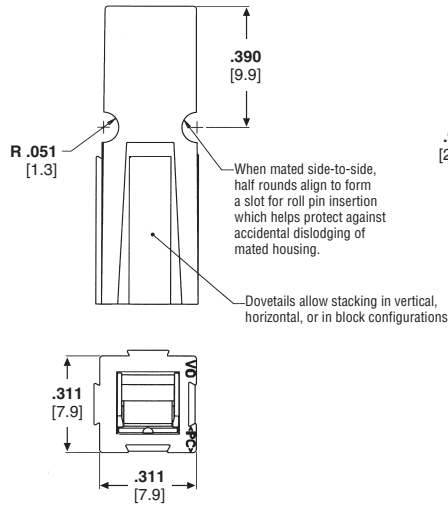

Stamped and Formed Contact (Strip)

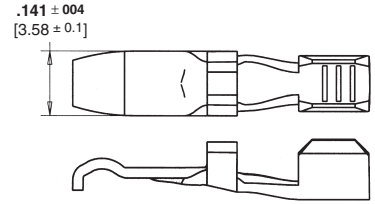

Closed Barrel Contact (Loose Piece)

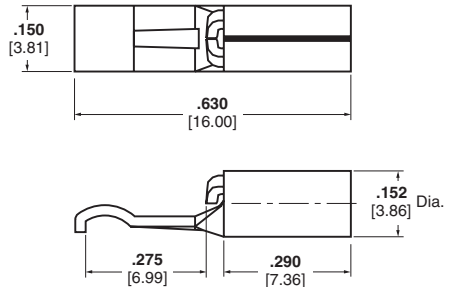

AMP Power Series 15

Housing ¹		Contact Part Number	
Color	Part Number	Strip Form (16, 18, 20 AWG)	Loose Piece (16-20 AWG)
Blue	1445957-1		
Black	1445957-2		
White	1445957-3		
Green	1445957-4	1604113-1 (silver) ²	1744042-1
Red	1445957-5	1604113-2 (tin) ²	
Yellow	1445957-6		
Orange	1445957-7		
Gray	1445957-8		

AMP Power Series 30

Housing ¹		Contact Part Number	
Color	Part Number	Strip Form (12, 14, 16 AWG)	Loose Piece (12-16 AWG)
Blue	1445957-1		
Black	1445957-2		
White	1445957-3		
Green	1445957-4	1604112-1 (silver) ³	1744041-1 Dimensions shown above.
Red	1445957-5	1604112-2 (tin) ³	
Yellow	1445957-6		
Orange	1445957-7		
Gray	1445957-8		

AMP Power Series 45

Housing ¹		Contact Part Number	
Color	Part Number	Strip Form (10, 12, 14 AWG)	
Blue	1445957-1		
Black	1445957-2		
White	1445957-3		
Green	1445957-4	1445962-1 (silver) ⁴	
Red	1445957-5	1445962-2 (tin) ⁴	
Yellow	1445957-6		
Orange	1445957-7		
Gray	1445957-8		

¹ Housings are bulk packaged.

² Use Applicator Part No. 1385450-3

³ Use Applicator Part No. 1385468-3

⁴ Use Applicator Part No. 1385469-3

Note: Tyco Electronics does NOT recommend intermating connectors with different contact platings.

Note: All part numbers are RoHS compliant.

AMP Power Series 50 Connectors (2-Pole Battery)

Product Facts

- **Color-coded UL 94V-0 housings: gray, red, blue, yellow and black; other colors available upon request**
Note: Black color housing has the same mechanical key as the gray housing
- **Mechanical keys help prevent two different voltage color-coded housings from mating**
- **Polarity (+ and -) molded into housings**
- **Genderless housings reduce inventory**
- **Cold-headed contact wire range: 6, 8, 10-12 AWG (Taped version of the cold-headed contacts available.)**
- **File No. E28476 c us**

Material and Finish

Housing—Polycarbonate, UL 94V-0
Retaining Spring—Stainless Steel
Contacts—Copper with silver plating
Reducing Bushings—Copper with silver plating

Electrical Characteristics

Current Carrying Capability—50 Amps per circuit w/6 AWG wire
Max. Operating Voltage—600 V, AC or DC
Dielectric Withstanding Voltage—2200 VDC
Average Initial Contact Resistance—200 micro-ohms

Mechanical Characteristics

Contact Retention—50 lbs. [222.4 N]
Average Mating/Unmating Force—15 lbs. [66.7 N]
Max. Wire Insulation Diameter—.44 [11.18]
Wire Size Range—6-12 AWG (also 6-16 AWG w/Reducing Bushings)

Related Product Data

Accessories—page 151

2-Pole Housing

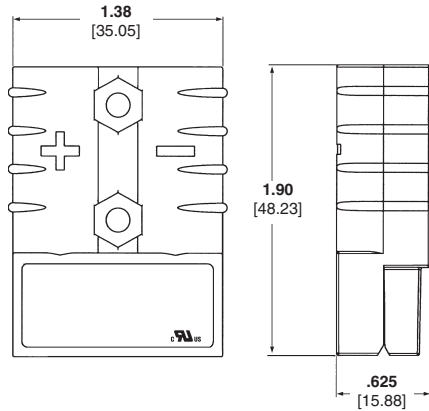

Cold-headed Contact

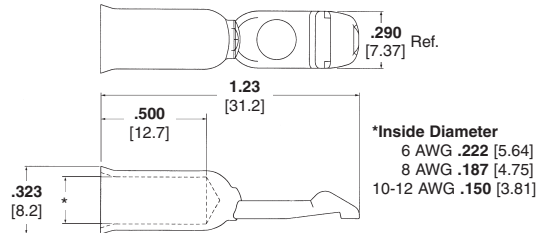

Stamped and Formed Contact (on Reel)

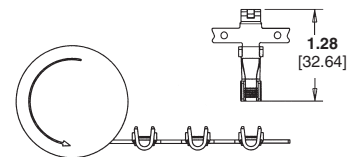

AMP Power Series 50 (2-Pole)

Housing ^{2,3}		Contact ²		Connector Kit Part Number ¹
Color	Part Number	Wire Size	Part Number	
Red	647845-3	6 AWG	647877-1	647892-3
		10-12 AWG	647879-1	647893-3
Gray	647845-4	6 AWG	647877-1	647892-4
		10-12 AWG	647879-1	647893-4
Blue	647845-5	6 AWG	647877-1	647892-5
		10-12 AWG	647879-1	647893-5
Black ⁴	647845-7	6 AWG	647877-1	647892-7
		10-12 AWG	647879-1	647893-7
Yellow	647845-8	6 AWG	647877-1	647892-8
		10-12 AWG	647879-1	647893-8
Cold-headed Contact		8 AWG	647878-1	—
⁵ Stamped and Formed contacts, on Reel		6-10 AWG	1604433-17	
⁶ Stamped and Formed contacts, on Reel		10-12 AWG	1604433-27	

- 1 1 Housing and 2 contacts.
- 2 Housings and contacts are bulk packaged.
- 3 Mechanical keys molded in housings generally will engage only with housings of same color.
- 4 Black color housing has the same mechanical key as the gray housing.
- 5 Use Heavy Duty Mini-Applicator (HDM) for 6 to 8 AWG - Part Number 1385663-2 (Use with AMP-O-ELECTRIC Model K Terminator)
- 6 Use Heavy Duty Mini-Applicator (HDM) for 10 to 12 AWG - Part Number 1385664-2 (Use with AMP-O-ELECTRIC Model K Terminator)
- 7 Use Power Lock Machine Part Number 68296-1

Voltage Key Color Chart

Housing Color	Voltage
Yellow	12V
Red	24V
Gray	36V
Blue	48V
Black	80V

Color code given for various voltages is only a suggestion, other codes and keys available upon request.

Note: All part numbers are RoHS compliant.

AMP Power Series 50 FPR (Finger Probe Resistant) Connectors

Cable Mounted Products

Product Facts

- Complies with UL 60950 finger probe requirements
- Utilizes AMP Power Series 50 contacts
- Brown and white housing colors available (other colors possible)
- Two keying configurations available (up to 6 keying configurations possible)
- File No. E28476 

Material and Finish

Housing—Polycarbonate, UL 94V-0
Retaining Spring—Stainless Steel
Contacts—Copper
Reducing Bushings—Copper with silver plating

Electrical Characteristics

Current Capability—50 A max.
Voltage Rating—600 V, AC or DC
Dielectric Withstanding Voltage—2200 VDC

Mechanical Characteristics

Meets UL finger probe as outlined in UL 60950
Contact Retention—50 lbs. [222.4 N]
Wire Size—6-12 AWG [15-3 mm²]
Max. Wire Insulation Diameter—.44 [11.18]

Related Product Data

Accessories—page 151

Applications

- Uninterruptible Power Supplies
- Power Supplies
- Battery Banks

2-Pole Housing



Cold-headed Contact



Stamped and Formed Contact (on Reel)



AMP Power Series 50 FPR (2-Pole)

Housing ^{1,2}		Wire Size	Contact Part Number ¹			
Color	Part Number		Cold-headed ⁵		Stamped and Formed/Strip ^{3,4,6}	
			Loose Piece	On Tape	On Reel	
Brown	1604342-1	6 AWG	647877-1	647754-1	6-10 AWG	1604433-16
		8 AWG	647878-1	647755-1		
White	1604342-2	10-12 AWG	647879-1	647756-1	10-12 AWG	1604433-26

¹ Housings and contacts are bulk packaged.
² Mechanical keys molded in housings will engage only with housings of same color.
³ Use Heavy Duty Mini-Applicator (HDM) for 6 to 8 AWG - Part Number 1385663-2 (Use with AMP-O-LECTRIC Model K Terminator)
⁴ Use Heavy Duty Mini-Applicator (HDM) for 10 to 12 AWG - Part Number 1385664-2 (Use with AMP-O-LECTRIC Model K Terminator)
⁵ Hand Tool for Cold-headed Contact - Part Number 1526955-1
 Taped version can be terminated using the AMP-TAPETRONIC Machine
⁶ Use Power Lock Machine Part Number 68296-1

Note: All part numbers are RoHS compliant.

AMP Power Series 75 Connectors (Single-Pole)

Product Facts

- Color-coded UL 94V-0 housings: blue, black, white, green and red
- Genderless housings reduce inventory
- Cold-headed contact wire range: 6, 8, 10-12 AWG
- Stamped and formed contacts available:
6-8 AWG Part Number 1604433-1 (strip);
10-12 AWG Part Number 1604433-2 (strip)
- File No. E28476 

Material and Finish

Housing—Polycarbonate, UL 94V-0
Retaining Spring—Stainless Steel
Contacts—Copper with silver plating
Reducing Bushings—Copper with silver plating
Mounting Wings—Polycarbonate, UL 94V-0
Retaining Pins—Stainless steel

Electrical Characteristics

Current Carrying Capability (with 6 AWG)—Configuration:
 Single-Pole 75 A
 1x2 Stacked 62 A
 2x2 Stacked 60 A
 1x3 Stacked 58 A
 2x3 Stacked 52 A
Operating Voltage—600 V, AC or DC

Dielectric Withstanding Voltage—2200 VDC

Average Initial Contact Resistance—200 micro-ohms

Mechanical Characteristics

Contact Retention—50 lbs. [222.4 N]

Average Mating/Unmating Force—15 lbs. [66.7 N]

Max. Wire Insulation Diameter—.44 [11.18]

Wire Size Range—6-12 AWG [15-3 mm²]

Related Product Data

Accessories—page 151

Application Tooling—page 153

Housing without Locking Feature

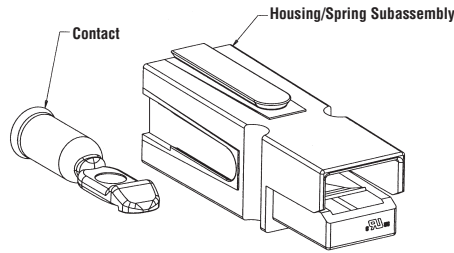

Housing with Locking Feature

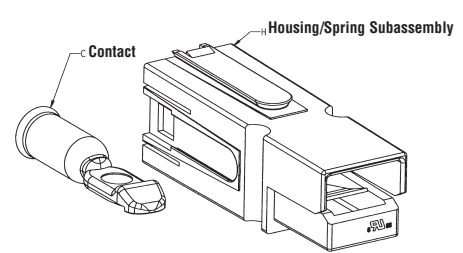

Cold-headed Contact

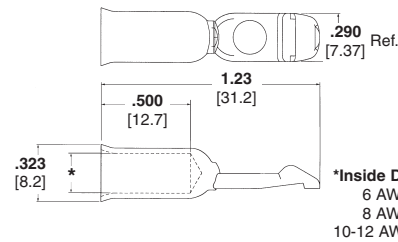

Stamped and Formed Contact (on Reel)

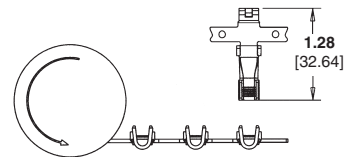

AMP Power Series 75 (Single-Pole)

Color	Housing ² Part Number	Cold-headed Contact ²		Connector Kit Part Number ¹
		Wire Size	Part Number	
Non-Locking Version				
Blue	1445715-1	6 AWG	647877-1	1445716-1
Black	1445715-2	6 AWG	647877-1	1445716-2
White	1445715-3	6 AWG	647877-1	1445716-3
Green	1445715-4	6 AWG	647877-1	1445716-4
Red	1445715-5	6 AWG	647877-1	1445716-5
Locking Version				
Blue	1445715-6	6 AWG	647877-1	1445716-6
Black	1445715-7	6 AWG	647877-1	1445716-7
White	1445715-8	6 AWG	647877-1	1445716-8
Green	1445715-9	6 AWG	647877-1	1445716-9
Red	1-1445715-0	6 AWG	647877-1	1-1445716-0

*Samples available on loose housing and contacts only.

Contacts

Description	Wire Size	Part Number	Die Set Part Number ³	Applicator Part No. for AMP-O-ELECTRIC Model K Terminator
Cold-headed (Loose Piece) ⁴	6 AWG	647877-1	—	—
	8 AWG	647878-1	—	—
	10-12 AWG	647879-1	—	—
Cold-headed (Tape) ^{3, 4}	6 AWG	647754-1	68344-1	—
	8 AWG	647755-1	68344-1	—
	10-12 AWG	647756-1	68313-1	—
Stamped and Formed (Strip)	6-8 AWG	1604433-1	—	1385664-2
	10-12 AWG	1604433-2	—	1385663-2

¹ 1 housing and 1 contact

² Housings and contacts are bulk packaged.

³ Taped version can be terminated using the AMP-TAPETRONIC machine Part Number 68250-1.

⁴ Use hand tool Part Number 1526955-1 for Cold-headed contacts

Note: All part numbers are RoHS compliant.

AMP Power Series 120 Connectors (Single-Pole)



Product Facts

- Color-coded modular housings: blue, black, white, green and red
- Genderless housings reduce inventory
- Cold-headed contact wire range: 2, 4, and 6 AWG
- Built-in interlocking features (dovetails) allow stacking and wire routing
- Self-wiping contacts increase product life and improve conductivity
- Integral stainless steel locking spring in housing for contact retention
- Rugged design
- File No. E28476

Material and Finish

- Housing**—Polycarbonate, UL 94V-0
- Retaining Spring**—Stainless Steel
- Contacts**—Copper with silver plating
- Reducing Bushings**—Copper with silver plating
- Mounting Clamp Sets**—Aluminum

Electrical Characteristics

- Current Carrying Capability**—
Single-Pole—120 A
2x1 Stacked Array—115 A
2x2 Stacked Array—115 A
- Voltage Rating**—600 V
(both AC and DC)
- Dielectric Withstanding Voltage**—
2200 VDC
- Average Initial Contact Resistance**—136 micro-ohms

Mechanical Characteristics

- Contact Retention**—100 lbs.
[444.8 N]
- Average Mating/Unmating Force**—8 lbs. [35.6 N]
- Temperature Rating**—-4°F to
221°F [-20°C to 105°C]
- Max. Wire Insulation Diameter**—
.6 [15.24]
- Wire Size Range**—2-6 AWG

Single-Pole Housing



Cold-headed Contact

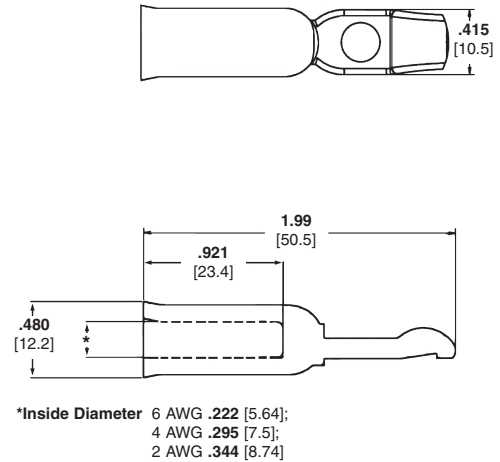

AMP Power Series 120 (Single-Pole)

Housing		Contact		Connector Kit Part Number ¹
Color	Part Number	Wire Size	Part Number	
Blue	1604001-1	2 AWG	1445995-1	1604002-1
Black	1604001-2	2 AWG	1445995-1	1604002-2
White	1604001-3	2 AWG	1445995-1	1604002-3
Green	1604001-4	2 AWG	1445995-1	1604002-4
Red	1604001-5	2 AWG	1445995-1	1604002-5
—	—	4 AWG	1445996-1	—
—	—	6 AWG	1445997-1	—

¹ 1 Housing and 1 contact.

Related Product Data

- Accessories**—page 152
- Application Tooling**—page 153
- Technical Documents**—page 154

Note: All part numbers are RoHS compliant.

AMP Power Series 120 Connectors (2-Pole Battery)



Product Facts

- Color-coded UL 94V-0 housings: gray and blue
- Keying feature helps prevent two different voltage color-coded housings from mating
- Genderless housings reduce inventory
- Contact wire range: 2, 4, 6 AWG
- Molded-in panel-mount grooves
- Integral stainless steel locking spring in housing for contact retention
- Rugged design
- File No. E28476 

Material and Finish

- Housing**—Polycarbonate, UL 94V-0
- Retaining Spring**—Stainless Steel
- Contacts**—Copper with silver plating
- Reducing Bushings**—Copper with silver plating

Electrical Characteristics

- Current Carrying Capability**—115 A with 2 AWG
- Voltage Rating**—600 V (both AC and DC)
- Dielectric Withstanding Voltage**—2200 VDC
- Avg. Initial Contact Resistance**—136 micro-ohms

Mechanical Characteristics

- Contact Retention**—100 lbs. [444.8 N]
- Average Mating/Unmating Force**—18 lbs. [80.1 N]
- Temperature Rating**—-4°F to 221°F [-20°C to 105°C]
- Max. Wire Insulation Diameter**—.6 [15.24]
- Wire Size Range**—2-6 AWG

Related Product Data

- Accessories**—page 152
- Application Tooling**—page 153
- Technical Documents**—page 154

2-Pole Housing



Cold-headed Contact



AMP Power Series 120 (2-Pole)

Housing ^{2,3}		Contact ²		Connector Kit Part Number ¹
Color	Part Number	Wire Size	Part Number	
Gray	1445994-1	2 AWG	1445995-1	1445998-1
Blue	1445994-2	2 AWG	1445995-1	1445998-2
Gray	1445994-1	4 AWG	1445996-1	1445999-1
Blue	1445994-2	4 AWG	1445996-1	1445999-2
Gray	1445994-1	6 AWG	1445997-1	1446000-1
Blue	1445994-2	6 AWG	1445997-1	1446000-2

¹ 1 Housing and 2 contacts.
² Housings and contacts are bulk packaged.
³ Mechanical keys molded in connectors will engage only with connectors of same color.

Voltage Key Color Chart

Housing ^{2,3} Color	Voltage
Gray	36 V
Blue	48 V

Color code given for various voltages is only a suggestion, other codes and keys available upon request.

Note: All part numbers are RoHS compliant.

AMP Power Series 175 Connectors (2-Pole Battery)

Product Facts

- Color-coded UL 94V-0 housings: yellow, orange, red, gray, blue, and black
- Keying feature helps prevent two different voltage color-coded housings from mating
- Genderless housings reduce inventory
- Contact wire range: 1/0, 1, 2, 4 AWG
- Integral stainless steel locking spring in housing for contact retention
- Reducing bushings down to 10 gauge
- File No. E28476 **us**

2-Pole Housing

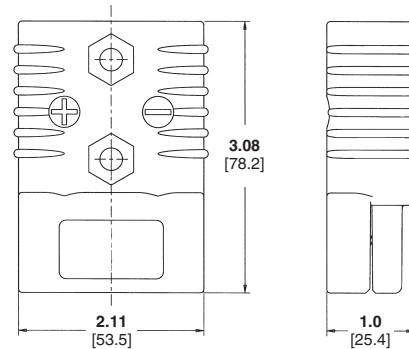

Cold-headed Contact

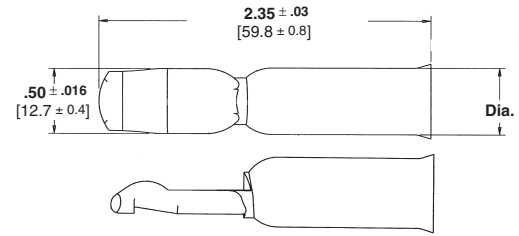

Inside Diameter .516±.005 [13.1±0.13] for 1/0 AWG
.512±.005 [13.0±0.13] for 1 AWG,
2 AWG, and 4 AWG

Cable Mounted Products

Material and Finish

Housing—Polycarbonate, UL 94V-0
Retaining Spring—Stainless Steel
Contacts—Copper with silver plating
Reducing Bushings—Copper with silver plating

Electrical Characteristics

Current Carrying Capability—
175 Amp @ 80.42°F [26.9°C] T-Rise
with 1/0 AWG wire

Voltage Rating—600 V (both AC
and DC)

Dielectric Withstanding Voltage—
2200 VDC

Avg. Initial Contact Resistance—
100 micro-ohms

Mechanical Characteristics

Average Mating/Unmating

Force—25 lbs. [111.21 N]

Max. Wire Insulation Diameter—
.750 [19.05]

Wire Size Range—1/0, 1, 2, 4 AWG
[53, 40, 35, 21 mm²]

Contact Retention—300 lbs.
[1,334.47 N]

Temperature Rating—-4°F to
221°F [-20°C to 105°C]

Related Product Data

Accessories—page 152

Application Tooling—page 153

Technical Documents—page 154

AMP Power Series 175 (2-Pole)

Housing		Connector Kit Part Numbers ^{1, 2}			
Color	Part Number	4 AWG	2 AWG	1 AWG	1/0 AWG
Yellow	1604037-1	1604044-1	1604043-1	1604045-1	1604042-1
Orange	1604037-2	1604044-2	1604043-2	1604045-2	1604042-2
Red	1604037-3	1604044-3	1604043-3	1604045-3	1604042-3
Gray	1604037-4	1604044-4	1604043-4	1604045-4	1604042-4
Blue	1604037-5	1604044-5	1604043-5	1604045-5	1604042-5
Black ³	1604037-6	1604044-6	1604043-6	1604045-6	1604042-6

¹ 1 Housing and 2 contacts.

² Housings and contacts are bulk packaged.

³ Black housing mates with any other housing.

Contacts (Cold-headed)

Wire Size	Part Number
4 AWG	1604040-1
2 AWG	1604039-1
1 AWG	1604041-1
1/0 AWG	1604038-1

Voltage Key Color Chart

Housing Color	Voltage
Yellow	12 V
Orange	18 V
Red	24 V
Gray	36 V
Blue	48 V
Black	80 V

Color code given for various voltages is only a suggestion, other codes and keys available upon request.

Note: All part numbers are RoHS compliant.

AMP Power Series 180 Connectors (Single-Pole)

Product Facts

- Color-coded modular housings: blue, black, white, red and green
- Genderless housings reduce inventory
- Contact wire range: 1/0, 1, 2, 4 AWG
- Integral stainless steel locking spring in housing for contact retention
- Built-in interlocking features (dovetails) allow stacking and wire routing
- Reducing bushings down to 10 gauge
- File No. E28476 c  us

Single-Pole Housing



Cold-headed Contact



Material and Finish

- Housing**—Polycarbonate, UL 94V-0
Retaining Spring—Stainless Steel
Contacts—Copper with silver plating
Mounting Clamp Sets—Aluminum
Reducing Bushings—Copper with silver plating

Electrical Characteristics

- Current Carrying Capability**—
 (1/0 AWG Wire)
 1 x 1 — 180 A, 84.9°F [29.4°C] T-Rise
 2 x 1 — 165 A, 78.3°F [25.7°C] T-Rise
 2 x 2 — 150 A, 76.6°F [24.8°C] T-Rise
- Voltage Rating**—600 V (both AC and DC)
- Dielectric Withstanding Voltage**—
 2200 VDC
- Avg. Initial Contact Resistance**—
 100 micro-ohms

Mechanical Characteristics

- Average Mating/Unmating Force**—20 lb. [89 N]
Max. Wire Insulation Diameter—
 .900 [22.86]
Wire Size Range—1/0, 1, 2, 4 AWG
 [53, 40, 35, 21 mm²]
Contact Retention—170 lb. [756 N]
Temperature Rating—-4°F to
 221°F [-20°C to 105°C]

Related Product Data

- Accessories**—page 152
Application Tooling—page 153
Technical Documents—page 154

AMP Power Series 180 (Single-Pole)

Housing		Connector Kit Part Numbers ^{1,2}			
Color	Part Number	4 AWG	2 AWG	1 AWG	1/0 AWG
Blue	1604062-1	1604395-1	1604396-1	1604397-1	1604398-1
Black	1604062-2	1604395-2	1604396-2	1604397-2	1604398-2
White	1604062-3	1604395-3	1604396-3	1604397-3	1604398-3
Red	1604062-4	1604395-4	1604396-4	1604397-4	1604398-4
Green	1604062-5	1604395-5	1604396-5	1604397-5	1604398-5

¹ 1 Housing and 1 contact.
² Housings and contacts are bulk packaged.

Contacts (Cold-headed)

Wire Size	Part Number
4 AWG	1604040-1
2 AWG	1604039-1
1 AWG	1604041-1
1/0 AWG	1604038-1

Note: All part numbers are RoHS compliant.

AMP Power Series 350 Connectors (2-Pole Battery)

Cable Mounted Products

Product Facts

- Color-coded UL 94V-0 housings: yellow, orange, red, gray, blue, and green
- Keying feature helps prevent two different voltage color-coded housings from mating
- Genderless housings reduce inventory
- Contact wire range: 1/0, 2/0, 3/0, 4/0, 300 MCM
- Replaceable contacts
- Integral stainless steel locking spring in housing for contact retention
- File No. E28476 

Material and Finish

Housing—Polycarbonate, UL 94V-0
Retaining Spring—Stainless Steel
Contacts—Copper with silver plating
Reducing Bushings—Copper with silver plating

Electrical Characteristics

Current Carrying Capability—275 Amp @ 83.3°F [28.5°C] T-Rise with 4/0 AWG wire
Voltage Rating—600 V, AC or DC
Dielectric Withstanding Voltage—2200 VDC
Average Initial Contact Resistance—50 micro-ohms

Mechanical Characteristics

Contact Retention—500 lbs. [2224.1 N]
Average Mating/Unmating Force—30 lbs. [133.5 N]
Max. Wire Insulation Diameter—1.10 [27.94]
Temperature Rating—-4°F to 221°F [-20°C to 105°C]
Wire Size Range—1/0, 2/0, 3/0, 4/0, 300 MCM [53, 67, 85, 107, 152 mm²]

Related Product Data

Accessories—page 152
Application Tooling—page 153
Technical Documents—page 154
Reducing Bushing—(1/0 to 2/0 AWG)
Part No. 1604121-6
Cable Clamp—Part No. 647688-1

2-Pole Housing

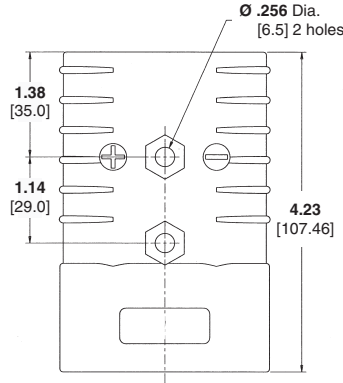

Cold-headed Contact

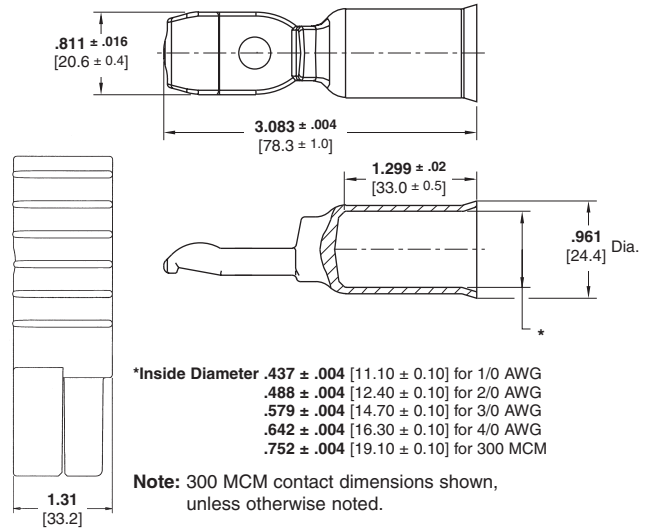

AMP Power Series 350 (2-Pole)

Housing		Connector Kit Part Numbers ^{1,2}				
Color	Part Number	1/0 AWG	2/0 AWG	3/0 AWG	4/0 AWG	300 MCM
Yellow	1604050-1	1604060-1	1604059-1	1604058-1	1604057-1	1604056-1
Orange	1604050-2	1604060-2	1604059-2	1604058-2	1604057-2	1604056-2
Red	1604050-3	1604060-3	1604059-3	1604058-3	1604057-3	1604056-3
Gray	1604050-4	1604060-4	1604059-4	1604058-4	1604057-4	1604056-4
Blue	1604050-5	1604060-5	1604059-5	1604058-5	1604057-5	1604056-5
Green	1604050-6	1604060-6	1604059-6	1604058-6	1604057-6	1604056-6

¹ 1 Housing and 2 contacts.
² Housings and contacts are bulk packaged.

Contacts (Cold-headed)

Wire Size	Part Number
1/0 AWG	1604055-1
2/0 AWG	1604054-1
3/0 AWG	1604053-1
4/0 AWG	1604052-1
300 MCM	1604051-1

Voltage Key Color Chart

Housing Color	Voltage
Yellow	12V
Orange	18V
Red	24V
Gray	36V
Blue	48V
Green	72V

Color code given for various voltages is only a suggestion, other codes and keys available upon request.

Note: All part numbers are RoHS compliant.

AMP Power Series Accessories

AMP Power Series 15/30/45 Mounting Wings

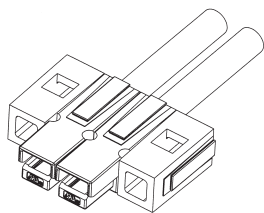

AMP Power Series 15/30/45 Accessories

Part Number	Description
Mounting Wings	
1445960-1	Red, UL 94V-0
Spacers	
1445959-1	Red, UL 94V-0, Short
1445959-2	Red, UL 94V-0, Long
Retaining Pins for use with 15 A/30 A/45 A	
1445886-4	.25 [6.35] length
1445886-5	.44 [11.18] length

Part Number	Description
Hardware Kits (Cable clamp, screws & retaining pins)	
647747-3	4 pole
647747-2	6 pole
647747-1	8 pole

AMP Power Series 15/30/45 Hardware Kits

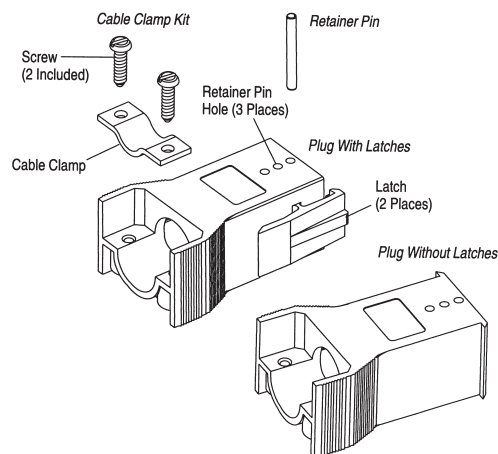

AMP Power Series 50 Accessories

Part Number	Description
1744077-1	Dust Cover, Black
1445762-1	Reducing Bushing — 6 to 8 AWG
647840-1	Reducing Bushing — 6 to 10-12 AWG
1445763-1	Reducing Bushing — 6 to 14-16 AWG

Please contact Product Engineering or Product Management for availability. (permits use of smaller wires with 6 AWG contact Part Number 647877-1)

AMP Power Series 75 Accessories

Part Number	Description
Mounting Wings	
1445729-1	Blue, oval mounting hole
1445729-2	Blue, round mounting hole
Retaining Pins for use with 75 A/120 A/180 A	
1445886-1	75 A/120 A/180 A hsgs, 1 high block
1445886-2	75 A/120 A/180 A hsgs, 2 high block
Reducing Bushings for Series 50 A and 75 A	
1445762-1	6 to 8 AWG
647840-1	6 to 10-12 AWG
1445763-1	6 to 14-16 AWG

Mounting clamp set part numbers available.

Note: All part numbers are RoHS compliant.

AMP Power Series Accessories (Continued)

**AMP Power Series 120
Panel Mounting Clamp**

AMP Power Series 120 Accessories

Part Number	Type	Description
Retaining Pins for use with 75A/120A/180A		
1445886-1	Single-Pole	1 high block
1445886-2	Single-Pole	2 high block
Reducing Bushings		
1604072-3	Single/2-Pole	2 to 4 AWG
1604072-2	Single/2-Pole	2 to 6 AWG
1604072-1	Single/2-Pole	2 to 8 AWG
Mounting Clamp Sets		
647721-1	Single-Pole	2- & 4- pole configuration
647722-1	Single-Pole	3-pole configuration
Panel Mounting Clamp		
1744090-1	2-Pole	—

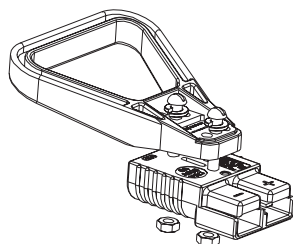
**AMP Power Series 175 & 350
Handle Kit**

AMP Power Series 175, 180 & 350 Accessories

Part Number	Type	Description
Reducing Bushings		
1604121-1	175/180	10 to 1/0 AWG
1604121-2	175/180	6 to 1/0 AWG
1604121-5	175/180	4 to 1/0 AWG
1604121-4	175/180	2 to 1/0 AWG
1604121-3	175/180	1 to 1/0 AWG
1604121-6	350	1/0 to 2/0 AWG
Handle Kit		
647737-1	175 2-Pole	Red
647737-2	175 2-Pole	Gray
1-647737-1	350 2-Pole	Red
1-647737-2	350 2-Pole	Gray

**AMP Power Series 175
Dust Cover Assembly**

AMP Power Series 175 & 180 Accessories

Part Number	Type	Description
Cable Clamps		
647720-1	180	2 pole version
647719-1	180	3 pole version
Dust Cover		
647691-1	175	Dust Cover Assembly (Shown)
647692-1	175	Dust Cover Housing

Note: All part numbers are RoHS compliant.

AMP Power Series Tooling

**Power Applicator
Part Number 68296-1
(Customer Manual 409-2661)**



The semiautomatic power applicator is designed to produce a carefully controlled uniform pressure crimp while providing a high rate of production. The applicator features matching dies that fully bottom at the completion of the crimp to provide proper crimp height. The one die set is fully adjustable to provide the full range of crimp heights for all wire sizes.

**500 MCM Heavy Duty
Cable Cutter
Part No. 605742-1 (408-4557)**



- Designed to cut aluminum or copper cable up to 500 MCM.
- Light weight tubular steel handles with hand grips
- 21" overall length

**Cable Insulation
Stripper/Slitter
Part No. 606700-1 (408-9688)**



- Used on single or multiple conductor cable up to 1.75" in diameter

**Hand Tools for Cold-Headed
Contacts and Heavy-Duty Lug
Terminals (Single-Indent Crimp)**



**Contact Extraction Tool
Part No. 68265-1 or standard
insulated screwdriver**

For AMP Power Series 50 and 75 Contacts			Tyco Electronics Crimp Tool Part No. 1526955-1 Includes Adapter		OR	American Electrical Terminal (AET) Crimp Tool Part No. T-406 Includes Adapter		Also For Heavy-Duty Lug Terminals	
Wire Size (AWG)	Strip Length	Part No.	Part Number	Marking	Part Number	Marking	Wire Size (AWG)	Strip Length	
6		647877-1	1527508-1	A	5992	A	6	7/16 [11.11]	
8	.475-.525 [12.06-13.33]	647878-1					4	1/2 [12.70]	
10-12		647879-1					1/0	11/16 [17.46]	
—	—	—	1527507-1	B	5991	B	2/0	11/16 [17.46]	
—	—	—	1527505-1	C	5989	C	2	9/16 [14.29]	
—	—	—	No Adapter	—	No Adapter	—	1	5/8 [15.87]	
—	—	—	—	—	—	—	3/0	3/4 [19.05]	
—	—	—	—	—	—	—	4/0	13/16 [20.64]	

**Pneumatic Tools for Cold-Headed Contacts
(Dual-Indent Crimp) and Heavy-Duty Lug Terminals**



AMP Power Series Contacts			PICO* Pneumatic Tools**					
Series	Wire Size (AWG)	Part No.	400 Series Power Unit		Die	Locator		Closure Dim.
			Preferred	Alternate		Preferred	Alternate	
50/50 FPR/75	6	647877-1	400-BEC	400-BHD	414DA-4583	4582-1	9616-1	.152 [3.86]
	8	647878-1			414DA-4583			.152 [3.86]
	10-12	647879-1			414DA-4582			.134 [3.40]
120	2	1445995-1	400-BEC	400-BHD	414DA-4580	4580-1	None	.200 [5.08]
	4	1445996-1						
	6	1445997-1						
50/50 FPR/75	6	647877-1	500-DEC	500-D	514DA-7033	7033-1	7034-1	.152 [3.86]
	8	647878-1			514DA-7033			.152 [3.86]
	10-12	647879-1			514DA-7034			.134 [3.40]
120	2	1445995-1	500-DEC	500-D	514DA-7035	7035-1	None	.200 [5.08]
	4	1445996-1						
	6	1445997-1						
175/180	1/0	1604038-1	500-DEC	500-D	514DA-10023	10034-1	None	.225 [5.72]
	2	1604039-1						
	4	1604040-1						
	1	1604041-1						
350	300 MCM	1604051-1	500-DEC	500-D	514DA-10027	10023-2	None	.475 [12.07]
	4/0	1604052-1			514DA-10026	10023-2		.400 [10.16]
	3/0	1604053-1			514DA-10025	10023-2		.360 [9.14]
	2/0	1604054-1			514DA-10024	10023-1		.325 [8.26]
	1/0	1604055-1			514DA-10023	10023-1		.225 [5.72]

* Pico Corporation, 444 Constitution Ave., Camarillo, CA 93012-8505; Tel: (805) 388-5510

** Pneumatic Tool consists of a power unit, die, and locator; it can be used as a portable hand tool, bench-mounted hand tool, or foot-controlled unit.

Note: All part numbers are RoHS compliant.

AMP Power Series Connectors (Continued)

Technical Documents

Various technical documents are available for your use:

Product Specifications describe technical performance characteristics and verification tests. They are intended for the Design, Component and Quality Engineer.

108-1349	AMPINNERGY WTB Connectors
108-1373	AMPINNERGY WTW Connectors
108-2104	AMP Power Series 50 Connectors
108-2149	AMP Power Series 15 Connectors
108-2150	AMP Power Series 30 Connectors
108-2151	AMP Power Series 45 Connectors
108-2152	AMP Power Series 75 Connectors
108-2153	AMP Power Series 120 Connectors
108-2154	AMP Power Series 175 Connectors
108-2155	AMP Power Series 180 Connectors
108-2156	AMP Power Series 350 Connectors

Application Specifications describe requirements for using the product in its intended application and/or crimping information. They are intended for the Packaging and Design Engineer and the Machine Setup Person.

114-6044	AMPINNERGY WTB Connectors
114-6051	AMPINNERGY WTW Connectors
114-13071	AMP Power Series 50 (Double-Pole) and 75 (Single Pole) Connector Assemblies
114-13107	AMP Power Series 120 (Single- and Double-Pole) Connector Assemblies
114-13118	AMP Power Series 175 (Double-Pole) and 180 (Single-Pole) Connector Assemblies
114-13119	AMP Power Series 350 (Double-Pole) Connector Assemblies
114-13127	AMP Power Series 15, 30 and 45 (Single-Pole) Connector Assemblies

Instruction Sheets provide instructions for assembling or applying the product. They are intended for the Manufacturing Assembler or Operator.

408-3198	Inspection of AMPINNERGY System Power Contacts
408-3236	Installation of AMPINNERGY WTB Connectors
408-3277	AMPINNERGY Wire-To-Wire Stackable Connectors
408-8636	AMP Power Series 50 Connector Assemblies
408-8868	AMP Power Series 175 and 350 Connector Assemblies with Cable Clamp Kits
408-4557	Heavy Duty Cable Cutter Hand Tool 605743-1
408-4559	Heavy Duty Cable Cutter Hand Tool 605744-1
408-4561	Heavy Duty Cable Cutter Hand Tool 6057469-1
408-8540	Crimp Tool 1526955-1
408-9688	Cable Stripper/Slitter Tool 606700-1
408-9816	Handling of Reeled Products

Test Summary

502-1136	50/75 Product Evaluation
502-1160	15/30/45 Product Evaluation
502-1166	120 Product Evaluation
502-1167	120 Competitive Evaluation
502-1172	AMP Power Series 175/180 Product Evaluation
502-1173	AMP Power Series 350 Product Evaluation
502-1189	15/30/45 Intermate
502-1206	15/30/45 Stamped and Formed Contact Evaluation

Customer Manual

409-5128	AMP-O-LECTRIC Model K Terminator Machine 1-471273-2
-----------------	-----------------------------------------------------

Note: All part numbers are RoHS compliant.

Domino Series Connectors

Hot-Plug High Current Modular Power Connectors

Key Features

- Modular construction
- Blind-mating
- High current CROWN BAND contacts
- Logic/Signal
- Locking system
- Uses ELCON drawer contacts

Typical Applications

- Power Supplies
- Telecommunications
- Automatic Test Equipment
- Computer Hardware
- Process Control
- Uninterruptible Power Systems
- All Domino products in this section are RoHS compliant



The ELCON Domino connector system is a modular high-current connector system consisting of interchangeable modules which can provide AC, DC, logic and signal, float mounting, and pin sequencing. All Domino modules incorporate CROWN BAND technologies, tried and tested under the most arduous conditions. The high current capabilities virtually eliminate the need for bussing or splitting current, with resulting space savings and economies.

The Domino connector system allows the user to configure a connector specific to an application, from off-the-shelf components. It can be purchased as separate modules and assembled by the user, but is more generally ordered as a

connector assembly using an assembly part number which Tyco Electronics assigns to a specific configuration. Consult Tyco Electronics for assistance in laying out a new connector. If required, Domino connector assembly is simple: once the locking rails are cut to size, the only tool required is a Phillips screwdriver for tightening the end-caps.

Most Domino contacts are the same as used in ELCON drawer connectors. Modules A through E and R are sold as housings with retention clips; the contacts are ordered separately. See page 80 for available contact options and plating information, page 67 for tooling. Modules K, L, and M are sold pre-loaded with contacts. Domino assemblies are shipped complete with contacts.

The Domino system is ideal for use with hot-pluggable power supplies of the type employed for load-sharing and/or redundant power for computer systems. Current interruption capability is standard in the L module and an available option in the A module.

The CROWN BAND contact is a small louvered cylindrical receptacle of beryllium copper. Manufactured on progressive dies to allow consistent, even insertion and withdrawal forces, its design helps ensure maximum surface contact area for minimum voltage drop and minimum heat generation. CROWN BAND contacts also provide excellent shock and vibration resistance.

Domino Series Connectors (Continued)

A Modules — 3 x #12 Power Contacts, Hot-Plug option available

Note: Supplied without contacts. Crimp insertable/removable, PCB insertable/non-removable

Specifications: Contact rating 35 Amps UL, 20 Amps CSA, 250V; Hot-plug 35 Amps UL, 30 Amps CSA, 120 V ac, 50 cycles; Fully loaded module nominal forces: insertion 9.2 lbs, extraction 5.5 lbs (Hot-plug insertion 11.5 lbs, extraction 6.4 lbs)

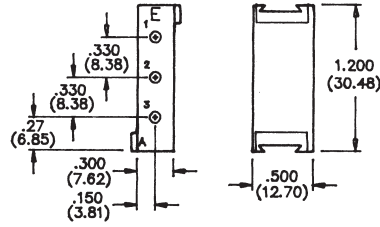

Pin Housing
(without contacts)
Part Number 1648461-1

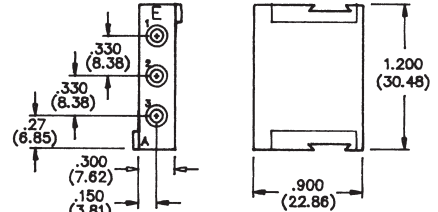

Socket Housing
(without contacts)
Part Number 1648466-1

B Modules — 2 x #8 Power Contacts

Note: Supplied without contacts. Crimp insertable/removable, PCB insertable/non-removable

Specifications: Contact rating 75 Amps UL, 40 Amps CSA, 250V; Fully loaded module nominal forces: insertion 6.7 lbs, extraction 3.9 lbs



Pin Housing
(without contacts)
Part Number 1648462-1

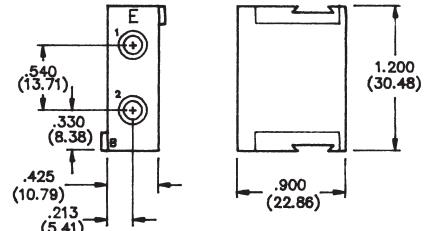

Socket Housing
(without contacts)
Part Number 1648467-1

C Modules — 20 x #20 Signal Contacts

Note: Supplied without contacts. Crimp insertable/removable, PCB insertable/non-removable

Specifications: Contact rating 5 Amps UL, 4 Amps CSA, 125V; Fully loaded module nominal forces: insertion 2.4 lbs, extraction 2.6 lbs



Pin Housing
(without contacts)
Part Number 1648463-1



Socket Housing
(without contacts)
Part Number 1648468-1

D Module — 5 x #16 Power Contacts

Note: Supplied without contacts. Crimp insertable/removable, PCB insertable/non-removable

Specifications: Contact rating 15 Amps UL, 10 Amps CSA, 125V; Fully loaded module nominal forces: insertion 18.6 lbs, extraction 13.0 lbs



Pin Housing
(without contacts)
Part Number 1648464-1

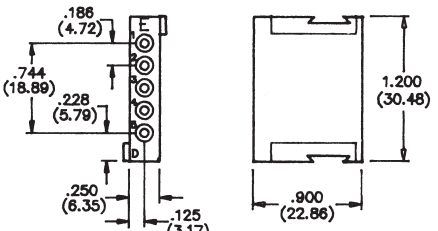

Socket Housing
(without contacts)
Part Number 1648469-1

Note: All part numbers are RoHS compliant.

Domino Series Connectors (Continued)

E Modules — 14 x #16 Power Contacts

Note: Supplied without contacts. Crimp insertable/removable, PCB insertable/non-removable

Specifications: Contact rating 15 Amps UL, 10 Amps CSA, 125V; Fully loaded module nominal forces: insertion 43.1 lbs, extraction 33.7 lbs



G Modules - Non-electrical Guide Module

Note: May be turned through 180 in the horizontal plane

Specifications: Guide pin type 303 Stainless Steel, passivated

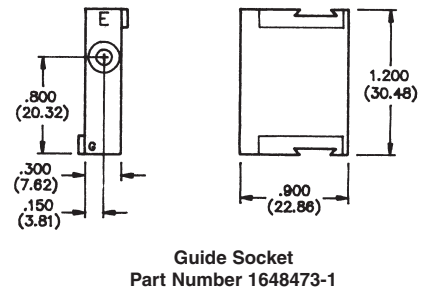
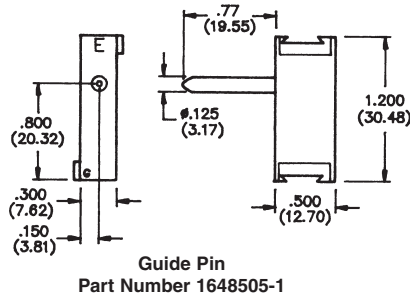

J Modules — Jackscrew Locking Module

Note: Select socket side to match desired orientation of T-handle in locked position

Specifications: Corrosion resistant Steel

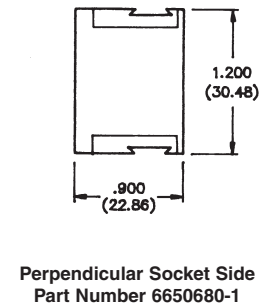
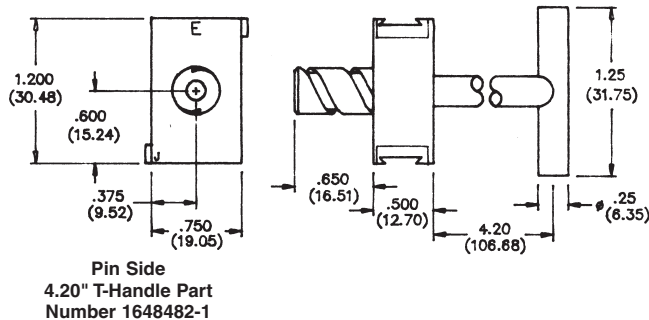

Note: All part numbers are RoHS compliant.

Domino Series Connectors (Continued)

K Modules — Electrically Active Ground/Guide Module

Note: May be turned through 180 in the horizontal plane. Use Crimp Tool PN 1766453-1

Specifications: Contact rating 40 Amps UL, 15 Amps CSA, 250V; Fully loaded module nominal forces: insertion 3.0 lbs, extraction 1.3 lbs



Guide Pin
10 AWG Crimp
Part Number 6648508-1



Guide Socket
10 AWG Crimp
Part Number 6648476-1

M Modules — Pre-installed Dual In-Line Crown Pin & Socket

Specifications: Contact rating 125 Amps UL/CSA, 250V; Fully loaded module nominal forces: insertion 14.9 lbs, extraction 9.8 lbs



Pin Module
Ext. Threaded
Part Number 6648499-1



Socket Module
Ext. Threaded
Part Number 6648454-1

Recommended torque value 40 lb.in (4.52 N.m)

R Modules — 2 x 1/4" Power Contacts

Note: Supplied without contacts; available contacts: Crimp insertable/removable, Ext. Threaded insertable/non-removable, consult Tyco Electronics for contact part numbers and available Double Crown option

Specifications: Contact rating 150 Amps UL, 110 Amps CSA, 250V; Fully loaded module nominal forces: insertion 9.4 lbs, extraction 6.0 lbs



Pin Module
(without contacts)
Part Number 6648515-1

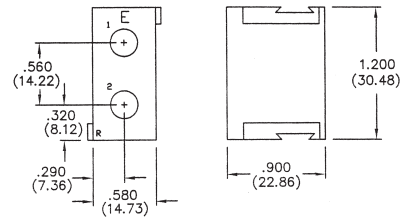

Socket Module
(without contacts)
Part Number 6648457-1

Spacer Module — Non-electrical

Note: any module may be ordered without contacts for use as spacers; consult sales engineer for options and part numbers.

Note: All part numbers are RoHS compliant.

Domino Series Connectors (Continued)

Domino Assembly
Mounting Accessories



Screw Part Number 1766829-1, Steel

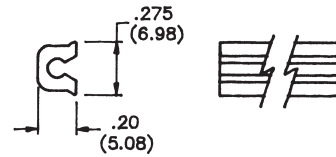

Locking Rail Part Number 1648990-1,
Aluminum alloy, gold anodized finish, 36" length.
Requires cutting to size.

Locking Rail (at 1' interval)
Part Number 1650469-1

End Caps — Zinc die cast, CRS hardware, trivalent chromate finish

End caps secure the modules when screwed into the locking rails providing rigid assembly and a means of mounting assembly to frames, bulkheads, etc. Float-mount styles correct for misalignment during mating. Any end cap may be used to mount either pin or socket sides.

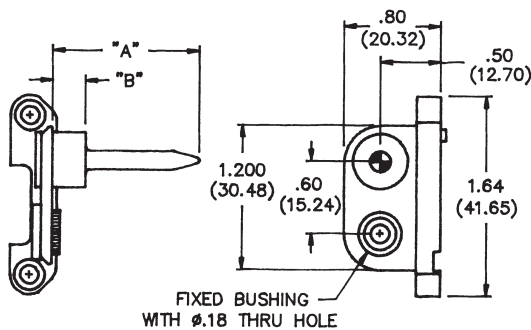

Fix-Mount, Guide Pin
Part Number 6648259-1
A = 1.22 (30.98), B = .275 (6.98)



Fix-Mount, Guide Socket
Part Number 6648263-1
A = .175 (4.44)



Float-Mount, Guide Pin
Part Number 6648251-1
Standard
A = 1.22 (30.98), B = .275 (6.98)
Part Number 6648253-1
L-Module
A = 1.62 (41.14), B = .125 (3.17)



Float-Mount, Guide Socket
Part Number 6648252-1
Standard
A = .175 (4.44)
Part Number 6648254-1
L-Module
A = .325 (8.25)

Note: All part numbers are RoHS compliant.

Domino Series Connectors (Continued)

**Domino Module
Assembly Process**

Cable Mounted Products



1. Align modules in desired order.



2. Measure length of assembly, and add .100" (2.54 mm) to determine overall rail length. Cut rails to length.



3. Slide locking rails into position on both sides of module assembly via the molded rail tracks.



4. Position end caps over locking rail ends and secure using Phillips head screws.

Domino Connector Layout Form

Instructions

1. Indicate the connector layout by filling in the Module letter for each module required in the boxes below, one per box. Use one form per mated pair.
2. Contacts are required for most modules, and are sold separately. Please see the High Current Drawer Section Contacts for specific part numbers.
3. The left to right order of the modules should match the **mating face views** of the connector.
4. Sign, date and send the completed form to your local Tyco Electronics Sales Engineer.

Upon receipt of this form, Tyco Electronics will generate a Customer Drawing for you to check and approve prior to connector production.



ENTER CUSTOMER INFORMATION	
Company	Location
Contact Name	Title
Telephone	Fax
Email Address	
I am: <input type="checkbox"/> End user <input type="checkbox"/> Contract manufacturer (end user:)	
Signature	Today's Date
Annual Quantity Required	

Pin Side:

--	--	--	--	--	--	--	--	--	--	--	--	--	--	--	--	--	--	--	--

Socket Side:

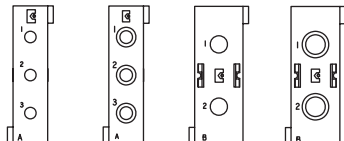
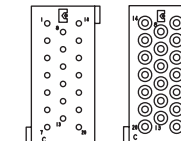
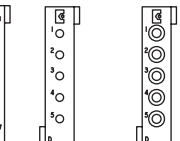
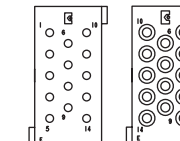
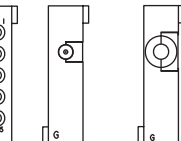
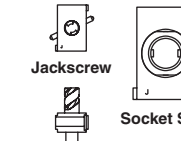
--	--	--	--	--	--	--	--	--	--	--	--	--	--	--	--	--	--	--	--

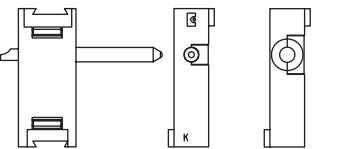
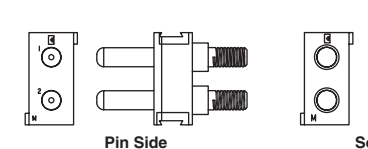
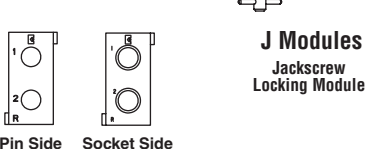
 <p>A Modules 3 x #12 Power Contacts Hot Plug</p>	 <p>B Modules 2 x #8 Power Contacts</p>	 <p>C Modules 20 x #20 Signal Contacts</p>	 <p>D Modules 5 x #16 Power Contacts</p>	 <p>E Modules 14 x #16 Power Contacts</p>	 <p>G Modules Non-Electrical Guide Modules</p>	 <p>J Modules Jackscrew Locking Module</p>
 <p>K Modules Electrically Active Guide/ Ground Module</p>	 <p>M Modules Pre-Installed Dual In-Line Crown Pin & Socket</p>	 <p>R Modules 2 x /14" Power Contacts</p>				

Domino Mounting Accessories



Screw (Steel)
Part Number 1766827-1



Locking Rail
Aluminum Alloy, 36" length (must cut to size)
Part Number 1648990-1
Locking Rail, 1' Interval
Part Number 1650469-1

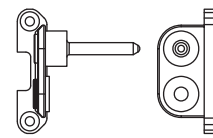

Fix-Mount End Cap
with Guide Pin

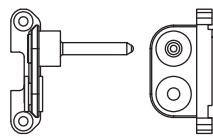

Float-Mount End Cap
with Guide Pin

Contacts

Please reference Power Connectors & Interconnection Systems Catalog 1773096 for contact part numbers.

Part Number	Quantity

Part Number	Quantity

Note: All part numbers are RoHS compliant.

HTS Power Connectors

Product Facts

- Heavy-duty, rectangular, multiple-position, pin and socket connectors
- Current rating: 10-500 A
- Voltage rating: 1-1.4 kV
- Number of contact positions: 1 through 216
- Connectors are designated by four components: base and hood, and male and female inserts
- Contact inserts provide for three types of wire termination: screw (no crimp tool required), crimp (higher pin count), and cage clamp (fastest)
- HE Series inserts (screw terminated) are the most popular
- Bases provide environmental (IP 55, 65 and 68) and electrical protection (NEMA 4 and 4X)
- Bases share an industry standard panel cutout and mounting hole pattern
- Hoods offer top, side, or angled cable entry. Hoods are tapped to accommodate metric or PG fittings
- Automated tooling matched to contact
- DIN/VDE, UL, CSA and SEV approved



HTS power connectors are heavy-duty, rectangular, multiple-position, pin and socket connectors. They are commonly referred to as “rectangular” or “European metal shell” connectors.

HTS connectors are designated by four components: base and hood, and male and female inserts. The designation is driven by electrical specifications; pin count and current rating define the inserts needed. From 1 to 216 contact positions are available. Current ratings range from 10-500 A.

The appropriate housing size (1-12) to accommodate selected inserts is then defined. Housing selection criteria include: base mounting style, latch type, hood cable entry location, and hood gland size. The most popular housing sizes are: Shell Size 1 (3 or 4 positions), Shell Size 3 (6 positions), Shell Size 6 (16 positions), Shell Size 8 (24 positions), and Shell Size 5 (25 positions).

HTS connectors have many applications: industrial machinery (automotive, plastics, semiconductors, material handling, packaging and printing), and railroad and mass transit (A/C and brake subsystems, power transformers, door systems, switches and signals, and drive motor enclosures).

For more information on the entire line of HTS heavy-duty connectors, see Catalog 889745-2.

HTS Power Connectors (Continued)

Contact Inserts

Series HVS

- High Variable System
- Zinc Frames Size 3 to 8 (acc. to Housing)
- For up to 6 Single Modules

Material

- PBT
- Flammability Rating: acc. UL 94 V-0



To offer a maximum of flexibility and reliability with a minimum of installation or maintenance effort Tyco Electronics developed the HVS product range (high variable system).

This system enables customers to build their own application specific connection and due to the combination variety of the different modules customers benefit in terms of reduced costs (cost efficiency) and less mounting space.

The HVS range comprises more than 25 different modules and the particular zinc frames which can then be mounted into all standard hoods and housings from Tyco Electronics. There is no tooling needed to put the modules in and out of the frame due to lever snap-in technology.

Up to 6 single modules can be used in a size 8 frame whereby the customer can individually define the combination of modules.

Signal, high current and high voltage, high density, Fire Wire, RJ45, USB, Coax, twisted pair, high speed and also pressure air are only some of the different connector modules. According to the insert contacts can be used individually.

In combination with the Tyco Electronics' hoods and housings IP ratings of IP 65 or even IP 68 can be realized. Customers also benefit from EMI- and corrosion-protection dependent on housing.

A large variety of customer specific applications complete the product range.



For more information on the entire line of HTS heavy-duty connectors, see Catalog 889745-2.

RAPID LOCK Quick Connect/Disconnect Bus Bar Connectors

Product Facts

- Replaces power lugs
- Locking feature “snaps” each contact to mating pin
- Up to 250 Amps per contact
- CROWN BAND connector technology provides low contact resistance

Typical Applications

- Power Distribution Systems
- Recognized under the Component Program of Underwriters Laboratories, File No. E28476 



The RAPID LOCK connector is a single-pole, quick connect/disconnect replacement for lug connections, used in bus bar and backplane power distribution applications. RAPID LOCK connectors allow a reliable and safe connection, as well as better serviceability, than bolt-fitted lugs. The cable mounted sockets have a right-angle configuration, and feature an insulator cap that provides the retention mechanism on the pin. The pin contacts can be attached to a bus bar by screw or swage, and to a backplane by press fit and backup screw.

Secure Power Distribution

By replacing power lugs fitted using nuts and bolts, the RAPID LOCK connector offers an extremely secure interconnect mechanism that totally frees the power distribution system from the risk of loose connections, which can cause arcing.

Safety Locking Feature

A locking feature is provided on the pins for protection against accidental unlatching of the cable. Although connection of the cable is easily performed by hand, disconnection requires a simple tool to provide the leverage needed to overcome the locking feature.

Improved Ease of Service

Service in the field becomes very easy with RAPID LOCK connectors because there are no nuts and washers to lose in the equipment. The RAPID LOCK connector is available with red or black color insulators.

CROWN BAND Technology

The RAPID LOCK connector enjoys all the benefits of the ELCON CROWN BAND technology, providing a stable connection with excellent mechanical and electrical performance with ratings up to 300 Amps depending on wire gauge and application.

Note: All RAPID LOCK Products in this section are RoHS compliant.

Note: All part numbers are RoHS compliant.

RAPID LOCK Quick Connect/Disconnect Bus Bar Connectors (Continued)

RAPID LOCK Connectors
Ordering Information

Size	Crimp Size	Part Numbers				
		Socket			Pin	
		Black	Red	Blue	Swage	Screw
#8	AWG #8	6648228-1	6648228-2	N/A	6648221-1	—
	AWG #12	6648237-1	6648237-2	N/A	6648221-1	N/A
	AWG #6	1766484-1	1766484-2	N/A	6648221-1	—
#4	AWG #8	6648235-1	6648235-2	N/A	6648222-1	—
	AWG #4	6648236-1	6648236-2	N/A	6648222-1	6648224-1
	AWG #6	6648239-1	6648239-2	N/A	6648222-1	—
#2	AWG #0	6648234-1	6648234-2	N/A	6648223-1	6648226-1
	AWG #2	6648238-1	6648238-2	N/A	6648223-1	6648226-1
12 mm	95 Sq. mm	N/A	1857547-1	1857547-2	1857523-3	N/A

Size	Insulation Boot			
	Black	Red	Grey	Blue
#4/#8	1651003-1	1651003-2	1651003-3	1651003-4
#2	1766600-1	1766600-2	1766600-3	1766600-4

Product Specifications

Materials	
Insulator	Thermoplastic, UL 94V-0 flammability rated
Socket Contact Body	Copper alloy, plated Silver over nickel
CROWN BAND	Beryllium Copper, plated Gold (30 micro inches minimum) over nickel
Pin Contact	Copper alloy, plated Silver over nickel
Electrical	
Current Rating @ 30°C T-rise	Size 8 — 50 Amps on 8 AWG wire Size 4 — 115 Amps on 4 AWG wire Size 2 — 145 Amps on 2 AWG wire Size 12 mm — 250 Amps on 95 mm ² wire
Contact Resistance	Size 8 — 0.5mΩ Size 4 — 0.15 mΩ Size 2 — 0.12 mΩ
Voltage Drop	See graphs
Mechanical	
Removal Tool	Part Number 1857376-1

Note: For more information about tooling, call Tooling Sales at 888-777-5917, (717)-810-2080 or e-mail toolingsales@tycoelectronics.com.

Test Data

Shown below is current versus temperature rise of the five different available socket sizes.

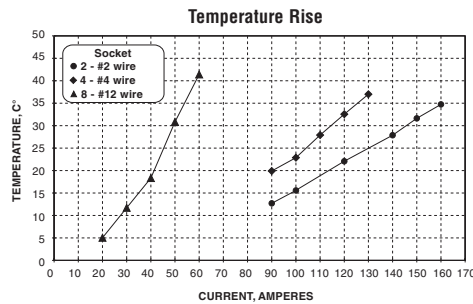

Shown below is current versus voltage drop performance of the five different available socket sizes.

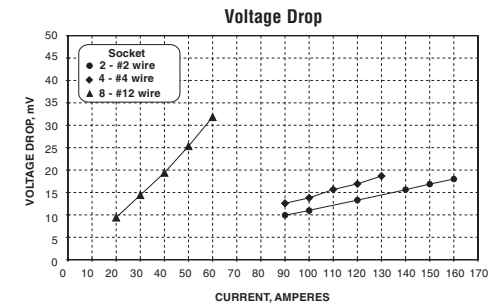

Note: All part numbers are RoHS compliant.

RAPID LOCK Quick Connect Sockets and Pins

Cable Mounted Sockets

RAPID LOCK sockets are crimped to AWG #4, #6 or #8 size cable depending on the application requirements. Envelope dimensions are common except for the crimp barrel diameter.



Part Number	Size	Dimensions			Cable AWG
		C	D	E	
6648228-X	#8	1.080	.500	.500	8
6648237-X		27.43	12.70	12.70	12
1766484-X					6
6648235-X	#4	1.08	.500	.500	8
6648236-X		27.43	12.70	12.70	4
6648239-X					6
6648234-X	#2	1.280	.490	.640	0
6648238-X		32.51	12.45	16.26	2
1857178-X					1/0
1857547-X	12.0 mm	1.920	.930	.930	3/0
		48.70	23.70	23.70	

Note: X refers to available color variants.

Pin Contacts

RAPID LOCK pin contacts are offered in either swage or screw & washer mounting options for .125" (3.18 mm) or 3 mm (.118") thick PCB or bus bars. Consult Tyco Electronics Customer Service for other bus bar and backplane thicknesses and designs.

Press Fit Pin Contacts

Attach Type	Pin Size	Mounts to
Screw and Washer	#4	Bus bar/Backplane
		Bus bar
Swage	#4	Bus bar

Note: All part numbers include attachment hardware (screw, washer, etc.)

Swage-Mount Pin



Part Number	Size	Dimensions	
		A	B
6648221-1	#8	.142	.550
		3.81	13.97
6648222-1	#4	.250	.550
		6.35	13.97
6648223-1	#2	.375	.550
		9.53	13.97
1857523-3*	12.0 mm	.470	.850
		12.00	21.70

*Requires washer Part Number 1857513-2

Screw-Mount Pin



Part Number	Size	Dimensions	
		A	B
6648224-1	#4	.250	.550
		6.35	13.97
6648226-1	#2	.375	.550
		9.53	13.97

Note: All part numbers are RoHS compliant.

Custom RAPID LOCK Connector Products

In addition to the flexibility offered with standard RAPID LOCK connector products, the basic technology and standard components may also be packaged to suit specific customer needs. Some examples of custom packages are given below.

Snap-Lock Sockets

Discrete pins are generally offered with or without a locking feature. A locking feature for a discrete socket is provided by a special two piece molding (94 V-0). This enables the socket to snap over a locking pin, and provides a 5 lb withdrawal force. The molding will also lock into a panel or holder of .125 (3.18) thickness.



Part Numbers	Wire Size	Color
1643279-1		Black
1643279-2	8 AWG	Red
1643279-3		Blue
1651766-1	4 AWG	Black

Press-Fit Discrete Contacts

Pins and sockets of the type shown are designed for press-fit to board or bus bar, and allow plug-in removal of a variety of board-mount components, discrete contacts, and flat-pack power supplies. Each socket contains a CROWN BAND contact, providing high current capacity and minimum loss, and accommodating misalignment.



Note: All part numbers are RoHS compliant.

AMP Power Taps

Product Facts

- **ACTION PIN** contacts eliminate soldering
- Provides high current, separable connection to pc board traces
- Wire-to-board connection using common terminals
- All metal-to-metal assembly for long-term integrity
- Standard DIP outlines (7.62 x 2.54 [.300 x .100]), 10 positions, and 6.35 x 3.18 [.250 x .125], 6 and 10 positions, plus high current versions on 10.16 x 5.08 [.400 x .200] footprint in 4 and 6 positions, 7.62 x 2.54 [.300 x .100] in 8 positions, and both 2 and 3 position in-line 2.54 [.100] tab taps
- Low resistance interface
- Internally threaded tap to secure screw to terminal
- Anti-rotational embossments hold wire and terminal in place
- Standard power taps rated at 2.5 Amps per pin — 6 position 15 Amps, 10 position 25 Amps current carrying capability
- High current power taps rated at up to 5 Amps per pin — 2 position 10 Amps, 3 position 15 Amps, 4 and 6 position 20 Amps and 8 position 40 Amps
- 30 Amp inverse sex power tap

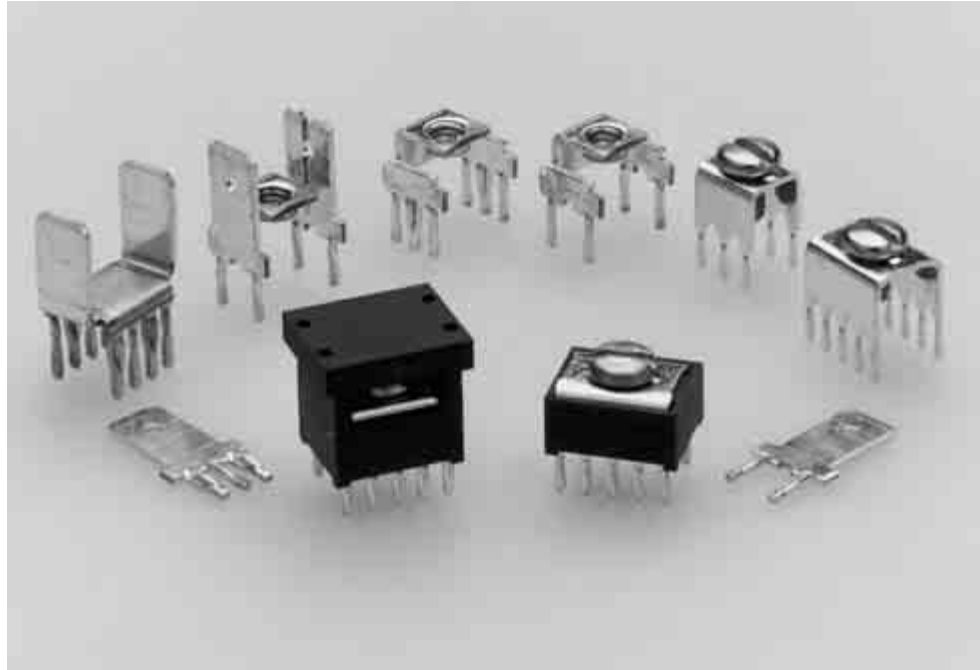

AMP power taps are designed for the growing need for power to printed circuit board applications required in today's electronic industry. The taps provide a high current, separable connection to a pc board. Pin configuration is of the standard DIP outline with 7.62 x 2.54 [.300 x .100] or 6.35 x 3.18 [.250 x .125] for the standard versions, plus 10.16 x 5.08 [.400 x .200], 7.62 x 2.54 [.300 x .100] and in-line spacing for the high current versions.

ACTION PIN contacts provide a low resistance interface with tin-plated through holes in the pc board, thereby eliminating the need for soldering.

The variety of available power taps allow for various installation schemes. The uninsulated tap and low profile tap can be used in bus bar pattern. The high profile and low profile taps offer insulation protection from other components. The high current versions provide a greater power

density option with current ratings from 10 Amps on the 2 position in-line 6.35 [.250] tab tap up to 40 Amps on the 8 position dual 6.35 [.250] tab tap.

All AMP power tap configurations are easily inserted into the pc board with a simple Tyco Electronics or customer supplied tool.

AMP Power Taps (Continued)

Material and Finish

Connector Body and Lid — Nylon, 105°C 94V-0 rated

Contact — Copper alloy, bright tin-lead or tin plated

Screw — Plated steel

Electrical and Mechanical Characteristics

Resistance — 2 milliohms, max. (stud hole to ACTION PIN contact)

Insertion Force — 40 lbs. [177.9N], max. per pin

Retention Force — 7 lbs. [31.1N], min. per pin

Technical Documents

Product Specification
108-11030 Tap, Power Distribution

Application Specification
114-11000 Tap, Power Distribution

Handbook
5697 Guide to Application of ACTION PIN Connectors

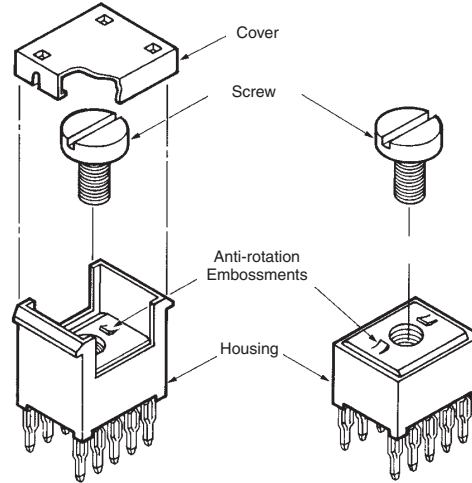

7.62 x 2.54 [.300 x .100]
High Profile Tap 10 Position

7.62 x 2.54 [.300 x .100]
Low Profile Tap 10 Position



Tap Version	PCB Thickness	Description	Screw Hole Size	Part Number	
				Tin Lead	Tin
High Profile	1.57-3.18 0.62-.125	Housing and Contact Assembled With Screw ^{1,2}	6-32	55557-4●	5055557-4
Low Profile	1.57-3.18 .062-.125	Housing and Contact Assembled With Screw ²	6-32	55556-4●	5055556-4
Low Profile	1.57-3.18 .062-.125	Housing and Contact Assembled With Screw ^{2,3}	6-32	55673-2●	5055673-2
Low Profile	1.57-3.18 .062-.125	Housing and Contact Assembled Without Screw	M4	55556-9●	5055556-9

¹Cover not Assembled

²Screw not Assembled

³No Anti-rotational Embossments

Note: Part Numbers are RoHS compliant except: ● Indicates "5 of 6 compliant" (lead in solderable interface only).

AMP Power Taps (Continued)

Material and Finish

Contact—Copper alloy, post plated bright tin-lead or tin plated
Screw—Stainless steel, passivated

Electrical and Mechanical Characteristics

Resistance — 2 milliohms, max. (stud hole to ACTION PIN contact)
Insertion Force — 40 lbs. [177.9N] max. per pin
Retention Force — 7 lbs. [31.1N] min. per pin

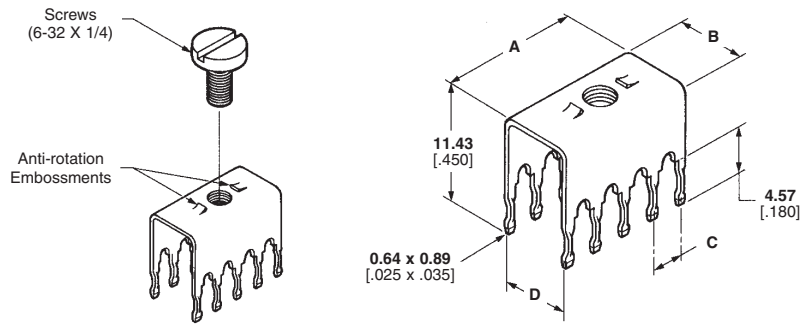

Size	PCB Thickness	Dimensions				Description	Screw Size	Part Number	
		A	B	C	D			Tin Lead	Tin
7.62 x 2.54 .300 x .100 10 Position	1.57-3.18 .062-.125	11.18 .440	8.26 .325	2.54 .100	7.62 .300	Without Screw	6-32	55558-3●	5055558-3
						With Screw	6-32	55558-4●	5055558-4
6.35 x 3.18 .250 x .125 6 Position	1.57-3.18 .062-.125	8.13 .320	6.99 .275	3.18 .125	6.35 .250	Without Screw	6-32	55323-5●	5055323-5
						With Screw	6-32	55323-9●	5055323-9
6.35 x 3.18 .250 x .125 10 Position	1.57-3.18 .062-.125	14.48 .570	6.99 .275	3.18 .125	6.35 .250	Without Screw	6-32	55323-6●	5055323-6
						With Screw	6-32	1-55323-0●	1-5055323-0

Cable Mounted Products

High Current* Power Taps

*Up to 20 Amps

Material and Finish

Contact — Phosphor bronze, tin-lead or tin plated
Screw — Stainless steel, passivated
Washer — Stainless steel

Electrical and Mechanical Characteristics

Current Rating — 20 Amps max.
Insertion Force — 40 lbs. [180N] max. per pin
Retention Force — 7 lbs. [30N] min. per pin



Size	PCB Thickness	Dimensions				Description	Part Number	
		A	B	C	D		Tin Lead	Tin
4 Position	1.57-3.18 .062-.125	9.09 .358	10.95 .431	5.08 .200	10.16 .400	With Screw, Washer	213815-1●	5213815-1
						Without Screw	216906-1●1	—
6 Position	1.57-3.18 .062-.125	9.09 .358	10.95 .431	2.54 .100	10.16 .400	With Screw, Washer	213816-1●	5213816-1
						Without Screw	216907-1●1	—

1No Anti-rotation Embossments featured on High Current Taps. Therefore, if application requires product supplied without washer and screw, use of lock-washers with a high surface contact area are strongly recommended.

For High Current and FASTON Taps

Use with Hand Press 677430-1

Recommended PC Board Layout

Drilled Hole Diameter—
1.60±0.03 [.063±.001]
Cu Thickness—
0.03-0.08 [.001-.003]
SnPb Thickness—
0.004 min. [.0002 min.]

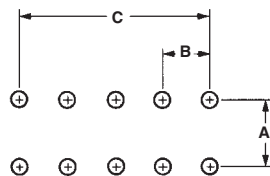

Finished Hole—
1.36-1.54 [.054-.061]
After Reflow—
1.36-1.54 [.054-.061]

Type	A	B	C
4 Position	10.16 .400	5.08 .200	5.08 .200
6 Position	10.16 .400	2.54 .100	5.08 .200
I	—	5.08 .200	5.08 .200
II	—	2.54 .100	5.08 .200
III	10.16 .400	5.08 .200	5.08 .200
IV	7.62 .300	2.54 .100	7.62 .300

Note: Part Numbers are RoHS compliant except: ●Indicates "5 of 6 compliant" (lead in solderable interface only).

AMP Power Taps (Continued)

*Up to 5 Amps per pin

Mating Connectors
FASTON Receptacles

Material and Finish

Contact — Phosphor bronze, post plated tin-lead or tin plated

Screw — Stainless steel, passivated

Washer — Stainless steel

Electrical and Mechanical Characteristics

Current Rating — 5 Amps max. per pin

Insertion Force — 40 lbs. [180N] max. per pin

For Recommended PC Board Layout, see page 170.



Style	PCB Thickness	Dimensions				Description	Part Number	Receptacle Mating
		A	B	C	D			
I	1.39 x 1.54 .055 x .061	13.50 .531	10.75 .423	18.50 .728	2.54 .100	2.8 x 0.80 .110 x .031 Tab	338429-2	Positive Lock
II	1.57 x 3.18 .062 x .125	5.08 .200	13.49 .531	—	—	6.35 x 0.81 .250 x .032 Tab	216926-1	Positive Lock
III	1.57 x 3.18 .062 x .125	2.54 .100	13.49 .531	—	—	6.35 x 0.81 .250 x .032 Tab	216843-1	Positive Lock
IV	1.57 x 3.18 .062 x .125	10.16 .400	5.08 .200	13.49 .531	10.95 .431	1-6.35 x 0.81 .250 x .032 Tab	216905-1 ¹	Positive Lock
						2-2.79 x 0.81 .110 x .032 Tab		
V	3.18 .125	7.62 .300	2.54 .100	12.32 .485	12.70 .500	2-6.35 x 0.81 .250 x .032 Tab	167892-3 ²	FASTON Rcpt.
						With Hole	167892-6 ²	Positive Lock

¹No Anti-rotation Embossments featured on High Current Taps. Therefore, if application requires product supplied without washer and screw, use of lock-washers with a high surface contact area are strongly recommended.

²Phosphor Bronze, post plated matte tin

Note: All part numbers are RoHS compliant.

AMP Power Taps (Continued)

**Application Tooling/
PCB Layout**

**For Standard Threaded
Taps Only**

**Recommended PC Board
Layout**

Drilled Hole Diameter—
.0453±.001 [1.15±0.03]

After Plating
.037-.043 [0.94-1.09]

After Reflow—
.036-.043 [0.91-1.09]

**Installation and Extraction
Tooling**

Impact Insertion Tool Number
313102-1
(Insertion Tip No. 58133-1 required)

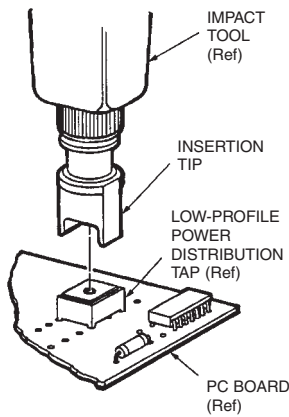
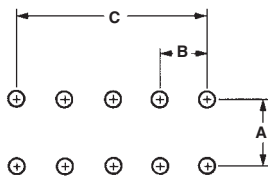

**Extraction Tool
Part Number 68380-1**

Size	Dimensions		
	A	B	C
.300 x .100 7.62 x 2.54 10 Position	.300 7.62	.100 2.54	.400 10.16
.250 x .125 6.35 x 3.18 6 Position	.250 6.35	.125 3.18	.250 6.35
250 x .125 6.35 x 3.18 10 Position	.250 6.35	.125 3.18	.500 12.7

Cable Mounted Products

**For High Current and
FASTON Taps**

Use with Hand Press **677430-1**

**Recommended PC Board
Layout**

Drilled Hole Diameter—
.063±.001 [1.60±0.03]

Cu Thickness—
.001-.003 [0.03-0.08]

SnPb Thickness—
.0002 min.[0.004 min.]

Finished Hole—
.055-.061 [1.39-1.54]

After Reflow—
.054-.061 [1.36-1.54]

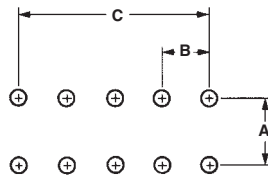

Type	A	B	C
4 Position	.400 10.16	.200 5.08	.200 5.08
6 Position	.400 10.16	.100 2.54	.200 5.08
I	—	.200 5.08	.200 5.08
II	—	.100 2.54	.200 5.08
III	.400 10.16	.200 5.08	.200 5.08
IV	.300 7.62	.100 2.54	.300 7.62

Installation Tooling

Type	Part Number	Upper Tool	Lower Tool
High Current 4 & 6 Positions	216906-1 216907-1	432848-1	433600-2 or 432130-2
High Current Style I, II	216926-1 216843-1	432845-1	433600-2 or 432130-2
High Current Style III	216905-1	432847-1	433600-2 or 432130-2
High Current Style IV	5167892-3 167892-6	432849-1	433600-2 or 432130-2

Note: All part numbers are RoHS compliant.

Mouser Electronics

Authorized Distributor

Click to View Pricing, Inventory, Delivery & Lifecycle Information:

[TE Connectivity:](#)

[1385663-2](#)