

T OPTION
PROVIDES CUTOUTS IN ORDER TO
ACCOMMODATE TABS

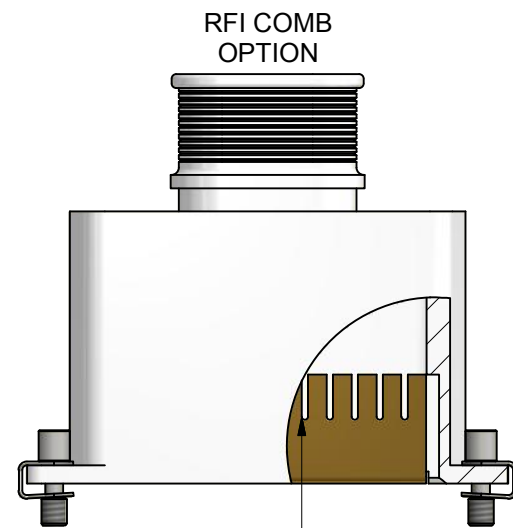
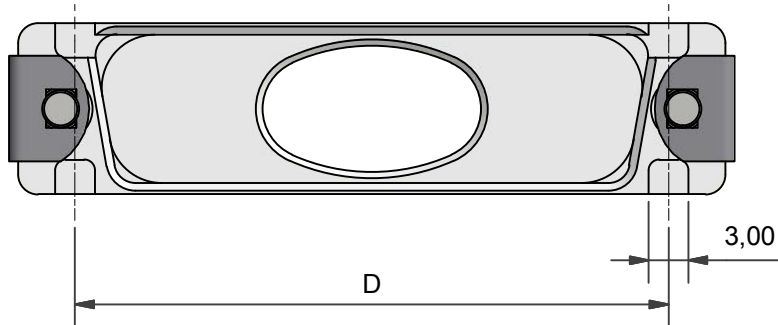

PUSH FIT RFI COMB
(SILVER PLATED BRASS)
COMB SUPPLIED SEPARATELY

HARDWARE OPTIONS

CODE: (NO CODE)
STANDARD
SLOTTED
HEAD SCREW

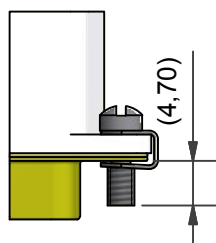

CODE: SSL
SHORT
SLOTTED
HEAD SCREW

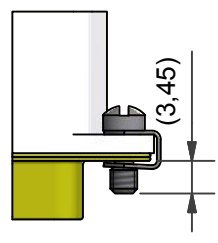

CODE: H
HEX SOCKET
HEAD SCREW

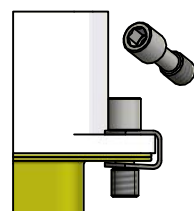

CODE: E
EXTENDED
SCREW

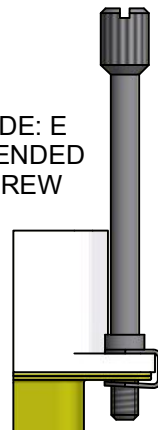

CODE: PF
JACK POST
(4-40 UNC)

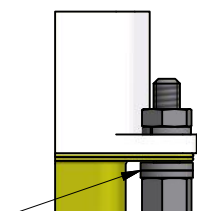

WASHERS
WASHERS
SHOWN FOR
REFERENCE
ONLY

CODE: PF-0
THREADED
HOLE
4-40 UNC

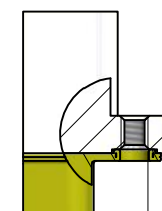

4-40UNC - 2B
NOT
SUPPLIED
WITH
HARDWARE

CODE: M3-0
THREADED
HOLE
M3

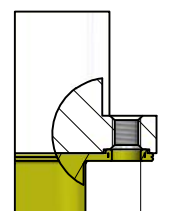

M3x0.5 - 6H
NOT
SUPPLIED
WITH
HARDWARE

ORDERS CANNOT BE PLACED AGAINST ALPHA ISSUED DRAWINGS.
ON RECEIPT OF CUSTOMER APPROVAL, THE DRAWING STATUS WILL BE RAISED TO ISSUE 1.

<table border="1"> <tr> <td>DRAWN</td> <td>DIW</td> <td>DATE</td> <td>04/08/2016</td> </tr> <tr> <td>SALES APPR</td> <td></td> <td>DATE</td> <td>04/08/2016</td> </tr> <tr> <td>DESIGN APPR</td> <td>K. SHEPPARD</td> <td>DATE</td> <td>02/03/2016</td> </tr> <tr> <td>PROD APPR</td> <td></td> <td></td> <td></td> </tr> <tr> <td>QUAL APPR</td> <td></td> <td></td> <td></td> </tr> <tr> <td>ISSUE</td> <td>REV.</td> <td>DCR</td> <td></td> </tr> <tr> <td>10</td> <td>2</td> <td>5821</td> <td></td> </tr> </table>	DRAWN	DIW	DATE	04/08/2016	SALES APPR		DATE	04/08/2016	DESIGN APPR	K. SHEPPARD	DATE	02/03/2016	PROD APPR				QUAL APPR				ISSUE	REV.	DCR		10	2	5821		<p>3RD ANGLE PROJECTION NOT TO SCALE</p>	<p>UNLESS OTHERWISE SPECIFIED ALL DIMENSIONS IN MILLIMETRES GENERAL TOL LINEAR +/-0,25MM ANGULAR +/- 1°</p> <p>MATERIAL SEE PART NUMBER BREAKDOWN</p> <p>FINISH SEE PART NUMBER BREAKDOWN</p>	<p>PART NUMBER: D**-1-BT**-**-*</p> <p>TITLE: D-SUB BANDING BACKSHELL</p> <p>ASSY USED ON: MIL-DTL-24308</p>	<p>Polamco</p> <p>TE connectivity</p>
DRAWN	DIW	DATE	04/08/2016																													
SALES APPR		DATE	04/08/2016																													
DESIGN APPR	K. SHEPPARD	DATE	02/03/2016																													
PROD APPR																																
QUAL APPR																																
ISSUE	REV.	DCR																														
10	2	5821																														
<p>NCAGE CODE U5792</p> <p>WEIGHT ---</p>	<p>THIS DRAWING IS COPYRIGHT AND THE PROPERTY OF POLAMCO LTD IT MUST NOT BE COPIED, USED FOR MANUFACTURE OR OTHERWISE DISCLOSED WITHOUT PRIOR WRITTEN CONSENT OF THE COMPANY.</p>	<p>POLAMCO LTD, WESTON LOCK, LOWER BRISTOL ROAD BATH BA2 1EP</p>	<p>SHT 1</p>	<p>DRAWING NO: P10143</p>																												

D25-1-BT-08E-1-C-T-L20-E

CONNECTOR TYPE _____

SHELL SIZE (SEE TABLE 1) _____

INSERT H FOR RFI COMB COMPATABILITY _____

ENTRY POSITION (TOP ENTRY) _____

TERMINATION STYLE _____
 (BT - BAND TERMINATION STYLE)

ENTRY SIZE (SEE TABLE 2) _____

INSERT E FOR ELLIPTICAL ENTRY _____
 ENTRY SIZES 07 AND ABOVE ONLY
 OMIT FOR STANDARD CIRCULAR ENTRY

MATERIAL (TABLE 3) _____

PLATING (TABLE 3) _____

T OPTION _____
 OMIT FOR STANDARD FLANGE

OPTIONAL LENGTH (5MM INCREMENTS) _____
 (OMIT FOR STANDARD LENGTH, STANDARD LENGTH = 30MM)

HARDWARE OPTION _____
 OMIT FOR STANDARD

TABLE 1

SHELL SIZE	MIL SPEC SHELL SIZE REFERENCE	A	B	C	D	MAX ENTRY (CIRCULAR)	MAX ENTRY (ELLIPTICAL)
09	1	31,19	25,00	12,93	22,86	06	08E
15	2	39,52	33,33	12,93	31,09	06	10E
25	3	53,42	47,02	12,93	44,86	06	12E
37	4	69,76	63,50	12,93	61,32	06	15E
50	5	67,31	61,12	15,75	58,98	08	16E
104	6	69,70	63,50	17,35	NA	09	18E

TABLE 2A

ENTRY SIZE (CIRCULAR)	G	H MAX
01	3,18	9,00
02	4,75	9,00
03	6,86	11,30
04	7,37	13,10
05	7,92	13,10
06	10,03	13,63
07	10,67	14,27
08	12,70	16,30
09	14,27	17,90

TABLE 2B

ENTRY SIZE (ELLIPTICAL)	E MIN	F MIN	J	EQUIV. CIRCULAR ENTRY DIAMETER
07E	13,0	9,5	16,6	(11,1)
08E	16,5	9,5	20,1	(12,7)
09E	20,5	9,5	24,1	(14,3)
10E	24,7	9,5	28,3	(15,9)
11E	29,4	9,5	33,0	(17,5)
12E	34,6	9,5	38,2	(19,1)
13E	40,2	9,5	43,8	(20,6)
14E	46,2	9,5	49,8	(22,2)
15E	52,7	9,5	56,3	(23,8)
16E	50,0	12,0	53,6	(25,4)
17E	49,2	13,9	52,8	(27,0)
18E	54,9	13,9	58,5	(28,6)

TABLE 3

CODE	MATERIAL / PLATING
1-C	ALUMINIUM / ELECTROLESS NICKEL
1-B	ALUMINIUM / CADMIUM OLIVE DRAB OVER ELECTROLESS NICKEL
1-U	ALUMINIUM / UNPLATED
1-ZB	ALUMINIUM / ZINC COBALT OLIVE DRAB OVER ELECTROLESS NICKEL
1-ZN	ALUMINIUM / ZINC NICKEL BLACK PASSIVATE OVER ELECTROLESS NICKEL
1-Y	ALUMINIUM / YELLOW CHROMATE OVER CADMIUM
4-J	STAINLESS STEEL / PASSIVATE

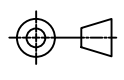
DRAWN	DIW	DATE	04/08/2016	 3RD ANGLE PROJECTION NOT TO SCALE	PART NUMBER:	
SALES APPR		DATE	04/08/2016		D**-1-BT-**-**-*	
DESIGN APPR	K. SHEPPARD	DATE	02/03/2016	UNLESS OTHERWISE SPECIFIED ALL DIMENSIONS IN MILLIMETRES GENERAL TOL LINEAR +/-0,25MM ANGULAR +/- 1°	TITLE:	D-SUB BANDING BACKSHELL
PROD APPR					ASSY USED ON:	
QUAL APPR					THIS DRAWING IS COPYRIGHT AND THE PROPERTY OF POLAMCO LTD IT MUST NOT BE COPIED, USED FOR MANUFACTURE OR OTHERWISE DISCLOSED WITHOUT PRIOR WRITTEN CONSENT OF THE COMPANY.	
ISSUE	REV.	DCR		MATERIAL SEE PART NUMBER BREAKDOWN FINISH SEE PART NUMBER BREAKDOWN	POLAMCO LTD, WESTON LOCK, LOWER BRISTOL ROAD BATH BA2 1EP	
10	2	5821			SHT	DRAWING NO:
NCAGE CODE U5792		WEIGHT	---	2	P10143	



Mouser Electronics

Authorized Distributor

Click to View Pricing, Inventory, Delivery & Lifecycle Information:

[TE Connectivity:](#)

[D37H-1-BT-15E-1-C-FSK](#)