

LOC	DIST	REVISIONS					
-	-	P	LTR	DESCRIPTION	DATE	DWN	APVD
		BA		NEW DRAWING	26APR2012	KR	St.P

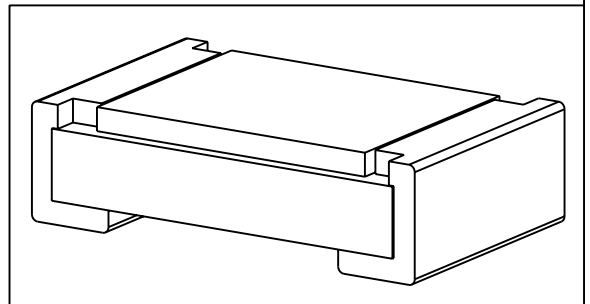

FOR FURTHER INFORMATION SEE DATA SHEET FOR  
SMD HIGH POWER PRECISION RESISTORS - RP73 SERIES

RoHS Compliant



20

RELEASED FOR PUBLICATION

ALL RIGHTS RESERVED.

THIS DRAWING IS UNPUBLISHED.

BY -

© COPYRIGHT 20

DIMENSIONS: mm	DWN RAGHAVENDRA K	26APR2012	MATERIAL	-	FINISH	-	
	CHK ALLAN P	26APR2012	 TE Connectivity				
TOLERANCES UNLESS OTHERWISE SPECIFIED:	APVD STEPHEN.P	26APR2012					
	0 PLC ±	PRODUCT SPEC	NAME	HIGH POWER PRECISION CHIP RESISTORS - TYPE RP73P 0805 SERIES			
1 PLC ±0.5	-	APPLICATION SPEC	SIZE	CAGE CODE	DRAWING NO	RESTRICTED TO	
2 PLC ±0.13	-	-	A 4	00779	©-2176094	-	
3 PLC ±0.013	WEIGHT	0.005 Gram	SCALE		40:1	SHEET	1 OF 1
4 PLC ±0.0001	CUSTOMER DRAWING		REV		BA		
ANGLES ±							

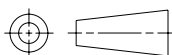

# Mouser Electronics

Authorized Distributor

Click to View Pricing, Inventory, Delivery & Lifecycle Information:

[TE Connectivity:](#)

[1-2176094-8](#)