

THIS DRAWING IS UNPUBLISHED. RELEASED FOR PUBLICATION
 © COPYRIGHT BY TYCO ELECTRONICS CORPORATION. ALL RIGHTS RESERVED.

LOC	DIST	REVISIONS			
P	LTR	DESCRIPTION	DATE	DWN	APVD
CM	00	A	WR-08-38	12AUG2008	KW CC

POSITION 1
IDENTIFICATION
FEATURE

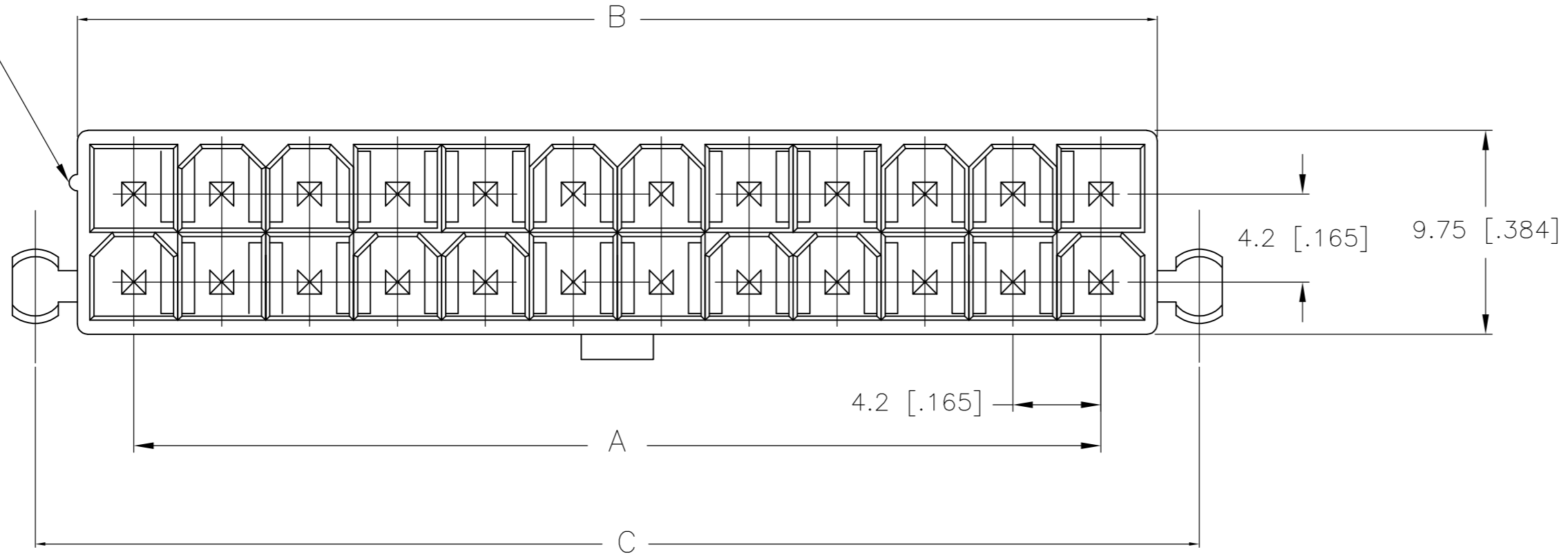

1 MATERIAL: HOUSING: NYLON, UL94V-2, BLUE
 CONTACTS: BRASS, TIN-PLATED

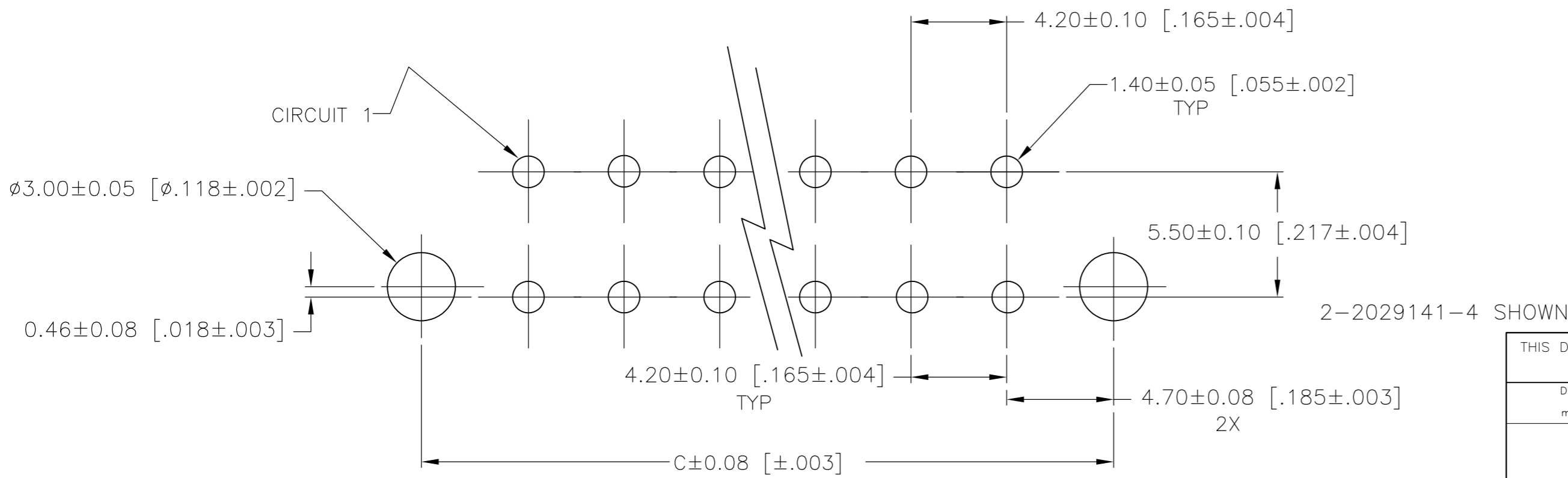
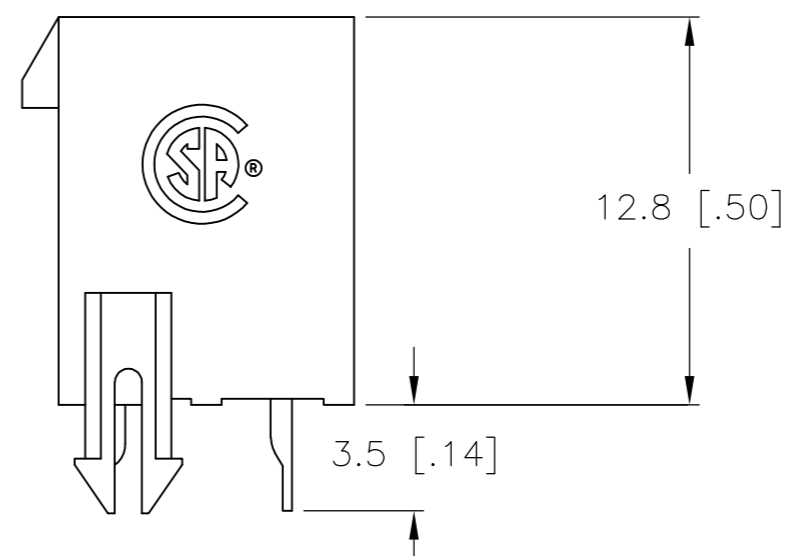
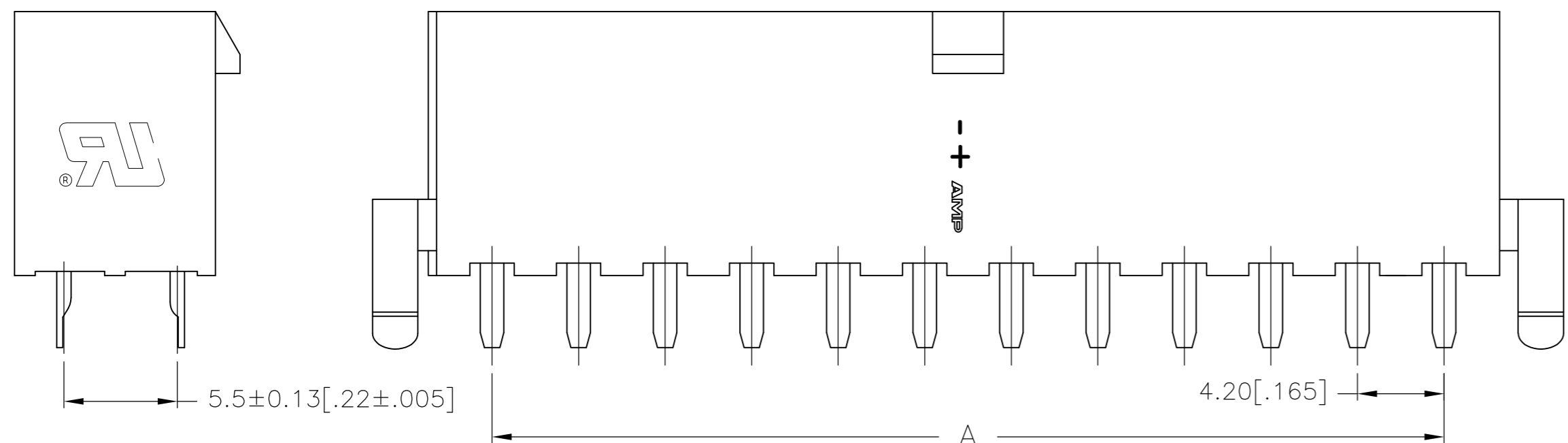

PCB LAYOUT: COMPONENT SIDE
 RECOMMENDED BOARD THICKNESS 1.78 [.070]



24	46.2±0.25 [1.82±.01]	51.6 [2.03]	55.6 [2.19]	2-2029141-4
22	42.0±0.25 [1.65±.01]	47.4 [1.87]	51.4 [2.02]	2-2029141-2
20	37.8±0.25 [1.49±.01]	43.2 [1.70]	47.2 [1.86]	2-2029141-0
18	33.6±0.25 [1.32±.01]	39.0 [1.54]	43.0 [1.69]	1-2029141-8
16	29.4±0.25 [1.16±.01]	34.8 [1.37]	38.8 [1.53]	1-2029141-6
14	25.2±0.25 [.99±.01]	30.6 [1.21]	34.6 [1.36]	1-2029141-4
12	21.0±0.25 [.83±.01]	26.4 [1.04]	30.4 [1.20]	1-2029141-2
10	16.8±0.13 [.66±.005]	22.2 [.87]	26.2 [1.03]	1-2029141-0
8	12.6±0.13 [.50±.005]	18.0 [.71]	22.0 [.87]	2029141-8
6	8.4±0.13 [.33±.005]	13.8 [.54]	17.8 [.70]	2029141-6
4	4.2±0.13 [.17±.005]	9.6 [.38]	13.6 [.54]	2029141-4
2	-	5.4 [.21]	9.4 [.37]	2029141-2
POS	A	B±0.25[.01]	C±0.38[.015]	PART NUMBER

THIS DRAWING IS A CONTROLLED DOCUMENT.

DWN K. WHITAKER 12AUG2008	Tyco Electronics Corporation Harrisburg, PA 17105-3608
CHK C. CASH 12AUG2008	
APVD C. CASH 12AUG2008	
PRODUCT SPEC	
APPLICATION SPEC	NAME VERTICAL HEADER, BLUE, WITH PEGS, WITH DRAIN HOLES, VAL-U-LOK(TM)
WEIGHT	SIZE A2
CUSTOMER DRAWING	CAGE CODE 00779
	DRAWING NO C=2029141
	RESTRICTED TO -
	SCALE 10:1
	SHEET 1 of 1
	REV A

Mouser Electronics

Authorized Distributor

Click to View Pricing, Inventory, Delivery & Lifecycle Information:

[TE Connectivity:](#)

[2-2029141-2](#)