

# Optocoupler—SMD, SOP and SSOP Packages OPIA400 through OPIA414



## Features:

- 2,500 to 5,000 Vrms electrical isolation
- Choice of a Single and Dual LED
- Phototransistor or Photo Darlington Sensor
- Low-cost plastic Dual-In-Line (DIP) package

## Agency Approvals:

- UL Certification No: E58730
- VDE pending

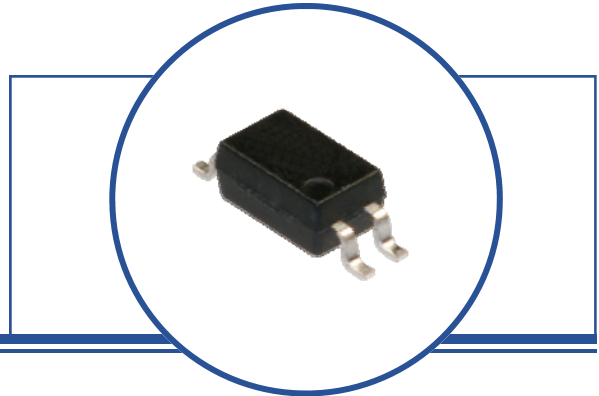

## Description:

The OPIA series optocouplers are designed for applications that use an analog output (Phototransistor or Photodarlington) in a surface mount package. A wide selection of configurations are available. With typical isolation voltage of 2,500 or 5,000 Volts RMS, these products meet typical power system isolation requirements.

Theory of operation: The LED transmitter is used to illuminate the Photosensor providing electrical isolation between two power systems while maintaining the ability to transmit information from one power system to the other. In many applications, analog signal levels may be required to be transmitted between two power systems while maintaining isolation between the power systems up to 5,000 volts RMS. A variety of LED and photosensor configurations are available depending on the system requirements.

The ratio Current Transfer Ratio (CTR) is identified between the output current and input current for analog photosensors. CTR ratios can range from as low as 5 to over 9,000 depending on the device.

$$CTR = \frac{\text{Photosensor - Current}}{\text{LED - Current}} = \frac{20mA}{10mA} * 100 = 200$$

All SMD products are shipped in a shipping tube with "TR" identified on the end of the part number.

Example: OPI400ATR is a 4-Pin SMD shipped in tape and reel (TR)

## Applications:

- High voltage isolation, up to 5,000 Volts RMS
- PCBoard power system isolation
- Industrial equipment power isolation
- Medical equipment power isolation
- Office equipment



RoHS

OPTEK reserves the right to make changes at any time in order to improve design and to supply the best product possible.

# Optocoupler—SMD, SOP and SSOP Packages

## OPIA400 through OPIA414



### Package Outline Dimensions and Schematics: Top-View

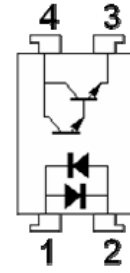
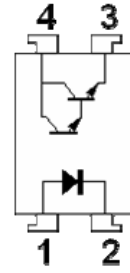
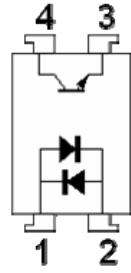
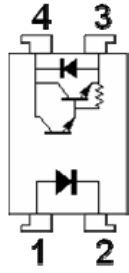
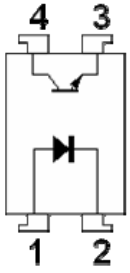

**OPIA400**  
**OPIA404**  
**OPIA405**  
**OPIA413**  
**OPIA414**

**OPIA401**  
**OPIA409**  
**OPIA412**

**OPIA402**  
**OPIA407**  
**OPIA410**

**OPIA403**  
**OPIA406**  
**OPIA411**

**OPIA408**  
 Package Style B  
 (SOP)

Package Style C  
 (SSOP)

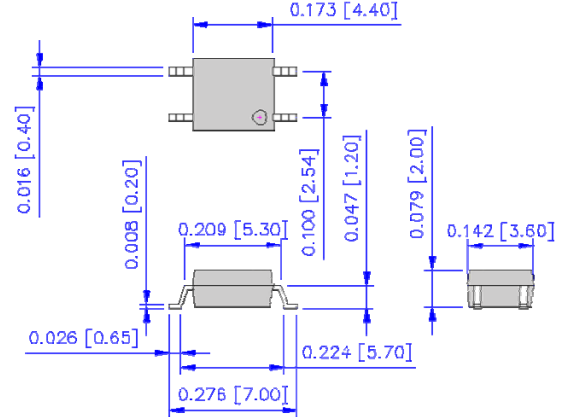
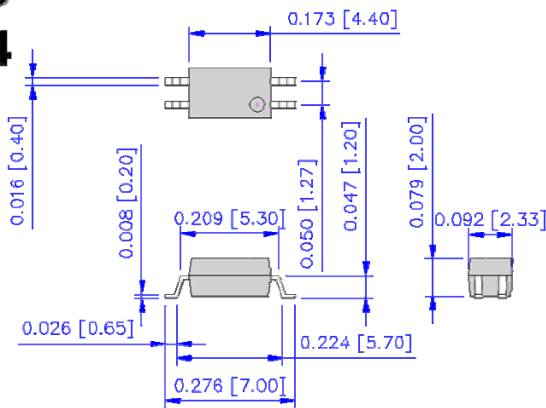

Part Number	Pin #			
	1	2	3	4
OPIA400A	A	K	E	C
OPIA401B	A	K	E	C
OPIA402B	A-K	K-A	E	C
OPIA403B	A	K	E	C
OPIA404B	A	K	E	C
OPIA405C	A	K	E	C
OPIA406C	A	K	E	C
OPIA407C	A-K	K-A	E	C
OPIA408C	A	K	E	C
OPIA409C	A	K	E	C
OPIA410A	A-K	K-A	E	C
OPIA411A	A	K	E	C
OPIA412A	A	K	E	C
OPIA413A	A	K	E	C
OPIA414B	A	K	E	C

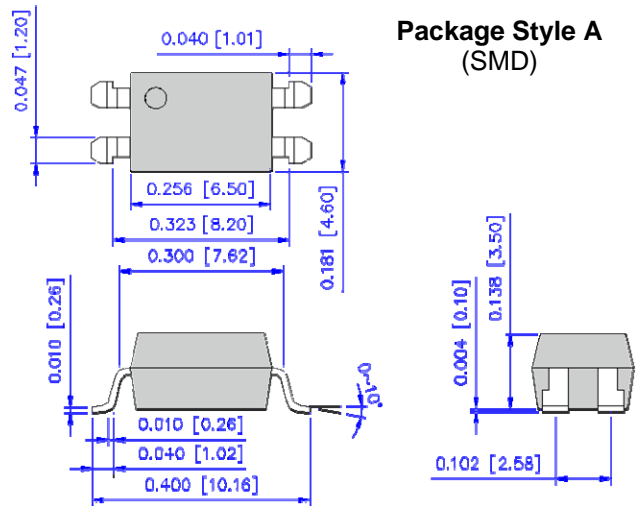

Package Style A  
 (SMD)

OPTEK reserves the right to make changes at any time in order to improve design and to supply the best product possible.

# Optocoupler—SMD, SOP and SSOP Packages

## OPIA400 through OPIA414



### Analog Output Devices Ordering Information

Part Number	Isolation Voltage Max. (Vrms)	CTR Min/Typ/Max	Typ. Tr / Tf (µs) R <sub>L</sub> = 100 ohms	Package	Configuration
OPIA400A	5,000	50 / - / 600	4 / 3	4-Pin SMD	A K—C E
OPIA401B	3,750	1,000 / - / -	100 / 20	4-Pin SOP	A K—C E (Dar)
OPIA402B	3,750	20 / - 400	4 / 3	4-Pin SOP	A K, K A—C E
OPIA403B	3,750	600 / 1,600 / 7,500	60 / 53	4-Pin SOP	A K—C E (Dar)
OPIA404B	3,750	50 / - / 600	5 / 4	4-Pin SOP	A K—C E
OPIA405C	2,500	80 / - / 600	3 / 5	4-Pin SSOP	A K—C E
OPIA406C	2,500	200 / 2,000 / -	200 / 200	4-Pin SSOP	A K—C E (Dar)
OPIA407C	2,500	80 / - / 600	3 / 5	4-Pin SSOP	A K, K A—C E
OPIA408C	2,500	200 / 2,000 / -	200 / 200	4-Pin SSOP	A K—C E (Dar)
OPIA409C	2,500	400 / 2,000 -	40 / 10	4-Pin SSOP	A K—C E (Dar)
OPIA410A	5,000	60 / - / 600	5 / 4	4-Pin SMD	A K, K A—C E
OPIA411A	5,000	70 / - / -	80 / 72	4-Pin SMD	A K—C E (Dar)
OPIA412A	5,000	600 / - / 9,000	60 / 50	4-Pin SMD	A K—C E (Dar)
OPIA413A	5,000	50 / - / 600	2 / 3	4-Pin SMD	A K—C E
OPIA414B	3,750	100 / - / 600	4 / 3	4-Pin SOP	A K—C E
Configuration: Definition of Terms LED Identification—Sensor Identification					
Configuration Information	LED	A = Anode	K = Cathode		
	Sensor	B = Base	C = Collector	E = Emitter	(Dar) = Photodarlington
Packaging	Part Number Suffix: <b>TU</b> = Shipped in Tubes				Example: OPIA400DTU

OPTEK reserves the right to make changes at any time in order to improve design and to supply the best product possible.

# Optocoupler—SMD, SOP and SSOP Packages

## OPIA400 through OPIA414



### Absolute Maximum Ratings ( $T_A = 25^\circ\text{C}$ unless otherwise noted)

Storage Temperature OPIA400, OPIA404, OPIA410, OPIA411, OPIA412, OPIA413, OPIA414 OPIA401, OPIA402, OPIA403 OPIA405, OPIA406, OPIA407, OPIA408, OPIA409	-55° C to +125° C -40° C to +125° C -55° C to +150° C
Operating Temperature All except the part numbers noted below OPIA404 OPIA414	-30° C to +100° C -55° C to +115° C -30° C to +115° C
Isolation voltage (1 minute) OPIA400, OPIA410, OPIA411, OPIA412, OPIA413 OPIA401, OPIA402, OPIA403, OPIA404, OPIA414 OPIA405, OPIA406, OPIA407, OPIA408, OPIA409	5,000 Vrms 3,750 Vrms 2,500 Vrms
Total Package Power Dissipation OPIA400, OPIA410, OPIA411, OPIA412, OPIA413 OPIA401, OPIA402, OPIA403, OPIA404, OPIA414 OPIA405 OPIA406, OPIA407, OPIA408, OPIA409	200 mW 170 mW 160 mW -
Lead Soldering Temperature (1/16" (1.6 mm) from case for 5 seconds with soldering iron)	260° C

### Input Diode

Continuous Forward Current All except the part number noted below OPIA414	50 mA 10 mA
Peak Forward current (1 $\mu\text{s}$ pulse width, 300 pps) All except the part number noted below OPIA414	1 A 200 mA
Reverse Voltage OPIA400, OPIA401, OPIA403, OPIA404, OPIA405, OPIA406, OPIA409, OPIA411, OPIA412, OPIA413, OPI414 OPIA402, OPIA407, OPIA408, OPIA409, OPIA410, OPIA412	6 V -
Power Dissipation OPIA400, OPIA401, OPIA402, OPIA403, OPIA404, OPIA410, OPIA412, OPIA413, OPIA411 OPIA405, OPIA406, OPIA407, OPIA408, OPIA409 OPIA414	70 mW 60 mW 15 mW

### Output Phototransistor

Collector-Emitter Voltage OPIA400, OPIA402, OPIA404, OPIA410 OPIA401, OPIA409, OPIA412 OPIA403, OPIA411 OPIA406, OPIA408 OPIA413 OPIA405, OPIA407, OPIA414	60 V 300 V 35 V 40 V 350 V 80 V
Emitter-Collector Voltage OPIA400, OPIA405, OPIA406, OPIA407, OPIA408, OPIA410, OPIA411 OPIA401, OPIA412 OPIA402, OPIA403, OPIA404 OPIA409 OPIA413, OPIA414	6 V 0.1 V 5 V 0.3 V 7 V
Collector Current OPIA400, OPIA402, OPIA404, OPIA405, OPIA407, OPIA410, OPIA413, OPIA414 OPIA401, OPIA403, OPIA412 OPIA406, OPIA408 OPIA409 OPIA411	50 mA 150 mA 90 mA 60 mA 80 mA
Power Dissipation All except the part numbers noted below OPIA405, OPIA406, OPIA407, OPIA408, OPI409 OPIA412	150 mW 120 mW 200 mW

OPTEK reserves the right to make changes at any time in order to improve design and to supply the best product possible.

# Optocoupler—SMD, SOP and SSOP Packages

## OPIA400 through OPIA414



### Electrical Characteristics

SYMBOL	PARAMETER	MIN	TYP	MAX	UNITS	TEST CONDITIONS
<b>Input Diode</b>						
$V_F$	Forward Voltage	-	1.2	1.4	V	$I_F = 20\text{ mA}$ $I_F = 10\text{ mA}$ $I_F = 5\text{ mA}$ $I_F = 10\text{ mA}$ $I_F = 10\text{ mA}$
	All except those noted below	-	1.6	1.75		
	OPIA404	-	1.1	1.4		
	OPIA405, OPIA406, OPIA407, OPIA408	-	1.2	1.4		
	OPIA401, OPIA409, OPIA414	1.0	1.2	1.3		
$V_{FM}$	Peak Forward Voltage	-	-	3.5	V	$I_{FM} = 500\text{ mA}$
	OPIA403, OPIA410, OPIA412	-	-	3.0		
	OPIA400, OPIA405, OPIA411, OPIA413	-	-	-		
$I_R$	Reverse Current	-	-	10	$\mu\text{A}$	$V_R = 4\text{ V}$ -
	All except those noted below	-	-	-		
	OPIA404, OPIA407, OPIA408, OPIA410, OPIA414	-	-	5		
	OPIA405, OPIA406, OPIA409	-	-	10		
$C_t$	Terminal Capacitance	-	30	-	pf	$V = 0.0\text{ V}, f = 1\text{ K Hz}$ $V = 0.0\text{ V}, f = 1\text{ K Hz}$ $V = 0.0\text{ V}, f = 1\text{ M Hz}$
	All except those noted below	-	30	250		
	OPIA402, OPIA404, OPIA411, OPIA414	-	60	-		

### Output Phototransistor

$I_{CEO}$	Collector dark Current	-	-	100	nA	$I_F = 0\text{ mA}, V_{CE} = 20\text{ V}$ $I_F = 0\text{ mA}, V_{CE} = 80\text{ V}$ $I_F = 0\text{ mA}, V_{CE} = 300\text{ V}$ $I_F = 0\text{ mA}, V_{CE} = 50\text{ V}$
	OPIA400, OPIA402, OPIA404, OPIA410	-	-	100		
	OPIA405, OPIA407	-	10	200		
	OPIA413	-	-	100		
$V_{CE(SAT)}$	Collector-emitter Saturation Voltage	-	0.1	0.2	V	$I_F = 20\text{ mA}, I_C = 1\text{ mA}$ $I_F = 10\text{ mA}, I_C = 2\text{ mA}$ $I_F = 20\text{ mA}, I_C = 1\text{ mA}$ $I_F = 8\text{ mA}, I_C = 2.4\text{ mA}$ $I_F = 10\text{ mA}, I_C = 1\text{ mA}$
	OPIA400	-	0.1	0.3		
	OPIA405, OPIA407	-	0.1	0.3		
	OPIA402, OPIA404, OPIA410	-	-	0.4		
	OPIA413	-	0.1	0.2		
$f_C$	Cutt-Off frequency	-	-	-	K Hz	$V_{CC} = 5\text{ V}, I_C = 2\text{ mA}, R_L = 100\ \Omega$
	All except those noted below	-	80	-		
$t_R$	Rise Time	-	4	18	$\mu\text{s}$	$V_{CC} = 2\text{ V}, I_C = 2\text{ mA}, R_L = 100\ \Omega$ $V_{CC} = 5\text{ V}, I_C = 2\text{ mA}, R_L = 100\ \Omega$ $V_{CC} = 2\text{ V}, I_C = 2\text{ mA}, R_L = 100\ \Omega$ $V_{CC} = 10\text{ V}, I_C = 2\text{ mA}, R_L = 100\ \Omega$
	OPIA400, OPIA402, OPIA414	-	3	18		
	OPIA405, OPIA407	-	5	20		
	OPIA404, OPIA410	-	2	-		
$t_F$	Fall Time	-	3	18	$\mu\text{s}$	$V_{CC} = 2\text{ V}, I_C = 2\text{ mA}, R_L = 100\ \Omega$ $V_{CC} = 5\text{ V}, I_C = 2\text{ mA}, R_L = 100\ \Omega$ $V_{CC} = 2\text{ V}, I_C = 2\text{ mA}, R_L = 100\ \Omega$ $V_{CC} = 10\text{ V}, I_C = 2\text{ mA}, R_L = 100\ \Omega$
	OPIA400D, OPIA402, OPIA414	-	5	18		
	OPIA405, OPIA407	-	4	20		
	OPIA404, OPIA410	-	3	-		
	OPIA413	-	-	-		

Continued on Next Page

OPTEK reserves the right to make changes at any time in order to improve design and to supply the best product possible.

# Optocoupler—SMD, SOP and SSOP Packages

## OPIA400 through OPIA414



### Electrical Characteristics (OPIA400 Series) - Continued from Previous Page

SYMBOL	PARAMETER	MIN	TYP	MAX	UNITS	TEST CONDITIONS
<b>Output PhotoDarlington</b>						
$I_{CEO}$	Collector dark Current OPIA401, OPIA412 OPIA403, OPIA411 OPIA406, OPIA408 OPIA409	- - - -	- - - -	1.0 1.0 0.4 0.4	$\mu$ A	$I_F = 0$ mA, $V_{CE} = 200$ V $I_F = 0$ mA, $V_{CE} = 10$ V $I_F = 0$ mA, $V_{CE} = 40$ V $I_F = 0$ mA, $V_{CE} = 300$ V
$V_{CE(SAT)}$	Collector-emitter Saturation Voltage OPIA403 OPIA406, OPIA408, OPIA409 OPIA411 OPIA412 OPIA401	- - - - -	- - 0.8 - -	1.0 1.0 1.0 1.5 1.5	V	$I_F = 20$ mA, $I_C = 1$ mA $I_F = 1$ mA, $I_C = 2$ mA $I_F = 20$ mA, $I_C = 5$ mA $I_F = 20$ mA, $I_C = 5$ mA $I_F = 20$ mA, $I_C = 100$ mA
$f_c$	Cut-Off frequency OPIA401, OPIA406, OPIA408, OPIA409 OPIA411 OPIA403, OPIA412	- 1.0 -	- 6.0 7.0	- - -	K Hz	- $V_{CC} = 2$ V, $I_C = 20$ mA, $R_L = 100$ $\Omega$ $V_{CC} = 5$ V, $I_C = 2$ mA, $R_L = 100$ $\Omega$
$t_r$	Rise Time OPIA401 OPIA403 OPIA406, OPIA408 OPIA409 OPIA411 OPIA412	- - - - - -	100 60 200 40 80 60	300 300 - - 300 300	$\mu$ s	$V_{CC} = 2$ V, $I_C = 20$ mA, $R_L = 100$ $\Omega$ $V_{CC} = 2$ V, $I_C = 2$ mA, $R_L = 100$ $\Omega$ $V_{CC} = 5$ V, $I_C = 2$ mA, $R_L = 100$ $\Omega$ $V_{CC} = 5$ V, $I_C = 10$ mA, $R_L = 100$ $\Omega$ $V_{CC} = 2$ V, $I_C = 20$ mA, $R_L = 100$ $\Omega$ $V_{CC} = 2$ V, $I_C = 20$ mA, $R_L = 100$ $\Omega$
$t_f$	Fall Time OPIA401 OPIA403 OPIA406, OPIA408 OPIA409 OPIA411 OPIA412	- - - - - -	20 53 200 10 72 50	100 250 - - 250 250	$\mu$ s	$V_{CC} = 2$ V, $I_C = 20$ mA, $R_L = 100$ $\Omega$ $V_{CC} = 2$ V, $I_C = 2$ mA, $R_L = 100$ $\Omega$ $V_{CC} = 5$ V, $I_C = 2$ mA, $R_L = 100$ $\Omega$ $V_{CC} = 5$ V, $I_C = 10$ mA, $R_L = 100$ $\Omega$ $V_{CC} = 2$ V, $I_C = 20$ mA, $R_L = 100$ $\Omega$ $V_{CC} = 2$ V, $I_C = 20$ mA, $R_L = 100$ $\Omega$

### Coupled Characteristics

$CTR$	Current Transfer Ratio OPIA400, OPIA404, OPIA413 OPIA401 OPIA402 OPIA403 OPIA405 OPIA406, OPIA408 OPIA407 OPIA409 OPIA410 OPIA411 OPIA412 OPIA414	50 1,000 20 600 80 20 0.3 400 60 70 600 100	- - - - - 2,000 1.0 2,000 - - - -	600 - 400 7,500 600 - 3.0 - - 600 - 9,000 600	%	$I_F = 5.00$ mA, $V_{CE} = 5.0$ V $I_F = 1.00$ mA, $V_{CE} = 2.0$ V $I_F = 1.00$ mA, $V_{CE} = 5.0$ V $I_F = 1.00$ mA, $V_{CE} = 2.0$ V $I_F = 5.00$ mA, $V_{CE} = 5.0$ V $I_F = 1.00$ mA, $V_{CE} = 2.0$ V $I_F = 5.00$ mA, $V_{CE} = 5.0$ V $I_F = 1.00$ mA, $V_{CE} = 2.0$ V $I_F = 1.00$ mA, $V_{CE} = 2.0$ V $I_F = 0.05$ mA, $V_{CE} = 3.3$ V $I_F = 1.00$ mA, $V_{CE} = 2.0$ V $I_F = 1.00$ mA, $V_{CE} = 5.0$ V
$C_f$	Floating Capacitance OPIA405, OPIA406, OPIA407, OPIA408, OPIA409	- -	0.6 0.4	1.0 -	pF	$V = 0.0$ V, $f = 1$ M Hz
$R_{ISO}$	Isolation resistance	$5 \times 10^{10}$	$10^{11}$	-	ohm	C500V, 40% to 60%RH

OPTEK reserves the right to make changes at any time in order to improve design and to supply the best product possible.

### OPIA400

**Fig.1 Current Transfer Ratio vs. Forward Current**

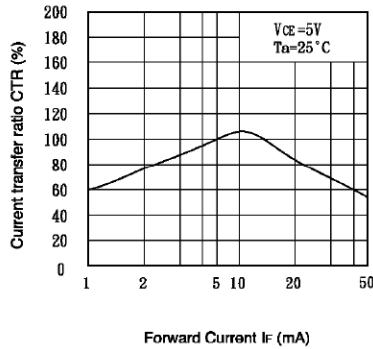

**Fig.2 Collector Power Dissipation vs. Ambient Temperature**

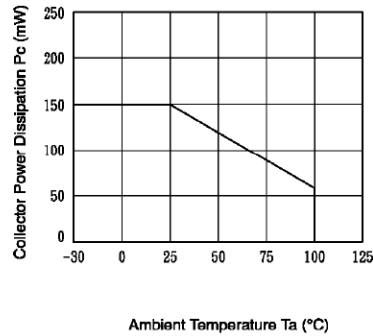

**Fig.3 Collector Dark Current vs. Ambient Temperature**

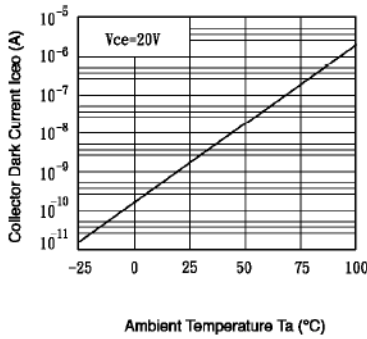

**Fig.4 Forward Current vs. Ambient Temperature**

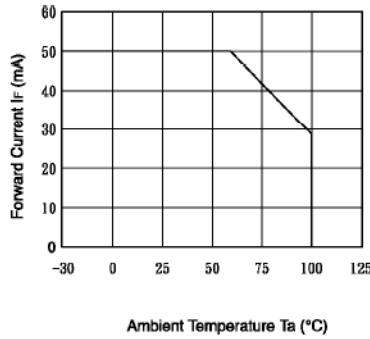

**Fig.5 Forward Current vs. Forward Voltage**

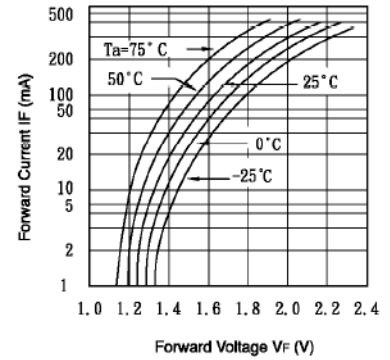

**Fig.6 Collector Current vs. Collector-emitter Voltage**

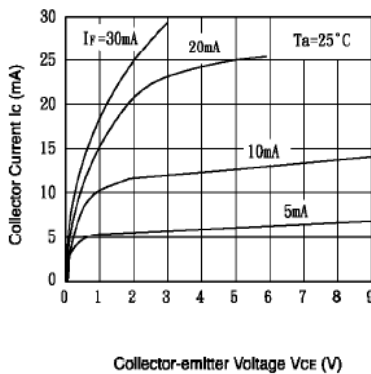

**Fig.7 Relative Current Transfer Ratio vs. Ambient Temperature**

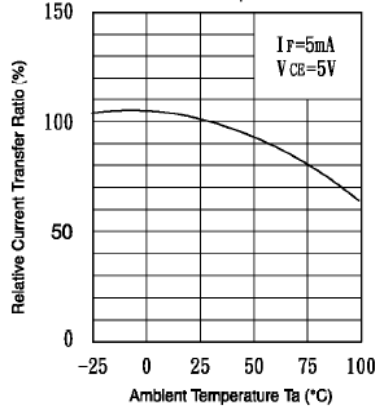

**Fig.8 Collector-emitter Saturation Voltage vs. Ambient Temperature**

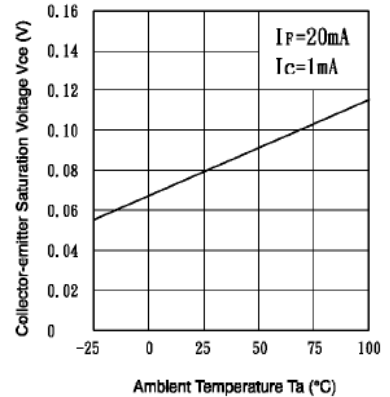

OPTeK reserves the right to make changes at any time in order to improve design and to supply the best product possible.

## OPIA400

**Fig.9 Collector-emitter Saturation Voltage vs. Forward Current**

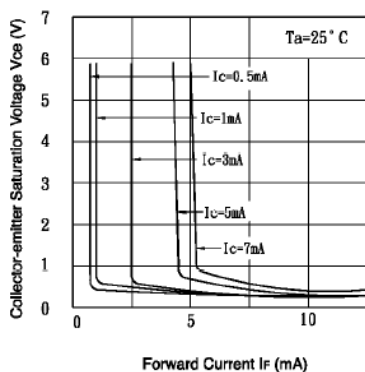

**Fig.10 Response Time vs. Load Resistance**

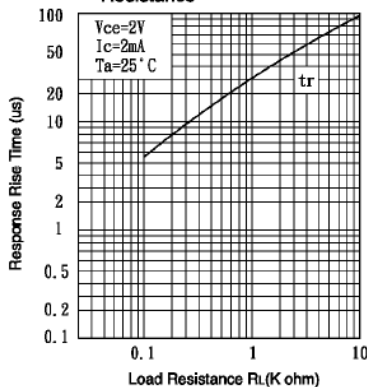

**Fig.11 Response Time vs. Load Resistance**

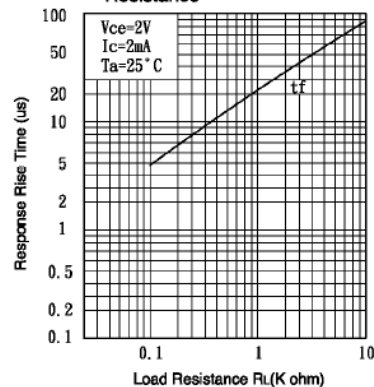

OPTEK reserves the right to make changes at any time in order to improve design and to supply the best product possible.



## OPIA401

**Fig.1 Forward Current vs. Ambient Temperature**

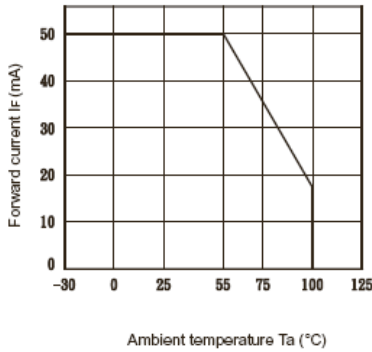

**Fig.2 Collector Power Dissipation vs. Ambient Temperature**

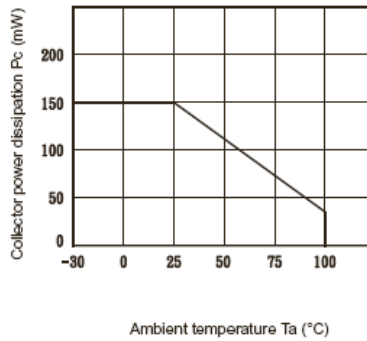

**Fig.3 Peak Forward Current vs. Duty Ratio**

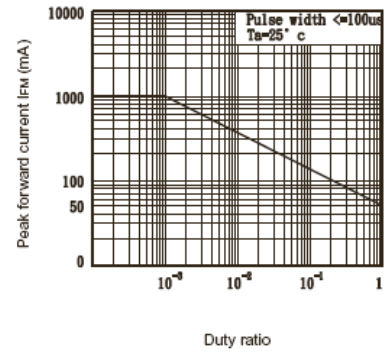

**Fig.4 Forward Current vs. Forward Voltage**

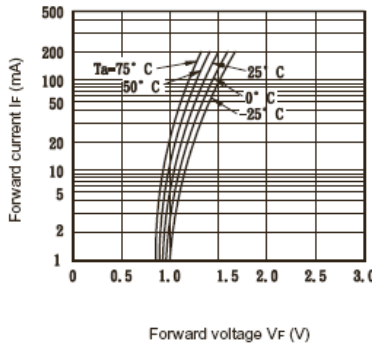

**Fig.5 Current Transfer Ratio vs. Forward Current**

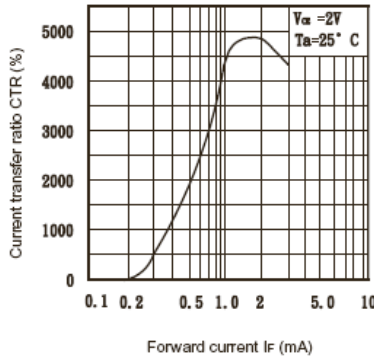

**Fig.6 Collector Current vs. Collector-emitter Voltage**

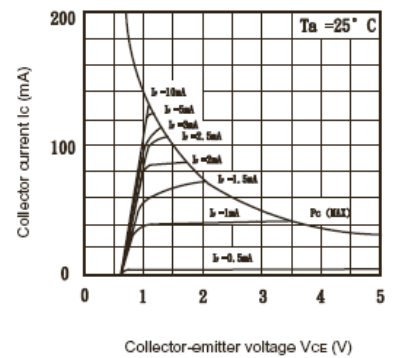

**Fig.7 Relative Current Transfer Ratio vs. Ambient Temperature**

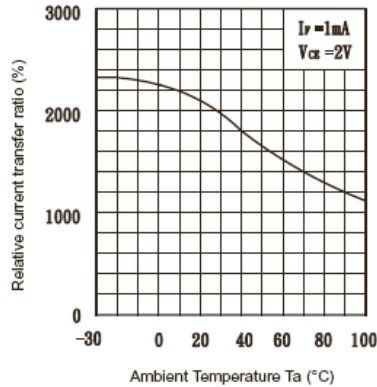

**Fig.8 Collector-emitter Saturation Voltage vs. Ambient Temperature**

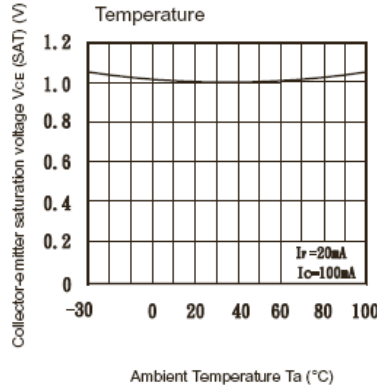

**Fig.9 Collector Dark Current vs. Ambient Temperature**

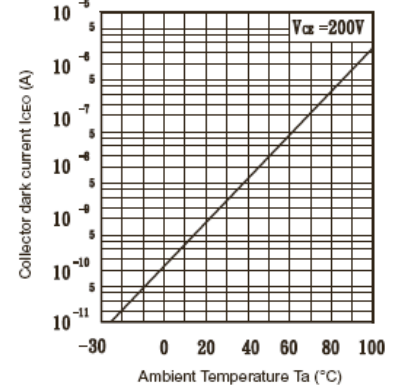

OPTEK reserves the right to make changes at any time in order to improve design and to supply the best product possible.

## OPIA401

Fig.10 Response Time vs. Load Resistance

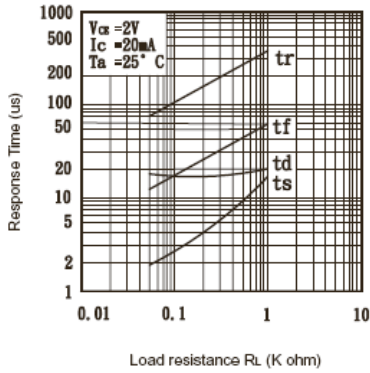

Fig.11 Frequency Response

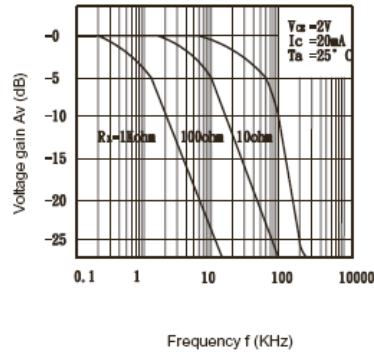
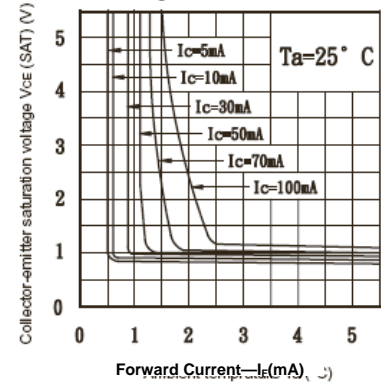

Fig.12 Collector-emitter Saturation Voltage vs. Forward current



OPTEK reserves the right to make changes at any time in order to improve design and to supply the best product possible.

OPIA402

Fig.1 Forward Current vs. Ambient Temperature

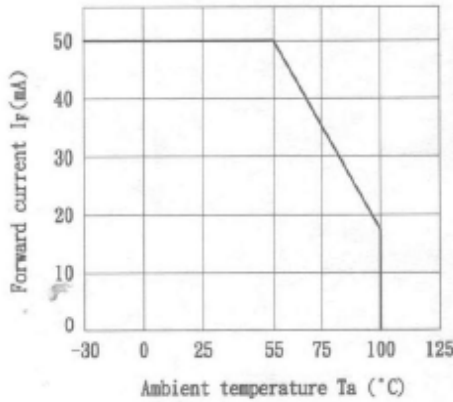

Fig.2 Diode Power Dissipation vs. Ambient Temperature

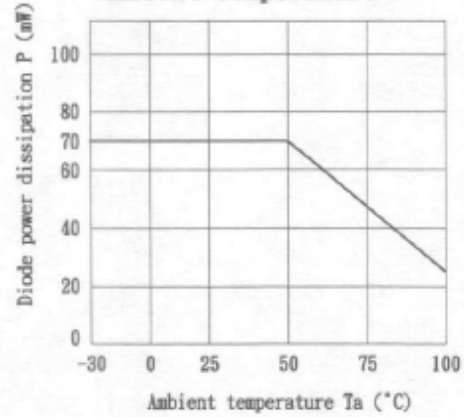

Fig.3 Collector Power Dissipation vs. Ambient Temperature

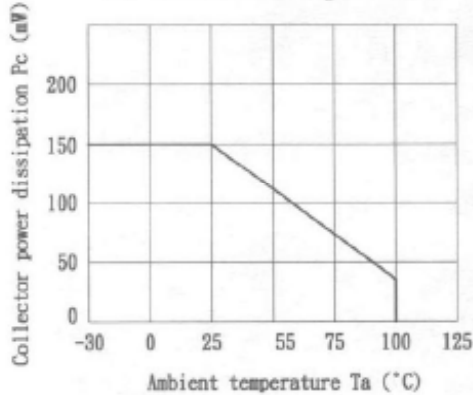

Fig.4 Total Power Dissipation vs. Ambient Temperature

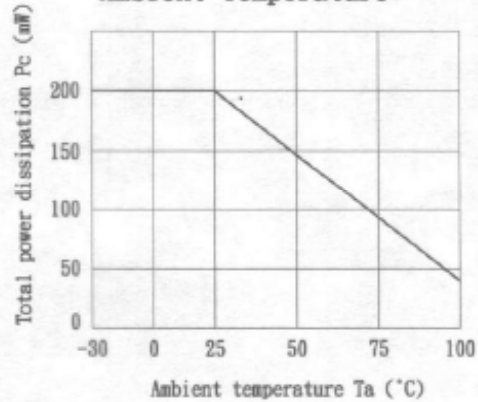

Fig.5 Peak Forward Current vs. Duty Ratio

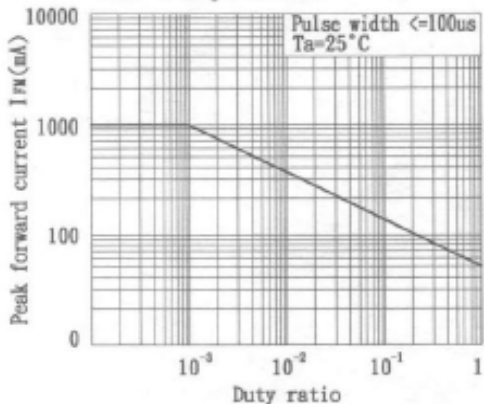
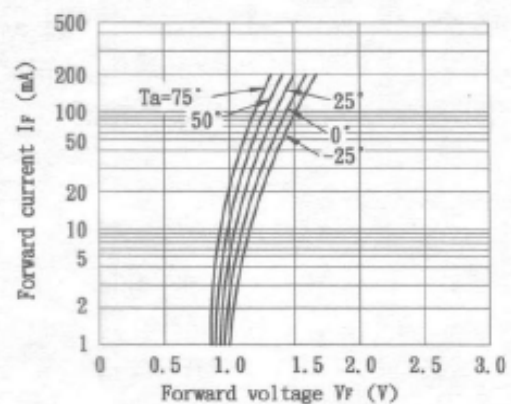

Fig.6 Forward Current vs. Forward Voltage



OPTEK reserves the right to make changes at any time in order to improve design and to supply the best product possible.

OPIA402

Fig. 7 Current Transfer Ratio vs. Forward Current

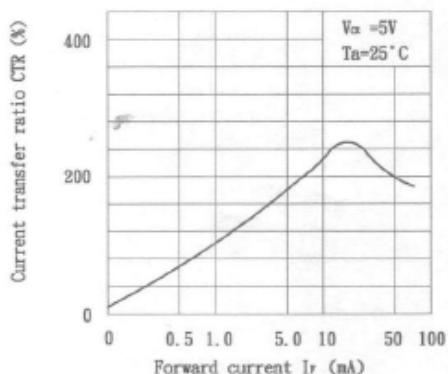

Fig. 8 Collector Current vs. Collector-emitter Voltage

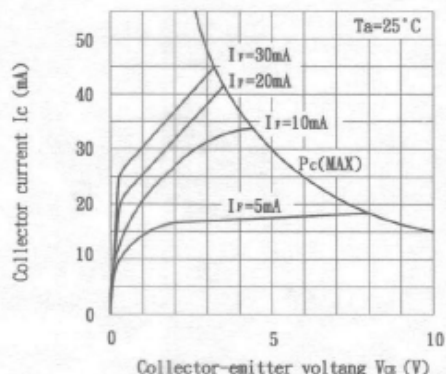

Fig. 9 Relative Current Transfer Ratio vs. Ambient Temperature

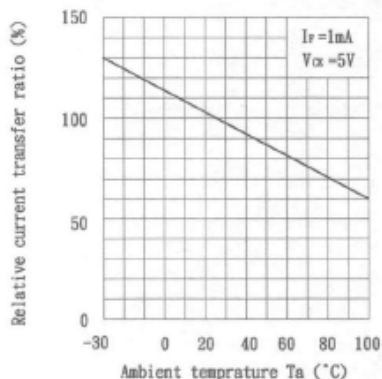

Fig. 10 Collector-emitter Saturation Voltage vs. Ambient Temperature

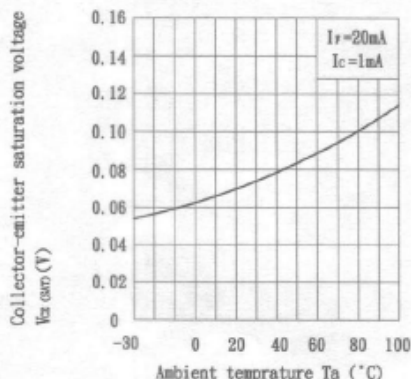

Fig. 11 Collector Dark Current vs. Ambient Temperature

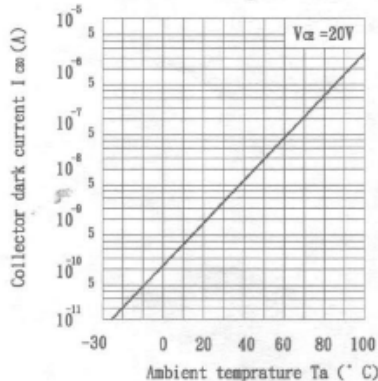
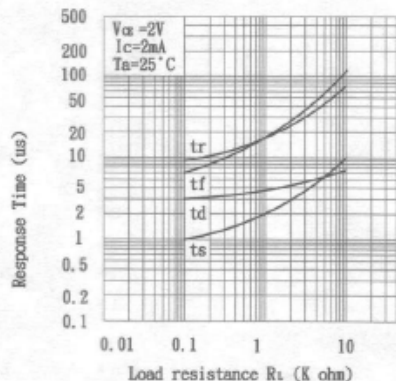

Fig. 12 Response Time vs. Load Resistance



OPTEK reserves the right to make changes at any time in order to improve design and to supply the best product possible.

OPIA403

Fig.1 Forward Current vs. Ambient Temperature

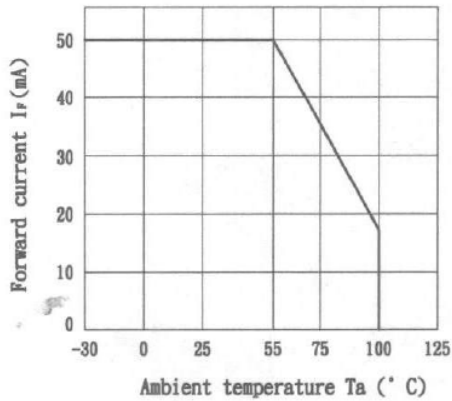

Fig.2 Collector Power Dissipation vs. Ambient Temperature

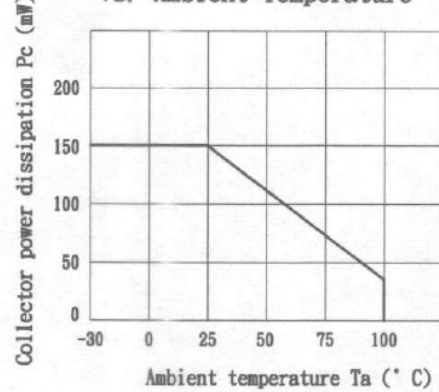

Fig.3 Peak Forward Current vs. Duty Ratio

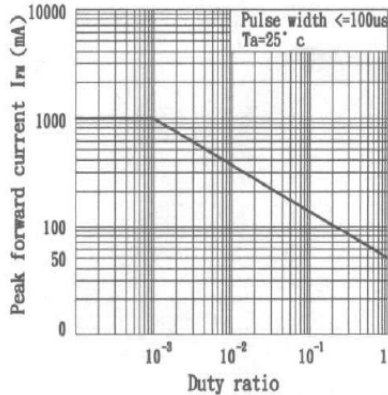

Fig.4 Forward Current vs. Forward Voltage

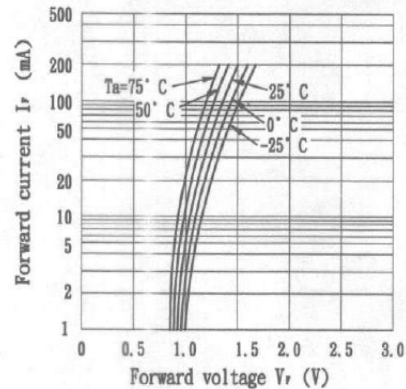

Fig.5 Current Transfer Ratio vs. Forward Current

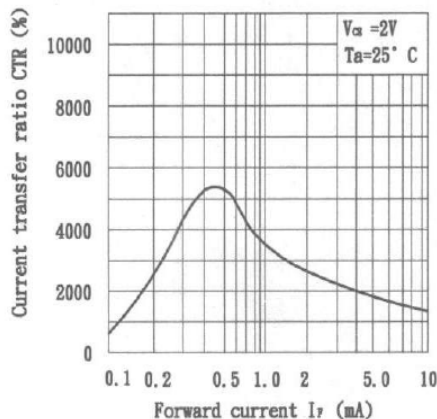
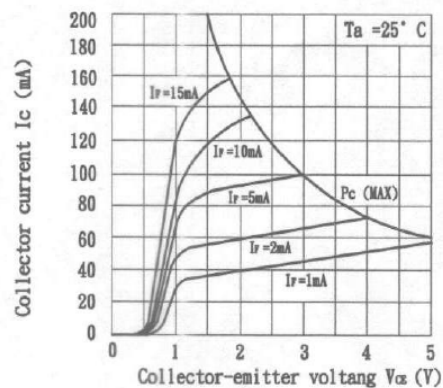

Fig.6 Collector Current vs. Collector-emitter Voltage



OPTEK reserves the right to make changes at any time in order to improve design and to supply the best product possible.



OPIA403

Fig.7 Relative Current Transfer Ratio vs. Ambient Temperature

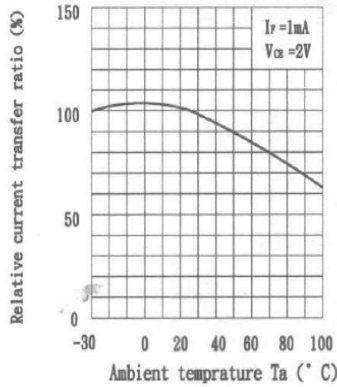

Fig.8 Collector-emitter Saturation Voltage vs. Ambient Temperature

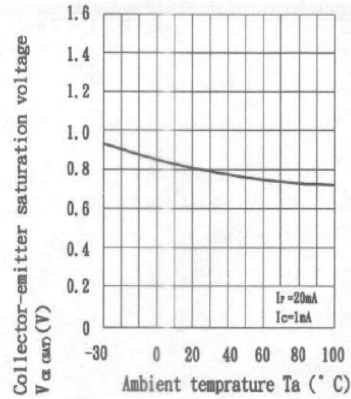

Fig.9 Collector Dark Current vs. Ambient Temperature

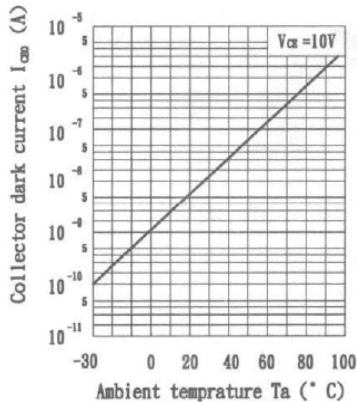

Fig.10 Response Time vs. Load Resistance

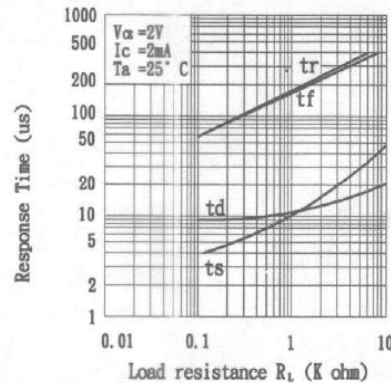
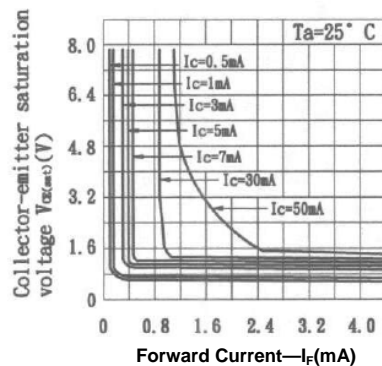

Fig.11 Collector-emitter Saturation Voltage vs. Forward Current



OPTEK reserves the right to make changes at any time in order to improve design and to supply the best product possible.

### OPIA404

Fig.1 Forward Current vs. Ambient Temperature

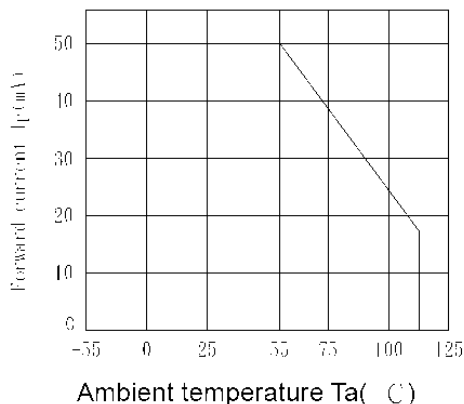

Fig.2 Diode Power Dissipation vs. Ambient Temperature

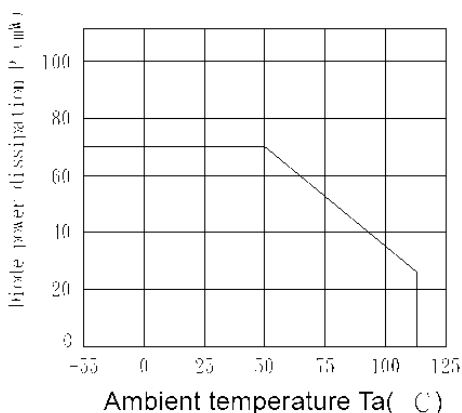

Fig.3 Collector Power Dissipation vs. Ambient Temperature

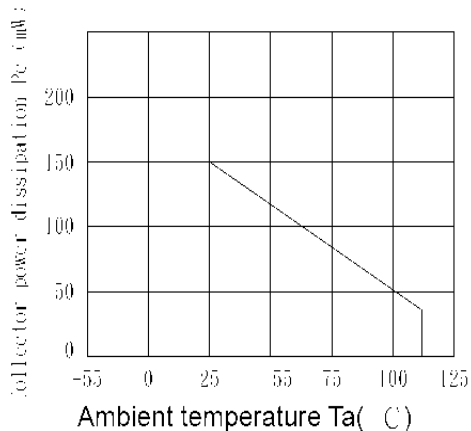

Fig.4 Total Power Dissipation vs. Ambient Temperature

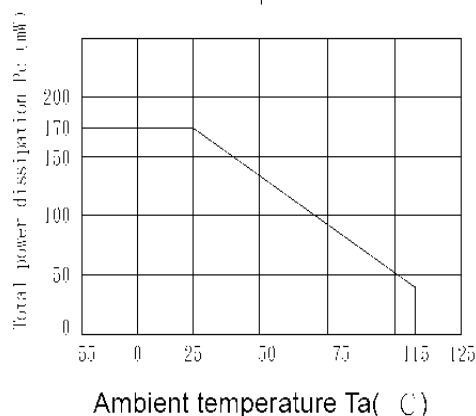

Fig.5 Peak Forward Current vs. Duty Ratio

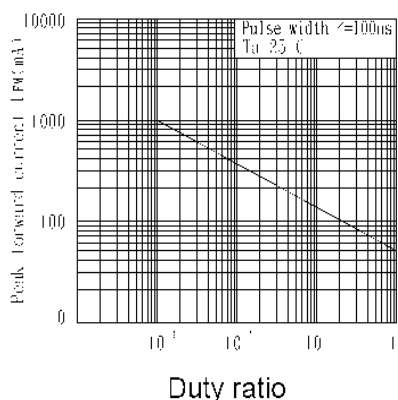
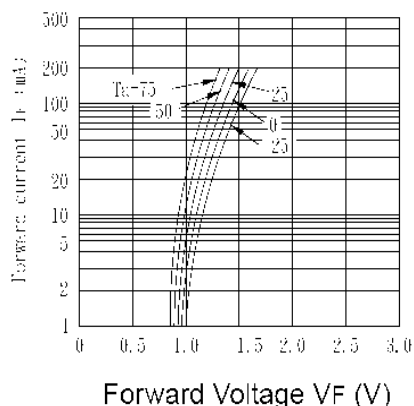

Fig.6 Forward Current vs. Forward Voltage



OPTEK reserves the right to make changes at any time in order to improve design and to supply the best product possible.

OPIA404

Fig.9 Collector Current vs. Collector-Emitter Voltage

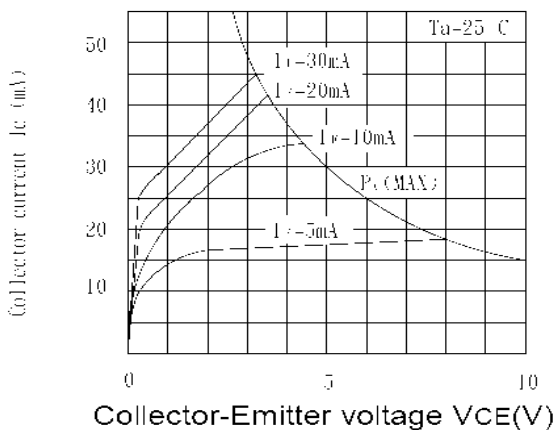

Fig.10 Relative Current Transfer Ratio vs. Ambient Temperature

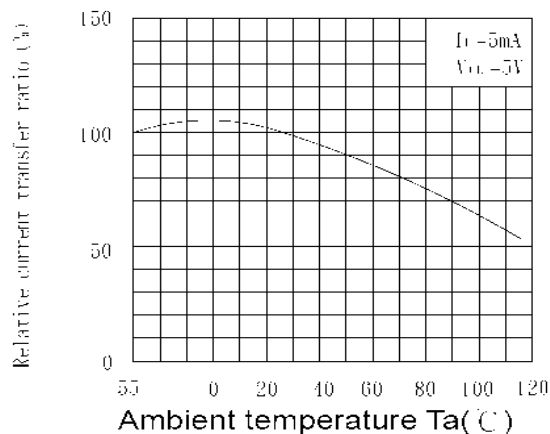

Fig.7 Forward Current vs. Forward Voltage

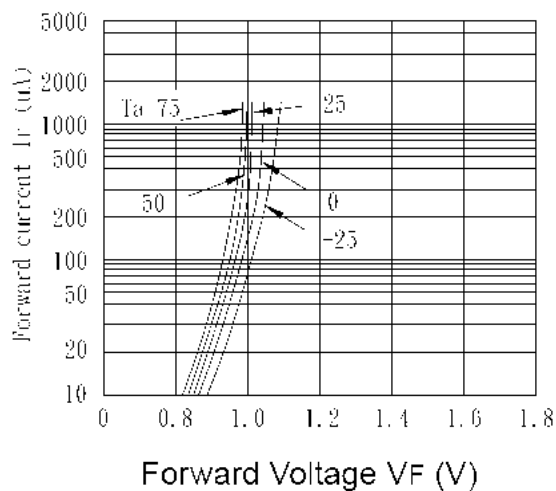
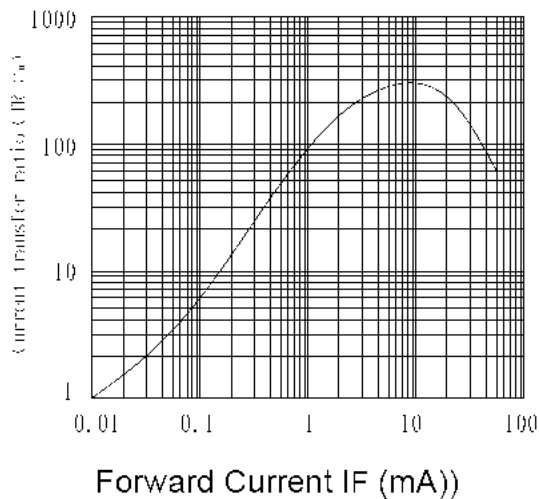

Fig.8 Current Transfer Ratio vs. Forward Current



OPTEK reserves the right to make changes at any time in order to improve design and to supply the best product possible.



### OPIA405

Fig. 1 Current Transfer Ratio vs. Forward Current

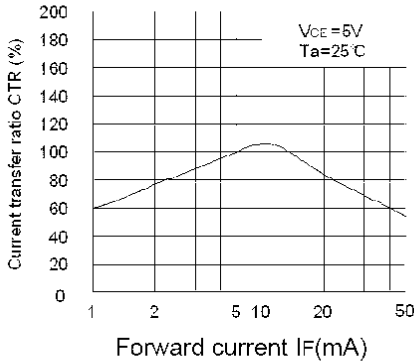

Fig.2 Collector Power Dissipation vs. Ambient Temperature

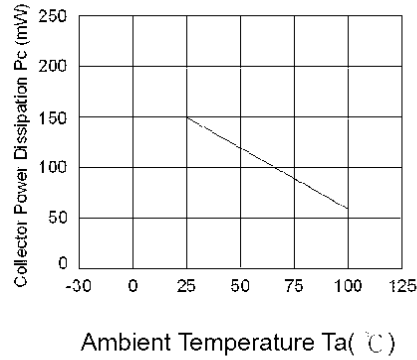

Fig.3 Collector Dark Current vs. Ambient Temperature

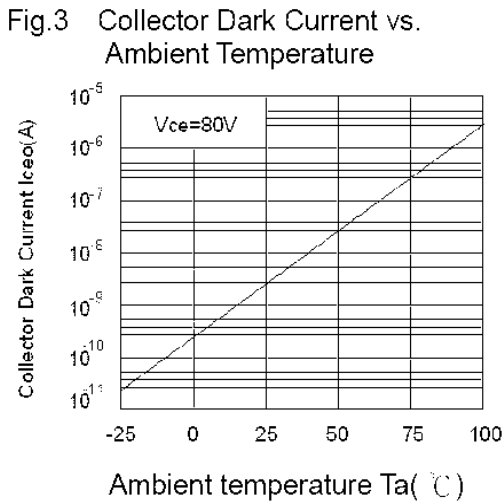

Fig.4 Forward Current vs. Ambient Temperature

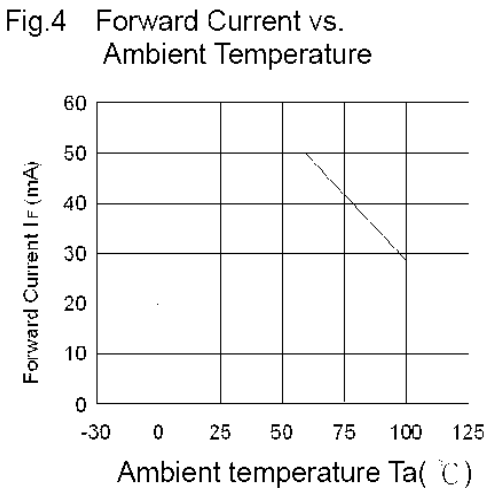

Fig.5 Forward Current vs. Forward Voltage

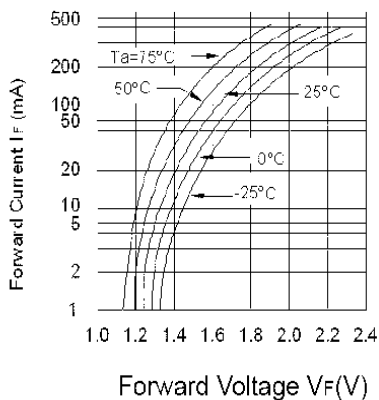
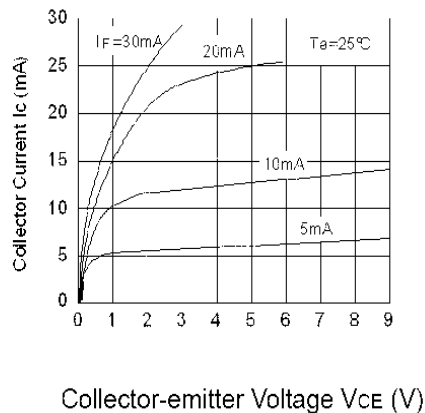

Fig.6 Collector Current vs. Collector-emitter Voltage



OPTEK reserves the right to make changes at any time in order to improve design and to supply the best product possible.

**OPIA405**

Fig.7 Collector-emitter Saturation Voltage vs. Ambient Temperature

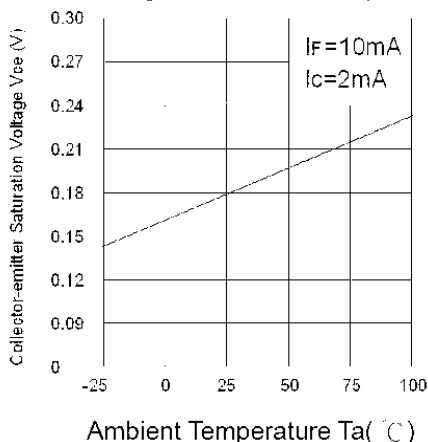

Fig.8 Collector-emitter Saturation Voltage vs. Forward Current

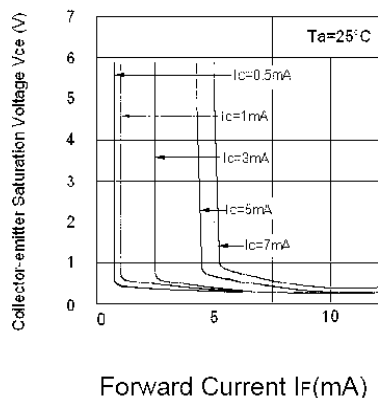

Fig.9 Response Time vs. Load Resistance Fig.10 Response Time vs. Load Resistance

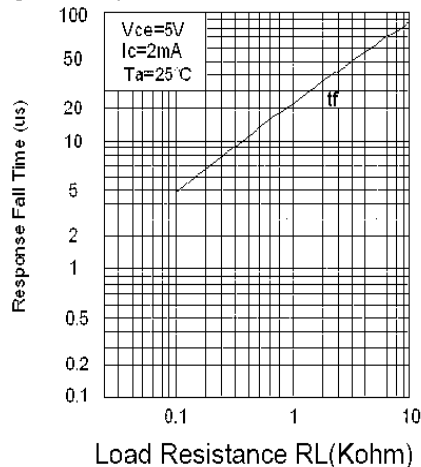
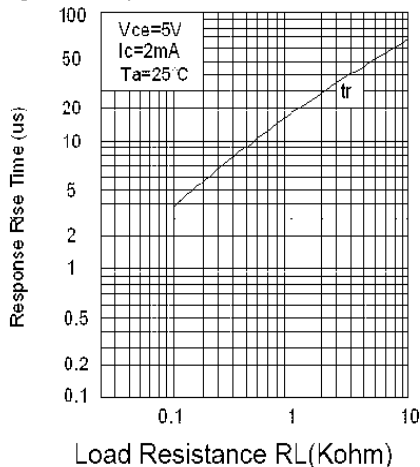
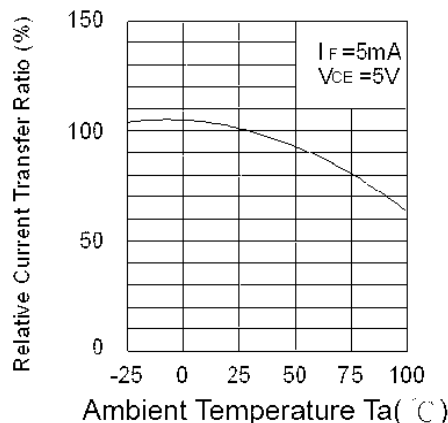

Fig.11 Relative Current Transfer Ratio vs. Ambient Temperature



OPTEK reserves the right to make changes at any time in order to improve design and to supply the best product possible.

### OPIA406

**Fig.1 Forward Current vs. Ambient Temperature**

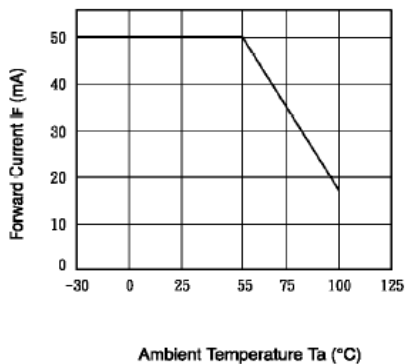

**Fig.2 Collector Power Dissipation vs. Ambient Temperature**

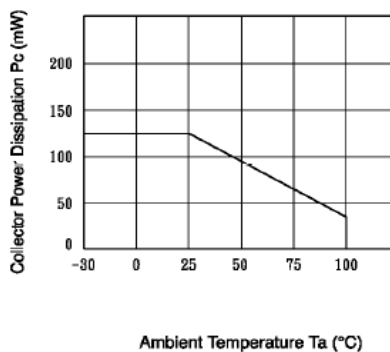

**Fig.3 Peak Forward Current vs. Duty Ratio**

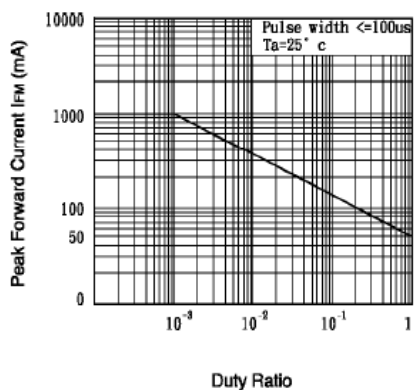

**Fig.4 Forward Current vs. Ambient Temperature**

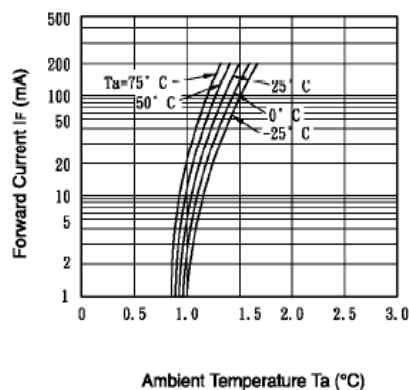

**Fig.5 Current Transfer Ratio vs. Forward Current**

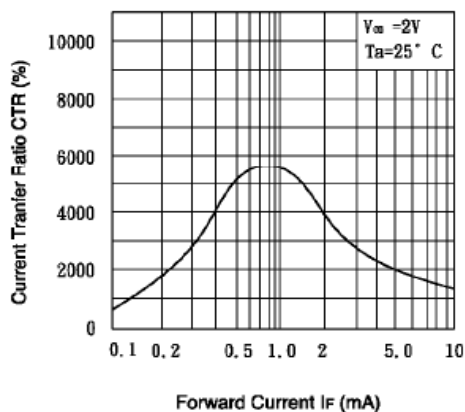

OPTEK reserves the right to make changes at any time in order to improve design and to supply the best product possible.

## OPIA406

**Fig.6** Collector Current vs. Collector-emitter Voltage

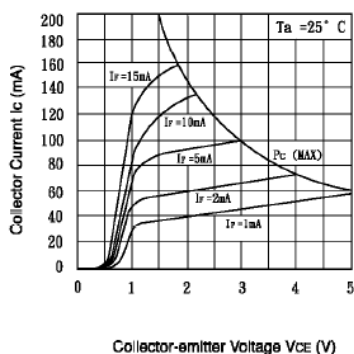

**Fig.7** Relative Current Transfer Ratio vs. Ambient Temperature

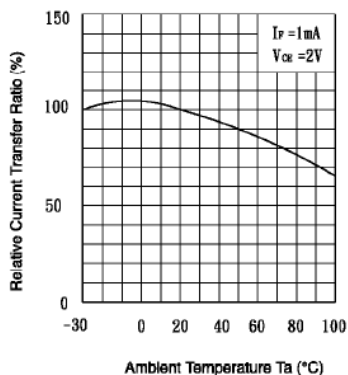

**Fig.8** Collector-emitter Saturation Voltage vs. Ambient Temperature

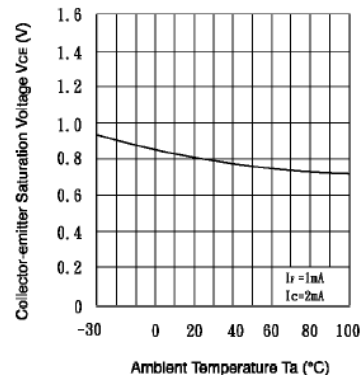

**Fig.9** Collector Dark Current vs. Ambient Temperature

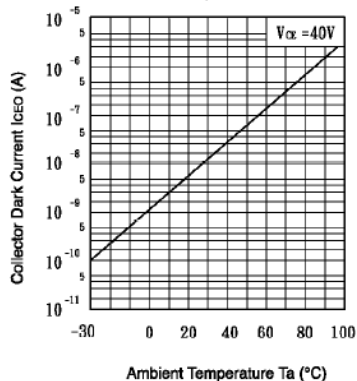

**Fig.10** Response Time vs. Load Resistance

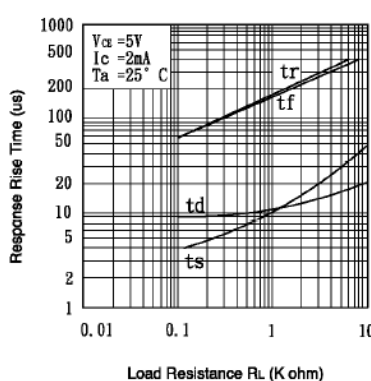

**Fig.11** Collector-emitter Saturation Voltage vs. Forward Current

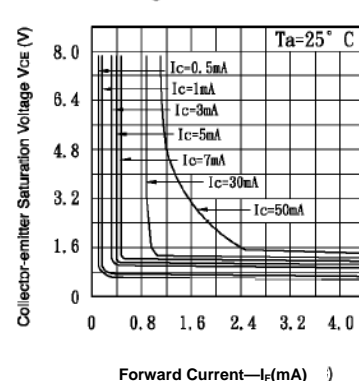

OPTEK reserves the right to make changes at any time in order to improve design and to supply the best product possible.

OPIA407

Fig.1 Current Transfer Ratio vs. Forward Current

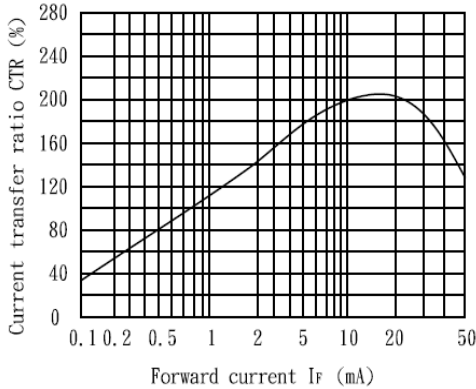

Fig.2 Collector Power Dissipation vs. Ambient Temperature

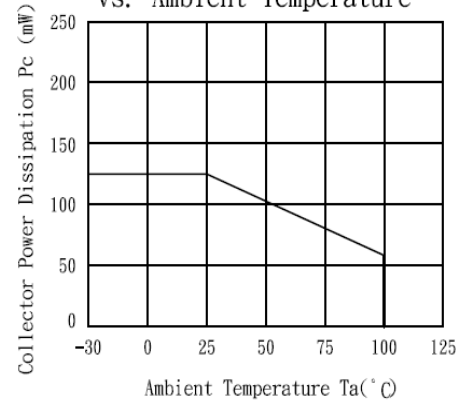

Fig.3 Collector Dark Current vs. Ambient Temperature

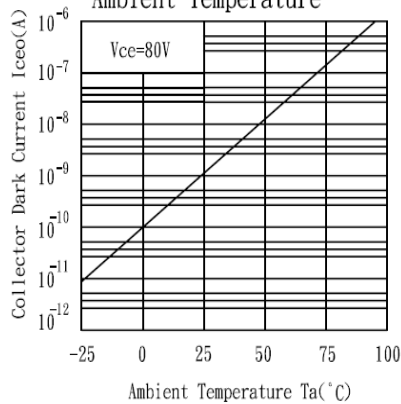

Fig.4 Forward Current vs. Ambient Temperature

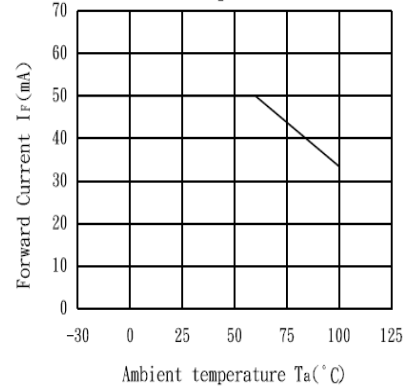

Fig.5 Forward Current vs. Forward Voltage

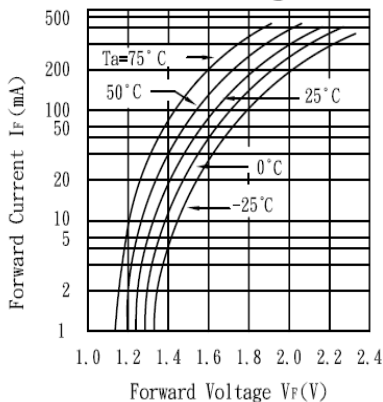
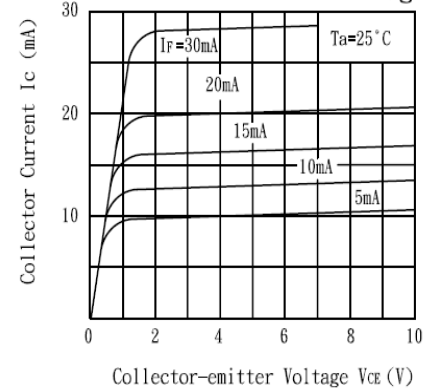

Fig.6 Collector Current vs. Collector-emitter Voltage



OPTeK reserves the right to make changes at any time in order to improve design and to supply the best product possible.

### OPIA407

Fig. 7 Collector-emitter Saturation Voltage vs. Ambient Temperature

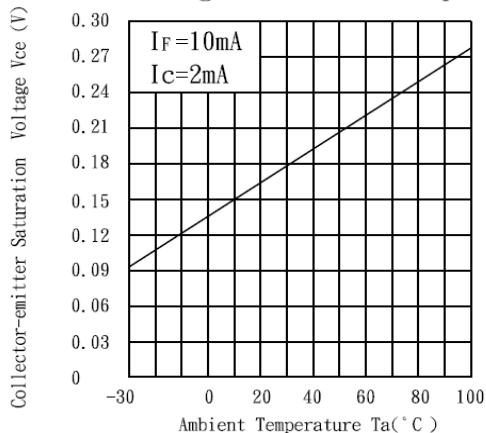

Fig. 8 Collector-emitter Saturation Voltage vs. Forward Current

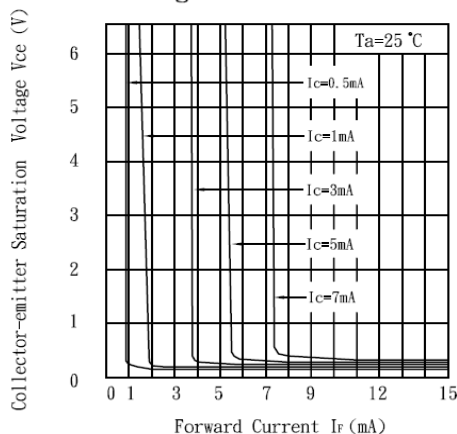

Fig. 9 Response Time vs. Load Resistance

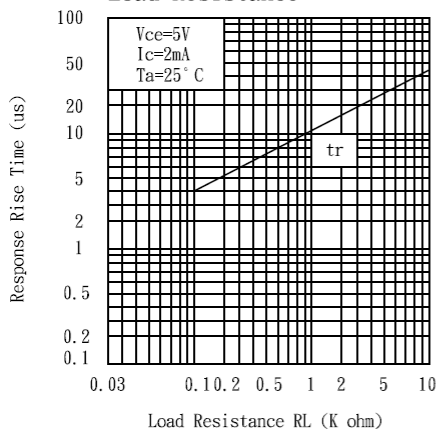

Fig. 10 Response Time vs. Load Resistance

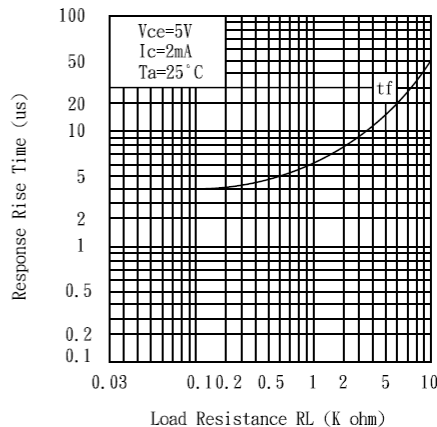
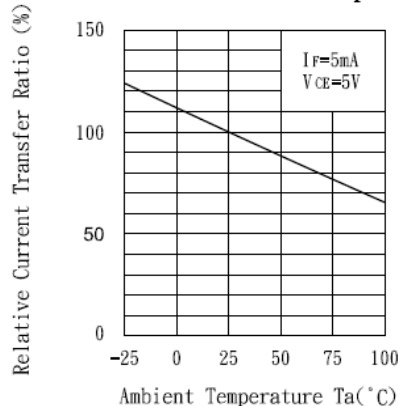
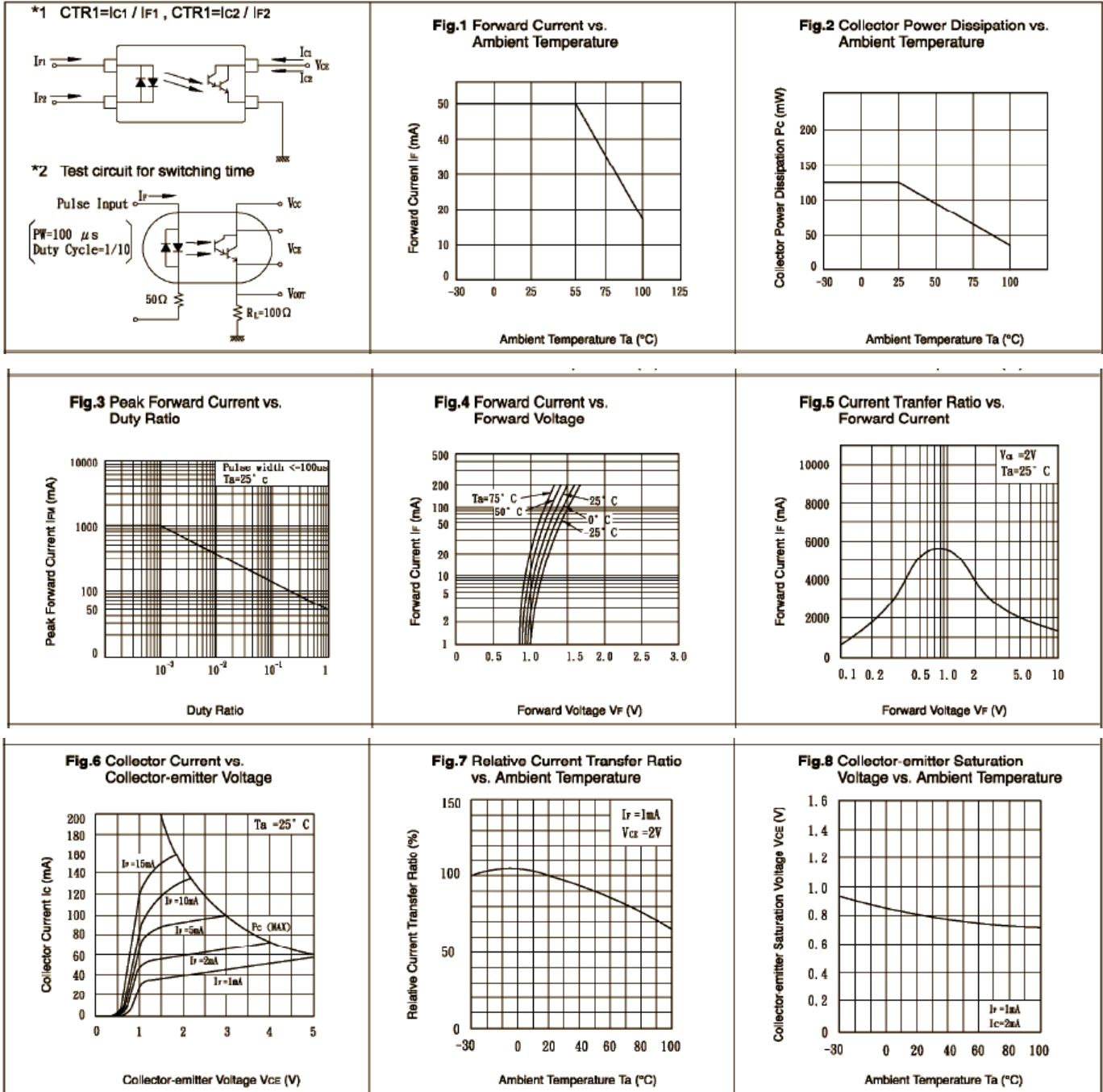

Fig. 11 Relative Current Transfer Ratio vs. Ambient Temperature



OPTEK reserves the right to make changes at any time in order to improve design and to supply the best product possible.

## OPIA408



OPTeK reserves the right to make changes at any time in order to improve design and to supply the best product possible.

OPIA408

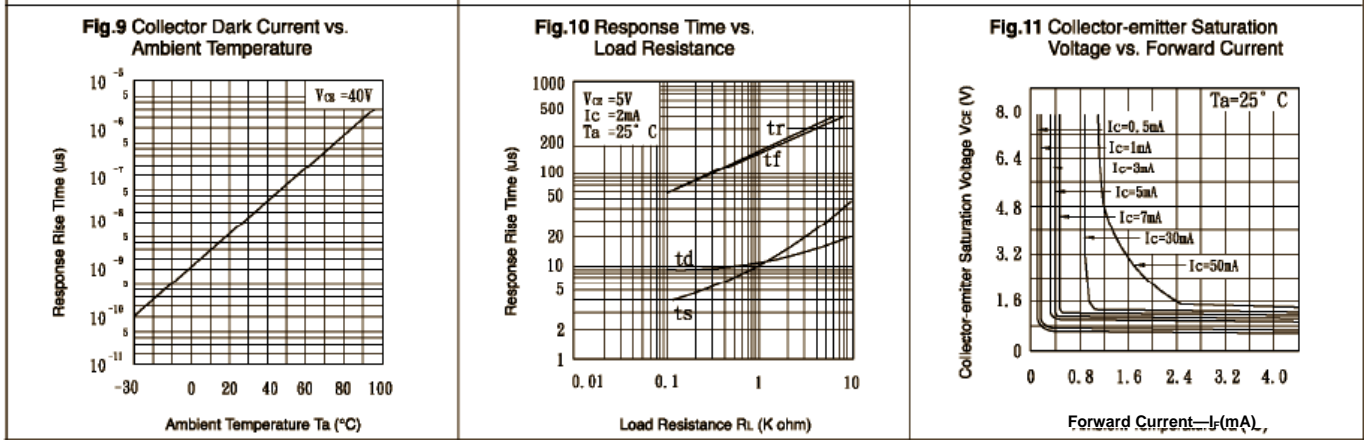

OPTEK reserves the right to make changes at any time in order to improve design and to supply the best product possible.



### OPIA409

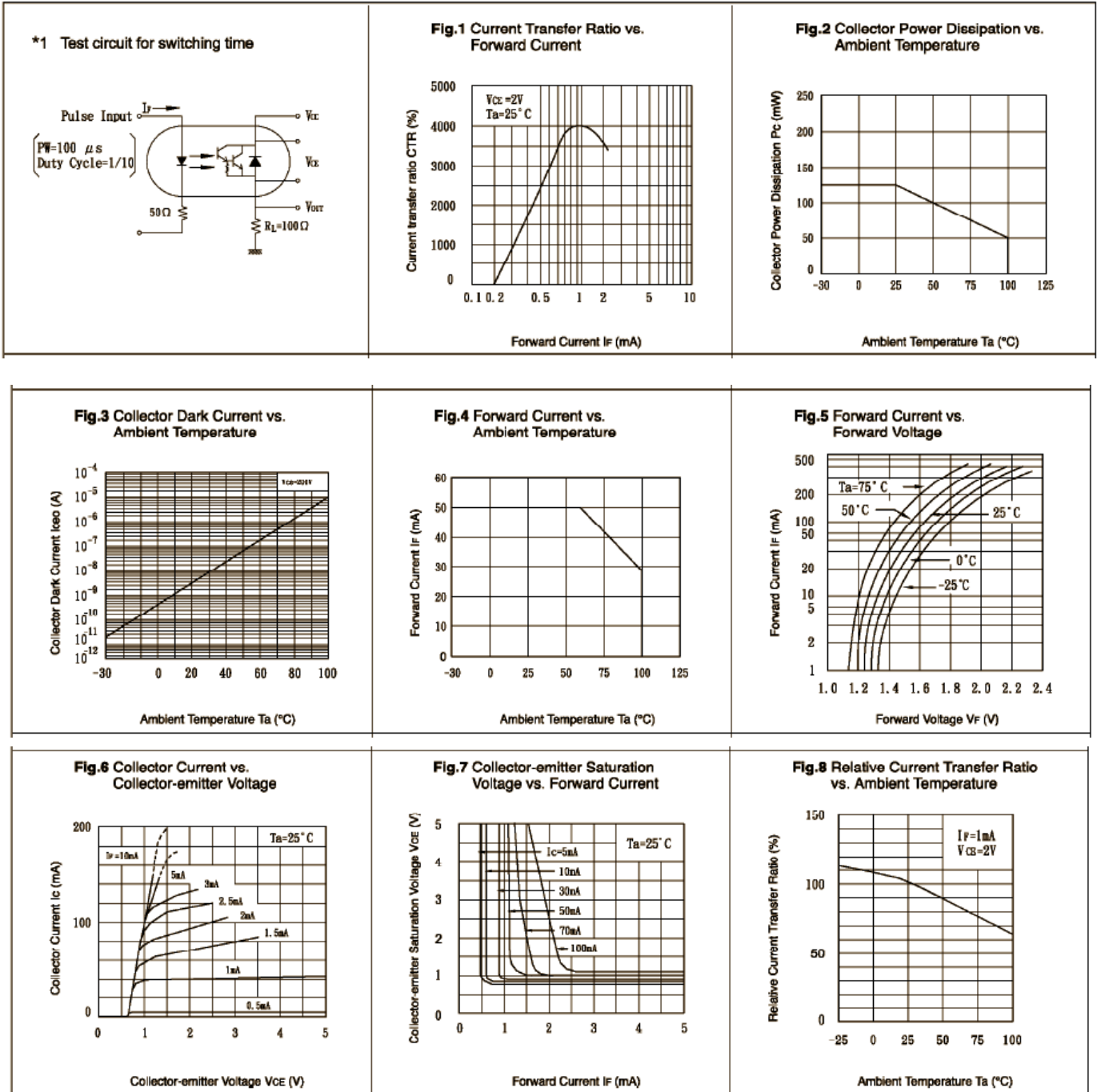

OPTEK reserves the right to make changes at any time in order to improve design and to supply the best product possible.

OPIA409

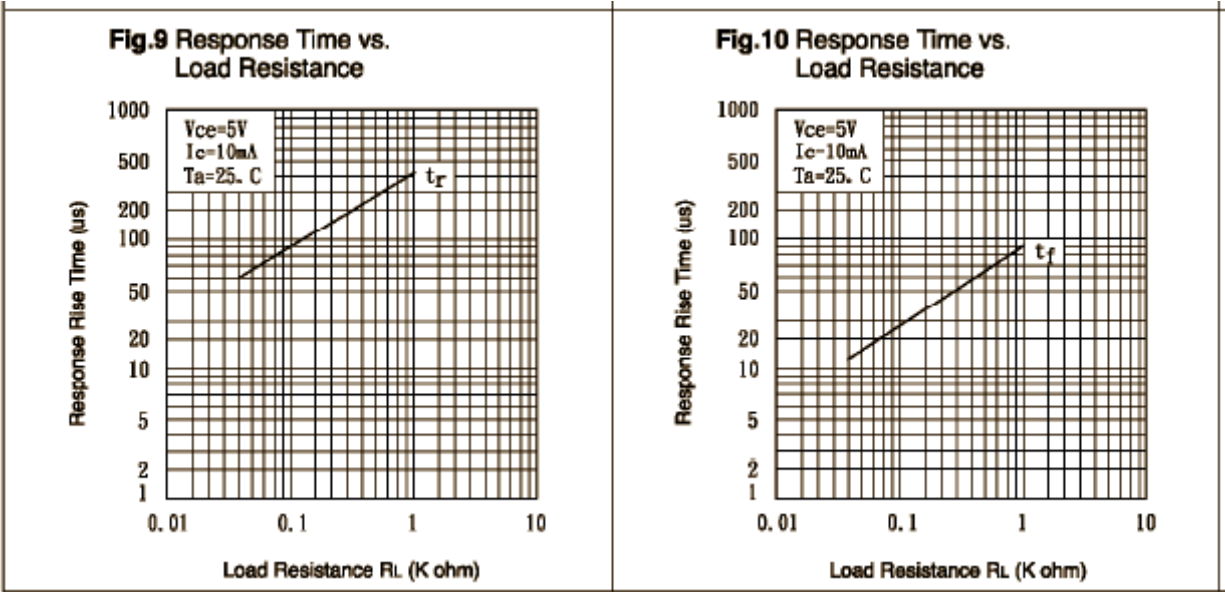

OPTEK reserves the right to make changes at any time in order to improve design and to supply the best product possible.

### OPIA410

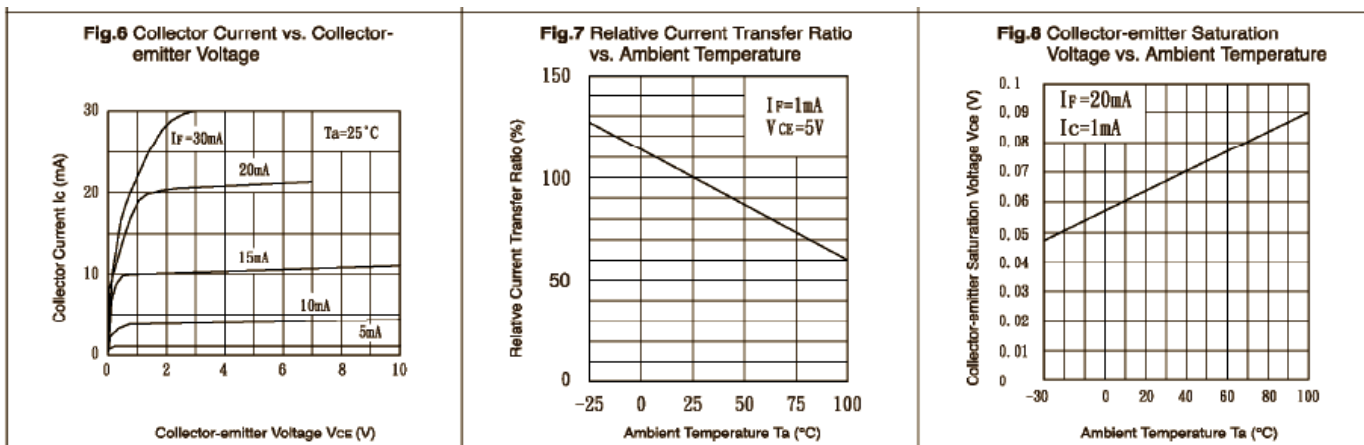
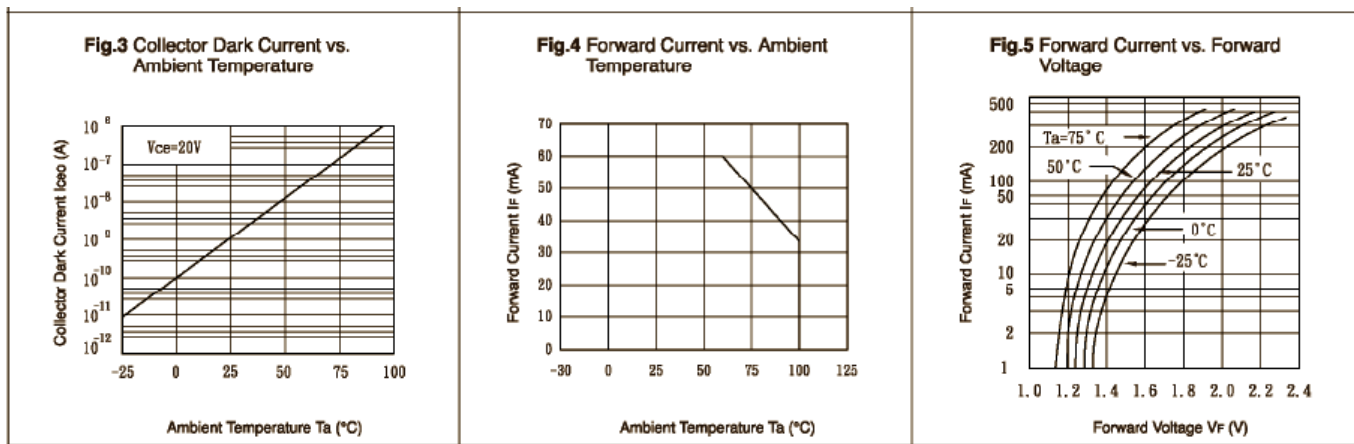
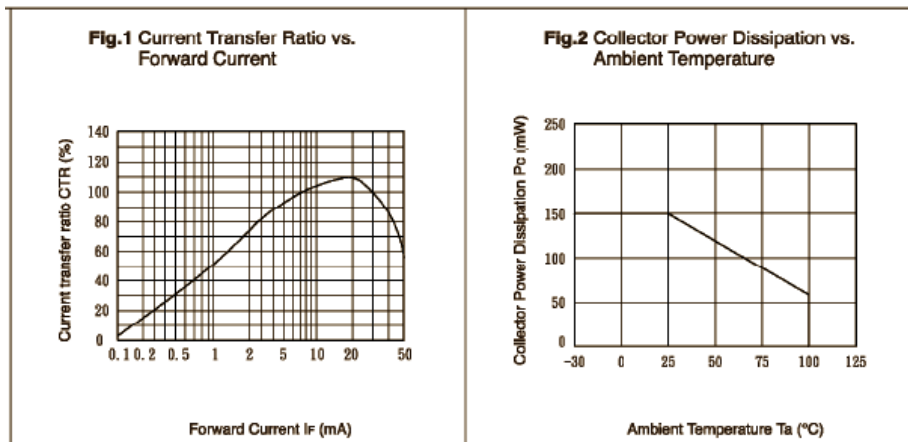

OPTEK reserves the right to make changes at any time in order to improve design and to supply the best product possible.

### OPIA410

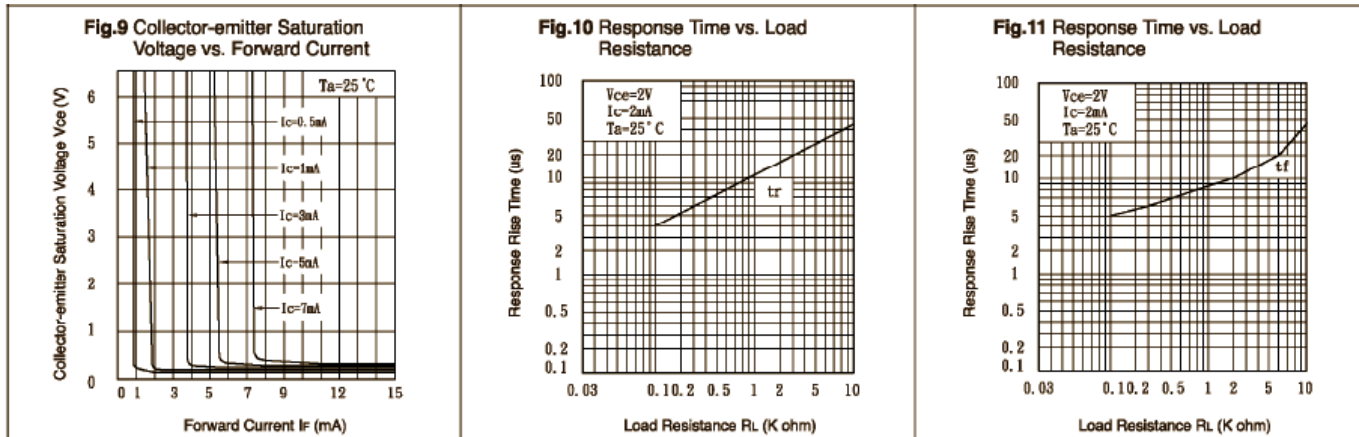

OPTEK reserves the right to make changes at any time in order to improve design and to supply the best product possible.

OPIA411

Fig. 1 Forward Current vs. Ambient Temperature

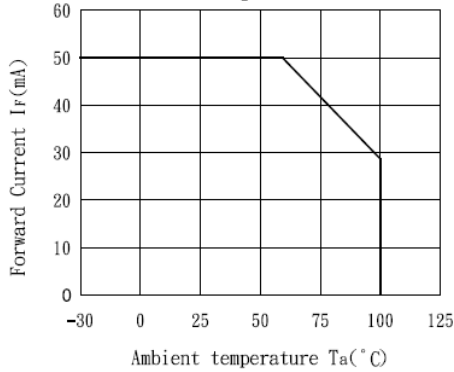

Fig. 2 Collector Power Dissipation vs. Ambient Temperature

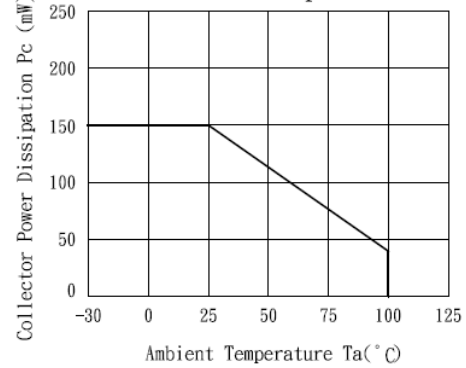

Fig. 3 Collector-emitter Saturation Voltage vs. Forward Current

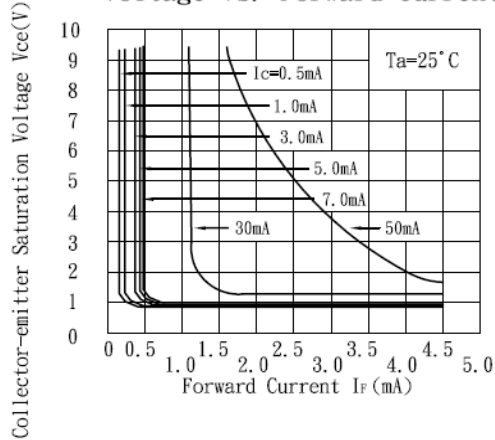

Fig. 4 Forward Current vs. Forward Voltage

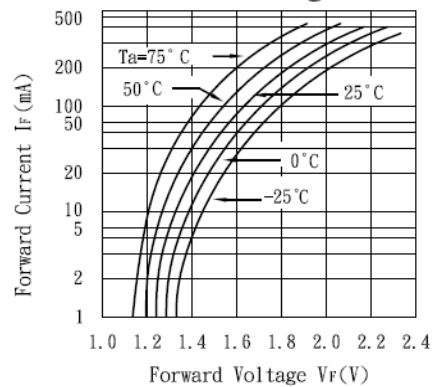

Fig. 5 Current Transfer Ratio vs. Forward Current

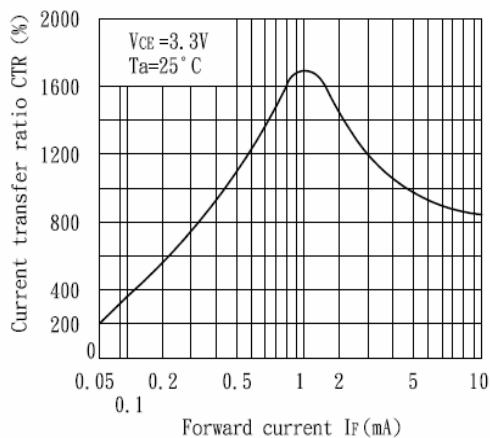
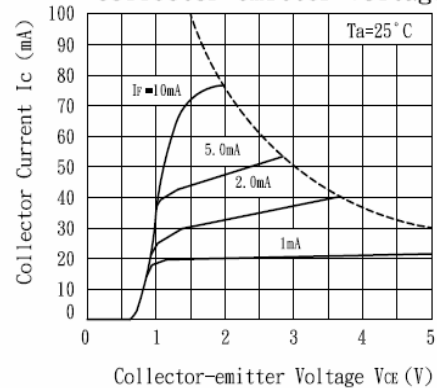

Fig. 6 Collector Current vs. Collector-emitter Voltage



OPTEK reserves the right to make changes at any time in order to improve design and to supply the best product possible.

OPIA411

Fig. 7 Relative Current Transfer Ratio vs. Ambient Temperature

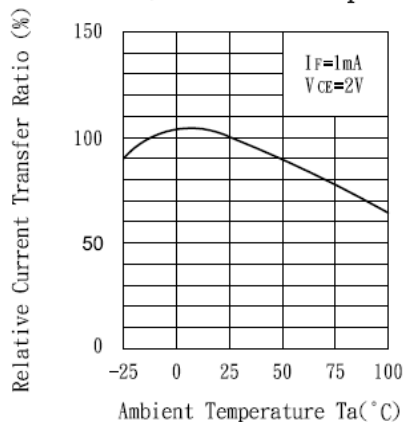

Fig. 7 Collector-emitter Saturation Voltage vs. Ambient Temperature

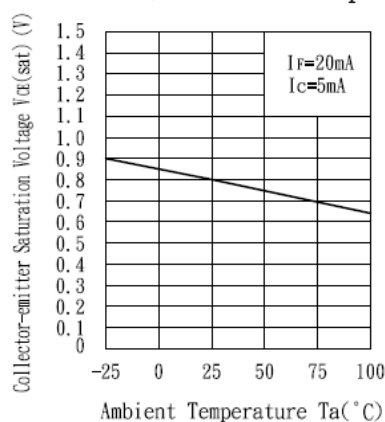

Fig. 9 Collector Dark Current vs. Ambient Temperature

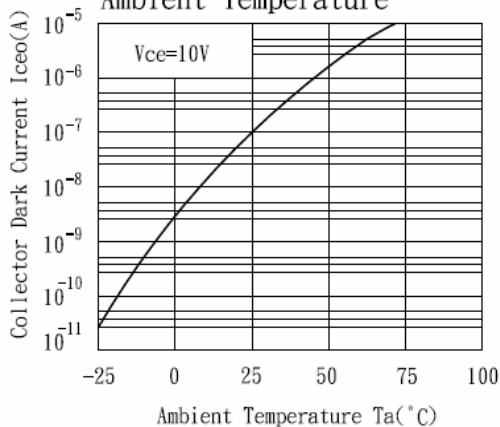
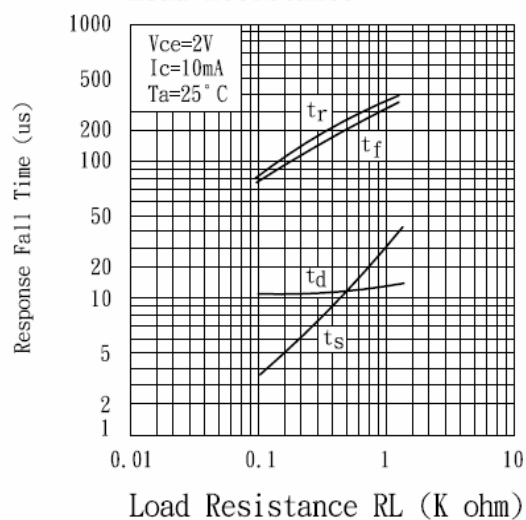

Fig. 10 Response Time vs. Load Resistance



OPTEK reserves the right to make changes at any time in order to improve design and to supply the best product possible.

OPIA412

Fig. 4 Forward Current vs. Ambient Temperature

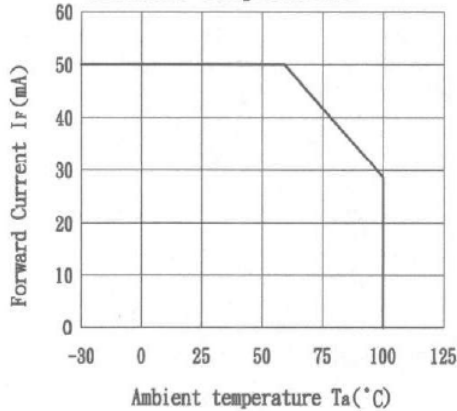

Fig. 5 Forward Current vs. Forward Voltage

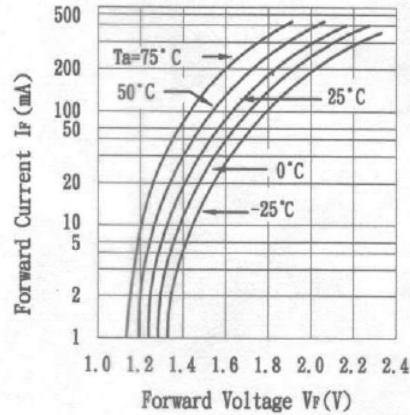

Fig. 2 Collector Power Dissipation vs. Ambient Temperature

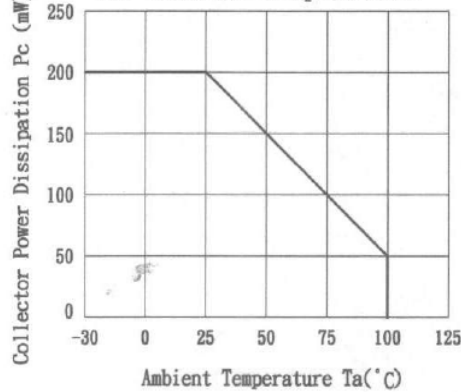

Fig. 3 Collector Dark Current vs. Ambient Temperature

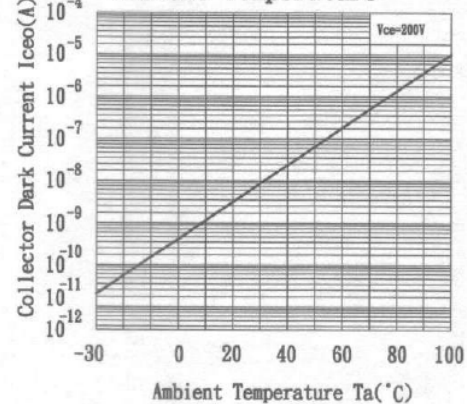

Fig. 6 Collector Current vs. Collector-emitter Voltage

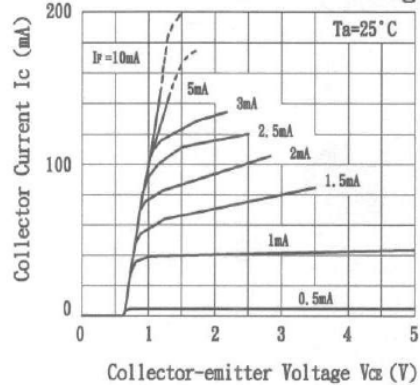
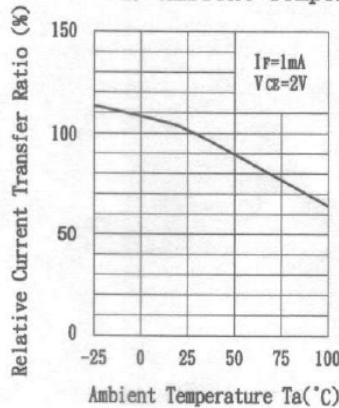

Fig. 7 Relative Current Transfer Ratio vs. Ambient Temperature



OPTeK reserves the right to make changes at any time in order to improve design and to supply the best product possible.



OPIA412

Fig. 8 Collector-emitter Saturation Voltage vs. Forward Current

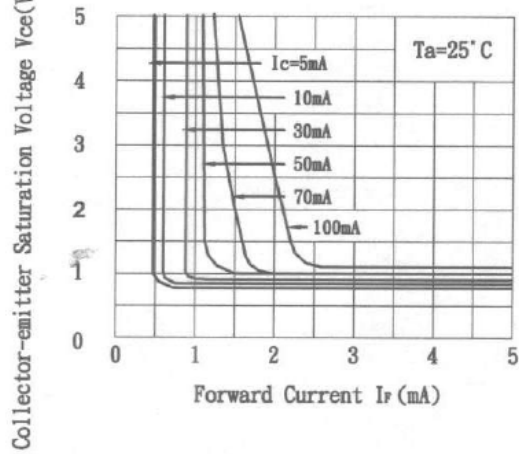
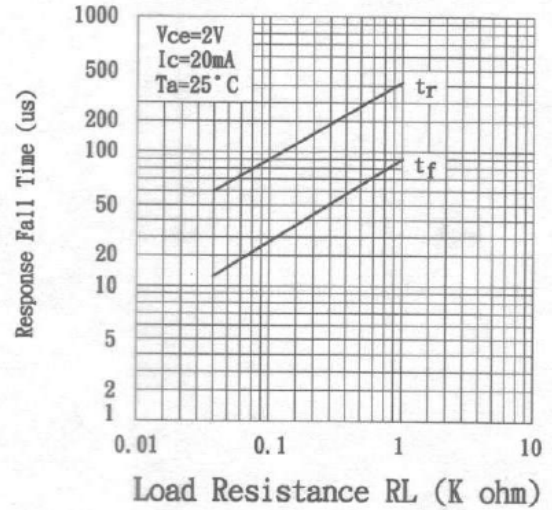

Fig. 9 Response Time vs. Load Resistance



OPTEK reserves the right to make changes at any time in order to improve design and to supply the best product possible.



OPIA413

Fig. 1 Current Transfer Ratio Vs. Forward Current

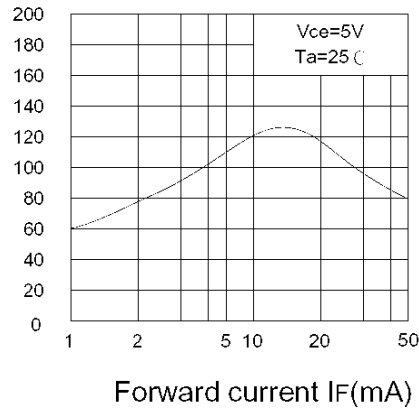

Fig.10 Response Time vs. Load Resistance

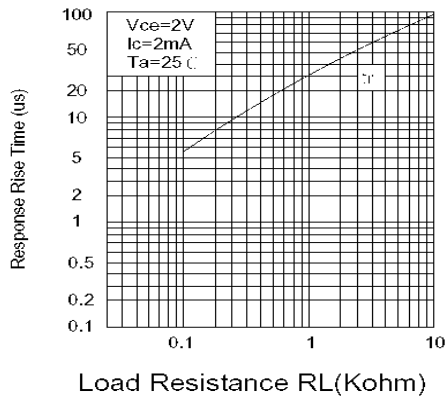

Fig.11 Response Time vs. Load Resistance

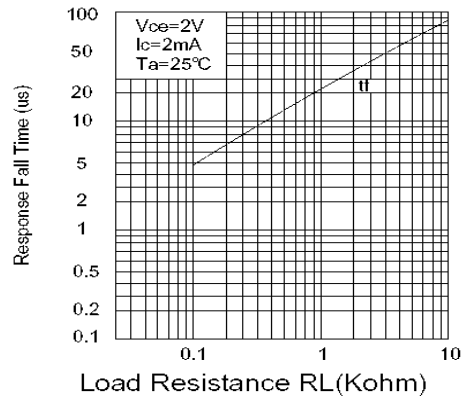

Fig.8 Collector-emitter Saturation Voltage vs. Ambient Temperature

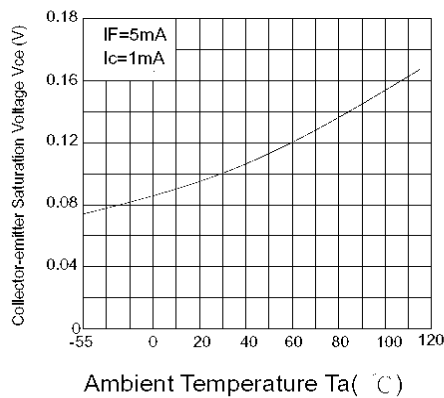
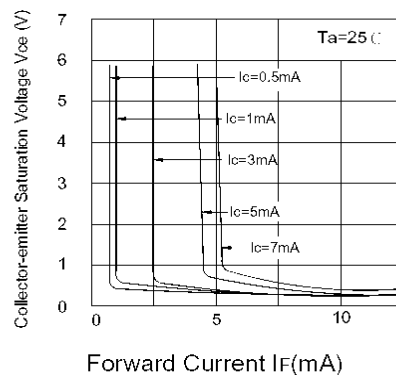

Fig.9 Collector-emitter Saturation Voltage vs. Forward Current



OPTEK reserves the right to make changes at any time in order to improve design and to supply the best product possible.

OPIA413

Fig.4 Forward Current vs. Ambient Temperature

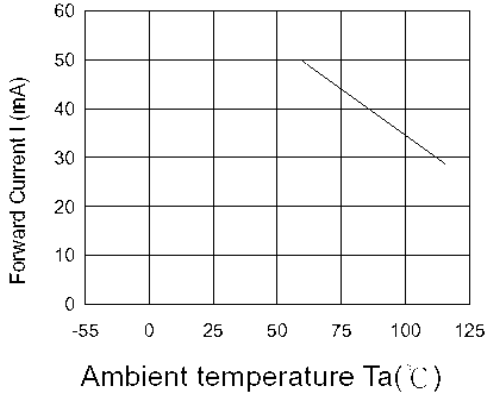

Fig.5 Forward Current vs. Forward Voltage

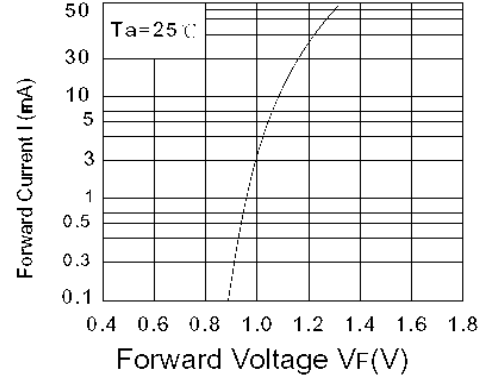

Fig.6 Collector Current vs. Collector-emitter Voltage

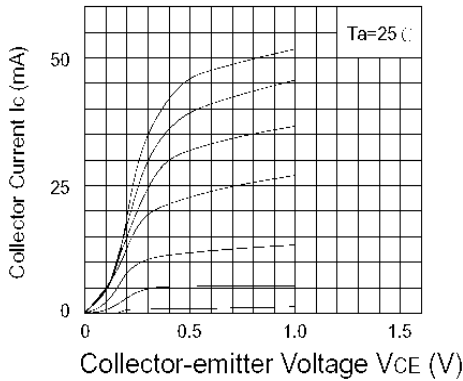

Fig.7 Relative Current Transfer Ratio vs. Ambient Temperature

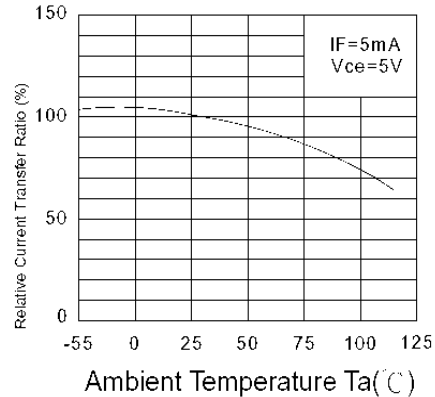

Fig.2 Collector Power Dissipation vs. Ambient Temperature

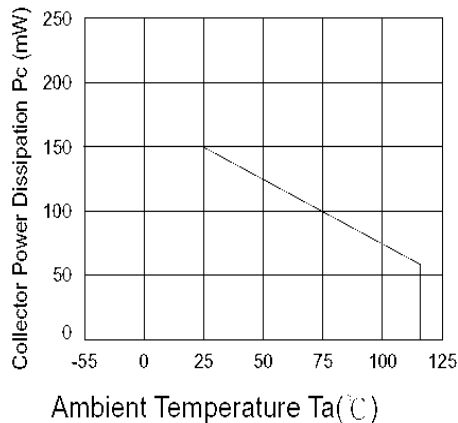
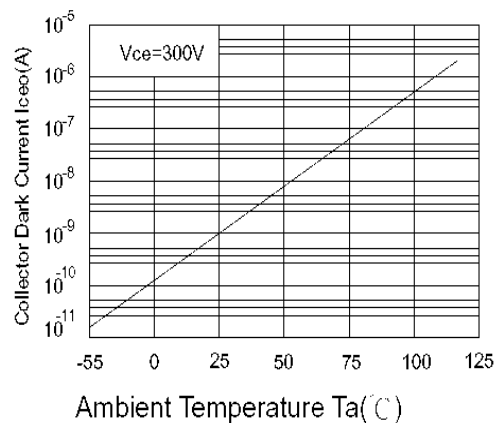

Fig.3 Collector Dark Current vs. Ambient Temperature



OPTEK reserves the right to make changes at any time in order to improve design and to supply the best product possible.

OPIA414

Fig.1 Current Transfer Ratio vs. Forward Current

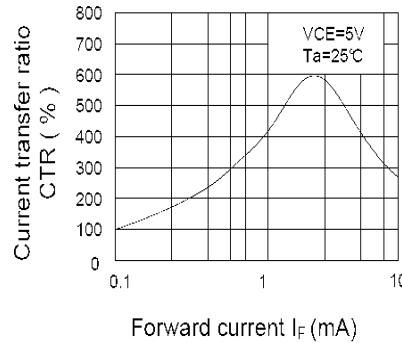

Fig.2 Collector Power Dissipation vs. Ambient Temperature

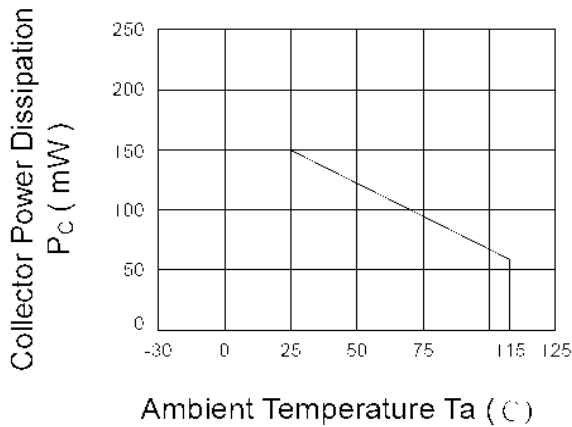

Fig.3 Collector Dark Current vs. Ambient Temperature

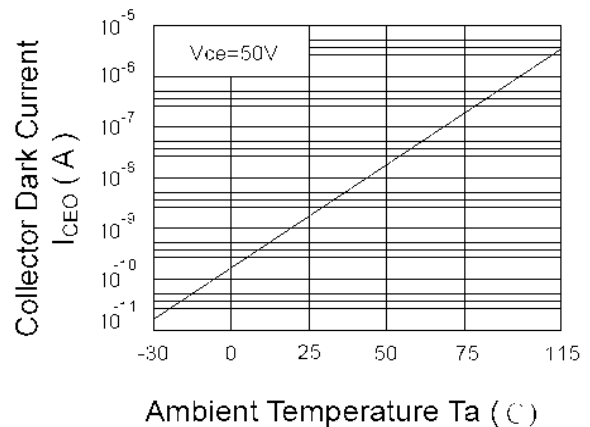

Fig.4 Forward Current vs. Ambient Temperature

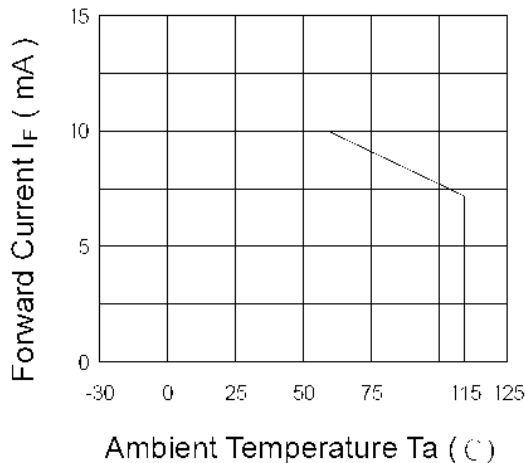
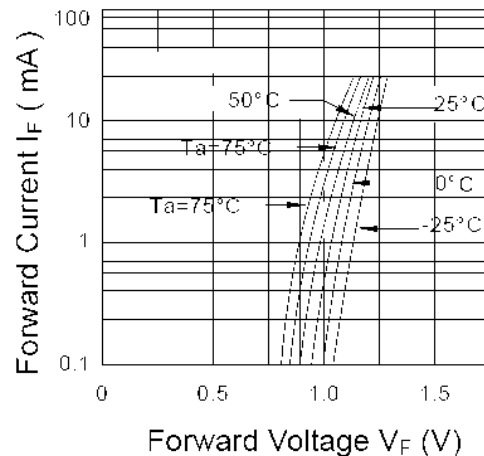

Fig.5 Forward Current vs. Forward Voltage



OPTEK reserves the right to make changes at any time in order to improve design and to supply the best product possible.

OPIA414

Fig.6 Collector Current vs. Collector-Emitter Voltage

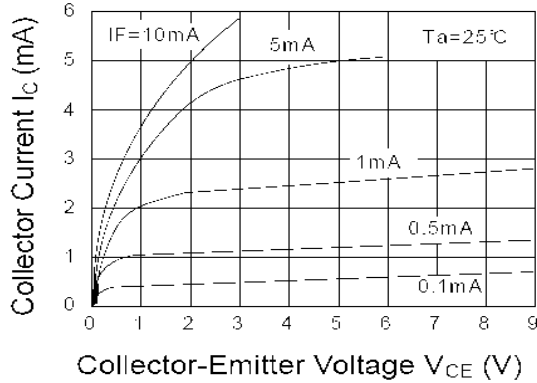

Fig.7 Relative Current Transfer Ratio vs. Ambient Temperature

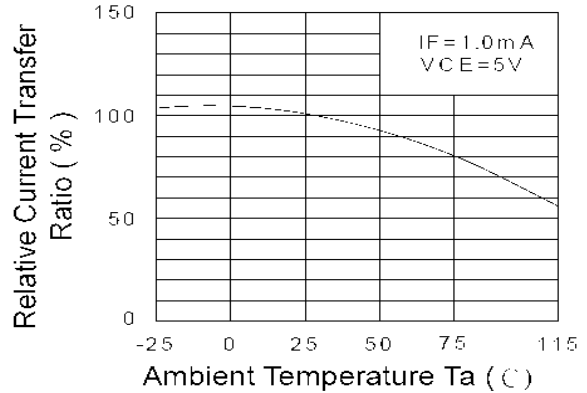

Fig.8 Collector-Emitter Saturation Voltage vs. Ambient Temperature

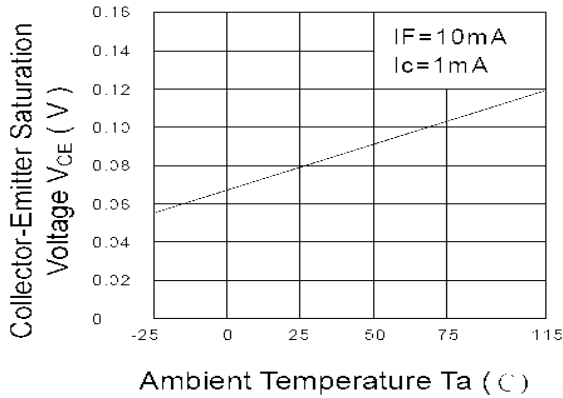

Fig.9 Collector-Emitter Saturation Voltage vs. Forward Current

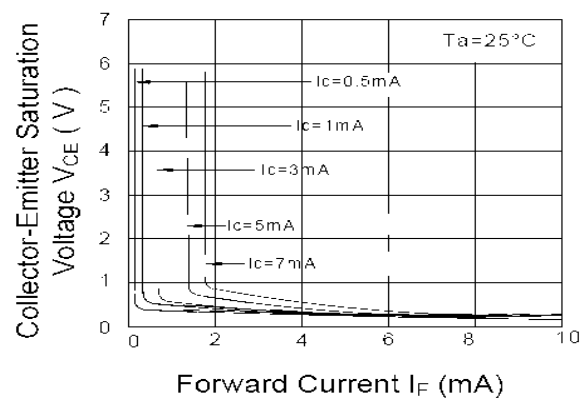

Fig.10 Response Time vs. Load Resistance

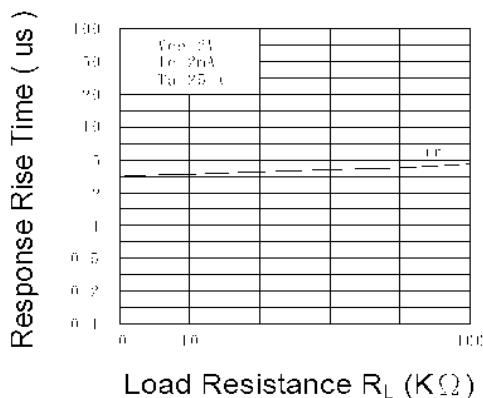
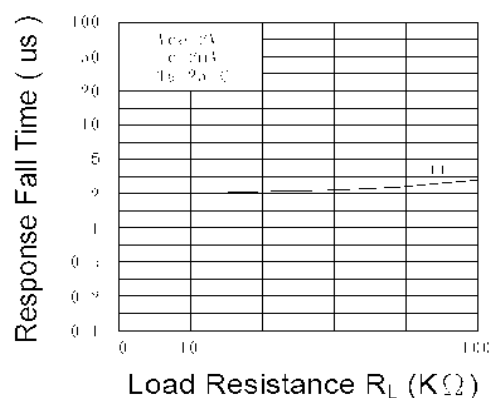

Fig.11 Response Time vs. Load Resistance



OPTEK reserves the right to make changes at any time in order to improve design and to supply the best product possible.

**Quality / Reliability Requirements**

Parameter	Failure Criteria	Conditions
HTRB D I <sub>C(OFF)</sub>	± 10%	11 samples after 500Hrs
	0 Fail	@ VCE = 5.0VDC, Ta = 70°C
HTFB D I <sub>C(ON)</sub>	± 10%	50 samples after 96Hrs
	0 Fail	@ Max P <sub>D</sub> , Ta = 25°C
MTTF @ 90% confidence	150,000 Min.	@ 25°C, 25mADC
Moisture Sensitivity Level	MSL 1	per JDEC std J-STD-020B
Lead Solderability	0 Fail	per Method 208 of MIL-STD-202.
Glass Transition of body	125°C Min.	DSC test method
Temperature Humidity-Bias	± 20%	85°C, 85%RH, 500Hrs, 80% min I <sub>ceo</sub>
Temperature Cycle	± 20%	per Method 1010.7 of MIL-STD-883E
High Temperature Storage	± 20%	85°C, 500Hrs
Autoclave	0 Fail	T <sub>A</sub> = 121°C, Pressure = 15psi, Humidity = 100%, Time = 96Hrs

**Note:** This is to be performed when a change occurs to form, fit or function.

**Government and Industry Standard  
Compliance Requirements**

European Union’s Reduction of Hazardous Substances (RoHS) Directive 2002/95/EC







**Label Identification**

**DESCRIPTION:**

Size: 3” (7.4 cm) X 2.2” (5.5 cm)  
 Lettering shall be black on white background.  
 Format shall be as:

**Notes:**

1. The DATE CODE is a 4-digit code for date of manufacture where YY is the last two digits of the year, and WW is week number of manufacture.
2. The LOT I.D. is the manufacturing location lot identification where Y is the year of manufacture, NNNN is a sequential lot identifier, and DDD is the day of the year of manufacture. – or use equivalent label format.

 Carrollton, TX, USA MADE IN TAIWAN 
OPTEK P/N <u>  OPIA407C-TR  </u> 
QTY. <u>  N/A  </u> 
DATE CODE <u>  (Y Y W W)  </u> 
LOT I.D. <u>  (Y - N N N N D D D)  </u> 

OPTEK reserves the right to make changes at any time in order to improve design and to supply the best product possible.

# Optocoupler—SMD, SOP and SSOP Packages OPIA400 through OPIA414



## Tube Packaging Information:

Optek's Optocoupler Part Numbers		Packaging Quantities		Tube		Inner			Small Carton			Medium Carton			Large Carton		
				Qty	Weight	52 x 7 x 7.5 cm		53.5 x 16 x 17.5 cm			53.5 x 30.7 x 17.5 cm			53.5 x 30.7 x 25 cm			
						Qty	Weight	Qty	Weight	Gross Weight	Qty	Weight	Gross Weight	Qty	Weight	Gross Weight	
P/H and SMD	4-PIN OPIA400D/A, OPIA410D/A - OPIA413D/A	100	44	3,000	1.40	12,000	6.0	6.5	24,000	12.0	12.5	36,000	18.0	18.5			
	6-PIN OPIA6XXD/A Series	65	44	1,950	1.50	7,800	6.5	7.0	15,600	12.0	12.5	23,400	18.5	19.0			
	8-PIN OPIA8XXD Series and OPID804D	48	44	1,440	1.44	5,760	6.0	6.5	11,520	12.0	12.5	17,290	18.0	18.5			
M/F SOP	4-PIN and 5-PIN OPIA401B - OPIA404B, OPIA414B, OPIA500B	100	24	6,000	1.60	24,000	6.5	7.0	48,000	13.0	13.5	72,000	19.5	20.0			
SSOP	4-PIN OPIA405C - OPIA409C	170	--	10,200	--												

P/H = Pin-Hole Packages (Referred as D = Dual-In-Line Package)

SMD = Standard Surface Mount Packages (Referred as A = 6.5mil SMD)

M/F or SOP = Mini-Flat Packages or Small Outside Packages (Referred as B = 4.40mil SMD w/ 2.54mil Lead-Spacing)

SSOP = Shrink SOP Packages (Referred as C = 3.60mil SMD with 1.27mil Lead-Spacing)

OPTEK reserves the right to make changes at any time in order to improve design and to supply the best product possible.

## Tube Packaging Specifications—SMD— (TU):

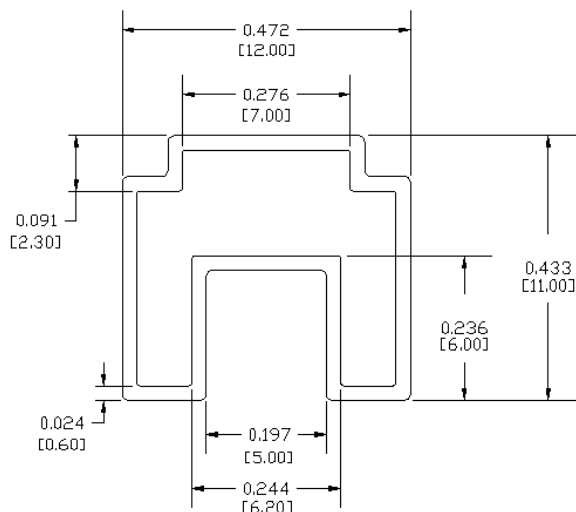

DIMENSIONS ARE IN: INCHES [MILLIMETERS]

TOLERANCE: ± 0.008 INCHES  
[± 0.2 MILLIMETERS]

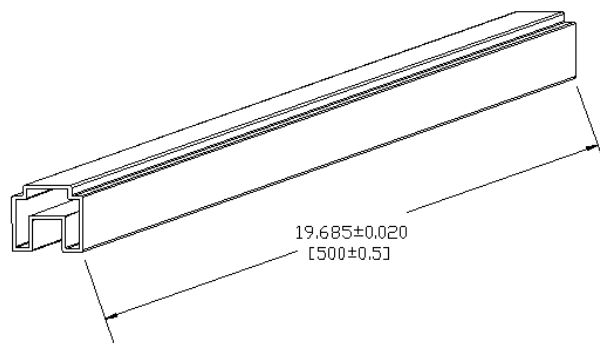

Quantity: 4-pin (SMD): 100pcs/tube

## Tube Packaging Specifications— SOP (Mini-flats) and SSOP— (TU):

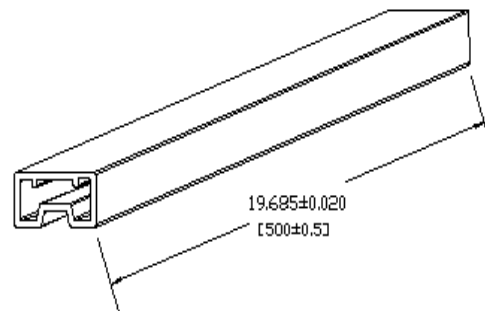
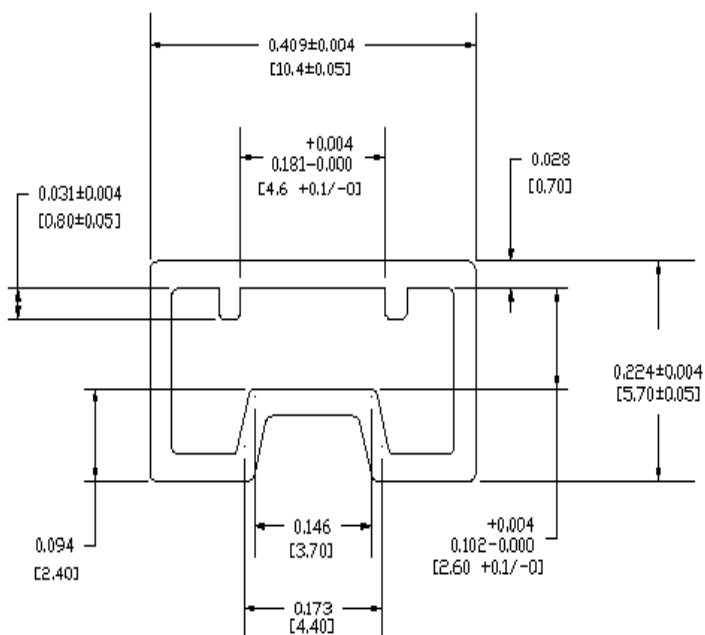

Quantity: 4-pin (SOP): 100pcs/tube  
4-pin (SSOP): 170pcs/tube

OPTEK reserves the right to make changes at any time in order to improve design and to supply the best product possible.

# Optocoupler—SMD, SOP and SSOP Packages OPIA400 through OPIA414



## Tape and Reel Packaging Specifications— SMD and SOP—(TR):

### Tape Feeder:

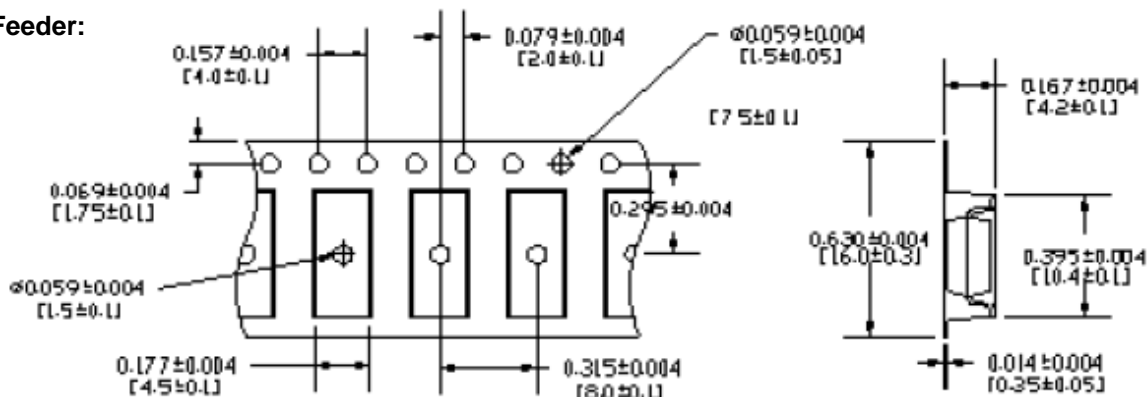

### Direction:

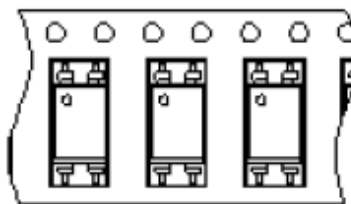

**Quantity:** 4-pin (SMD): 1000pcs/Reel  
 4-pin (SOP): 1000pcs/Reel  
 4-pin (SSOP): 3000pcs/Reel

DIMENSIONS ARE IN: INCHES [MILLIMETERS]

TOLERANCE: ± 0.008 INCHES  
 [± 0.2 MILLIMETERS]

### Reel:

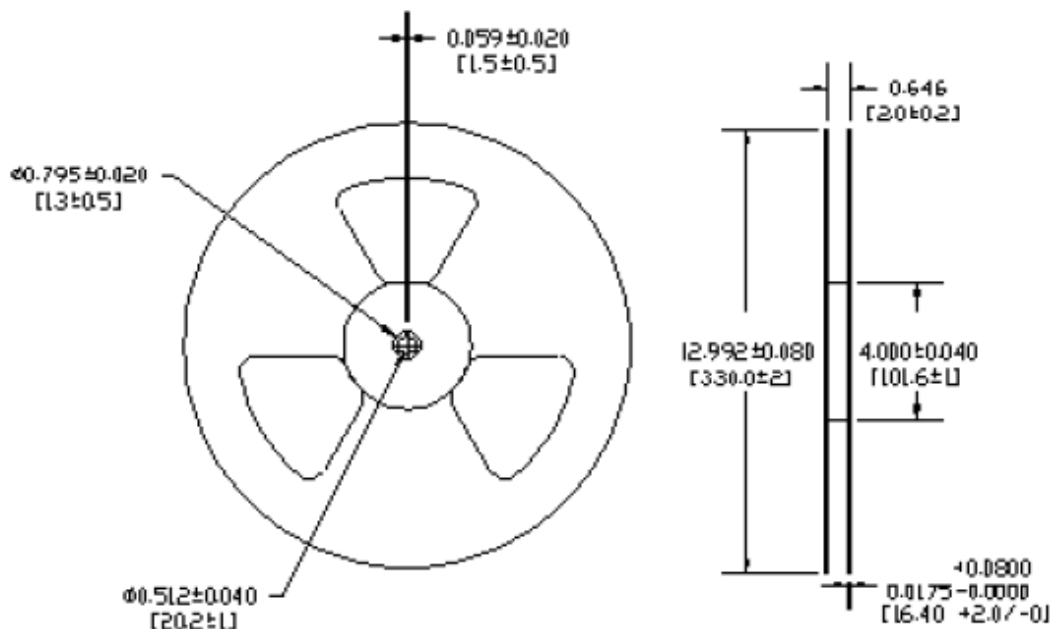

OPTEK reserves the right to make changes at any time in order to improve design and to supply the best product possible.



# Optocoupler—SMD, SOP and SSOP Packages OPIA400 through OPIA414



## Tape and Reel Packaging Specifications— SSOP—(TR):

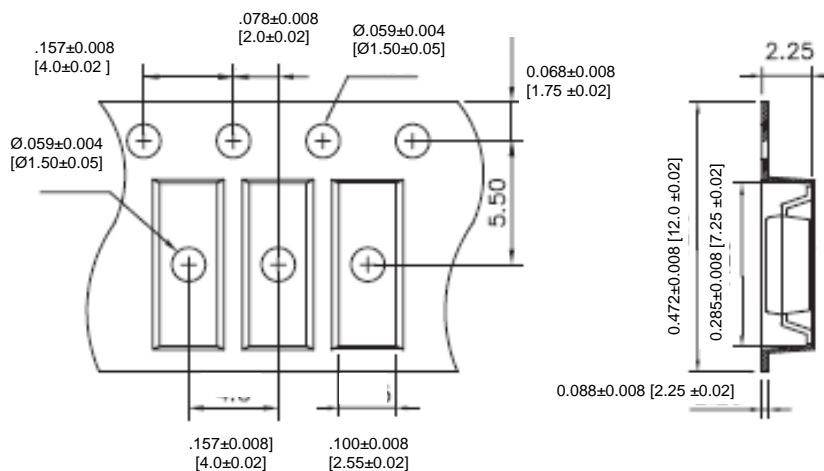

**Direction:**

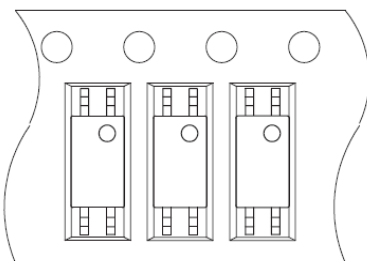

**DIMENSIONS ARE IN: INCHES [MILLIMETERS]**

**TOLERANCE:  $\pm 0.008$  INCHES  
[ $\pm 0.2$  MILLIMETERS]**

**Reel:**

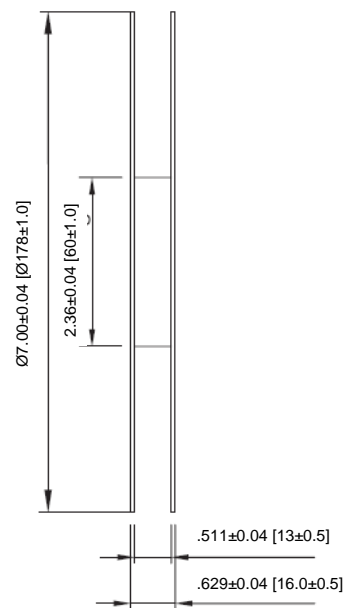
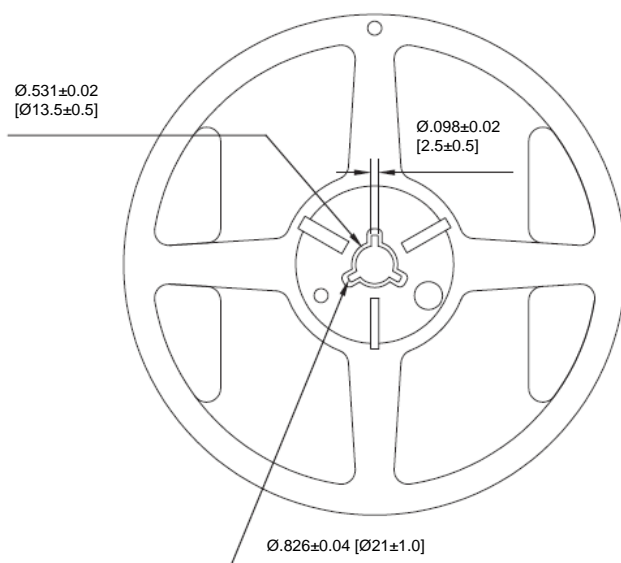

**Quantity: 4-pin (SSOP): 2000pcs/Reel**

OPTEK reserves the right to make changes at any time in order to improve design and to supply the best product possible.

# Mouser Electronics

Authorized Distributor

Click to View Pricing, Inventory, Delivery & Lifecycle Information:

## TT electronics:

[OPIA410ATR](#) [OPIA414BTR](#) [OPIA405CTRE](#) [OPIA403BTUE](#) [OPIA401BTUE](#) [OPIA407CTUE](#) [OPIA404BTUE](#)

## TT Electronics:

[OPIA411ATU](#) [OPIA413ATR](#) [OPIA405CTUE](#) [OPIA408CTUE](#) [OPIA412ATU](#) [OPIA410ATU](#) [OPIA406CTU](#)  
[OPIA402BTU](#) [OPIA404BTR](#) [OPIA403BTRE](#) [OPIA403BTU](#) [OPIA408CTU](#) [OPIA402BTRB](#) [OPIA404BTRE](#)  
[OPIA400ATR](#) [OPIA406CTUE](#) [OPIA404BTU](#) [OPIA403BTR](#) [OPIA401BTU](#) [OPIA412ATR](#) [OPIA401BTR](#) [OPIA402BTR](#)  
[OPIA409CTUE](#) [OPIA405CTU](#) [OPIA409CTU](#) [OPIA411ATR](#) [OPIA402BTUB](#) [OPIA414BTU](#) [OPIA400ATU](#)  
[OPIA407CTU](#) [OPIA413ATU](#) [OPIA401BTRE](#)