

Fiber Optic Transmitter

OPF347 Family



OPF347 Family

- Low Cost 850 nm LED technology
- Popular ST[®] style receptacle
- Pre-tested with fiber to assure performance
- Component pre-mounted and ready to use
- Extended temperature range
- 75MHz operation

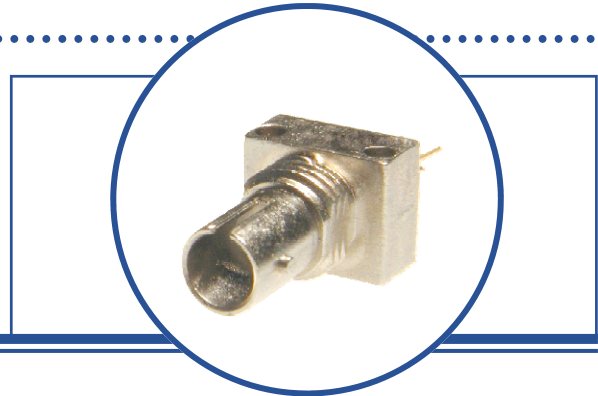

The OPF347 family fiber optic transmitters are high performance devices packaged for data communication links. This transmitter is an 850nm GaAlAs LED and is specifically designed to efficiently launch optical power into fibers ranging in size from 50/125 μ m up to 200/300 μ m diameter fiber. Multiple power ranges with upper and lower limits are offered which allows the designer to select a device best suited for the application.

This product's combination of features including high speed and efficient coupled power makes it an ideal transmitter for integration into all types of data communications equipment.

The mechanical design of this packaged is intended for PC Board or panel mounting. It is shipped with a lock washer, jam nut, 2 #2-56 screws, and a protective dust cap.

Applications

- ◆ Industrial Ethernet equipment
- ◆ Copper-to-fiber media conversion
- ◆ Intra-system fiber optic links
- ◆ Video surveillance systems

Typical Coupled Power $I_F = 100\text{mA}, 25^\circ\text{C}$						
Fiber Size	Type	N.A.	OPF347A	OPF347B	OPF347C	OPF347D
50/125 μ m	Graded Index	0.20	25 μ W	18 μ W	12.5 μ W	7.5 μ W
62.5/125 μ m	Graded Index	0.28	45 μ W	34 μ W	22 μ W	14 μ W
100/140 μ m	Graded Index	0.29	125 μ W	95 μ W	62 μ W	38 μ W
200/300 μ m	Step Index	0.41	475 μ W	340 μ W	235 μ W	140 μ W



RoHS



ESD Class 2

All Optek OPF LED emitters are AEL Class I as defined by IEC 60825-1 and are Risk Group 1 (Low-Risk) as defined by IEC 62471.

ST[®] is a registered trademark of AT&T.

OPTEK reserves the right to make changes at any time in order to improve design and to supply the best product possible.

Absolute Maximum Ratings

$T_A = 25^\circ\text{C}$ unless otherwise noted

Storage Temperature Range	-55° C to +150° C
Operating Temperature Range	-40° C to +125° C
Lead Soldering Temperature ⁽¹⁾	260° C
Continuous Forward Current ⁽²⁾	100 mA
Maximum Reverse Voltage	1.0 V

Electrical/Optical Characteristics ($T_A = 25^\circ\text{C}$ unless otherwise noted)

SYMBOL	PARAMETER	MIN	TYP	MAX	UNITS	CONDITIONS
P_{OC}	Total Coupled Power 50/125 mm Fiber, NA = 0.20	OPF347A	20.0	25.0		μW $I_F = 100\text{ mA}$
		OPF347B	15.0	18.0		
		OPF347C	10.0	12.5		
		OPF347D	5.0	7.5		
V_F	Forward Voltage		1.8	2.2	V	$I_F = 100\text{ mA}$
V_R	Reverse Voltage	1.8			V	$I_R = 100\ \mu\text{A}$
λ	Wavelength	830	850	870	nm	$I_F = 50\text{ mA}$
$\Delta\lambda$	Optical Bandwidth		45	60	nm	$I_F = 50\text{ mA}$
t_r, t_f	Rise and Fall Time		3.5	4.5	ns	$I_F = 100\text{ mA}; 10\% \text{ to } 90\%^{(3)}$

Notes:

- Maximum of 5 seconds with soldering iron. Duration can be extended to 10 seconds when flow soldering. RMA flux is recommended.
- De-rate linearly at 0.64 mA /°C above 25°C .
- No Pre-bias.
- All Optek fiber optic LED products are subjected to 100% burn-in as part of its quality control process. The burn-in conditions are 96 hours at 100mA drive current and 25°C ambient temperature.

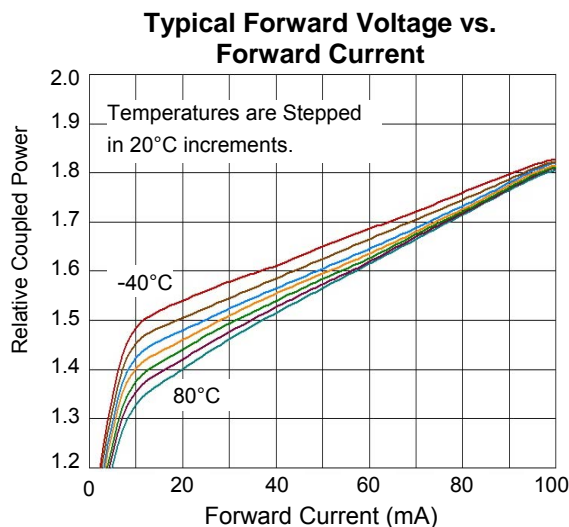
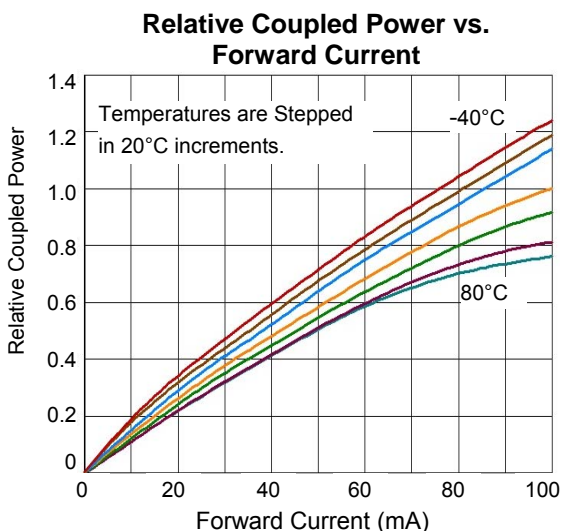

OPTEK reserves the right to make changes at any time in order to improve design and to supply the best product possible.

Mechanical Data

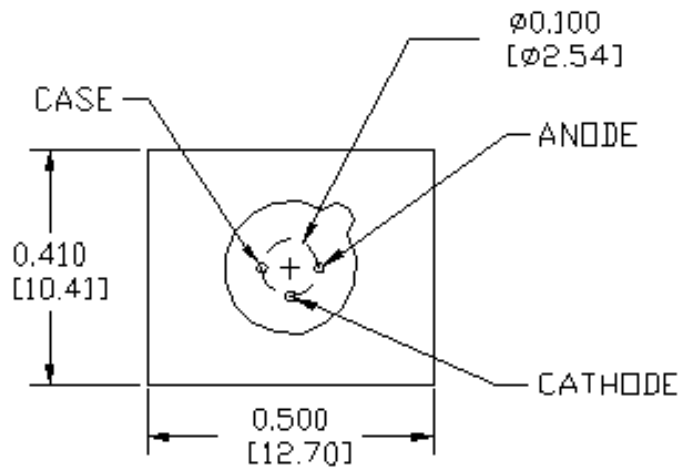
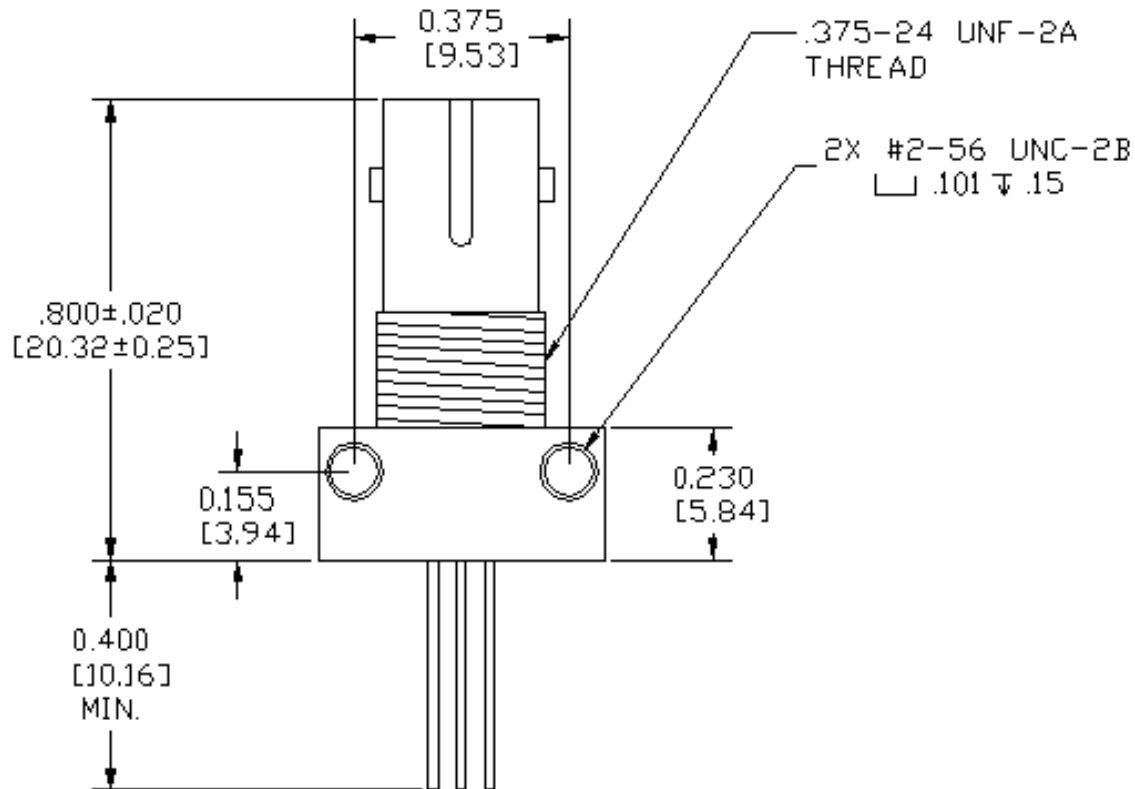

DIMENSIONS ARE IN INCHES (MILLIMETERS)

OPTEK reserves the right to make changes at any time in order to improve design and to supply the best product possible.

Mouser Electronics

Authorized Distributor

Click to View Pricing, Inventory, Delivery & Lifecycle Information:

[TT Electronics:](#)

[OPF347B](#) [OPF347C](#) [OPF347D](#)