

9 – 10.5 GHz High Power Amplifier

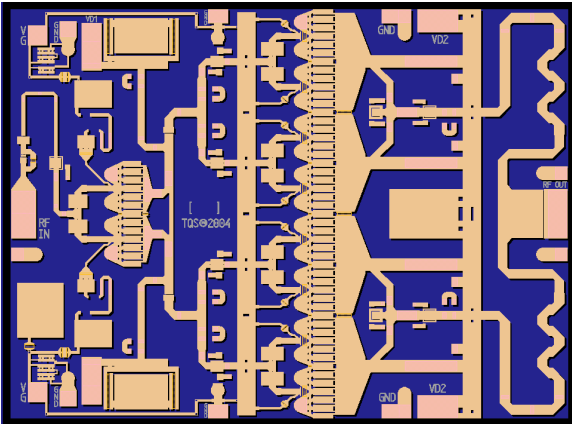

Key Features

- Frequency Range: 9.0 -10.5 GHz
- 38 dBm Nominal Output Power
- 20 dB Nominal Gain
- Bias: 7-9V, 1.4A & 1.05A (~ 2A under RF drive)
- 0.25 um 3MI pHEMT Technology
- Chip Dimensions 3.52 x 2.61 x 0.10 mm (0.139 x 0.103 x 0.004 in)

Primary Applications

- Point-to-Point Radio Communications

Product Description

The TriQuint TGA2704 is a High Power Amplifier MMIC for 9 – 10.5GHz applications. The part is designed using TriQuint’s 0.25um 3MI pHEMT production process.

The TGA2704 nominally provides 38 dBm output power and 40% PAE for bias of 9V, 1.05A. The typical gain is 20 dB.

The part is ideally suited for low cost markets such as Point-to-Point Radio and Communications.

The TGA2704 is 100% DC and RF tested on-wafer to ensure performance compliance.

The TGA2704 has a protective surface passivation layer providing environmental robustness.

Lead-Free & RoHS compliant.

Measured Fixtured Data

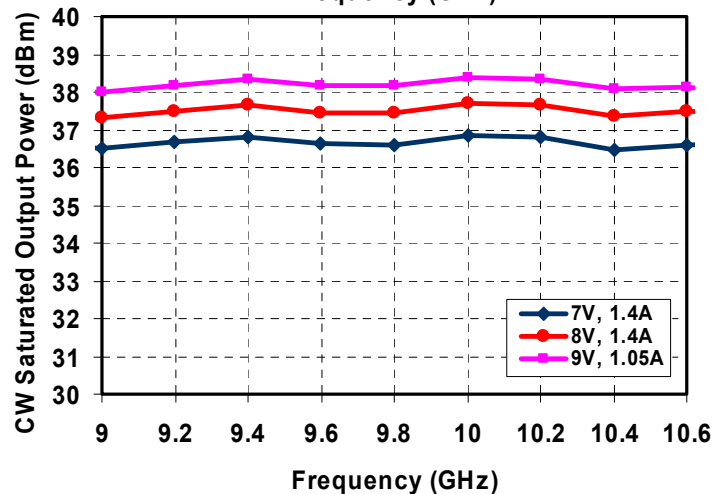
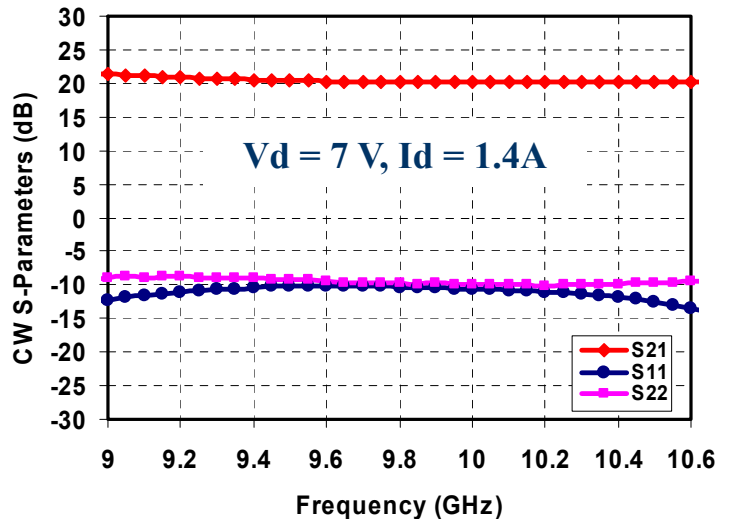

Datasheet subject to change without notice

TABLE I
MAXIMUM RATINGS 1/

SYMBOL	PARAMETER	VALUE	NOTES
V _d	Drain Voltage	10 V	<u>2/</u>
V _g	Gate Voltage Range	-1 TO +0.5 V	
I _d	Drain Current	3.85 A	<u>2/</u> <u>3/</u>
I _g	Gate Current	85 mA	<u>3/</u>
P _{IN}	Input Continuous Wave Power	23 dBm	
P _D	Power Dissipation	18.3 W	<u>2/</u> <u>4/</u>
T _{CH}	Operating Channel Temperature	200 °C	<u>5/</u>
	Mounting Temperature (30 Seconds)	320 °C	
T _{STG}	Storage Temperature	-65 to 150 °C	

- 1/ These ratings represent the maximum operable values for this device.
- 2/ Combinations of supply voltage, supply current, input power, and output power shall not exceed P_D.
- 3/ Total current for the entire MMIC.
- 4/ When operated at this power dissipation with a base plate temperature of 70 °C, the median life is 2.3E4 hrs.
- 5/ Junction operating temperature will directly affect the device median time to failure (T_m). For maximum life, it is recommended that junction temperatures be maintained at the lowest possible levels.

TABLE II
ELECTRICAL CHARACTERISTICS
 (Ta = 25 °C Nominal)

PARAMETER	TYPICAL	TYPICAL	UNITS
Frequency Range	9.0 – 10.5	9.0 – 10.5	GHz
Drain Voltage, Vd	7	9	V
Drain Current, Id	1.4	1.05	A
Gate Voltage, Vg	-0.6	-0.6	V
Small Signal Gain, S21	20	19	dB
Input Return Loss, S11	10	10	dB
Output Return Loss, S22	10	10	dB
CW Saturated Output Power @ 19 dBm Pin	36.5	38	dBm
Pulsed Saturated Output Power @ 19 dBm Pin & 25% Duty Cycle	36.7	38.5	dBm
CW Power Added Eff. @ 19 dBm Pin	40	39	%
Pulsed Power Added Eff. @ 19 dBm Pin & 25% Duty Cycle	39	38	%
Small Signal Gain Temperature Coefficient	-0.03	-0.03	dB/°C

**TABLE III
THERMAL INFORMATION**

PARAMETER	TEST CONDITIONS	T _{CH} (°C)	θ _{JC} (°C/W)	T _m (HRS)
θ _{JC} Thermal Resistance (channel to Case)	V _d = 7 V I _d = 1.4 A P _{diss} = 9.8W Small Signal	140	7.1	2.4E+6
θ _{JC} Thermal Resistance (channel to Case)	V _d = 7 V I _d = 1.7 A @ P _{sat} P _{diss} = 7.2 W P _{out} = 4.8 W (RF)	121	7.1	1.4E+7

Note: Assumes eutectic attach using 1.5 mil 80/20 AuSn mounted to a 20 mil CuMo Carrier at 70°C baseplate temperature.

Median Lifetime (T_m) vs. Channel Temperature

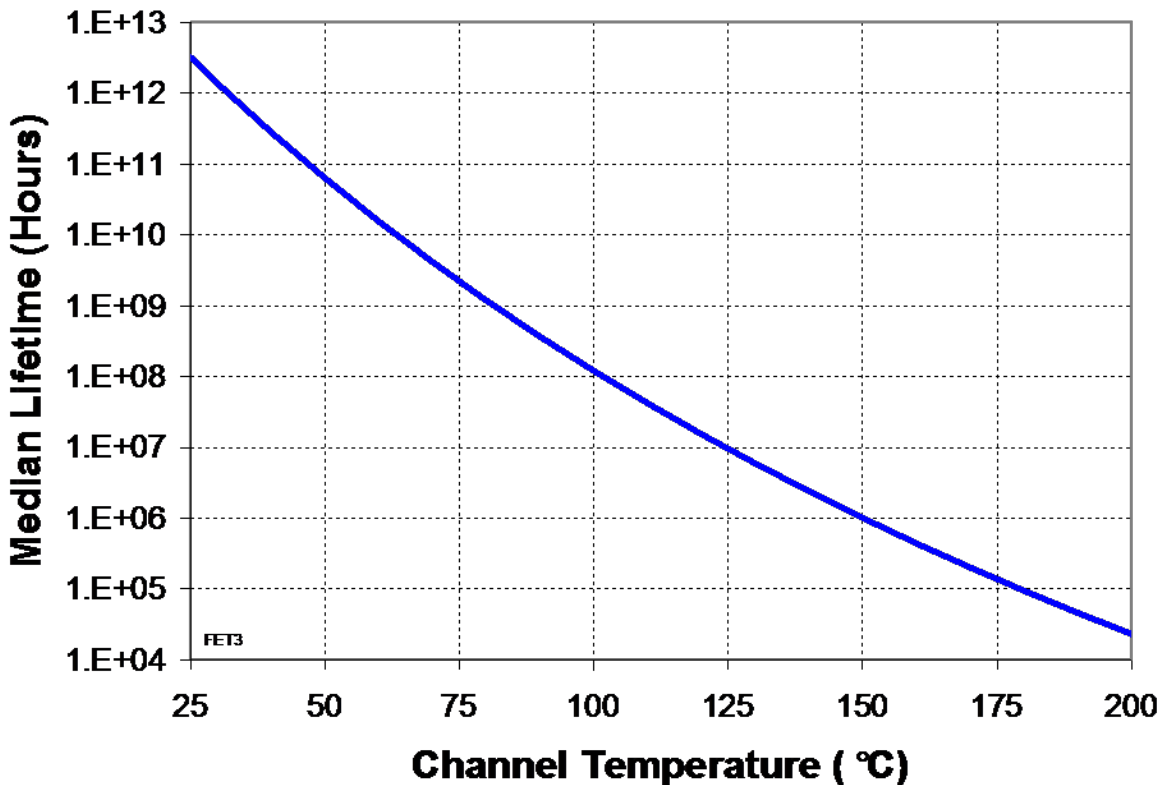

Measured Data

Bias Conditions: $V_d = 7V$, $I_{dq} = 1.4 A$

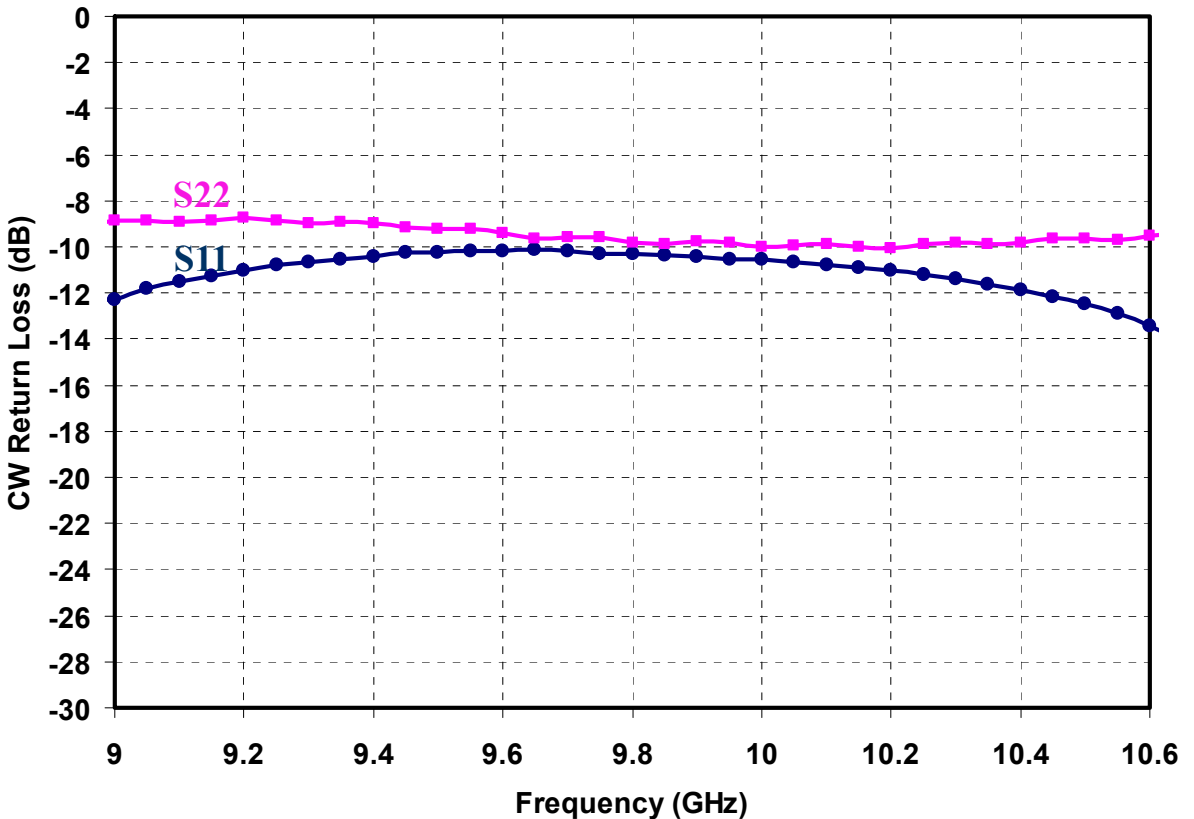
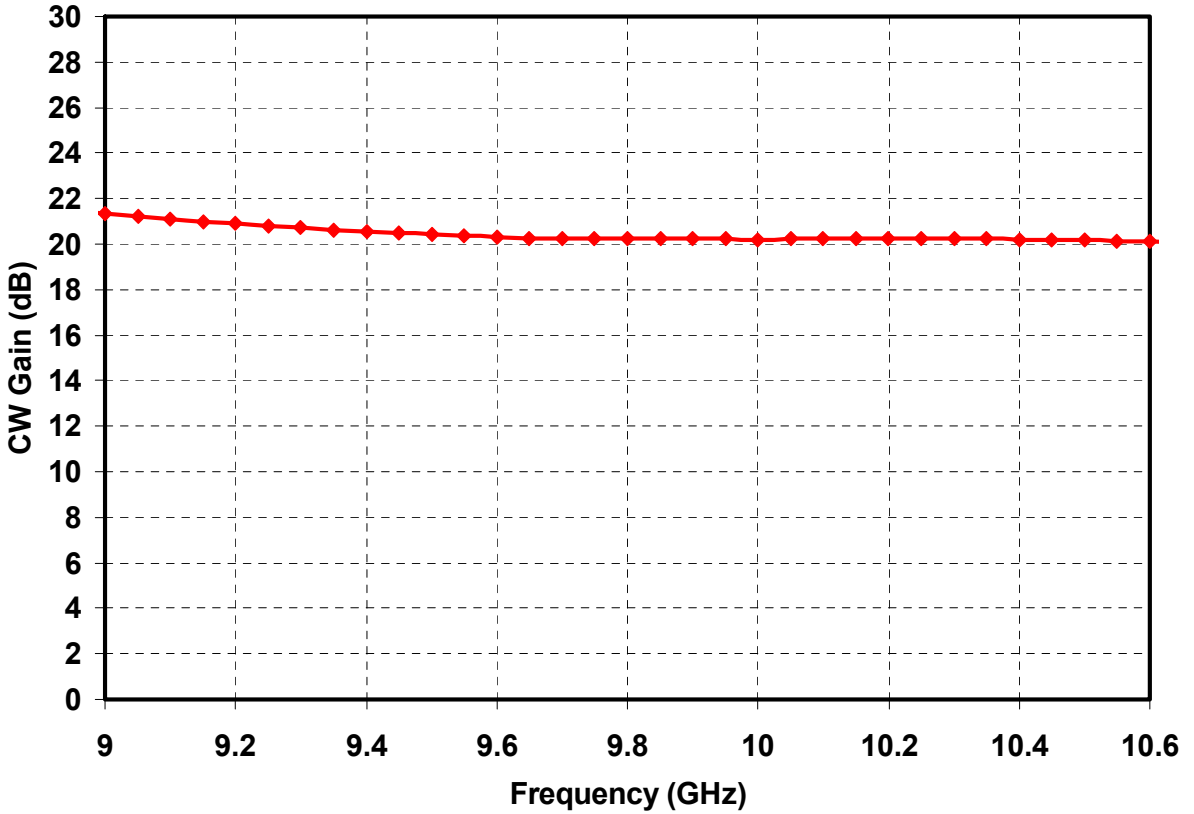

Measured Data

Pin = 19dBm, CW Power

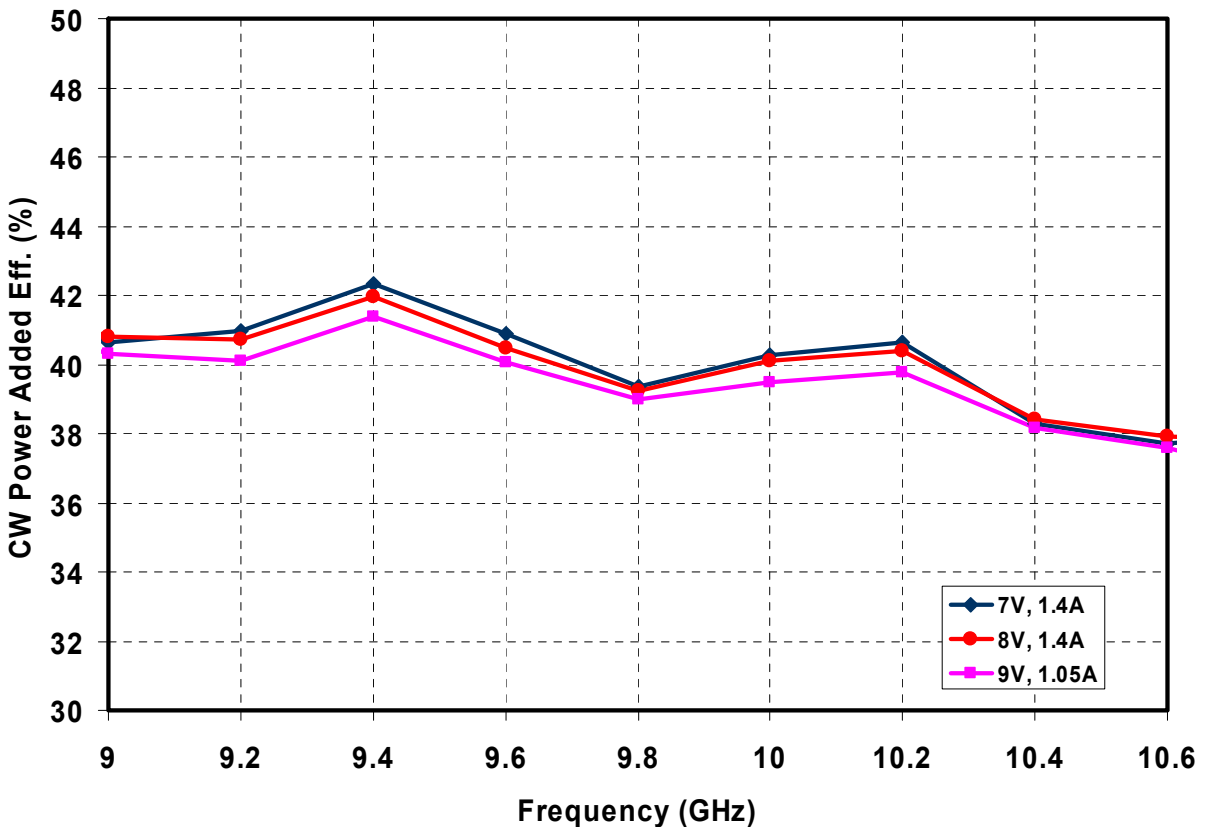
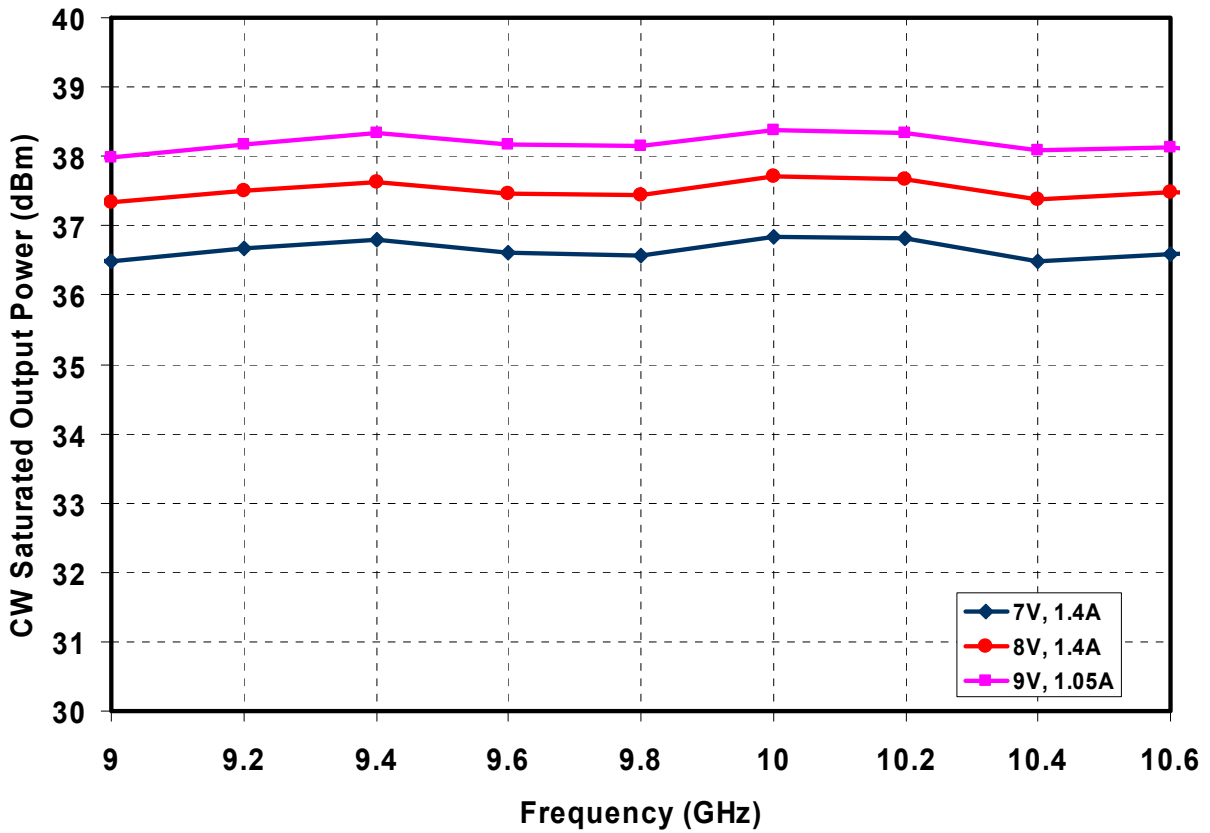

Measured Data
Frequency @ 10GHz, CW Power

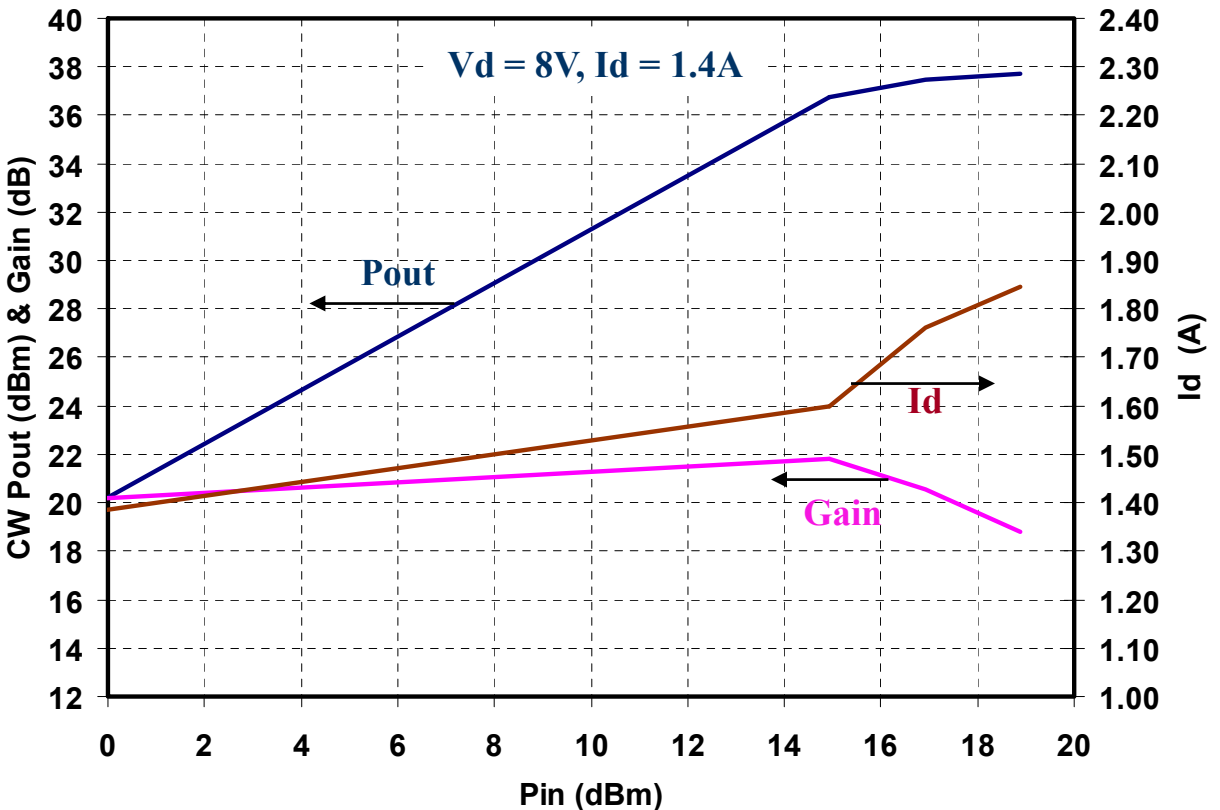
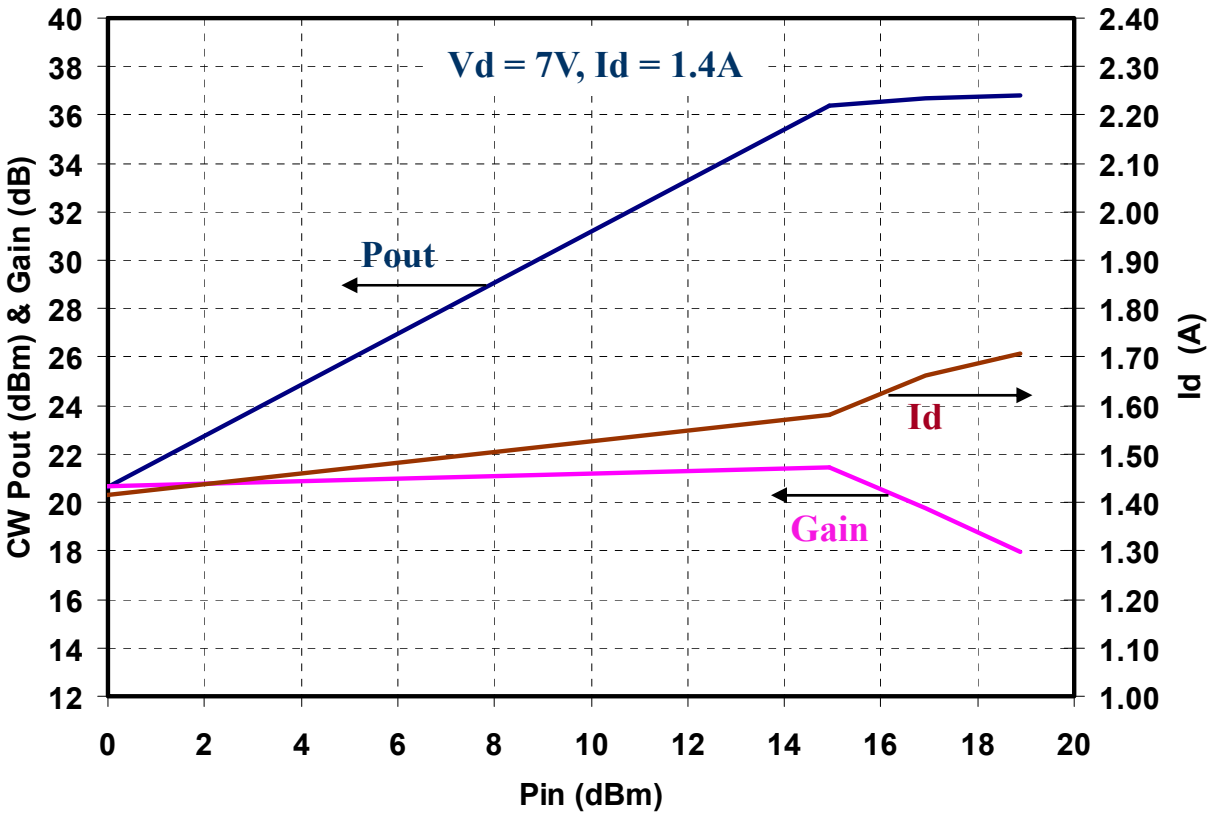

Measured Data
Frequency @ 10GHz, CW Power

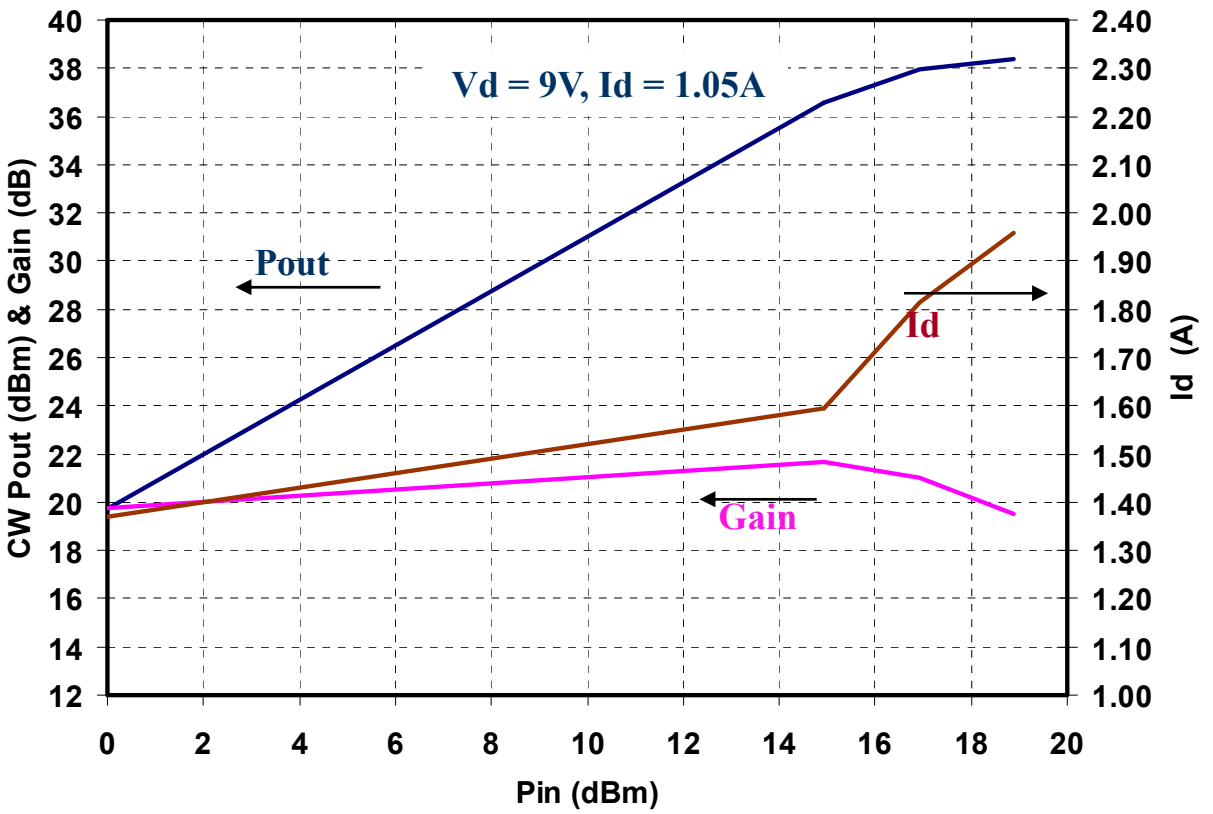

Measured Data

Pin = 19dBm, Pulsed Power, 25% DC

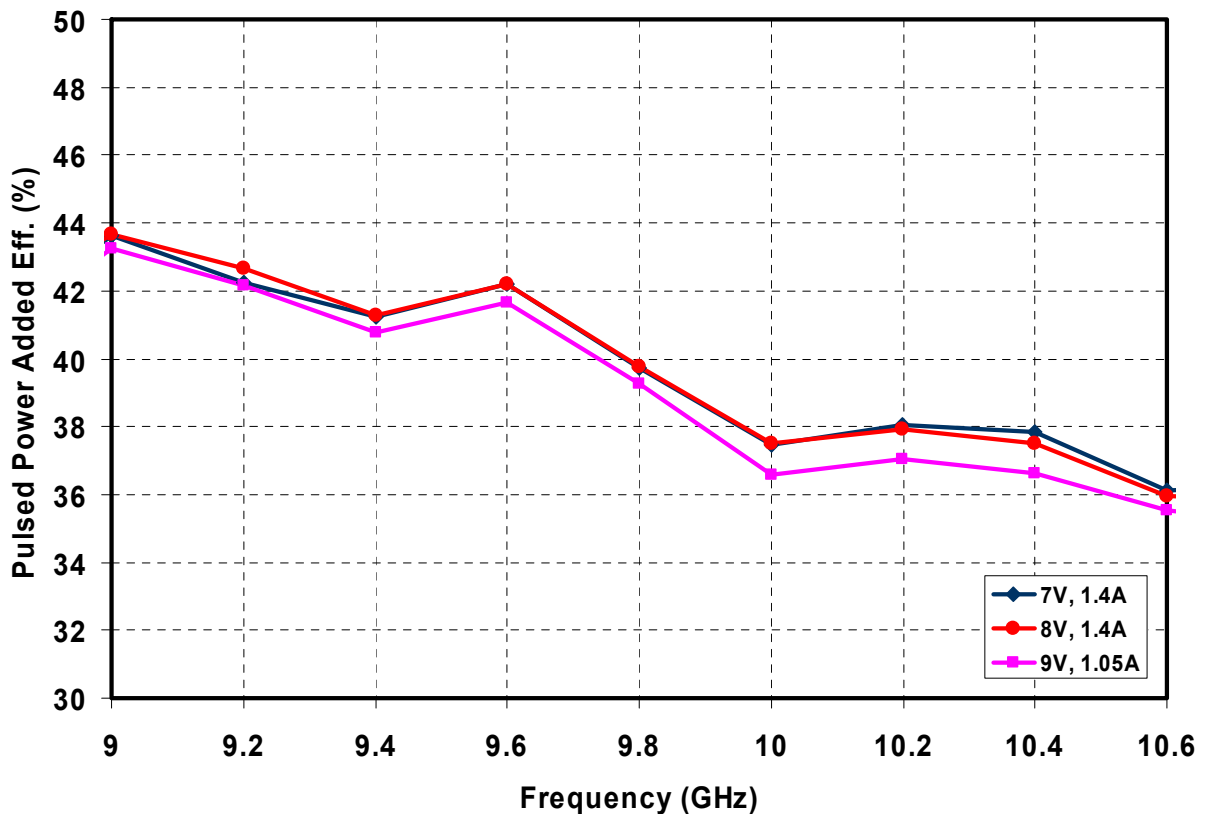
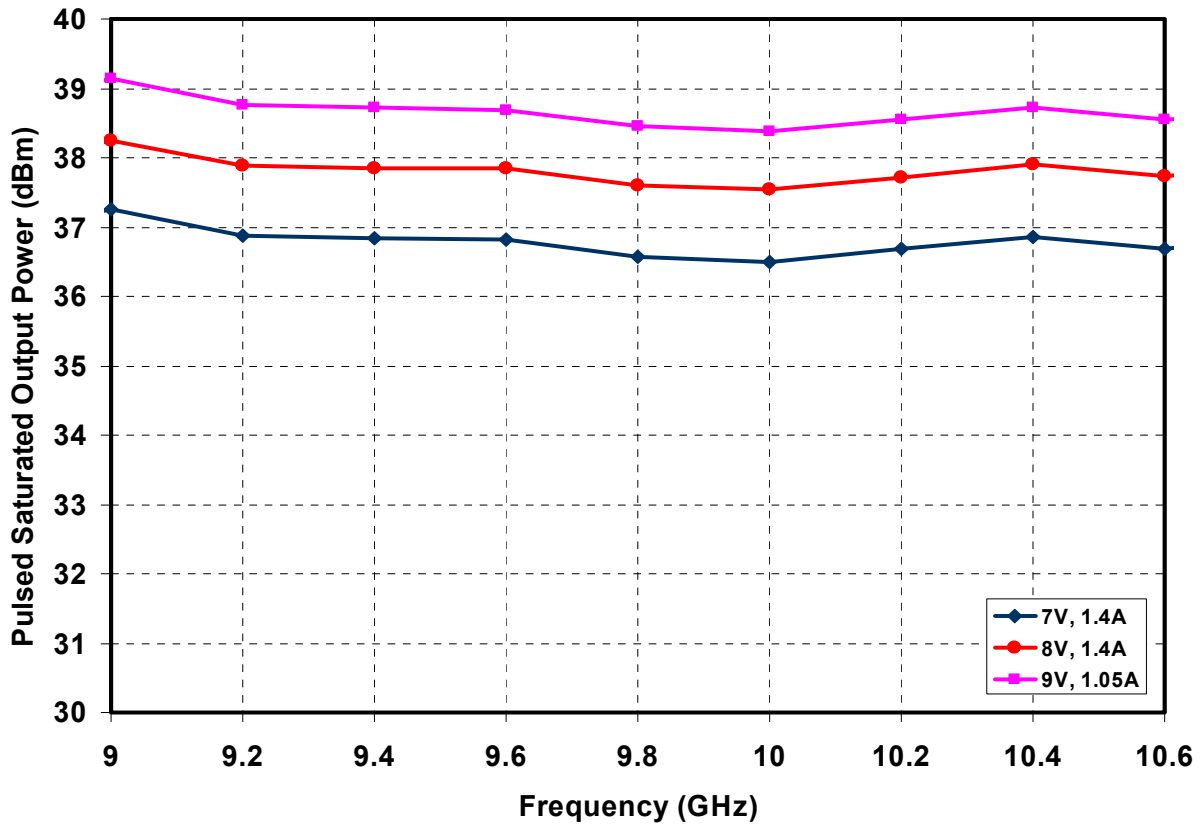

Measured Data

Frequency @ 10GHz, Pulsed Power, 25% DC

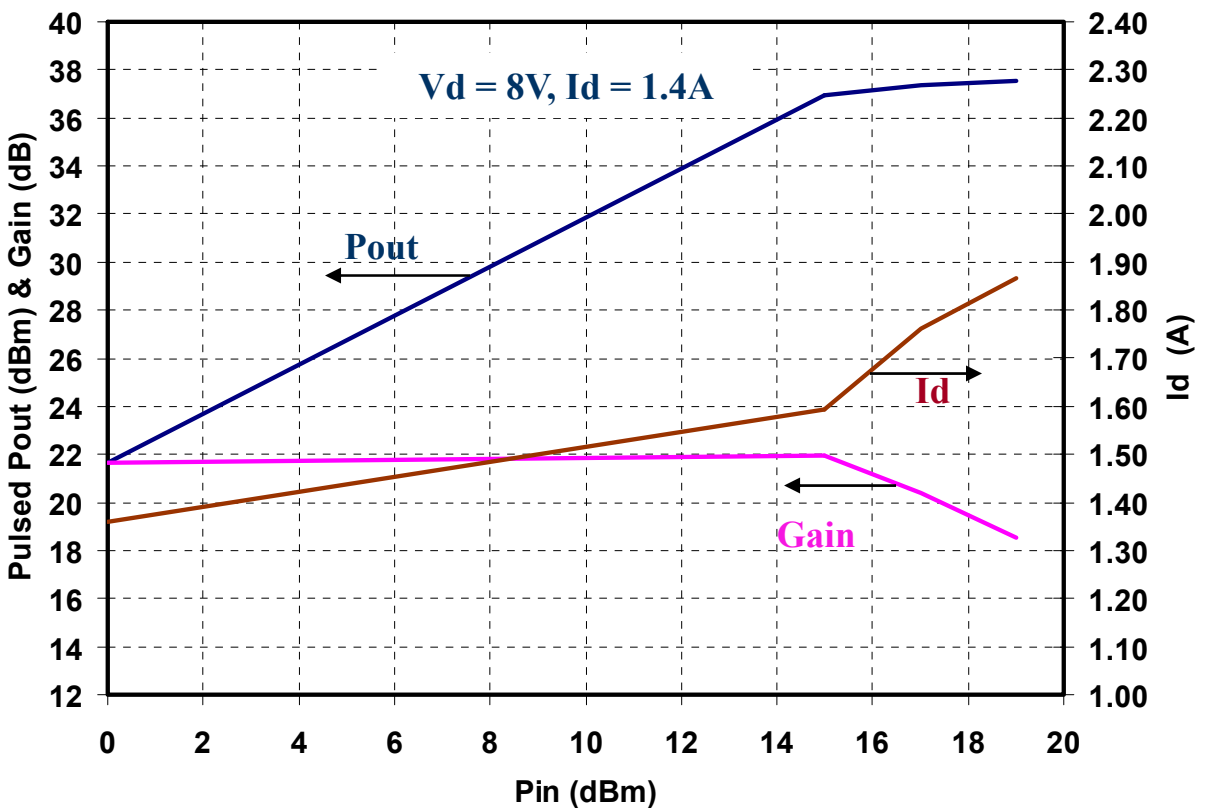
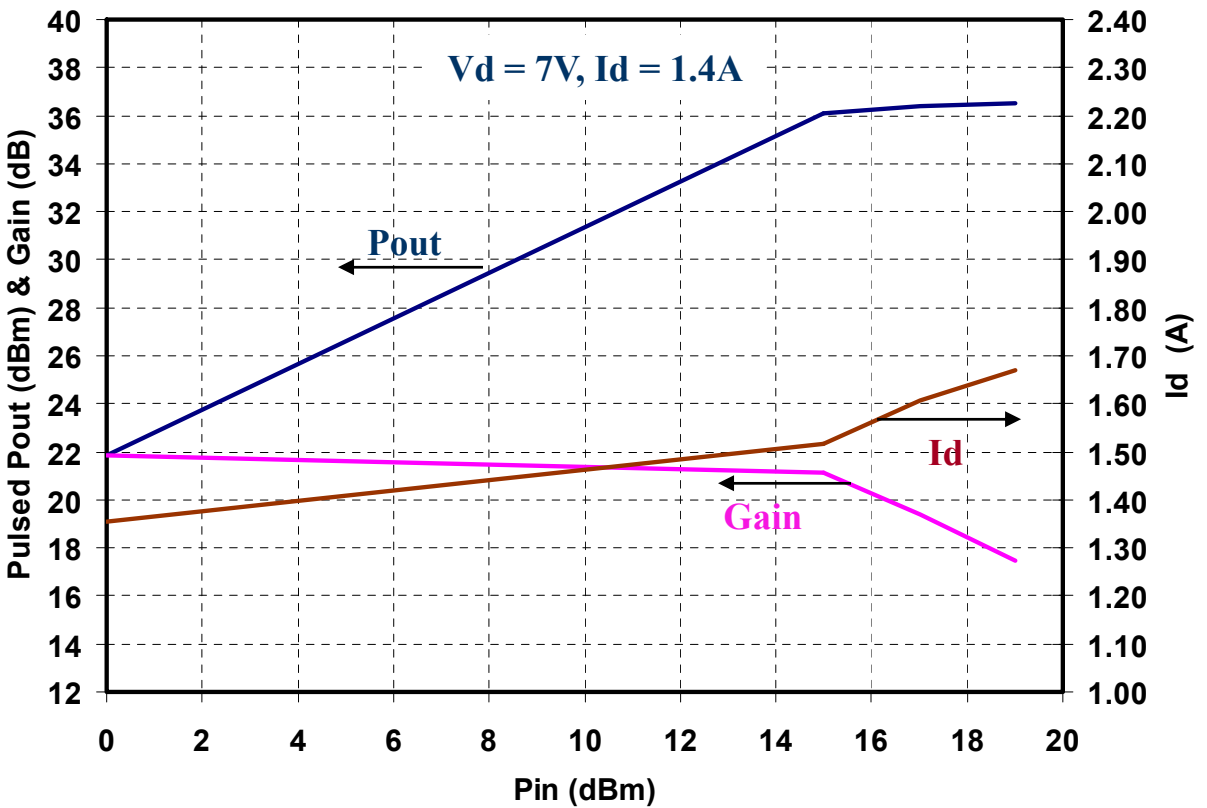

Measured Data

Frequency @ 10GHz, Pulsed Power, 25% DC

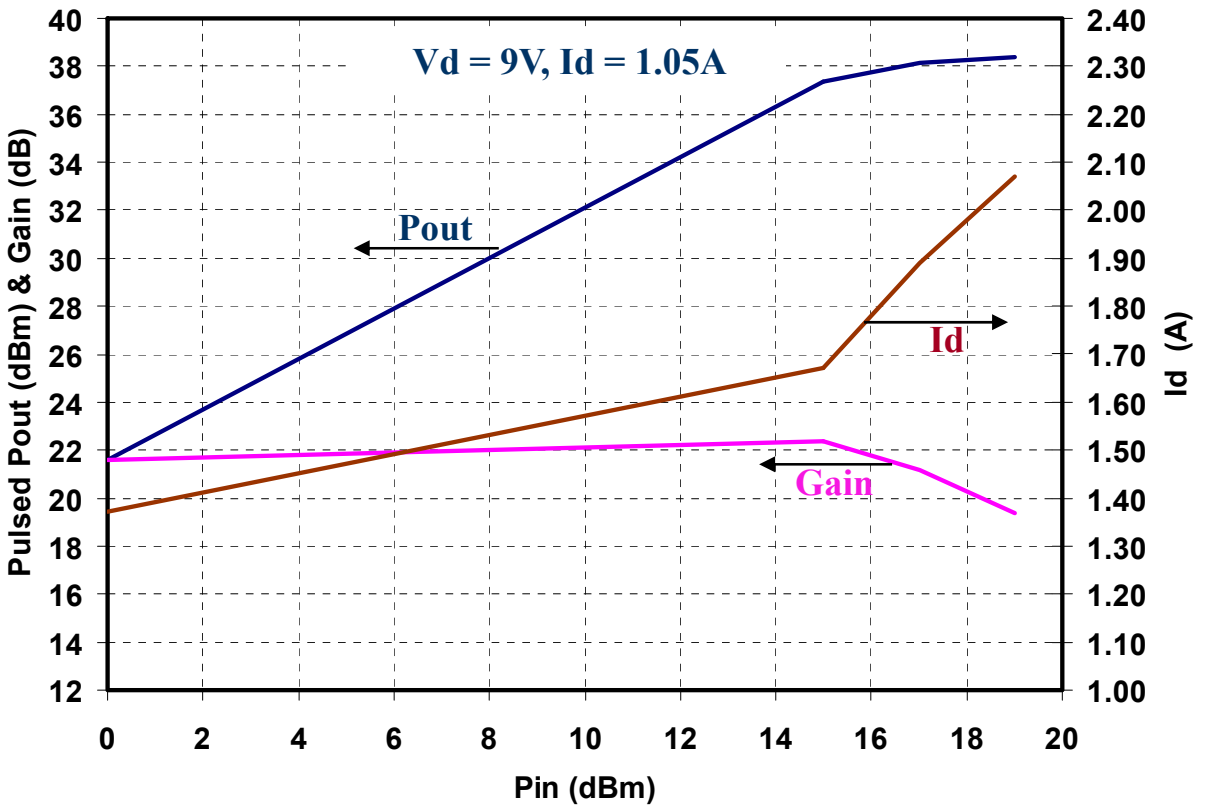

Measured Data

Frequency @ 10GHz, CW TOI

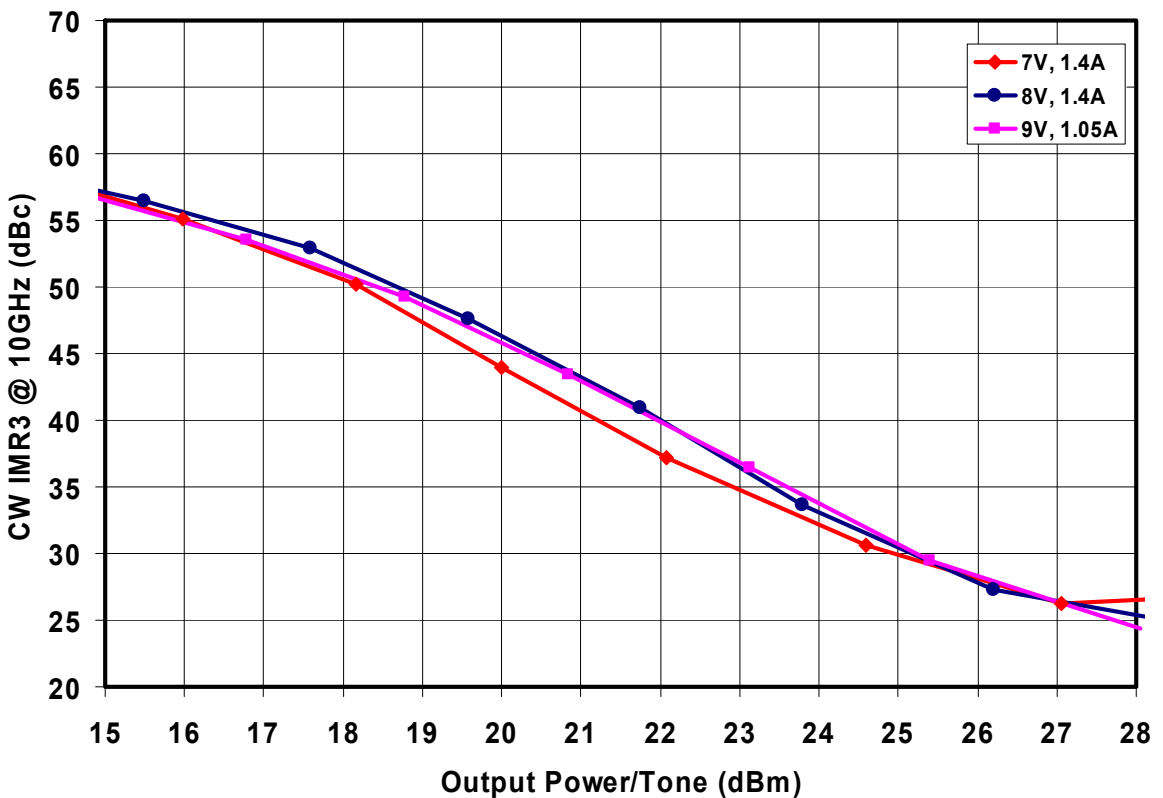
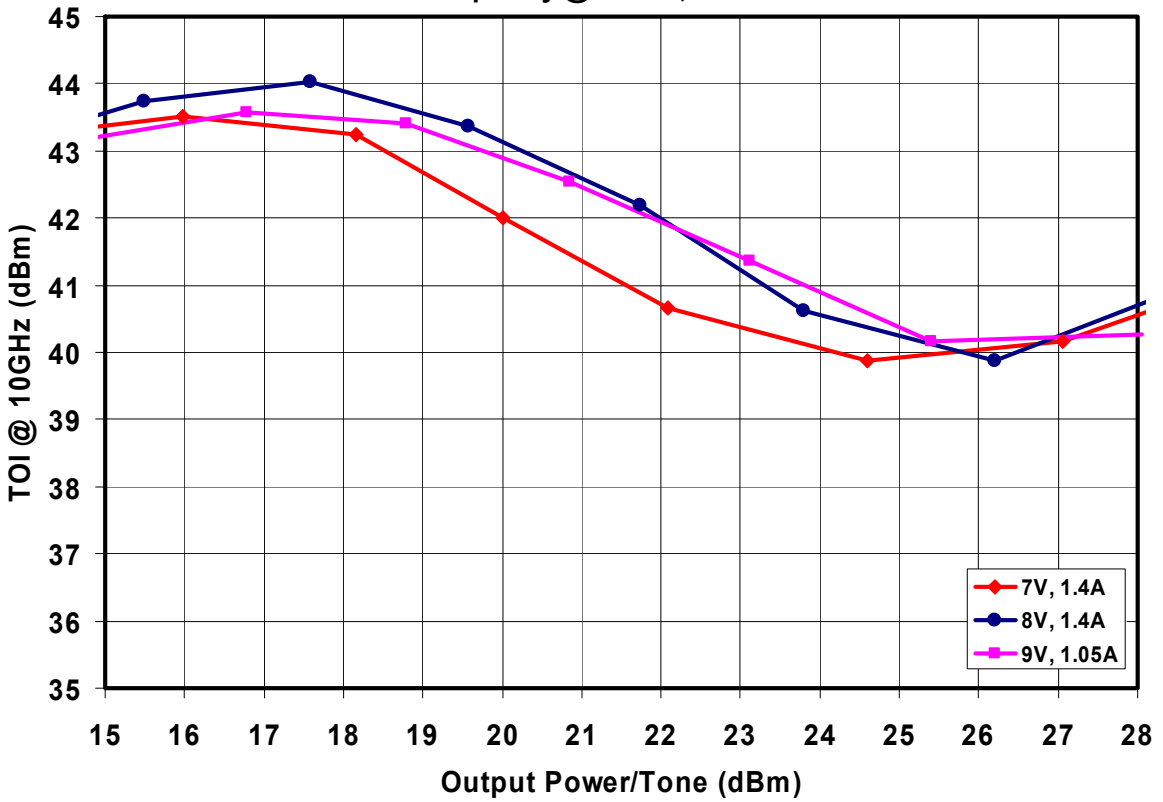

Mechanical Drawing

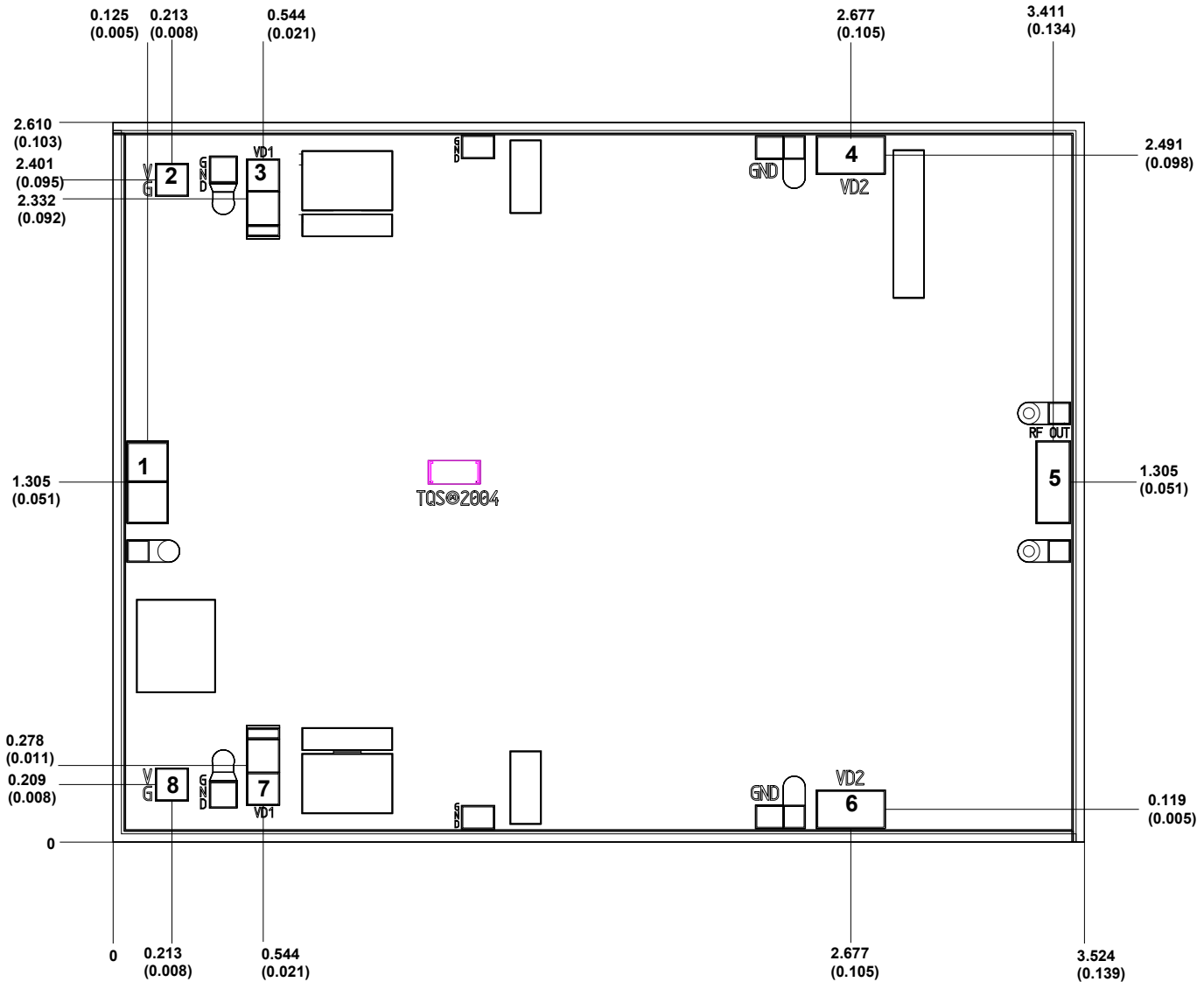

Units: Millimeters (inches)

Thickness: 0.10 (0.004)

Chip edge to bond pad dimensions are shown to center of bond pad

Chip size tolerance: +/- 0.05 (0.002)

GND IS BACKSIDE OF MMIC

Bond pad # 1	(RF Input)	0.150 x 0.300 (0.006 x 0.012)
Bond pad # 2, 8	(Vg)	0.120 x 0.120 (0.005 x 0.005)
Bond pad # 3, 7	(Vd1)	0.120 x 0.290 (0.005 x 0.011)
Bond pad # 4, 6	(Vd2)	0.250 x 0.140 (0.010 x 0.006)
Bond pad # 5	(RF Output)	0.125 x 0.300 (0.005 x 0.012)

GaAs MMIC devices are susceptible to damage from Electrostatic Discharge. Proper precautions should be observed during handling, assembly and test.

Recommended Chip Assembly Diagram

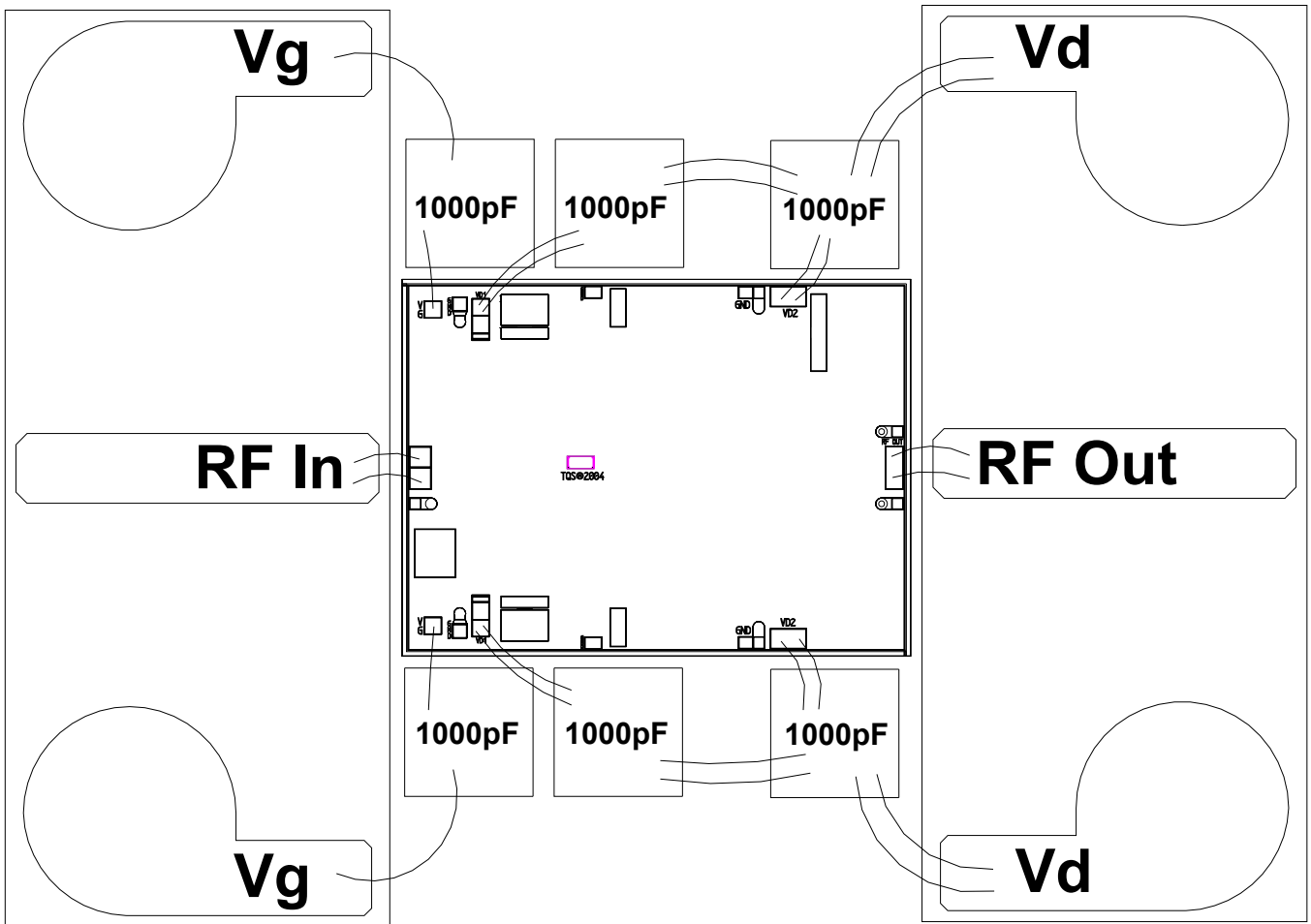

Vd = 7 to 9 V

Vg = -0.6 V Typical

GaAs MMIC devices are susceptible to damage from Electrostatic Discharge. Proper precautions should be observed during handling, assembly and test.

Assembly Process Notes

Reflow process assembly notes:

- Use AuSn (80/20) solder with limited exposure to temperatures at or above 300⁰C (30 seconds max).
- An alloy station or conveyor furnace with reducing atmosphere should be used.
- No fluxes should be utilized.
- Coefficient of thermal expansion matching is critical for long-term reliability.
- Devices must be stored in a dry nitrogen atmosphere.

Component placement and adhesive attachment assembly notes:

- Vacuum pencils and/or vacuum collets are the preferred method of pick up.
- Air bridges must be avoided during placement.
- The force impact is critical during auto placement.
- Organic attachment can be used in low-power applications.
- Curing should be done in a convection oven; proper exhaust is a safety concern.
- Microwave or radiant curing should not be used because of differential heating.
- Coefficient of thermal expansion matching is critical.

Interconnect process assembly notes:

- Thermosonic ball bonding is the preferred interconnect technique.
- Force, time, and ultrasonics are critical parameters.
- Aluminum wire should not be used.
- Maximum stage temperature is 200⁰C.

GaAs MMIC devices are susceptible to damage from Electrostatic Discharge. Proper precautions should be observed during handling, assembly and test.

Mouser Electronics

Authorized Distributor

Click to View Pricing, Inventory, Delivery & Lifecycle Information:

[Qorvo:](#)

[TGA2704](#)