

QM28017

GNSS, MHB and UHB/5G WiFi Antennaplexer

Product Overview

The QM28017 is part of Qorvo’s family of antennaplexers using patented technology to meet the high performance expectations of insertion loss and rejection for GNSS, MHB Cellular and UHB/5GHz WiFi systems under all operating conditions

The QM28017 is a compact filter module designed to meet the strict requirements of out of band attenuation while optimizing for insertion loss of GNSS, MHB Cellular, and UHB/5GHz WiFi from 1559.05 MHz – 1605.89 MHz, 1427.9 MHz – 2690 MHz, and 3300 MHz – 5925 MHz respectively.

The QM28017 uses common module packaging techniques to achieve a compact 2.0 mm x 1.6 mm footprint.



9 Pin 2.0mm x 1.6mm x 0.6mm leadless SMT package

Functional Block Diagram

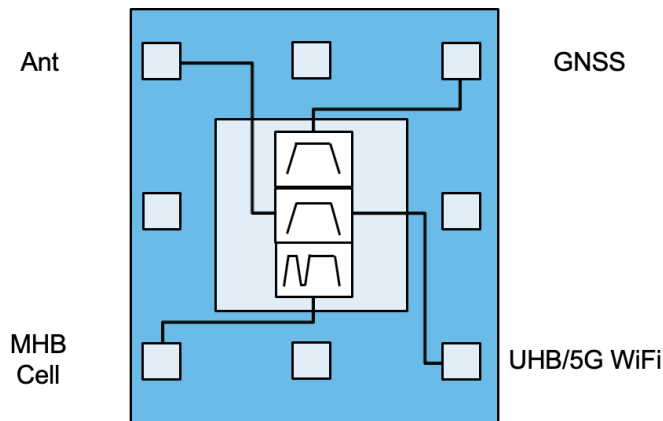

Top View

Key Features

- Compact Form-Factor: 2.0 mm x 1.6 mm
- Highly selective filters achieving low insertion loss and high attenuation over full bandwidth
- Single antenna port, antennaplexing
- RoHS Compliant, Pb-Free Module Package

Applications

- For devices with GNSS, MHB (including NR), and UHB/5GHz WiFi (including NR and LAA)

Ordering Information

Part Number	Description
QM28017EVB	Evaluation Board (EVB)
QM28017SB	Sample bag of 5 pieces
QM28017SR	Sample reel of 100 pieces
QM28017TR13	13 inch reel of 10k pieces

Absolute Maximum Ratings

Parameter	Conditions	Rating	UNITS	
Storage Temperature		-40 to +90	°C	
Operating Case Temperature		-30 to +85	°C	
RF Input Power (Pin3, MHB Cellular)	1427.9 MHz – 1470 MHz FD-LTE 5MHz Channel, 1RB, 24RB offset, +55C, 5k hours	+29	dBm	
	1710 MHz – 2300 MHz FD-LTE 5MHz Channel, 1RB, 24RB offset, +55C, 5k hours	+29		
	2300 MHz – 2400 MHz TD-LTE 5MHz Channel, 1RB, 24RB offset, +55C, 5k hours	+32		
	2496 MHz – 2690 MHz TD-LTE 5MHz Channel, 1RB, 24RB offset, +55C, 5k hours	+32		
RF Input Power (Pin5, UHB/5G WiFi)	3300 MHz – 5000 MHz TD-LTE 5MHz Channel, 1RB, 24RB offset, +55C, 5k hours	+32	dBm	
	5150 MHz – 5925 MHz CW, +55C, 5k hours	+24		
RF Input Power (Pin1, ANT)	1427.9 MHz – 1518 MHz	CW, +55C, 5k hours	+15	dBm
	1559 MHz – 1606 MHz			
	1710 MHz – 2400 MHz			
	2496 MHz – 2690 MHz			
	3300 MHz – 5925 MHz			

Operation of this device outside the parameter ranges given above may cause permanent damage.

Electrical Specifications⁽¹⁾ L1 GNSS - Antenna

Parameter	Conditions	Min.	Typ.	Max.	Units
Insertion Loss	1559.05 MHz – 1563.15 MHz	-	1.2 ⁽²⁾	1.7	dB
	1574.39 MHz – 1576.45 MHz	-	0.9 ⁽²⁾	1.1	
	1597.55 MHz – 1605.89 MHz	-	1.3 ⁽²⁾	1.9	
VSWR (GNSS)	1559.05 MHz – 1563.15 MHz	-	1.2:1	2.0:1	-
	1574.39 MHz – 1576.45 MHz	-	1.1:1	2.0:1	
	1597.55 MHz – 1605.89 MHz	-	1.3:1	2.0:1	
VSWR (ANT)	1559.05 MHz – 1563.15 MHz	-	1.2:1	2.0:1	-
	1574.39 MHz – 1576.45 MHz	-	1.1:1	2.0:1	
	1597.55 MHz – 1605.89 MHz	-	1.4:1	2.0:1	
Attenuation	10 MHz – 960 MHz	46	49	-	dB
	777 MHz – 787 MHz	48	50	-	
	1427.9 MHz – 1462.9 MHz	49	53	-	
	1695 MHz – 1710 MHz	56	63	-	
	1710 MHz – 1785 MHz	54	62	-	
	1850 MHz – 1910 MHz	51	66	-	
	1910 MHz – 1980 MHz	45	69	-	
	2010 MHz – 2025 MHz	45	64	-	
	2305 MHz – 2315 MHz	45	51	-	
	2403 MHz – 2481 MHz ⁽³⁾	42	46	-	
	2500 MHz – 2570 MHz	40	44	-	
	2570 MHz – 2690 MHz	39	42	-	
	3400 MHz – 3600 MHz	43	46	-	
	4400 MHz – 4900 MHz	43	53	-	
5150 MHz – 5925 MHz	25	46	-		

Notes:

1. All specifications are based on the applications circuit and Min/Max is specified over -30°C to +85°C unless otherwise noted.
2. Typical specified as average at room temperature
3. Integrated over each 18MHz WiFi channel

Electrical Specifications⁽¹⁾ MHB - Antenna

Parameter	Conditions	Min.	Typ.	Max.	Units
Insertion Loss	1427.9 MHz – 1518 MHz	-	0.8 ⁽²⁾	1.9	dB
	1710 MHz – 2200 MHz	-	0.9 ⁽²⁾	1.3	
	2300 MHz – 2370 MHz	-	1.0 ⁽²⁾	1.4	
	2370 MHz – 2390 MHz	-	1.0 ⁽²⁾	1.4	
	2390 MHz – 2400 MHz	-	1.0 ⁽²⁾	1.4	
	2496 MHz – 2500 MHz	-	1.1 ⁽²⁾	1.5	
	2500 MHz – 2505 MHz	-	1.1 ⁽²⁾	1.5	
	2505 MHz – 2690 MHz	-	1.2 ⁽²⁾	2.2	
VSWR (MHB)	1427.9 MHz – 1470 MHz	-	1.3:1	2.0:1	-
	1470 MHz – 1518 MHz	-	1.9:1	2.5:1	
	1710 MHz – 2200 MHz	-	1.4:1	2.0:1	
	2300 MHz – 2370 MHz	-	1.3:1	2.0:1	
	2370 MHz – 2390 MHz	-	1.2:1	2.0:1	
	2390 MHz – 2400 MHz	-	1.2:1	2.0:1	
	2496 MHz – 2690 MHz	-	1.2:1	2.0:1	
VSWR (ANT)	1427.9 MHz – 1518 MHz	-	1.6:1	2.0:1	-
	1710 MHz – 2200 MHz	-	1.5:1	2.0:1	
	2300 MHz – 2370 MHz	-	1.3:1	2.0:1	
	2370 MHz – 2390 MHz	-	1.3:1	2.0:1	
	2390 MHz – 2400 MHz	-	1.3:1	2.0:1	
	2496 MHz – 2690 MHz	-	1.2:1	2.0:1	
Attenuation	1559 MHz – 1606 MHz	18	22	-	dB
	3300 MHz – 5000 MHz	13	20	-	
	5150 MHz – 5925 MHz	17	25	-	

Notes:

1. All specifications are based on the applications circuit and Min/Max is specified over -30°C to +85°C unless otherwise noted.
2. Typical specified as average at room temperature

Electrical Specifications⁽¹⁾ UHB/5G WIFI - Antenna

Parameter	Conditions	Min.	Typ.	Max.	Units
Insertion Loss	3300 MHz – 3400 MHz	-	1.3 ⁽²⁾	2.5	dB
	3400 MHz – 3800 MHz	-	0.8 ⁽²⁾	1.7	
	3800 MHz – 4200 MHz	-	0.7 ⁽²⁾	1.0	
	4400 MHz – 5000 MHz	-	0.6 ⁽²⁾	1.2	
	5150 MHz – 5925 MHz	-	0.8 ⁽²⁾	2.0	
VSWR (UHB/5G WiFi)	3300 MHz – 5000 MHz	-	1.4:1	2.0:1	-
	5150 MHz – 5925 MHz	-	1.5:1	2.0:1	
VSWR (ANT)	3300 MHz – 5000 MHz	-	1.4:1	2.0:1	
	5150 MHz – 5925 MHz	-	1.5:1	2.0:1	
Attenuation	1427.9 MHz – 1518 MHz	26	28	-	dB
	1559 MHz – 1606 MHz	26	28	-	
	1710 MHz – 2400 MHz	18	23	-	
	2496 MHz – 2690 MHz	18	25	-	
	10300 MHz – 11850 MHz	18	33	-	

Notes:

1. All specifications are based on the applications circuit and Min/Max is specified over -30°C to +85°C unless otherwise noted.
2. Typical specified as average at room temperature

Electrical Specifications⁽¹⁾ Isolation

Parameter		Conditions	Min.	Typ.	Max.	Units
Isolation	GNSS – MHB	1559 MHz – 1606 MHz	18	23	-	dB
		1427.9 MHz – 1518 MHz	41	45	-	
		1710 MHz – 2400 MHz	35	47	-	
		2496 MHz – 2690 MHz	38	42	-	
	GNSS – UHB/5G WiFi	1559 MHz – 1606 MHz	27	29	-	
		3300 MHz – 5000 MHz	42	46	-	
		5150 MHz – 5925 MHz	35	45	-	
	MHB – UHB/5G WiFi	1427.9 MHz – 1518 MHz	28	31	-	
		1710 MHz – 2400 MHz	20	24	-	
		2496 MHz – 2690 MHz	18	26	-	
		3300 MHz – 5000 MHz	12	20	-	
			5150 MHz – 5925 MHz	26	30	

Notes:

1. All specifications are based on the applications circuit and Min/Max is specified over -30°C to +85°C unless otherwise noted.

QM28017EVB PCB Information

Layer	Name	Material	Thickness	Constant	Board Layer Stack
1	Top Overlay				
2	Top Solder	Solder Resist	0.79mil	3.5	
3	L1	Copper	0.70mil		
4	Dielectric1	FR-408HR	4.10mil	3.3	
5	L2	Copper	0.70mil		
6	Dielectric 2	FR-408HR	26.00mil	3.6	
7	L3	Copper	0.70mil		
8	Dielectric 3	FR-408HR	4.10mil	3.3	
9	L4	Copper	0.70mil		
10	Bottom Solder	Solder Resist	0.79mil	3.5	
11	Bottom Overlay				

Total thickness: 40 MILS +/-10%

Where:

- J1 = GNSS
- J2 = ANT
- J3 = MHB
- J4 = UHB/5G

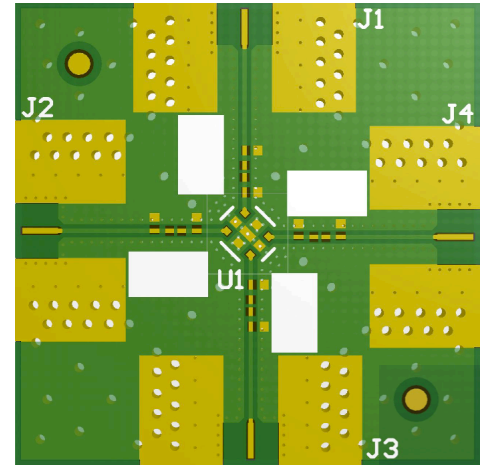

Application Circuit Schematic

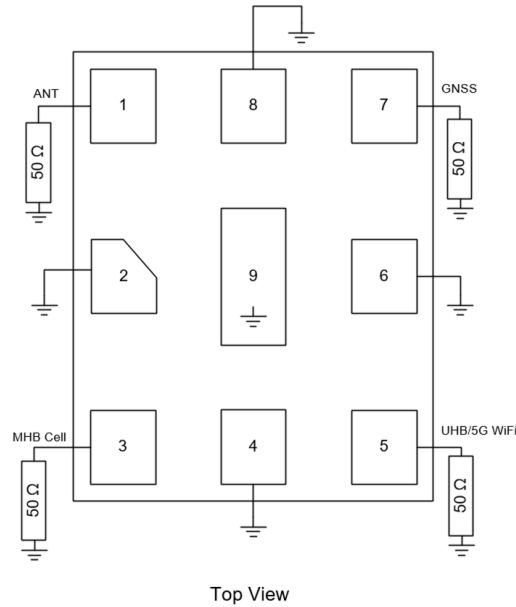

Note:

1. All RF ports internally matched to 50 ohm impedance
2. Recommend connecting all ground pins together on PCB
3. Recommend adding Pi network close to each RF port for phone level tuning/optimization

Bill of Materials

Ref. Des.	Value	Description	Manuf.	Part number
U1	N/A	GNSS, MHB and UHB/5G WiFi Antennaplexer	Qorvo	QM28017
PCB	N/A	Printed Circuit Board		QM28017-4000

GNSS Insertion Loss and Attenuation Plots

Test conditions unless otherwise noted: Temp. = +25 °C

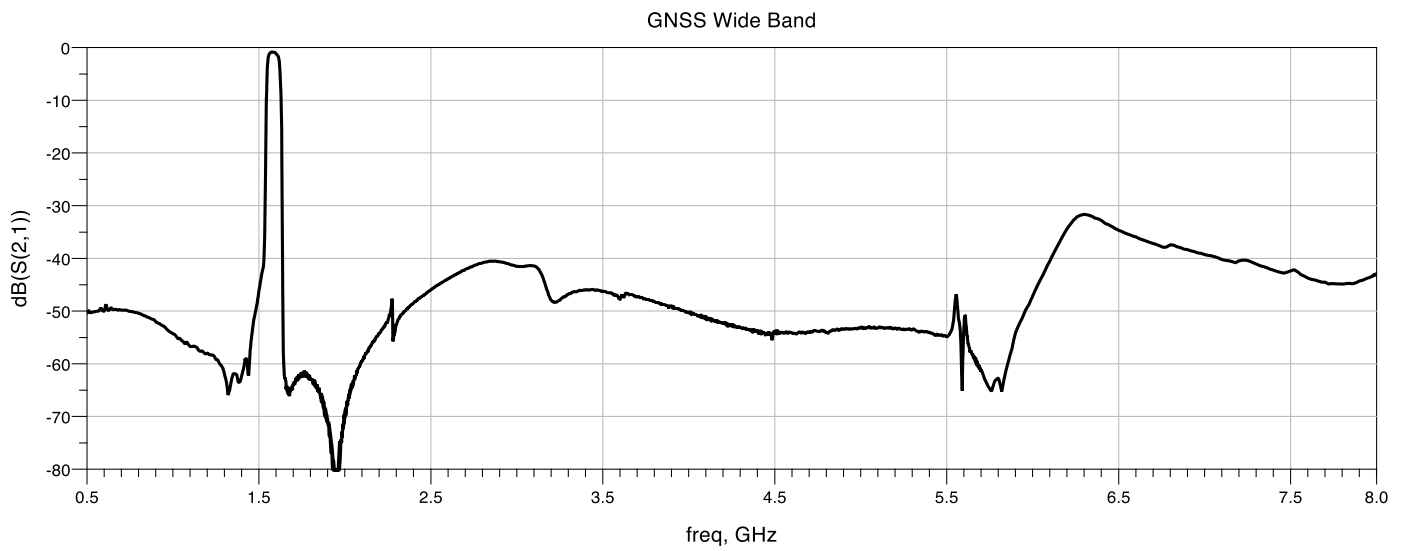
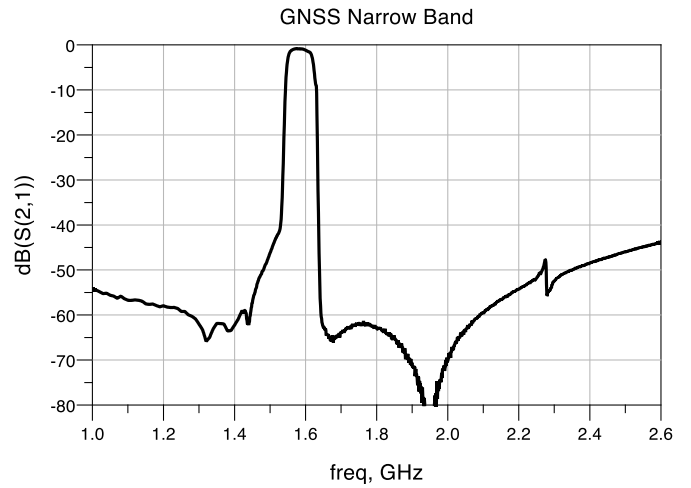
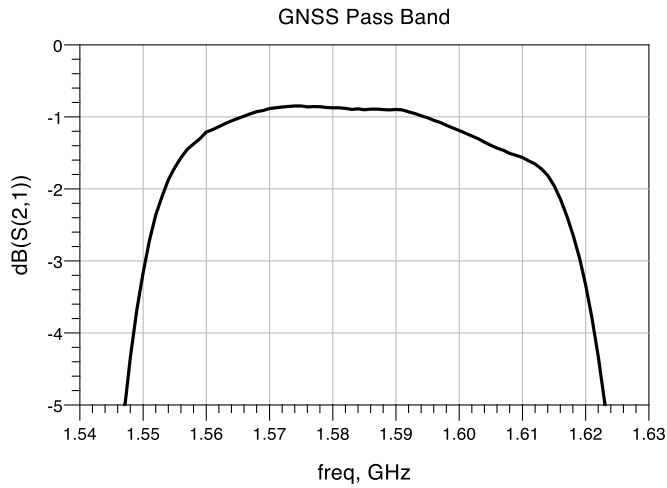

GNSS Return Loss and Impedance Plots

Test conditions unless otherwise noted: Temp. = +25 °C

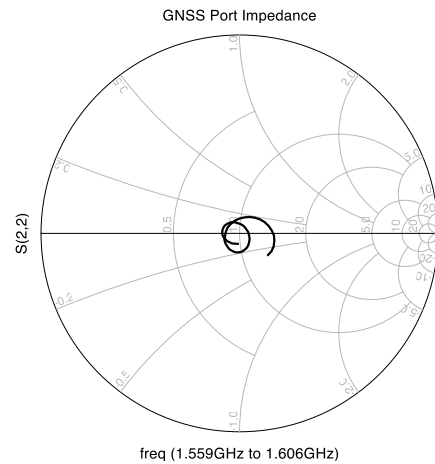
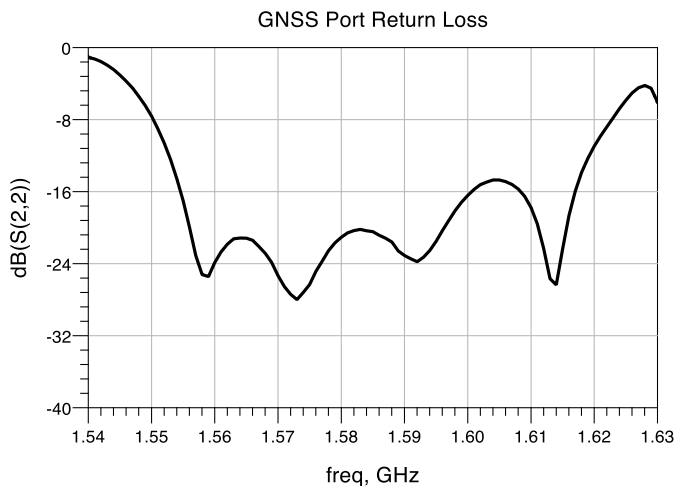
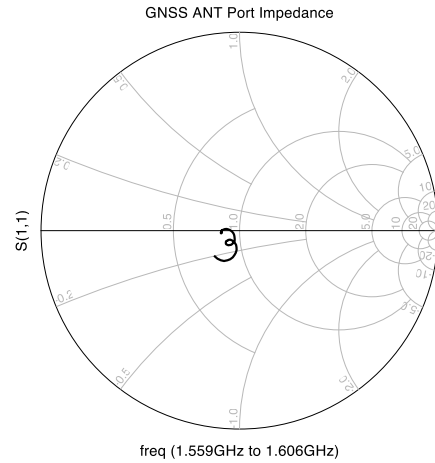
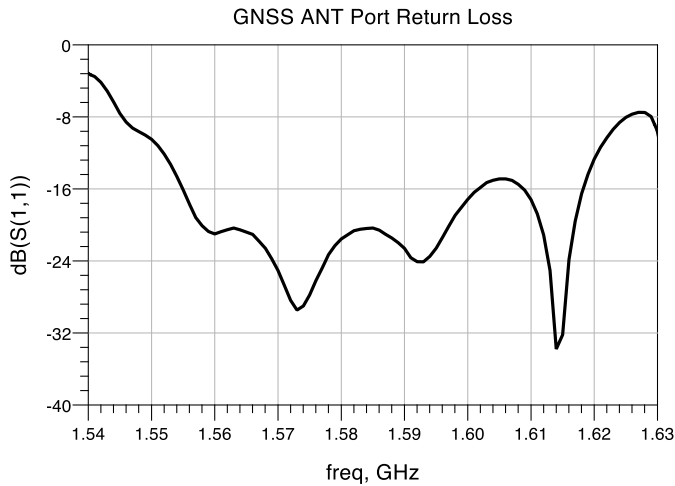

MHB Insertion Loss and Attenuation Plots

Test conditions unless otherwise noted: Temp. = +25 °C

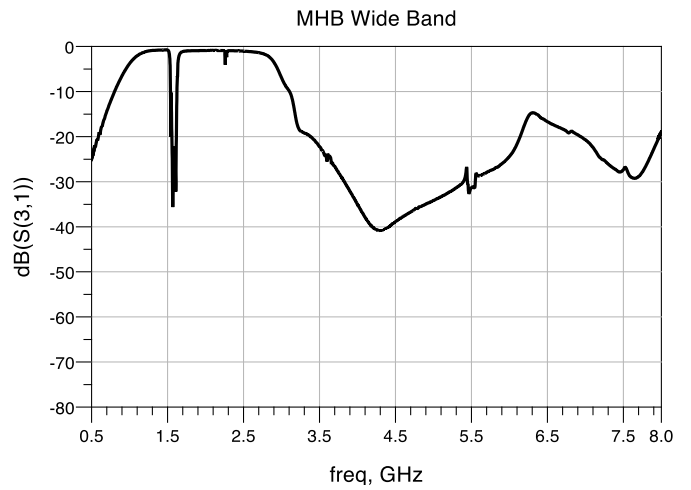
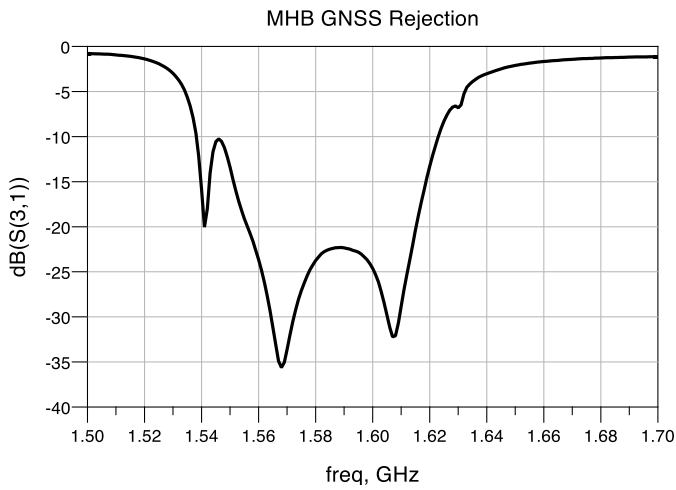
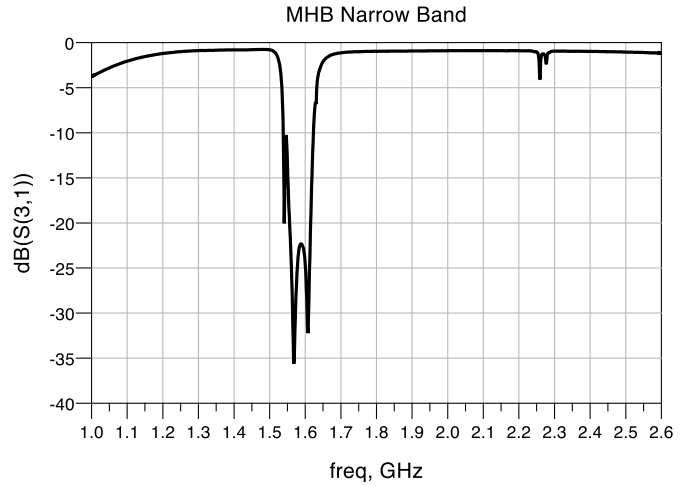
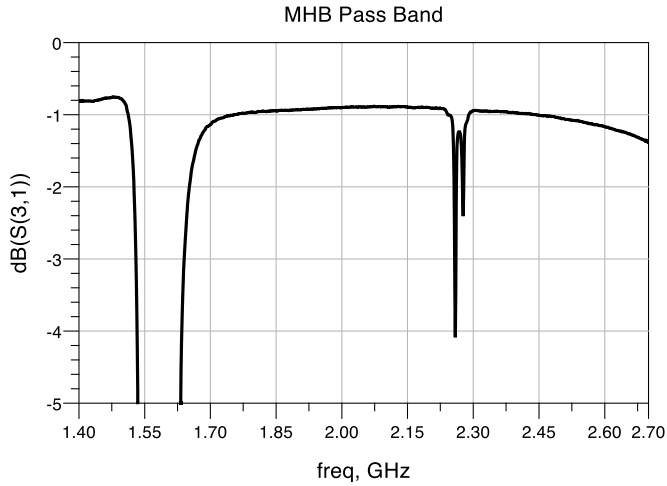

MHB Return Loss Plots

Test conditions unless otherwise noted: Temp. = +25 °C

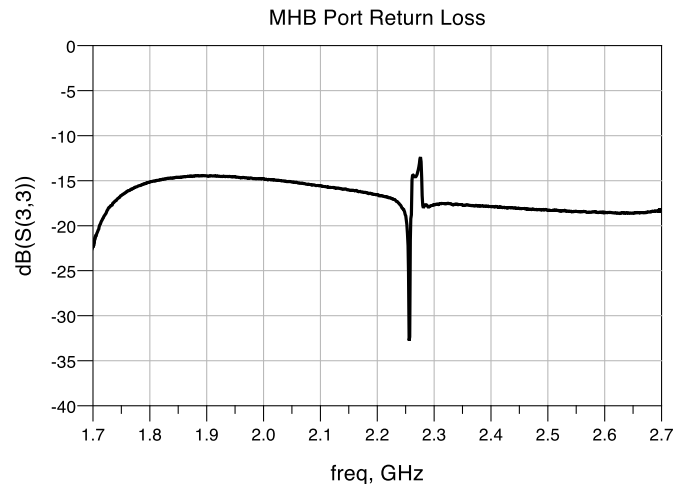
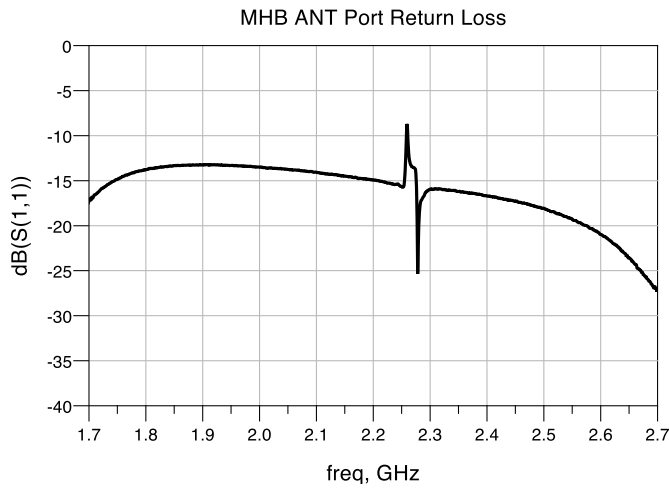
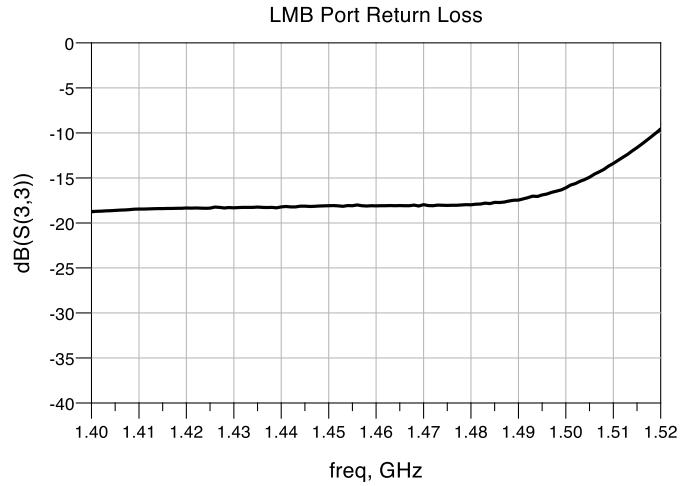
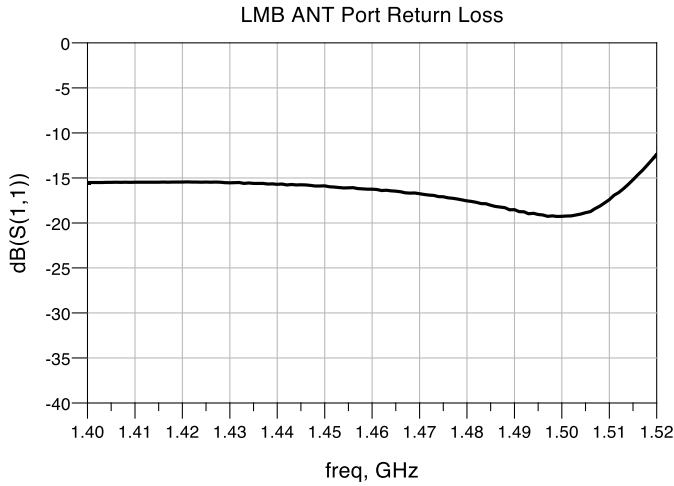

MHB Impedance Plots

Test conditions unless otherwise noted: Temp. = +25 °C

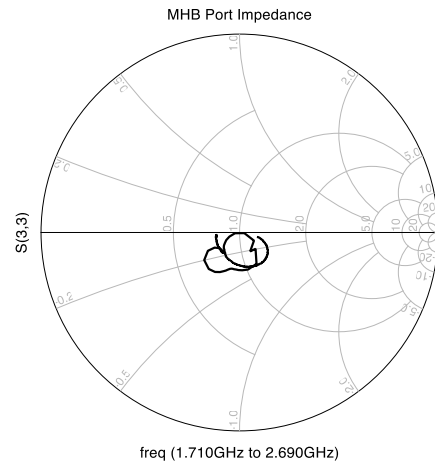
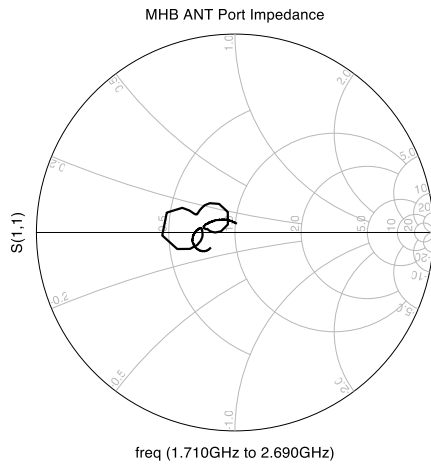
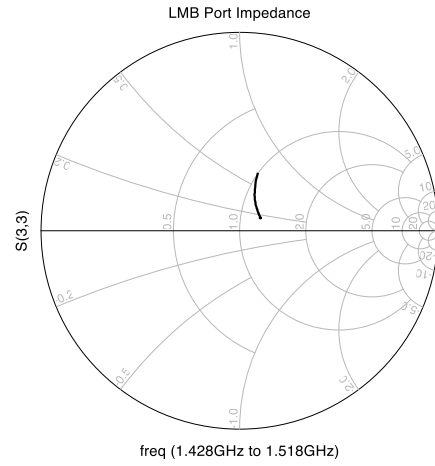
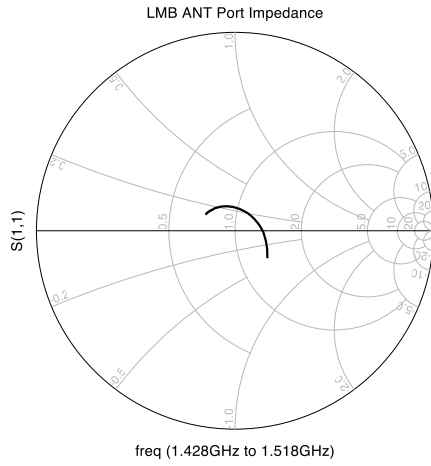

UHB/5G WiFi Insertion Loss and Attenuation Plots

Test conditions unless otherwise noted: Temp. = +25 °C

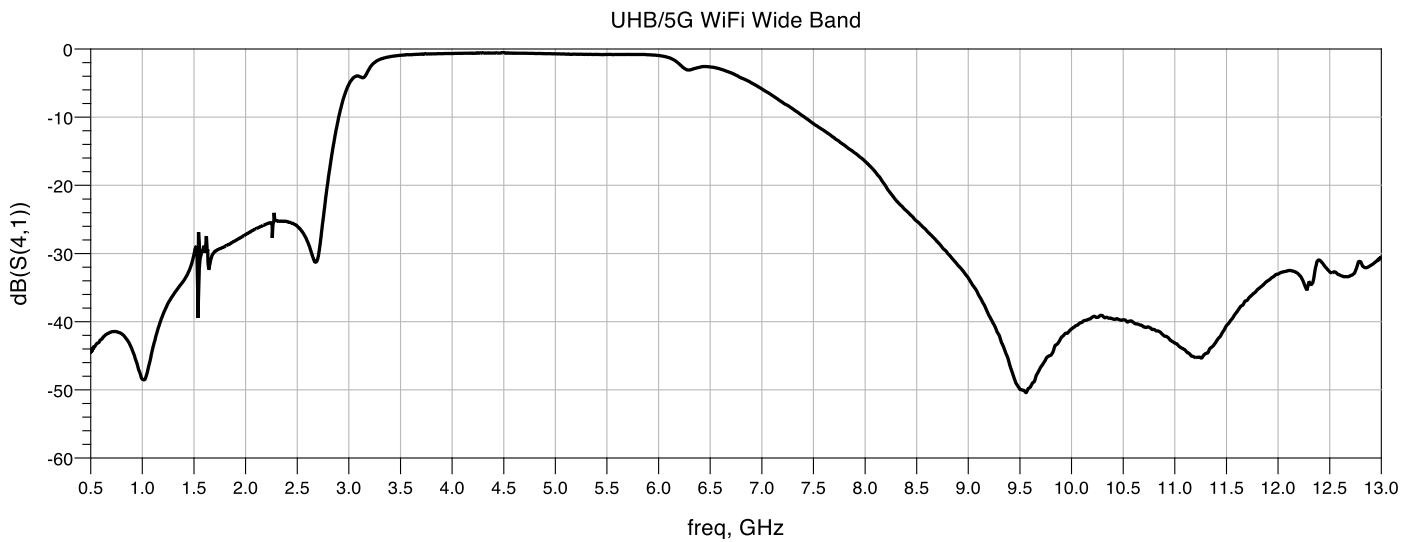
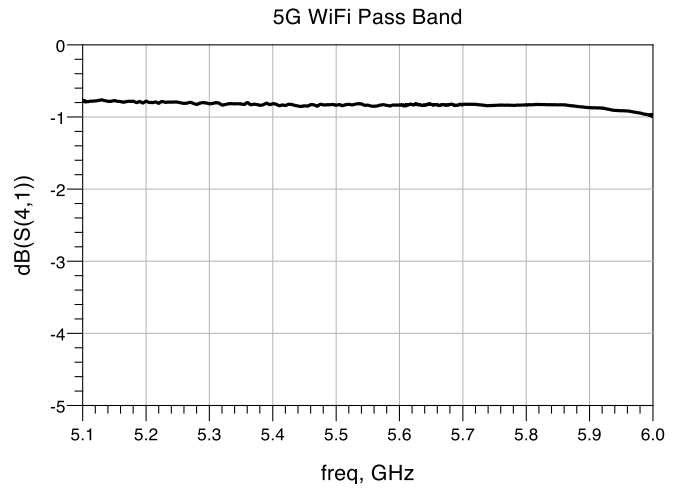
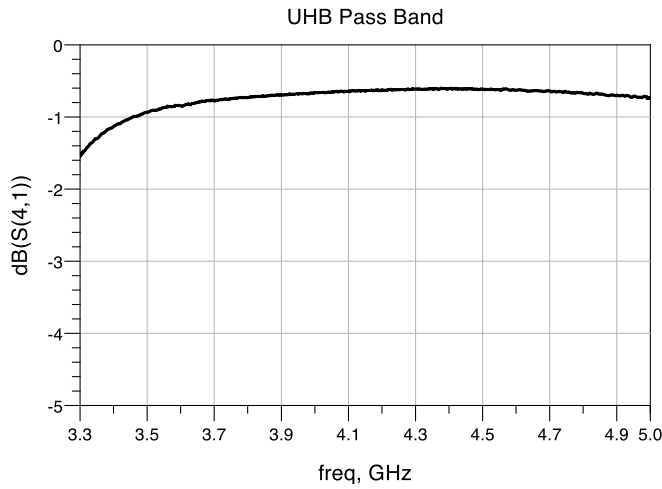

UHB/5G WiFi Return Loss and Impedance Plots

Test conditions unless otherwise noted: Temp. = +25 °C

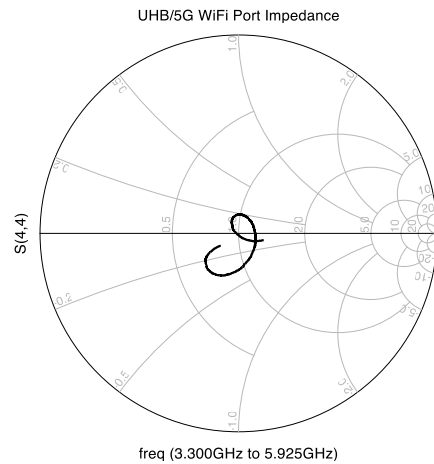
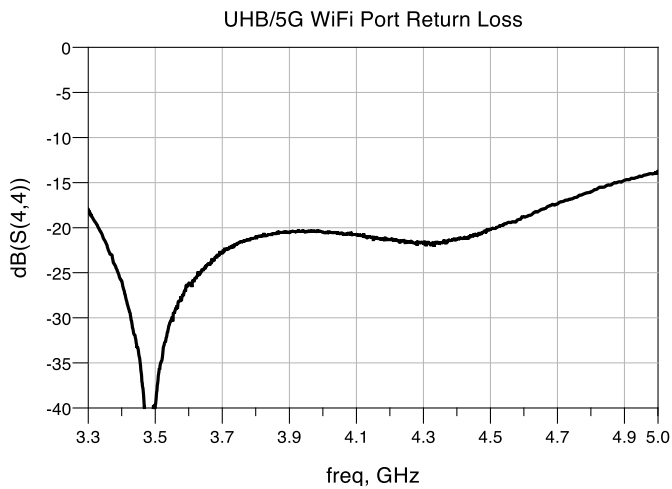
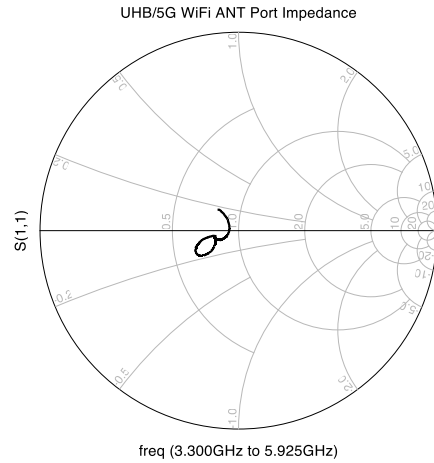
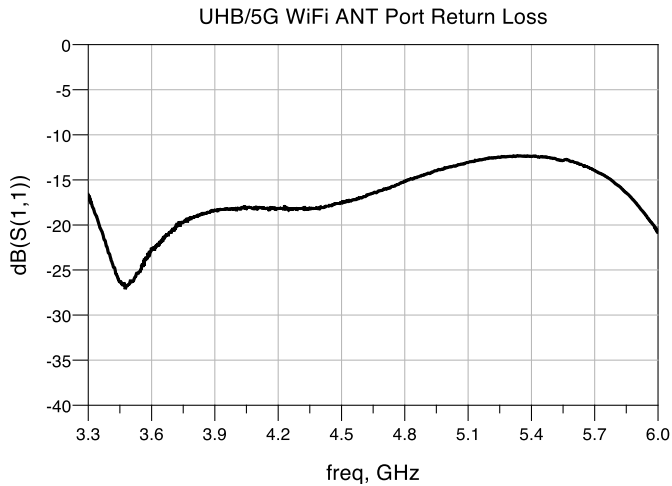

Isolation Plots

Test conditions unless otherwise noted: Temp. = +25 °C

GNSS to MHB Isolation

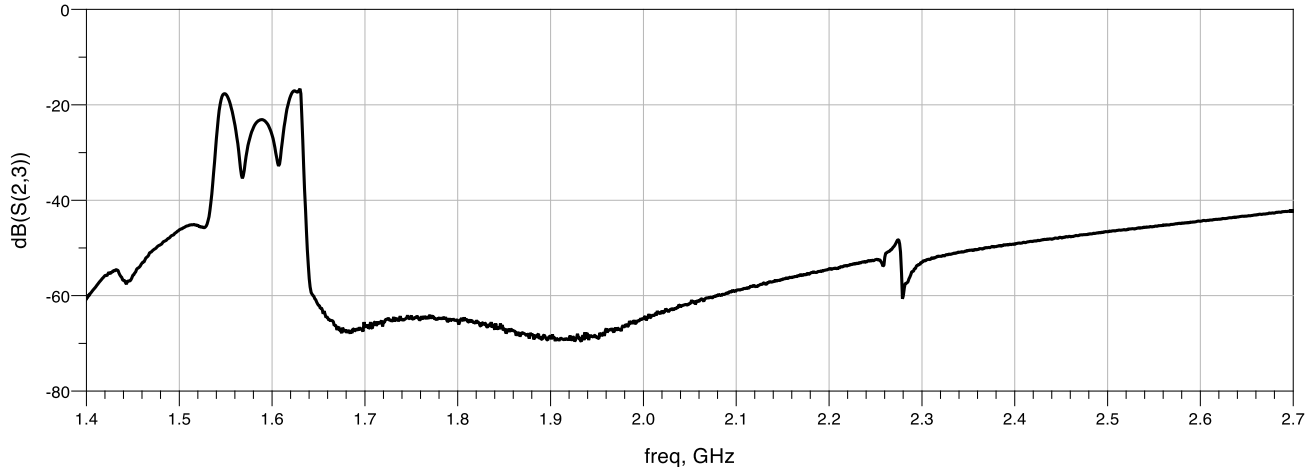

GNSS to UHB/5G WiFi Isolation

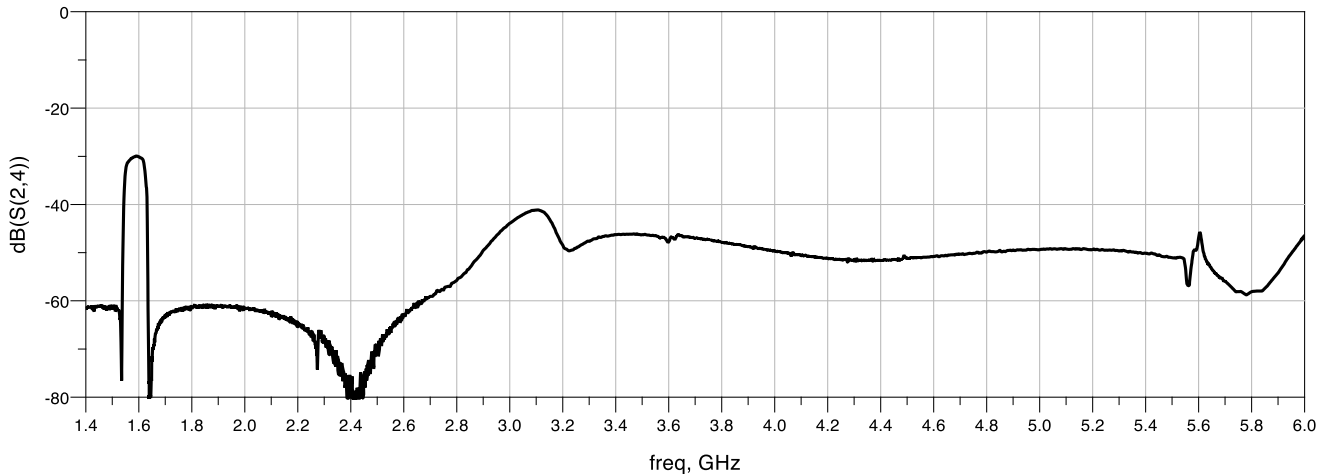

MHB to UHB/5G WiFi Isolation

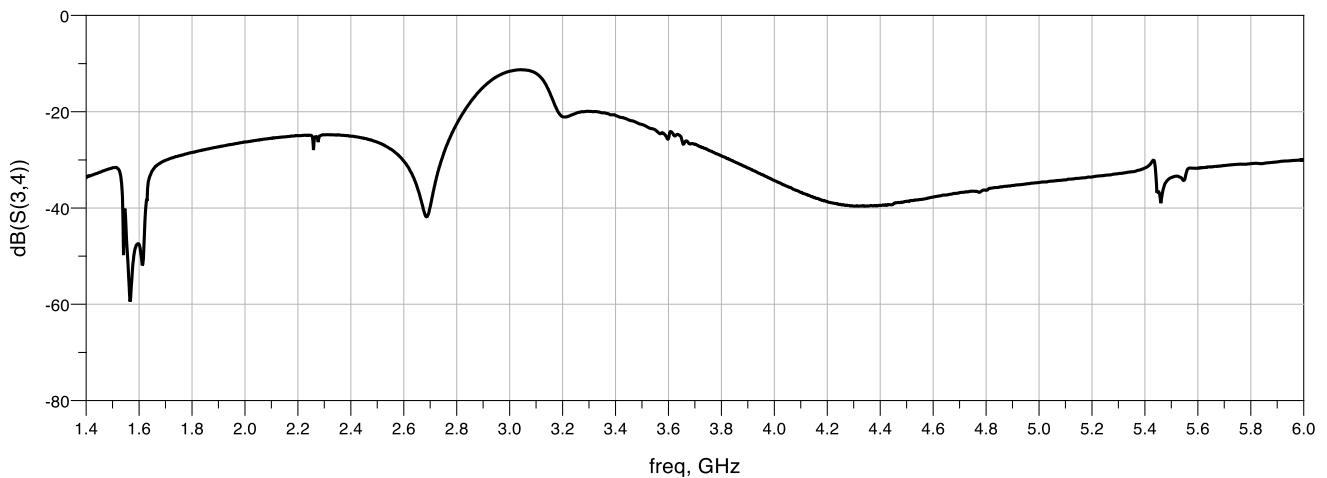

Pin Configuration and Description

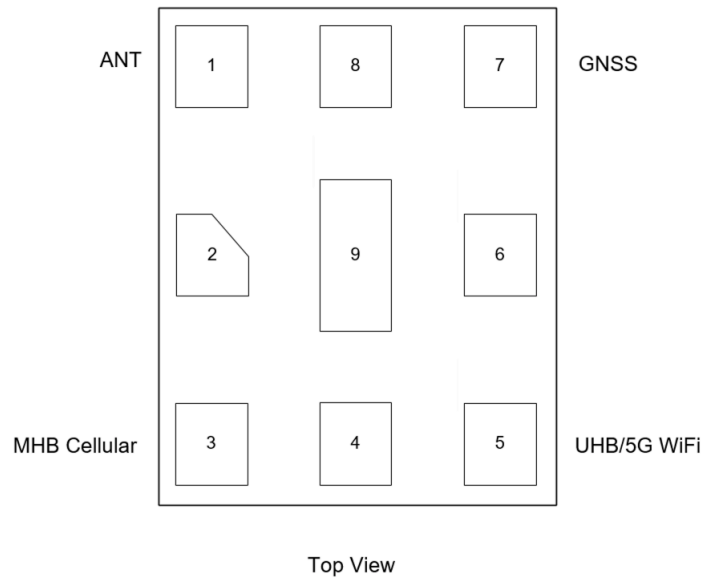

Pin Number	Label	Description
1	ANT	Antenna Port
3	MHB Cellular	MHB Cellular Port
5	UHB/5G WIFI	UHB/5G WIFI Port
7	GNSS	GNSS Port
2, 4, 6, and 8	GND	Ground
9	GND	Package Ground

Part Marking and Package Outline Dimensions

Part Marking Diagram – Top View

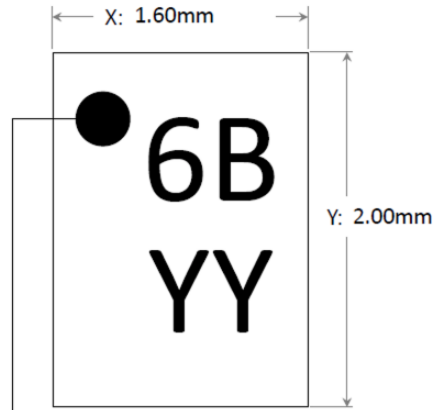

Pin 1 Indicator
Trace Code to be assigned by SubCon
"6B" is Product Code and "YY" is Trace Code

Package Outline Dimension Drawing

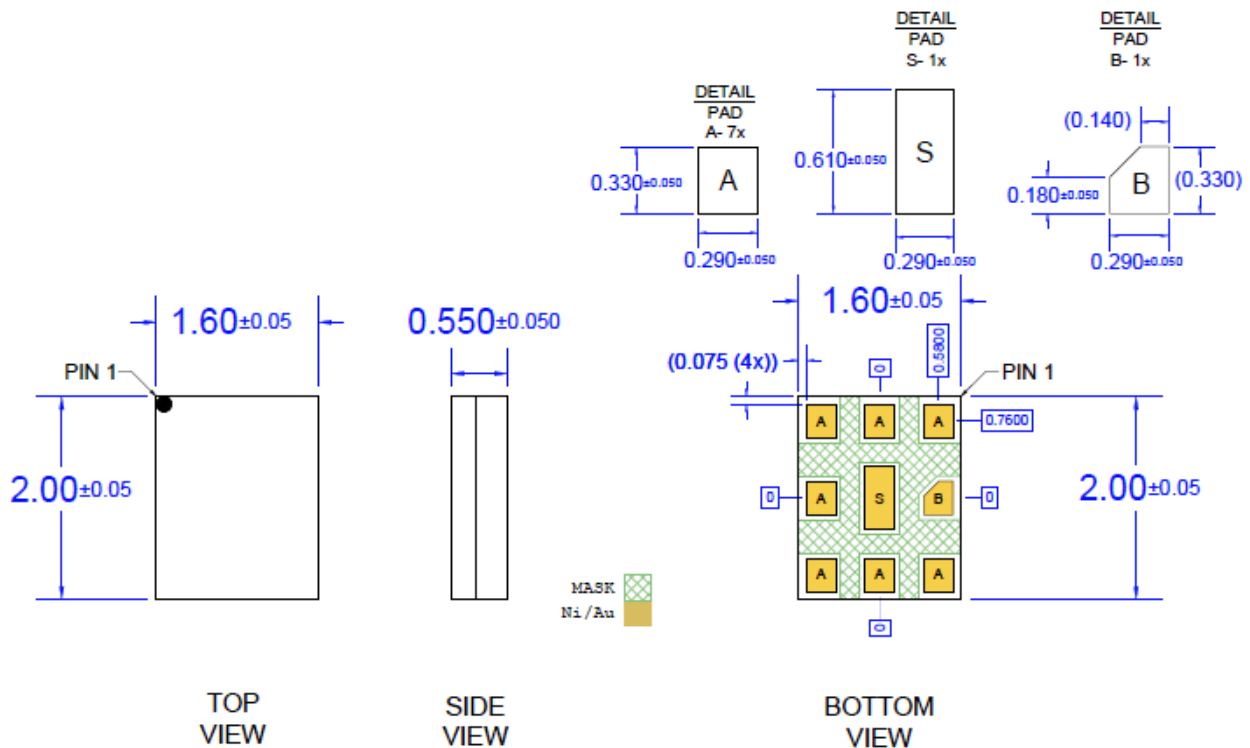

Notes:

1. All dimensions are in millimeters.
2. Dimension and tolerance formats conform to ASME Y14.4M-1994.
3. The terminal #1 identifier and terminal numbering conform to JESD 95-1 SPP-012

Land Pattern and Mask Dimensions

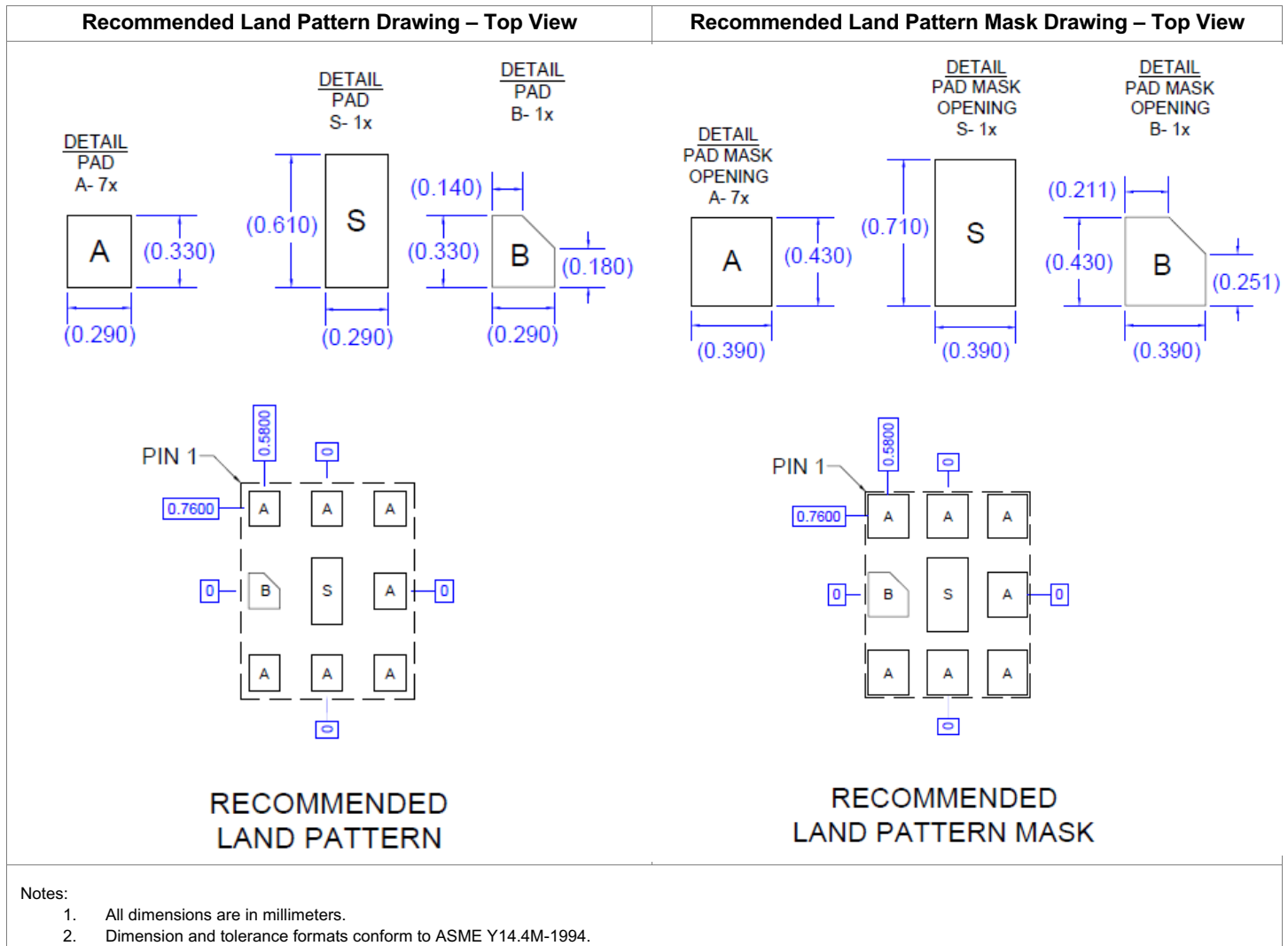

Tape and Reel Information

Feature	Measure	Symbol	Size (mm)	Feature	Measure	Symbol	Size (mm)
Flange	Diameter	D1	330.0	Cavity	Length	Ao	1.8
	Thickness	W2	14.4		Width	Bo	2.2
	Space Between Flange	W1	8.4		Depth	Ko	0.8
Hub	Outer Diameter	D2	102.0	Centerline Distance	Cavity to Perforation (Length)	P2	2.0
	Arbor Hole Diameter	D3	13.0		Cavity to Perforation (Width)	P3	3.5
	Key Slit Width	B	2.0	Carrier Tape	Width	W	8
	Key Slit Diameter	D4	20.0				

(Unless otherwise specified, all dimension tolerances per EIA-481)

Handling Precautions

PARAMETER	RATING	STANDARD
ESD – Human Body Model (HBM)	Class 1B	ESDA/JEDEC JS-001
ESD – Charged Device Model (CDM)	Class C3	ESDA/JEDEC JS-002
MSL – Moisture Sensitivity Level	Level 3	IPC/JEDEC J-STD-020



Caution!

ESD sensitive device

Solderability

Compatible with both lead-free (260 °C max. reflow temperature) and tin/lead (245 °C max. reflow temperature) soldering processes.

Package lead plating: Electrolytic plated Au over Ni

RoHS Compliance

This part is compliant with the 2011/65/EU RoHS directive (Restrictions on the Use of Certain Hazardous Substances in Electrical and Electronic Equipment), as amended by Directive 2015/863/EU.

This product also has the following attributes:

- Lead free
- Halogen Free (Chlorine, Bromine)
- Antimony Free
- TBBP-A (C₁₅H₁₂Br₄O₂) Free
- PFOS Free
- SVHC Free
- Qorvo Green



Contact Information

For the latest specifications, additional product information, worldwide sales and distribution locations:

Web: www.qorvo.com

Tel: 1-844-890-8163

Email: customer.support@qorvo.com

Important Notice

The information contained herein is believed to be reliable; however, Qorvo makes no warranties regarding the information contained herein and assumes no responsibility or liability whatsoever for the use of the information contained herein. All information contained herein is subject to change without notice. Customers should obtain and verify the latest relevant information before placing orders for Qorvo products. The information contained herein or any use of such information does not grant, explicitly or implicitly, to any party any patent rights, licenses, or any other intellectual property rights, whether with regard to such information itself or anything described by such information. **THIS INFORMATION DOES NOT CONSTITUTE A WARRANTY WITH RESPECT TO THE PRODUCTS DESCRIBED HEREIN, AND QORVO HEREBY DISCLAIMS ANY AND ALL WARRANTIES WITH RESPECT TO SUCH PRODUCTS WHETHER EXPRESS OR IMPLIED BY LAW, COURSE OF DEALING, COURSE OF PERFORMANCE, USAGE OF TRADE OR OTHERWISE, INCLUDING THE IMPLIED WARRANTIES OF MERCHANTABILITY AND FITNESS FOR A PARTICULAR PURPOSE.**

Without limiting the generality of the foregoing, Qorvo products are not warranted or authorized for use as critical components in medical, life-saving, or life-sustaining applications, or other applications where a failure would reasonably be expected to cause severe personal injury or death.

Copyright 2016 © Qorvo, Inc. | Qorvo is a registered trademark of Qorvo, Inc.

REVISION HISTORY

Revision	Date (YYYYMMDD)	Description
D	20201006	Production Release

Mouser Electronics

Authorized Distributor

Click to View Pricing, Inventory, Delivery & Lifecycle Information:

[Qorvo:](#)

[QM28017TR13](#)