

TOSHIBA Bi-CD Integrated Circuit Silicon Monolithic

TB67B008FTG, TB67B008FNG TB67B008AFTG, TB67B008AFNG TB67B008BFTG, TB67B008BFNG TB67B008CFTG, TB67B008CFNG

Sensorless PWM Driver for 3-Phase Brushless Motors

The TB67B008 series is a three-phase PWM chopper control driver for sensorless brushless motor. It controls motor rotation speed by changing the PWM duty cycle, based on the speed control input.

TB67B008FTG/TB67B008FNG: Rotation speed detecting signal (FG_OUT) is assigned to 8pin and 23pin. It is 1ppr (1 pulse/1 electrical angle).

TB67B008AFTG/TB67B008AFNG: Lock detecting signal (LD_OUT) is assigned to 8 pin and 23 pin. It is high level in normal state and low level in abnormal state.

TB67B008BFTG/TB67B008BFNG: Rotation speed detecting signal (FG_OUT) is assigned to 8pin and 23pin. It is 3ppr (3 pulses/1 electrical angle).

TB67B008CFTG/TB67B008CFNG: Lock detecting signal (LD_OUT) is assigned to 8 pin and 23 pin. It is low level in normal state and high level in abnormal state.

The TB67B008FTG, TB67B008AFTG, TB67B008BFTG, and TB67B008CFTG is a product of WQFN24 package.

The TB67B008FNG, TB67B008AFNG, TB67B008BFNG, and TB67B008CFNG is a product of SSOP24 package.

Products can be selected as usage.

Features

- Sensorless drive in three-phase full-wave
- PWM chopper control
- Control based on the pulse duty input
- Output current: Absolute maximum rating: 3 A
- Power supply: Absolute maximum rating: 25 V
- Adjustable output PWM duty cycle
- Selectable lead angle control function
- Soft switching is available in overlapping commutation (150°)
- Rotation speed detecting signal (FG_OUT): 1 ppr: TB67B008FTG (8 pin)/TB67B008FNG (23 pin)
- Lock detecting signal (LD_OUT): High in normal : Low in abnormal: TB67B008AFTG (8 pin) / TB67B008AFNG (23 pin)
- Rotation speed detecting signal (FG_OUT): 3 ppr: TB67B008BFTG (8pin)/TB67B008BFNG (23 pin)
- Lock detecting signal (LD_OUT): Low in normal: High in abnormal: TB67B008CFTG (8 pin) / TB67B008CFNG (23 pin)
- Adjustable startup settings
- Selectable forced commutation frequency control function
- Selectable PWM frequency
- Restart function
- Over current detection circuit (ISD)
- Thermal shutdown circuit (TSD)
- Under voltage lock circuit (UVLO)
- Current limiter circuit

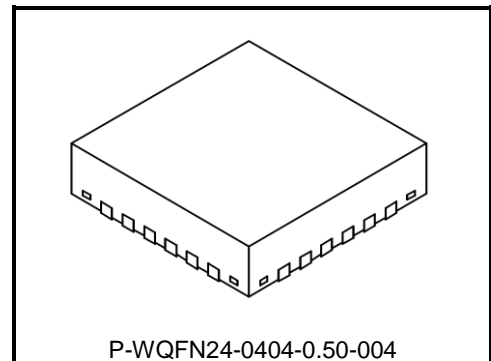

Weight: 0.04 g (typ.)

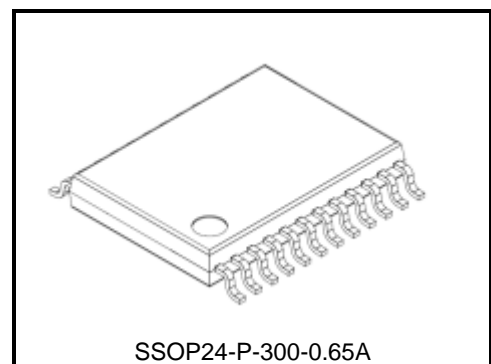

Weight: 0.13 g (typ.)

Pin Assignment

- TB67B008FTG/TB67B008AFTG/TB67B008BFTG/TB67B008CFTG

<Top View>

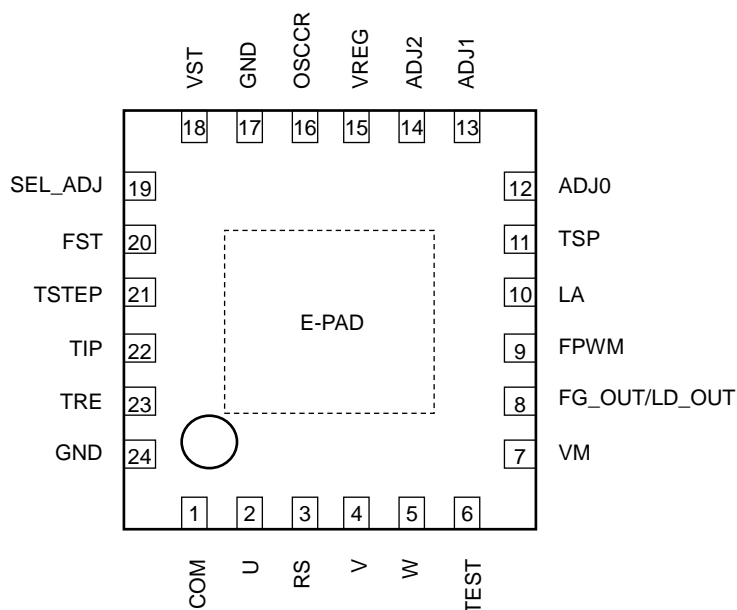

Note: Design the pattern in consideration of the heat design because the back side (E-PAD (2.6 mm×2.6 mm)) has the role of heat radiation. (A metal on the back side of a package (E-PAD) should be connected to GND because it is connected to the back of the chip in the package electrically.)

- TB67B008FNG/TB67B008AFNG/TB67B008BFNG/TB67B008CFNG

<Top View>

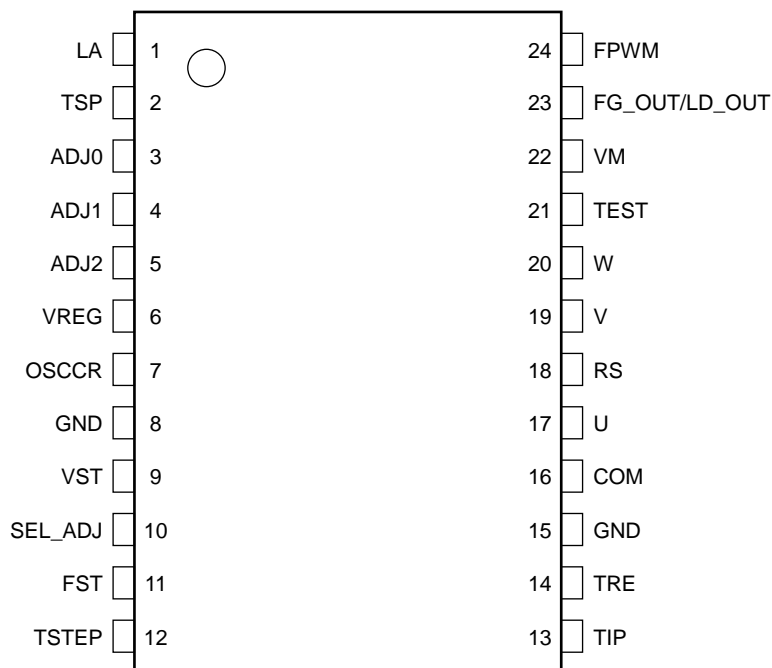

Pin Description

- TB67B008FTG/TB67B008AFTG/TB67B008BFTG/TB67B008CFTG (WQFN24)

Pin No.	Symbol	I/O	Description
1	COM	I	Connection pin for the center tap of the motor pin
2	U	O	U-phase output pin
3	RS	—	Connection pin for output current detecting resistance
4	V	O	V-phase output pin
5	W	O	W-phase output pin
6	TEST	—	Test pin (Connect to ground)
7	VM	—	Motor power supply pin
8	FG_OUT	O	TB67B008FTG/TB67B008BFTG Rotation speed detection signal output pin (open-drain)
	LD_OUT	O	TB67B008AFTG/TB67B008CFTG Lock detecting signal output pin (open-drain)
9	FPWM	I	Output PWM frequency select input pin
10	LA	I	Lead angle setting input pin
11	TSP	I	Speed command input pin (PWM duty cycle control) in sensorless drive mode
12	ADJ0	I	Adjusting pin for characteristics of speed command input
13	ADJ1	I	Adjusting pin 1 for characteristics of output PWM duty cycle
14	ADJ2	I	Adjusting pin 2 for characteristics of output PWM duty cycle
15	VREG	—	Reference voltage output
16	OSCCR	—	Internal OSC setting pin
17	GND	—	Ground connection pin
18	VST	I	Output PWM duty cycle setting pin in DC excitation and forced commutation modes
19	SEL_ADJ	I	Output PWM duty cycle function setting input pin
20	FST	I	Forced commutation frequency select input pin
21	TSTEP	—	Connection pin for a capacitor to set the Output PWM duty cycle increasing time
22	TIP	—	Connection pin for a capacitor to set the DC excitation time
23	TRE	—	Connection pin for a capacitor to set the restart time
24	GND	—	Ground connection pin

- TB67B008FNG/TB67B008AFNG/TB67B008BFNG/TB67B008CFNG (SSOP24)

Pin No.	Symbol	I/O	Description
1	LA	I	Lead angle setting input pin
2	TSP	I	Speed command input pin (PWM duty cycle control) in sensorless drive mode
3	ADJ0	I	Adjusting pin for characteristics of speed command input
4	ADJ1	I	Adjusting pin 1 for characteristics of output PWM duty cycle
5	ADJ2	I	Adjusting pin 2 for characteristics of output PWM duty cycle
6	VREG	—	Reference voltage output pin
7	OSCCR	—	Internal OSC setting pin
8	GND	—	Ground connection pin
9	VST	I	Output PWM duty cycle setting pin in DC excitation and forced commutation modes
10	SEL_ADJ	I	Output PWM duty cycle function setting input pin
11	FST	I	Forced commutation frequency select input pin
12	TSTEP	—	Connection pin for a capacitor to set the Output PWM duty cycle increasing time
13	TIP	—	Connection pin for a capacitor to set the DC excitation time
14	TRE	—	Connection pin for a capacitor to set the restart time
15	GND	—	Ground connection pin
16	COM	I	Connection pin for the center tap of the motor pin
17	U	O	U-phase output pin
18	RS	—	Connection pin for output current detecting resistance
19	V	O	V-phase output pin
20	W	O	W-phase output pin
21	TEST	—	Test pin (Connect to ground)
22	VM	—	Motor power supply pin
23	FG_OUT	O	TB67B008FNG/TB67B008BFNG Rotation speed detection signal output pin (open-drain)
	LD_OUT	O	TB67B008AFNG/TB67B008CFNG Lock detecting signal output pin (open-drain)
24	FPWM	I	Output PWM frequency select input pin

Functional Description

In this chapter, the equivalent circuit diagrams may be simplified or some parts of them may be omitted for explanatory purposes.

Timing charts may be simplified for explanatory purposes.

1. Sensorless Drive Mode

Based on the TSP input for a startup operation, the rotor is aligned to a known position in DC excitation mode.

Then, the forced commutation signal is generated to start the motor rotation. As the motor rotates, the induced voltage occurs in each phase of the coil.

When a signal indicating the polarity of each phase voltage which includes the induced voltage is detected as a position signal, the motor driving signal is automatically switched from the forced commutation signal to the normal commutation signal that is based on the position signal (induced voltage). Then, a brushless motor starts running in sensorless commutation mode.

1)Timing chart when the motor driving signals in each phase of the coil turns on in a rotation of forward direction
The motor driving signals in each phase of the coil turns on in the figure shown as bellows, and a brushless motor rotates in forward direction.

· Timing Chart of the Motor Driving signals in rotation of forward direction

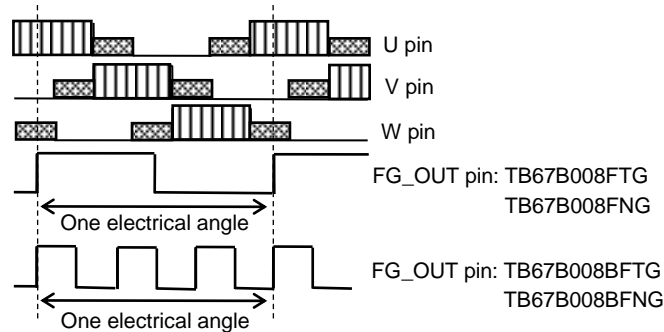

2)Rotation speed detection signal output pin: FG_OUT pin

In case of the TB67B008FTG/TB67B008FNG, the signal of 1 ppr (1 pulse/electrical angle) is outputted according to the motor induced voltage.

Note: In case of 4-polar motor, 2 pulses are outputted per 1 motor rotation.

In case of the TB67B008BFTG/TB67B008BFNG, the signal of 3 ppr (3 pulse/electrical angle) is outputted according to the motor induced voltage.

Note: In case of 4-polar motor, 6 pulses are outputted per 1 motor rotation.

2. Startup Operation

At startup, no induced voltage is generated due to the stationary motor, and the rotor position cannot be detected for sensorless drive.

Therefore, first, this IC fixes a rotor position of motor in DC excitation mode for an appropriate period of time. And then it has a motor make starting up in forced commutation mode.

The DC excitation time is determined by the TIP pin.

The forced commutation frequency is determined by the FST pin.

The output PWM duty cycles in DC excitation and forced commutation modes are determined by the voltage of VST pin.

For sensorless drive mode, the output PWM duty cycle is determined by the speed command input to TSP pin to start and stop the motor operation, and to control the motor speed.

Since the time and startup torques (output PWM duty cycle) in DC excitation and forced commutation vary depending on the motor type and load, they should be adjusted experimentally.

1)DC Excitation Mode

The DC excitation time is determined by the value of capacitor (C_2) connected to the TIP pin.

$$\text{DC excitation time: } T_{ip} = 0.313 \times 31.5 \text{ times} \times C_2 \times 10^6$$

$$\text{When } C_2 = 0.01 \mu\text{F, } T_{ip} = 0.0986 \text{ s}$$

2)Forced Commutation Mode

The forced commutation frequency is determined by the level of the FST pin.

FST = High: Forced commutation frequency $f_{ST} \approx 6.4 \text{ Hz}$

FST = Middle or Open: Forced commutation frequency $f_{ST} \approx 3.2 \text{ Hz}$

FST = Low: Forced commutation frequency $f_{ST} \approx 1.6 \text{ Hz}$

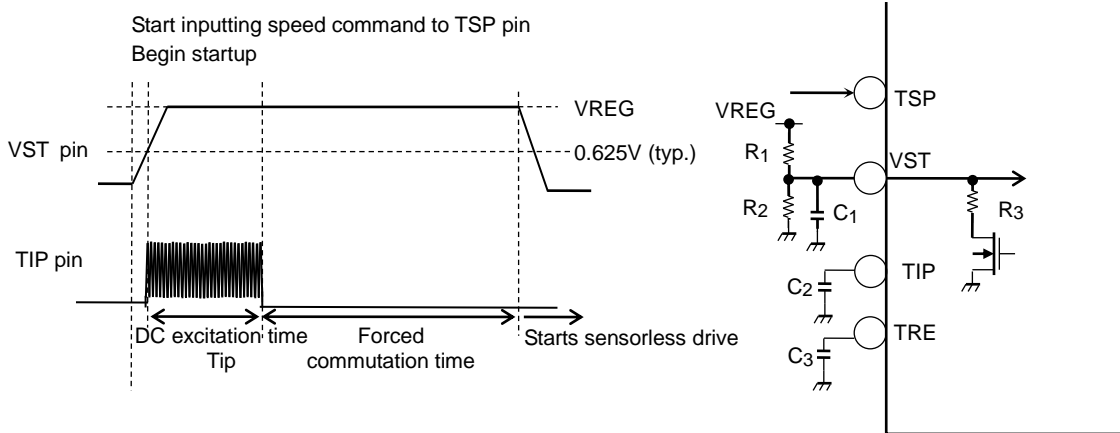

3) Timing Diagram of the Startup Operation

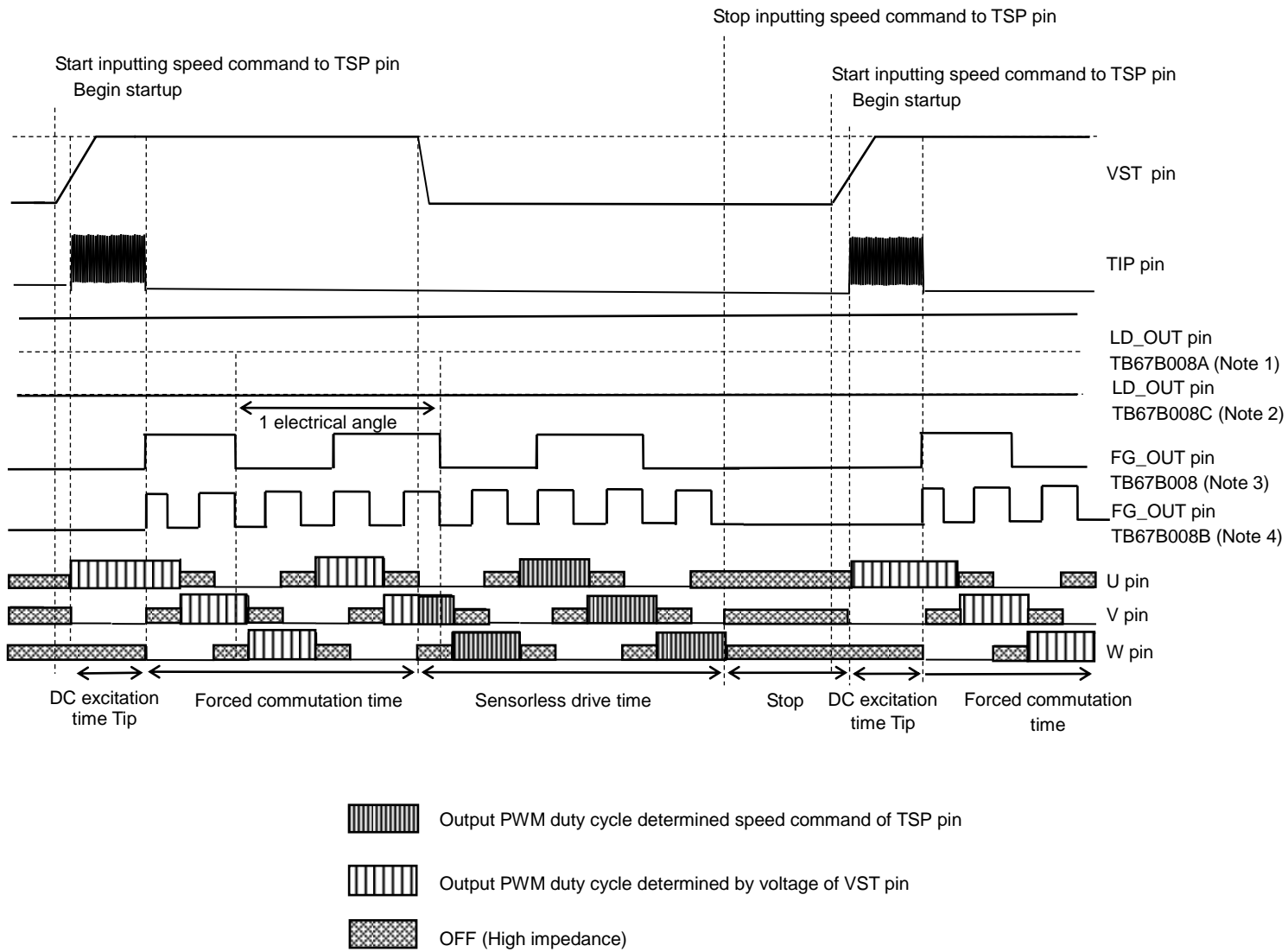

Note 1: TB67B008A means the TB67B008AFTG and the TB67B008AFNG.

Note 2: TB67B008C means the TB67B008CFTG and the TB67B008CFNG.

Note 3: TB67B008 means the TB67B008FTG and the TB67B008FNG.

Note 4: TB67B008B means the TB67B008BFTG and the TB67B008BFNG.

3. Operation in Abnormality Detection

When the following events are detected, the operation in abnormality detection is done.

1. The forced commutation time exceeds four electrical-degree period.
2. The over current detection circuit (ISD) is activated.
3. The thermal shutdown circuit (TSD) is activated.
4. The rotation frequency in sensorless drive mode is the forced commutation frequency or less.
5. The rotation frequency (commutation frequency) is the maximum rotation frequency (FMAX) or more.

FMAX depend on the state of FST pin is shown below.

FST = High: FMAX = 1.5 kHz / 1 electrical angle frequency
 FST = Middle or Open: FMAX = 1.5 kHz / 1 electrical angle frequency
 FST = Low: FMAX = 750 Hz / 1 electrical angle frequency

When any abnormality is detected, output pins are turned off (high impedance) during the operation restart time (Tre). The restart time is determined by the value of a capacitor (C3) connected to TRE pin.

$$\text{Restart time: } T_{re} = 0.313 \times 31.5 \text{ times} \times C_3 \times 10^6$$

When C3 = 1 μF, Tre = 9.86 s

1) Timing chart of abnormality detection

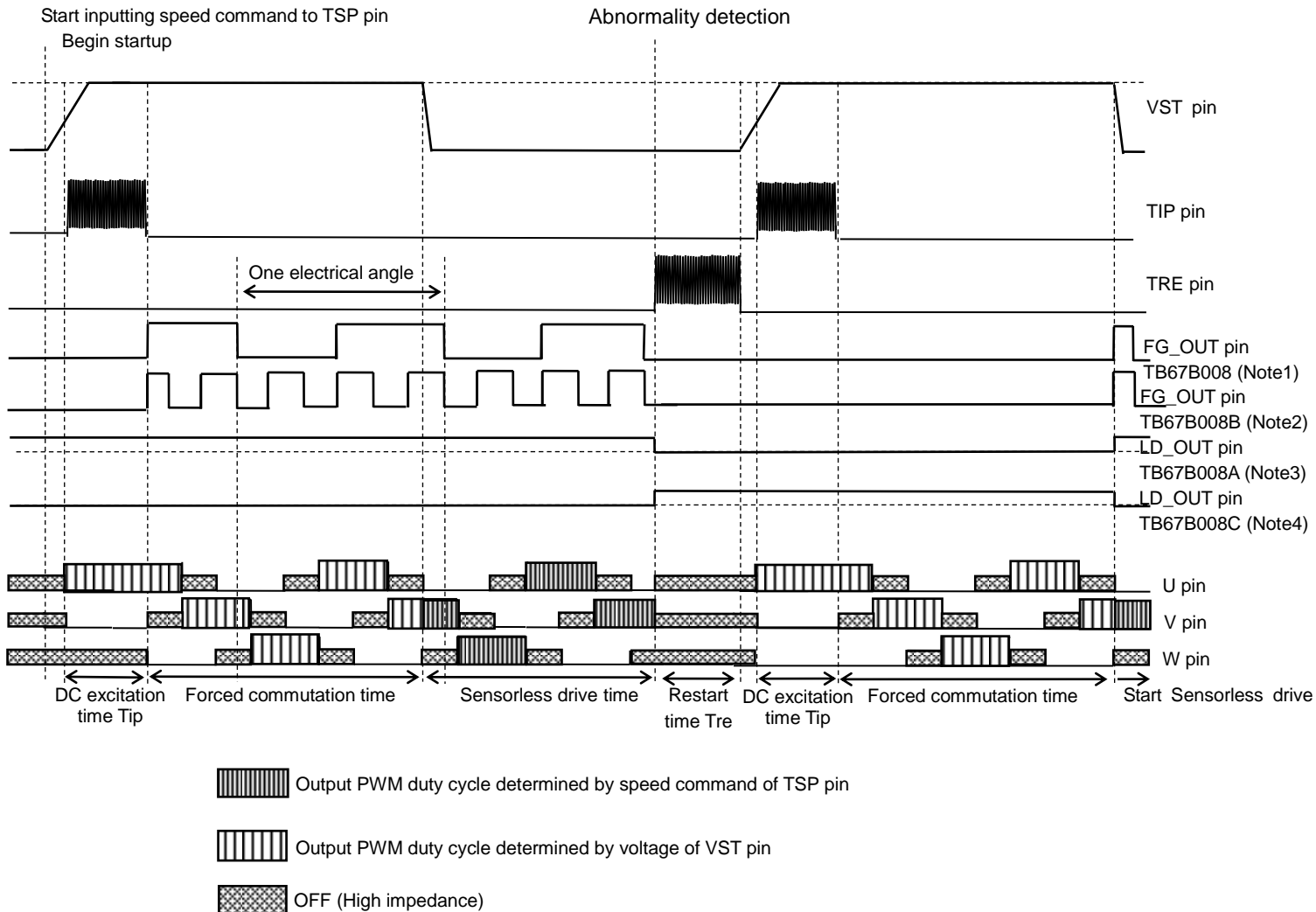

Note 1: TB67B008 means the TB67B008FTG and the TB67B008FNG.
 Note 2: TB67B008B means the TB67B008BFTG and the TB67B008BFNG.
 Note 3: TB67B008A means the TB67B008AFTG and the TB67B008AFNG.
 Note 4: TB67B008C means the TB67B008CFTG and the TB67B008CFNG.

2) Operation in lock detection

When the operation does not move from the forced commutation mode to the senseless drive mode by lock of the motor operation and so on, LD_OUT pin outputs the abnormality detection state from the restart. Then, the following operations are repeated until the sensorless drive mode starts normally.

Restart time → DC excitation time → forced commutation time (4-electrical angles) → Restart time → DC excitation time...

When the inputting speed command to TSP pin is stopped in the lock detection, the LD_OUT pin continues to output the abnormality detection state until the inputting speed command to TSP pin restarts and the mode of operation moves to the sensorless drive.

3) Timing chart of lock detection

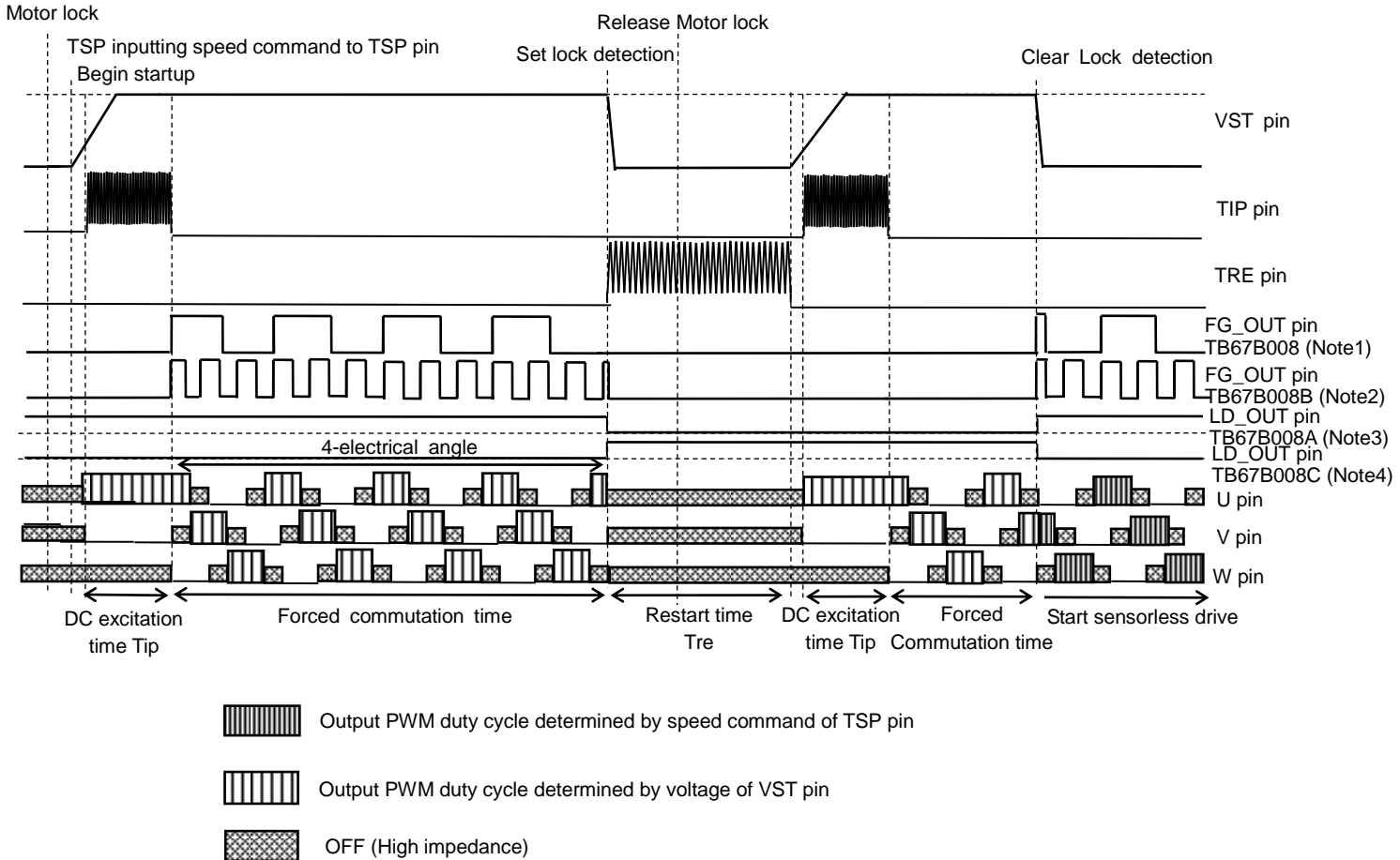

Note 1: TB67B008 means the TB67B008FTG and the TB67B008FNG.

Note 2: TB67B008B means the TB67B008BFNG and the TB67B008BFNG.

Note 3: TB67B008A means the TB67B008AFTG and the TB67B008AFNG.

Note 4: TB67B008C means the TB67B008CFTG and the TB67B008CFNG.

4) Timing chart of stopping speed command of TSP pin during lock detection

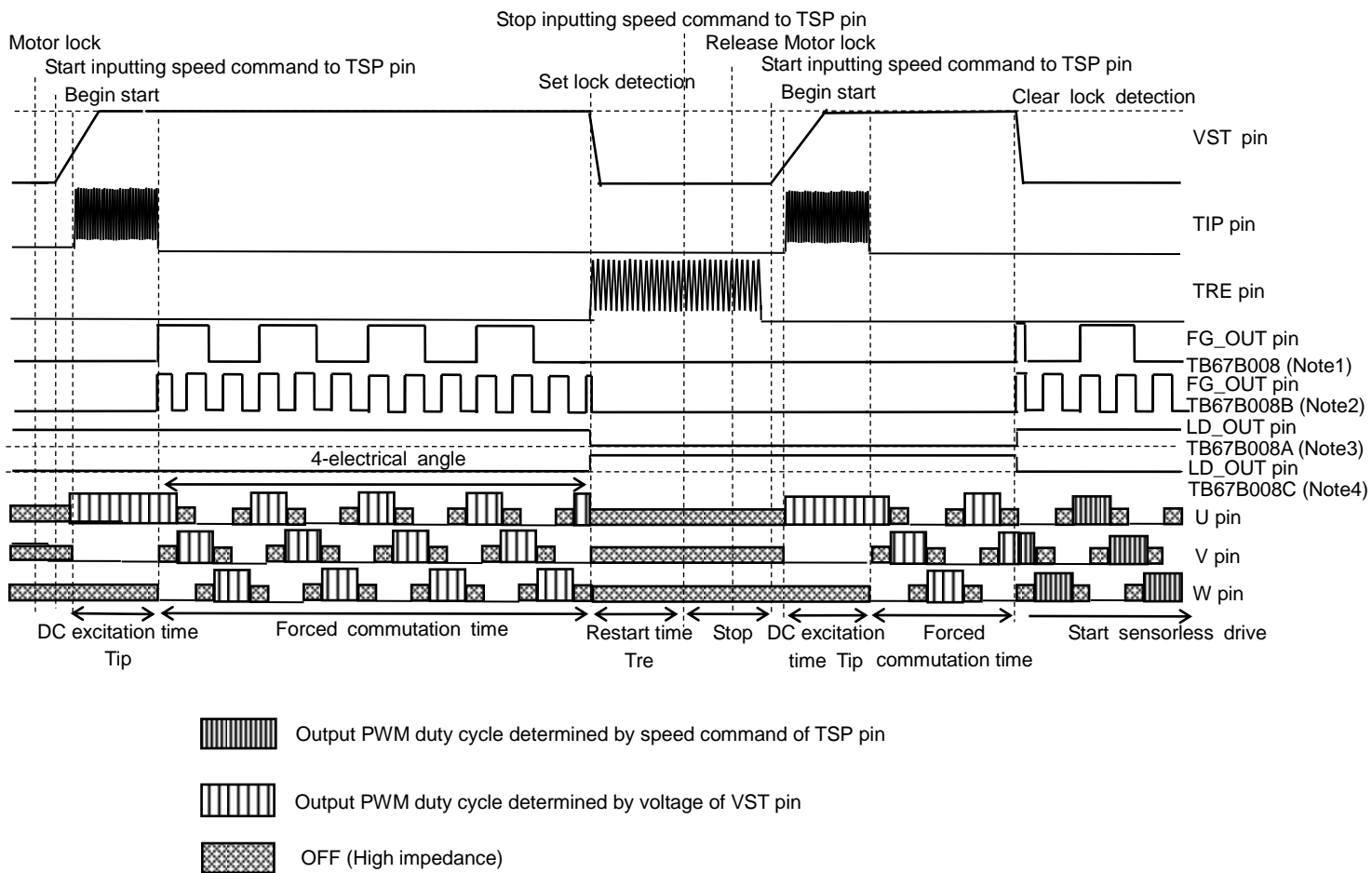

Note 1: TB67B008 means the TB67B008FTG and the TB67B008FNG.

Note 2: TB67B008B means the TB67B008BFNG and the TB67B008BFNG.

Note 3: TB67B008A means the TB67B008AFTG and the TB67B008AFNG.

Note 4: TB67B008C means the TB67B008CFTG and the TB67B008CFNG.

4. PWM Frequency

Output PWM frequency is determined by the input voltage of FPWM pin.

Depending on the set value, the PWM frequency changes according to the rotation speed.

The PWM frequency must be sufficiently high relative to the electrical frequency of the motor and within the range permitted by the switching characteristics of the driver circuit.

Number of setting steps	Input voltage of FPWM pin (V)	Rotation speed (Electrical angle)					
		0 to 200 Hz	200 to 400 Hz	400 to 600 Hz	600 to 800 Hz	800 Hz to 1 kHz	1 to 1.5 kHz
8	2.5	23.8 kHz	47.7 kHz	95.3 kHz	95.3 kHz	190.6 kHz	190.6 kHz
7	2.1875	23.8 kHz	23.8 kHz	47.7 kHz	47.7 kHz	95.3 kHz	95.3 kHz
6	1.875	23.8 kHz	47.7 kHz	95.3 kHz	95.3 kHz	95.3 kHz	95.3 kHz
5	1.5625	47.7 kHz	47.7 kHz	95.3 kHz	95.3 kHz	95.3 kHz	190.6 kHz
4	1.25	47.7 kHz	95.3 kHz	95.3 kHz	95.3 kHz	95.3 kHz	190.6 kHz
3	0.9375	190.6 kHz					
2	0.625	95.3 kHz					
1	0.3125	47.7 kHz					
0	0	23.8 kHz					

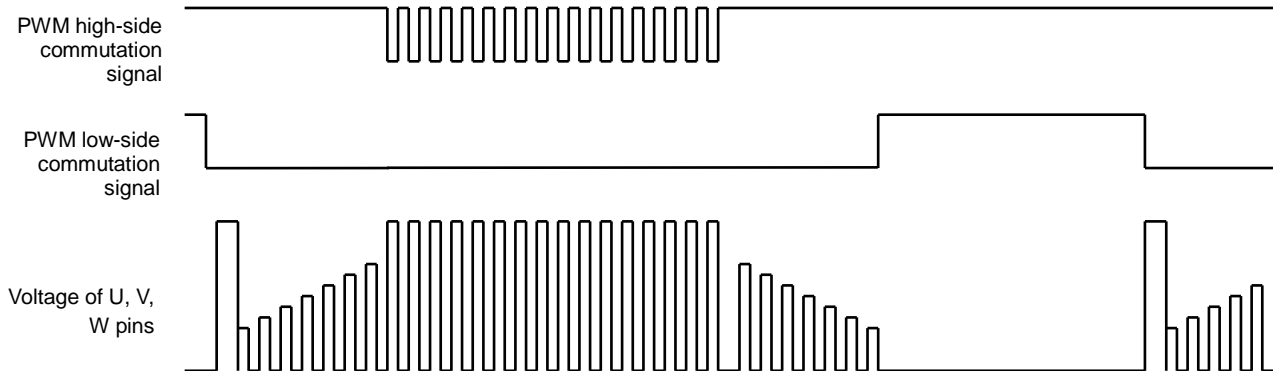
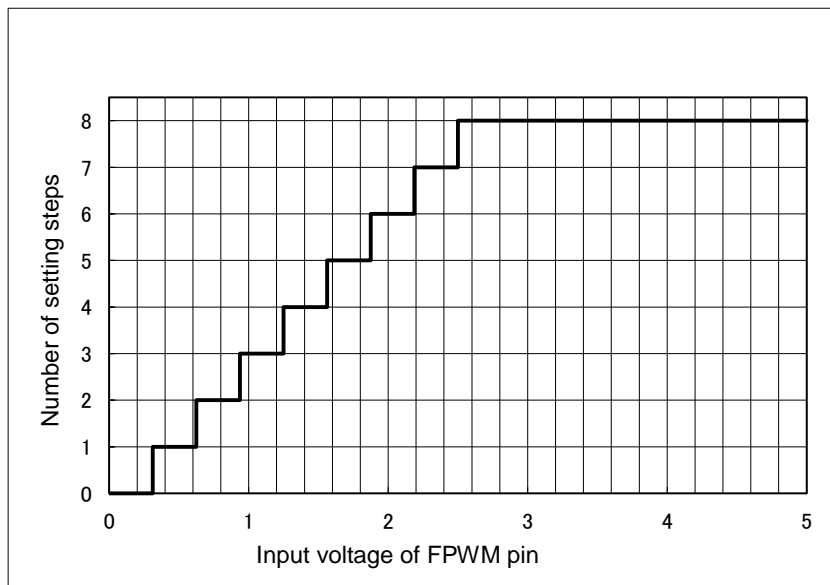

5. Motor Speed Control

Control signal to TSP pin can make on/off the motor and control the output PWM duty cycle to control the rotation speed of the motor.

As other functions, the control signal to TSP pin can adjust the variation of the output PWM duty cycle by the voltage level of ADJ0 pin, ADJ1 pin, and ADJ2 pin.

5.1 Relation between the Voltage of a VST Pin and Output PWM Duty Cycle in DC Excitation and the Forced Commutation Modes.

Output PWM duty cycle in the DC excitation and the forced commutation modes are determined by the voltage of VST pin.

$0 \leq \text{Voltage of VST pin} \leq V_{AD(L)}$: 0.625 V (typ.)

→ Output PWM duty cycle = 0% (0/128)

$V_{AD(L)} \leq \text{Voltage of VST pin} \leq V_{AD(H)}$: 3.125 V (typ.)

→ Output PWM duty cycle = 0% to 100% (0/128 to 128/128)

$V_{AD(H)} \leq \text{Voltage of VST pin} \leq V_{REG}$

→ Output PWM duty cycle = 100% (128/128)

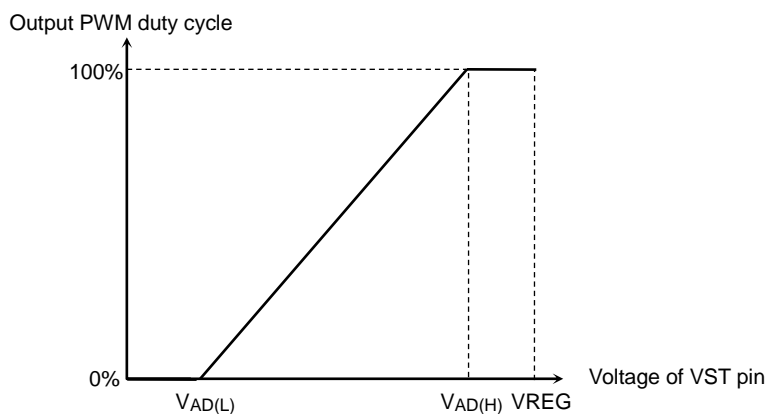

5.2 Relation between PWM Duty Cycle of TSP Pin and Output PWM Duty Cycle in Sensorless Drive Mode

The startup operation begins when the PWM signal is inputted to TSP pin.

The ON time of the PWM signal may not be detected when it is 0.2 μ s or less. Also, the PWM signal is judged as no signal when the OFF time of the PWM signal is 2.5 ms or more.

The frequency of the PWM signal to TSP pin should be in the range from 400 Hz to 100 kHz.

In changing Duty, it should be changed within 510 ms because Duty is kept for 510 ms. When it exceeds 510 ms, the operation is judged stop. When signal of stop is inputted, the operation stops after 510 ms passes because Duty is kept for 510 ms.

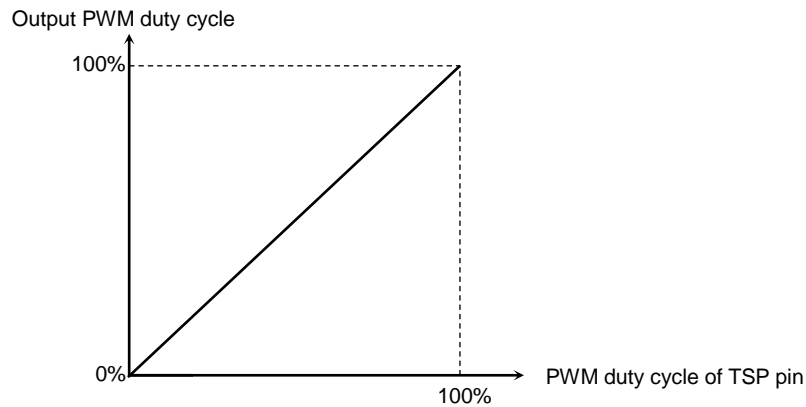

Note: The relation when ADJ1 pin and ADJ2 pin are connect to ground is shown above. For details of ADJ1 pin and ADJ2 pin, refer to 5.3

5.3 Adjustment of the Relation between the Control Signal to TSP Pin and Output PWM Duty Cycle

Two points of output PWM duty cycles can be adjusted by the voltages of ADJ1 pin and ADJ2 pin.

Voltage input pin for adjustment	Adjusted output PWM duty cycle
ADJ1 pin	DOUT1
ADJ2 pin	DOUT2

The DOUT2 is the output PWM duty cycle when the percent value of the control signal of TSP pin is 50% (typ.).

The DOUT1's percent of the control signal can be adjusted by the voltage of ADJ0

Percent value of the control signal of TSP pin	Output PWM duty cycle
Value specified by the voltage of ADJ0 pin (DIN1)	DOUT1
50% (typ.) (DIN2)	DOUT2

- 1) Relation between the voltages of ADJ1 and ADJ2 pins and the output PWM duty cycles (DOUT1, DOUT2)

$0 \leq$ Voltages of ADJ1 and ADJ2 pins $\leq V_{AD(L)}$: 0.625 V (typ.)

→ The output PWM duty cycle (DOUT1, DOUT2) = 0% (0/128)

$V_{AD(L)} \leq$ Voltages of ADJ1 and ADJ2 pins $\leq V_{AD(H)}$: 3.125 V (typ.)

→ The output PWM duty cycle (DOUT1, DOUT2) = 0% to 100% (0/128 to 128/128)

$V_{AD(H)} \leq$ Voltages of ADJ1 and ADJ2 pins $\leq V_{REG}$

→ The output PWM duty cycle (DOUT1, DOUT2) = 100% (128/128)

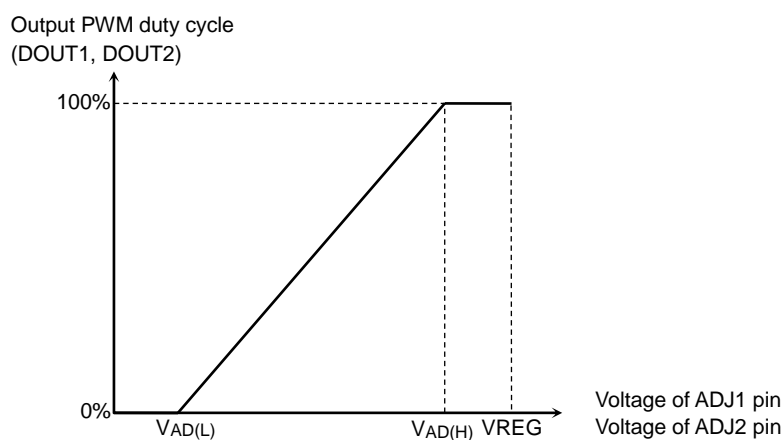

Note: Voltage setting of ADJ1 pin and ADJ2 pin should be set as follows; voltage of ADJ1 pin \leq voltage of ADJ2 pin. If it is set as follows; voltage of ADJ1 pin $>$ voltage of ADJ2 pin, this function may not operate correctly.

- 2) Relation between a voltage of ADJ0 pin and the DIN1 which makes the output PWM duty cycle as the DOUT1 is shown bellows ;

$0 \leq$ Voltages of ADJ0 pin $\leq V_{AD(L)}$: 0.625 V (typ.)
 → The percent of the control signal (DIN1) = 0% (0/128)
 $V_{AD(L)} \leq$ Voltages of ADJ0 pin $\leq V_{AD(H)}$: 3.125 V (typ.)
 → The percent of the control signal (DIN1) = 0% to 50% (0/128 to 128/128)
 $V_{AD(H)} \leq$ Voltages of ADJ0 pin $\leq V_{REG}$
 → The percent of the control signal (DIN1) = 50% (128/128)

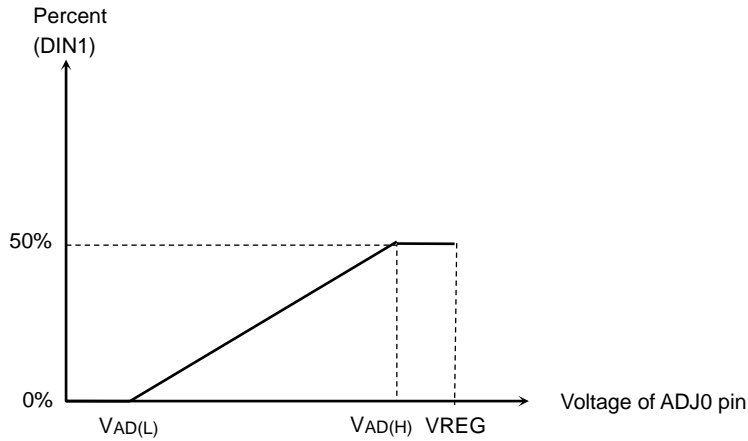

- 3) When the percent value of the control signal is equal or less than the duty cycle (DIN1) specified by a voltage of ADJ0 pin, the relation between the percent value of the control signal and output PWM duty cycle according to the state of SEL_ADJ pin is shown in the below table.

SEL_ADJ	Operation state
High	When the percent value of the control signal is DIN1 or less, the output PWM duty cycle is kept as DOUT1.
Middle	When the percent value of the control signal is DIN1 or less, the output PWM duty cycle changes in linier from the output PWM duty cycle of DIN1 to 0%.
Low	When the percent value of the control signal is DIN1 or less, the output PWM duty cycle is fixed to 0%.

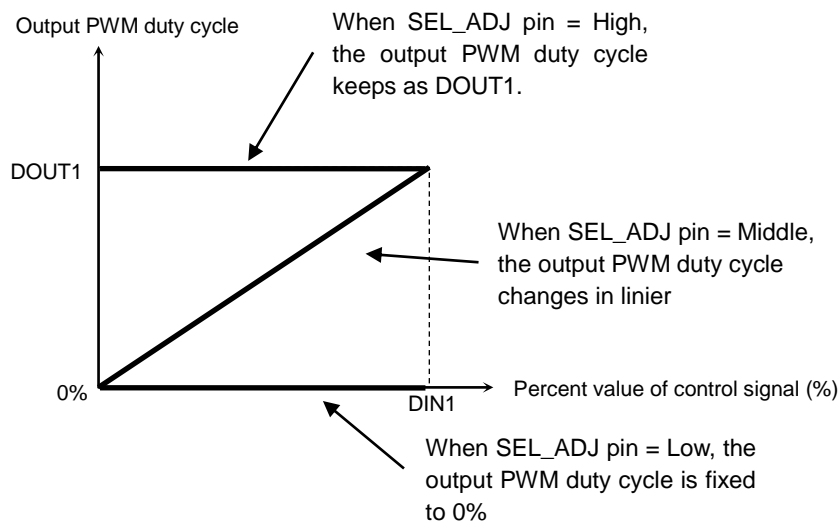

4) Setting example

Percent of control signal of TSP pin	Output PWM duty cycle
Up to 20%	From 0% to 30% in linier
20% (DIN1)	30% (DOUT1)
50% (typ.) (DIN2)	40% (DOUT2)

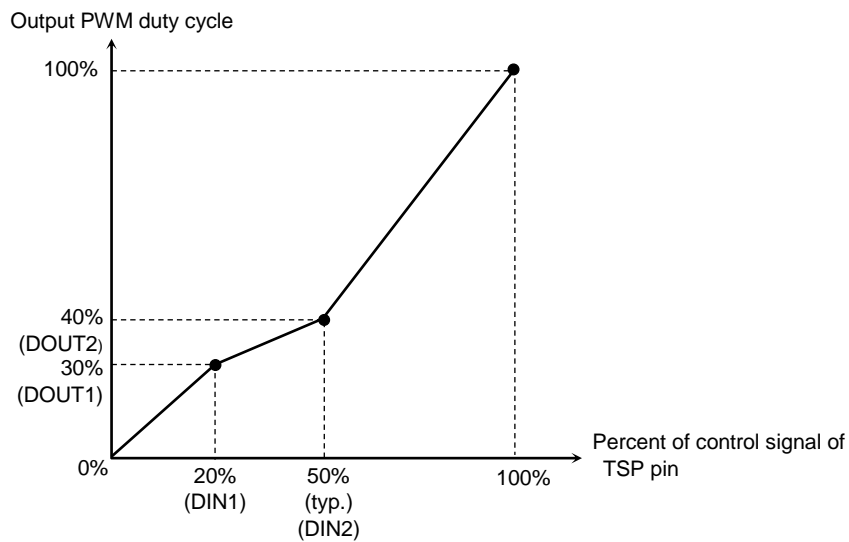

To set the above relation between the percent of control signal of TSP pin and the output PWM duty cycle, set the level of SEL_ADJ pin and the voltage of ADJ0 pin, ADJ1 pin and ADJ2 pin shown below.

- SEL_ADJ pin = MIDDLE
- Voltage of ADJ0 pin: $(20\% / 50\% \times (3.125 - 0.65V)) + 0.625V = 1.625V$
- Voltage of ADJ1 pin: $(30\% / 100\% \times (3.125 - 0.65V)) + 0.625V = 1.375V$
- Voltage of ADJ2 pin: $(40\% / 100\% \times (3.125 - 0.65V)) + 0.625V = 1.625V$

6. Commutation Control Description

In forced commutation mode at startup, this IC is configured for 120° commutation with a lead angle of 0°, and without soft switching.

Then, when the operation mode enters sensorless driving mode, its commutation waveform automatically changes to the one specified by the LA pin.

The lead angle depending on the rotation speed is determined by the voltage via LA pin.

When FST pin = Low, the lead angle changes whenever the rotation speed increases 100 Hz. When FST pin = Middle or open, and High, the lead angle changes whenever it increases 200 Hz.

Soft switching function is that the output PWM duty in output commutation switching changes in stages.

1) Setting lead angle

Number of setting steps	Input voltage of LA pin (V)	Rotation speed (electrical angle)					
		In FST pin = Low, upper (0 to 750 Hz) / In FST pin = High or Middle, lower (0 to 1.5 kHz)					
		0 Hz to less than 100 Hz	100 Hz to less than 200 Hz	200 Hz to less than 300 Hz	300 Hz to less than 400 Hz	400 Hz to less than 500 Hz	500 Hz to 750 Hz
		0 Hz to less than 200 Hz	200 Hz to less than 400 Hz	400 Hz to less than 600 Hz	600 Hz to less than 800 Hz	800 Hz to less than 1 kHz	1 kHz to 1.5 kHz
8	2.5	11.25°	15°	15°	15°	15°	15°
7	2.1875	7.5°	11.25°	15°	15°	15°	15°
6	1.875	3.75°	7.5°	11.25°	15°	15°	15°
5	1.5625	0°	3.75°	7.5°	11.25°	15°	15°
4	1.25	7.5°	15°	15°	15°	15°	15°
3	0.9375	0°	7.5°	15°	15°	15°	15°
2	0.625	15°					
1	0.3125	7.5°					
0	0	0°					

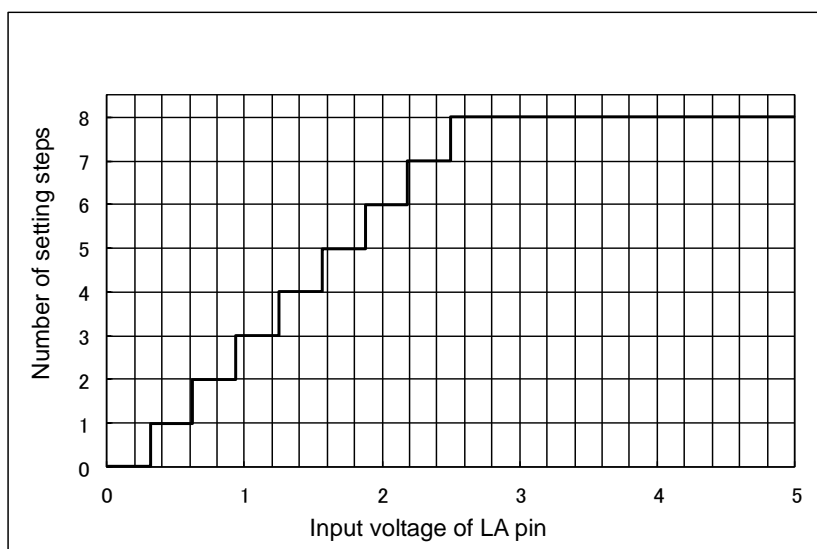

2) Waveform of commutation timing

Example for 150° commutation with a lead angle of 0°

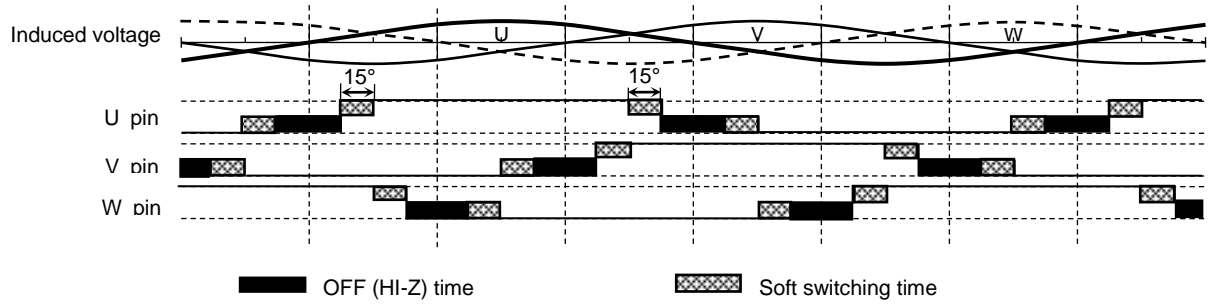

7. Current Limiter Circuit

The current limiter circuit limits the current by turning the high-side transistors off. These transistors are turned back on again when the PWM signal is turned on.

The output current is monitored as a voltage across R_1 by a comparator. If it exceeds the rated VRS voltage (0.25 V typ.), the current limiter is activated.

A masking time of current limit detection (TRS) of 3 μs (typ.) is provided to avoid an incorrect operation by an external noise, etc.

Example: When $R_1 = 0.3 \Omega$, the current I_{OUT} which activates the current limiter circuit is shown as below;
 $I_{OUT} = 0.25 \text{ V (typ.)} / 0.3 \Omega \approx 0.83 \text{ A}$

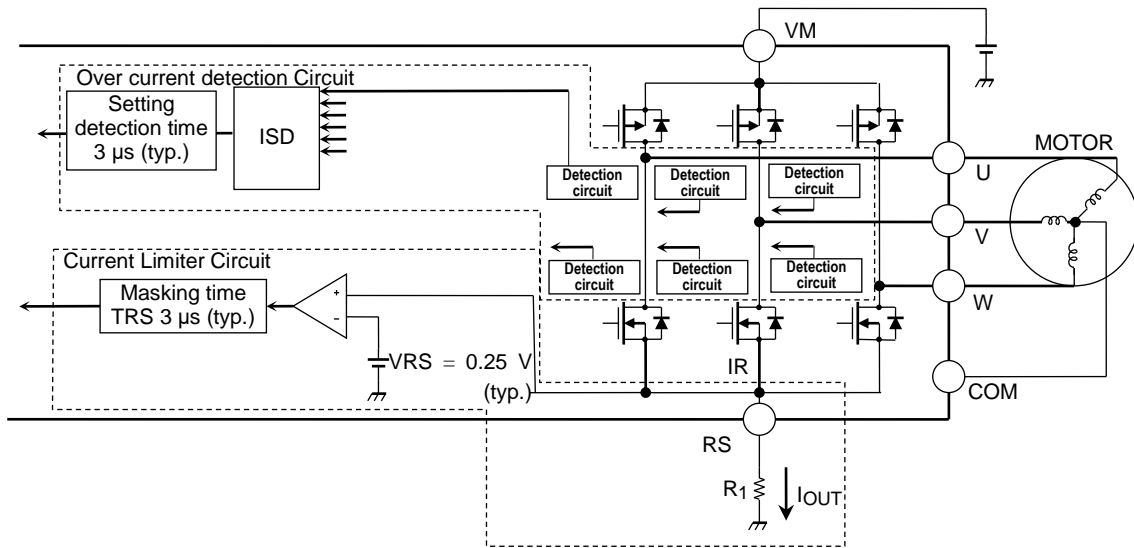

<Current Limiter Circuit Operation>

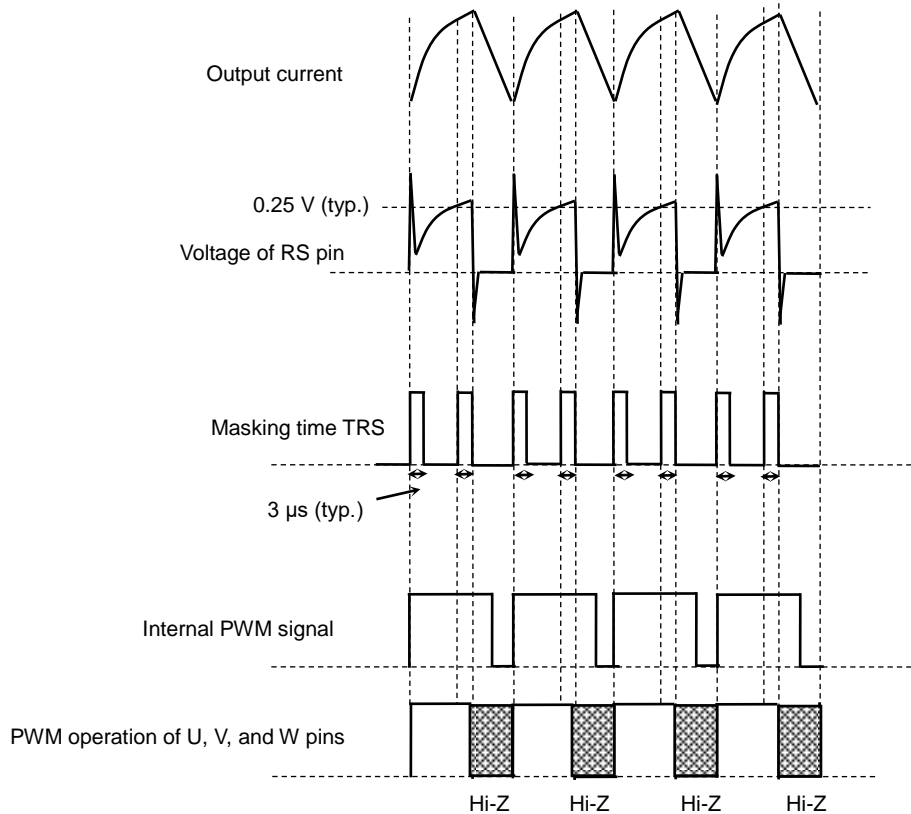

8. Over Current Detection Circuit (ISD)

This IC incorporates the detection circuit for each six output transistors that monitors the current flowing. The six outputs of detection circuits are inputted to over current detection circuit (ISD). The threshold current of over current detection circuit is from 3 A to 6 A.

And if the current at any one of six transistors is the equal or more than the threshold current for 3 μs (Masking time of over current detection circuit: TISD) (typ.) or longer, ISD makes all output transistors turning off (high impedance).

If the current at all transistors is less than the threshold current, this IC begins normal operation after the restart time (Tre) that is specified by the value of a capacitor(C3) connected to TRE pin has elapsed.

Example: Restart time: $T_{re} (s) = 0.313 \times 31.5 \text{ times} \times C_3 (F) \times 10^6$

When $C_3 = 1 \mu F$, $T_{re} = 9.86 \text{ s}$.

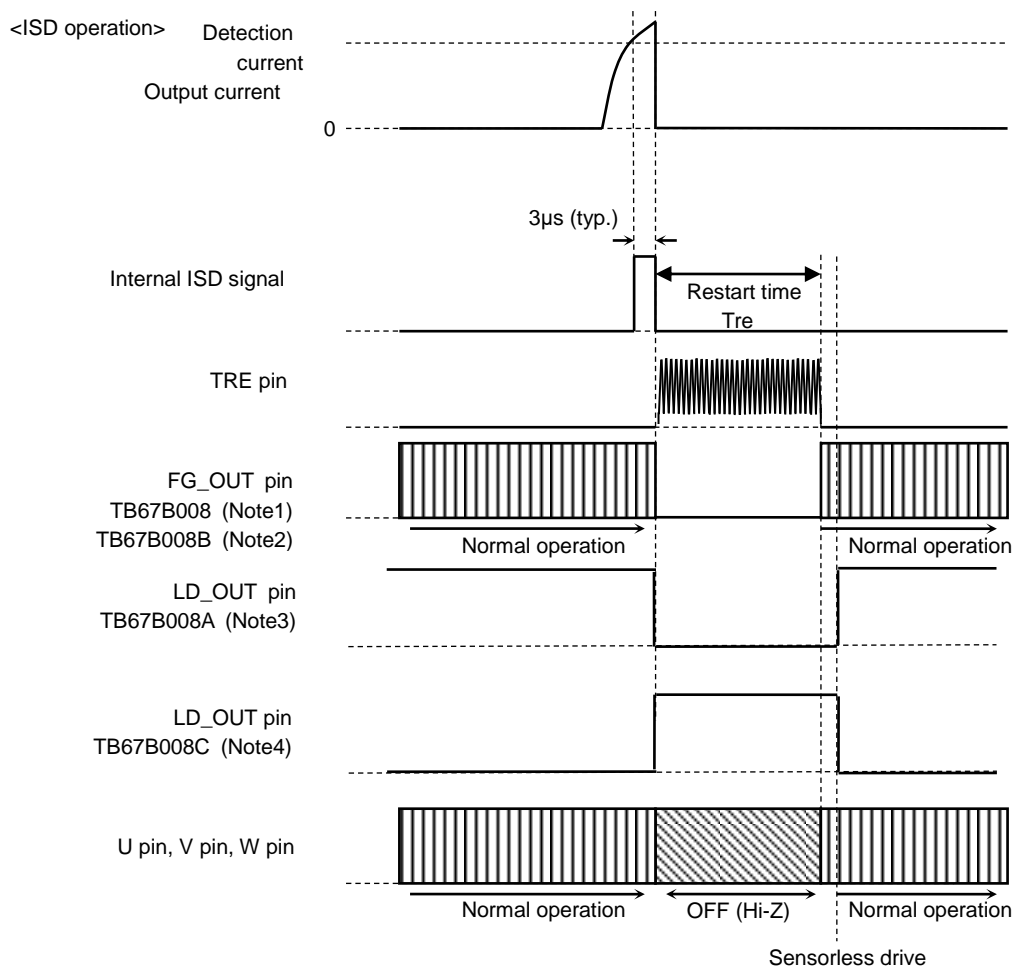

Note: When the ISD circuit is activated, the output current is more than the absolute maximum current rating. This circuit is provided as an auxiliary only and does not necessarily provide the IC with a perfect protection from damages due to over current caused by power fault, ground fault, load-short and the like.

Note 1: TB67B008 means the TB67B008FTG and the TB67B008FNG.

Note 2: TB67B008B means the TB67B008BFTG and the TB67B008BFNG.

Note 3: TB67B008A means the TB67B008AFTG and the TB67B008AFNG.

Note 4: TB67B008C means the TB67B008CFTG and the TB67B008CFNG.

9. PWM Duty Cycle Increasing Time Control Circuit

When input duty cycle of the signal to TSP pin is increasing, it reflects output duty cycle. By the PWM duty increasing time control circuit, the output PWM duty cycle can be gradually increased in a startup operation.

The PWM duty cycle increasing time is specified by a value of a capacitor (C) connected to TSTEP pin

Example: PWM duty cycle increasing time: $T_{soft} (S) = 0.313 \times 31.5 \text{ times} \times C \times 10^6$

When $C = 0.01 \mu\text{F}$, $T_{soft} = 0.0986 \text{ s}$.

When pulse duty of input signal is increased by 13%.

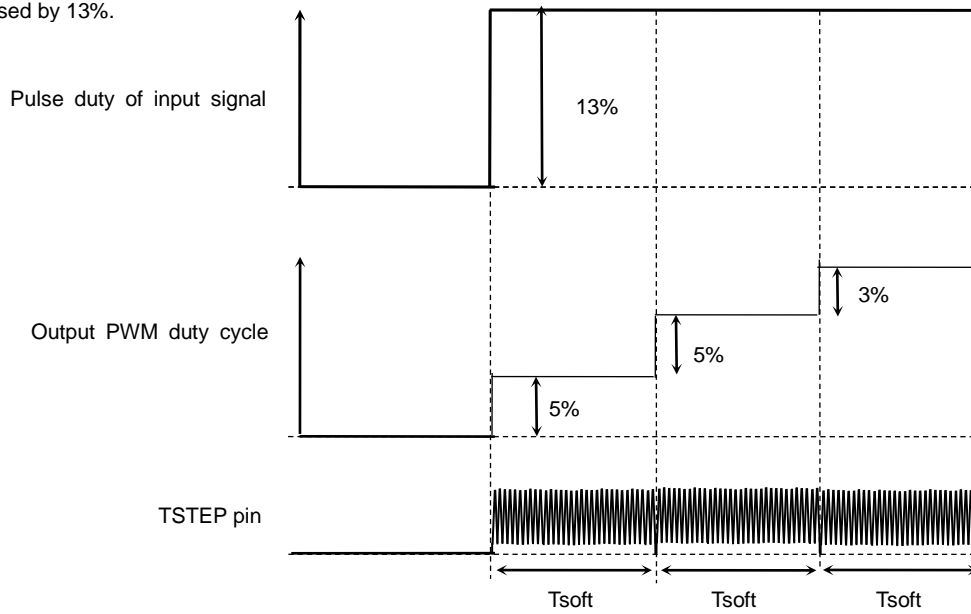

10. Thermal Shutdown Circuit (TSD)

This IC has the thermal shutdown circuit (TSD). When the junction temperature (T_j) exceeds 165°C (typ.), a thermal shutdown circuit makes all output transistors turning off (high impedance: Hi-Z). The hysteresis width of a threshold temperature of thermal shutdown circuit is 15°C (typ.).

When the junction temperature is lowered less than 150°C (typ.), this IC begins normal operation after the restart time (T_{re}) that is specified by the value of a capacitor (C_3) connected to TRE pin has elapsed.

$$\text{Restart time: } T \text{ (s)} = 0.313 \times 31.5 \text{ times} \times C_3 \text{ (F)} \times 10^6$$

$$\text{When } C_3 = 1 \mu\text{F}, T = 9.86 \text{ s.}$$

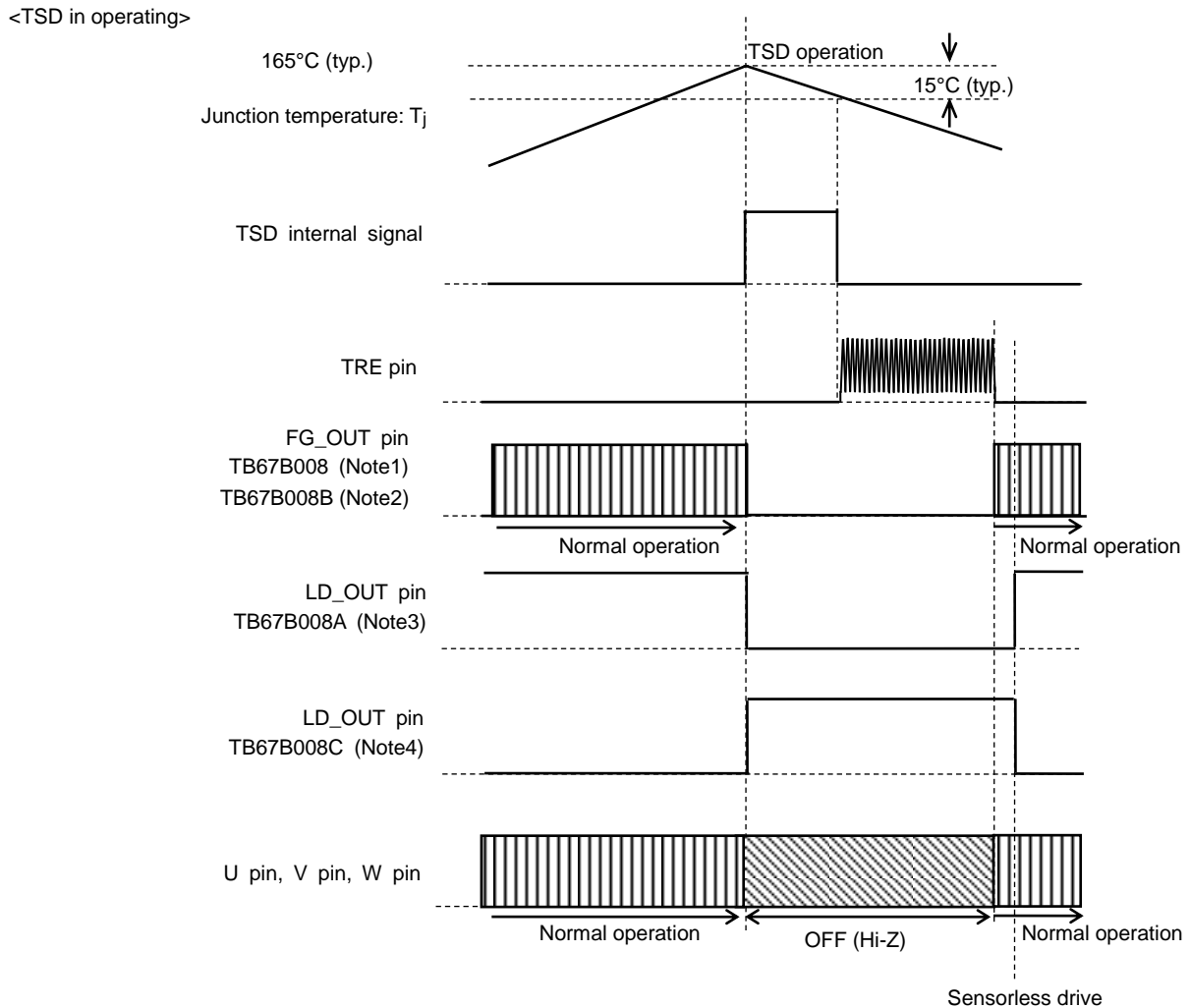

Note: The TSD circuit is activated if the absolute maximum junction temperature rating (T_j) of 150°C is violated. Note that the circuit is provided as an auxiliary only and does not necessarily provide the IC with a perfect protection from any kind of damages.

Note 1: TB67B008 means the TB67B008FTG and the TB67B008FNG.

Note 2: TB67B008B means the TB67B008BFTG and the TB67B008BFNG.

Note 3: TB67B008A means the TB67B008AFTG and the TB67B008AFNG.

Note 4: TB67B008C means the TB67B008CFTG and the TB67B008CFNG.

11. Under Voltage Lock Circuit (UVLO)

This IC includes an under voltage lockout circuit.

It resets the internal logic and makes all output transistors turning off (high-impedance: Hi-Z) when VM decreases to 3.4 V (typ.) or less. The hysteresis width of under voltage lockout is 0.3 V (typ.). The releasing voltage is 3.7 V (typ.).

This IC resets the internal logic and makes all output transistors turning off (high-impedance: Hi-Z) when VREG decreases to 3.0 V (typ.) or less. The hysteresis width of under voltage lockout is 0.2 V (typ.). The releasing voltage is 3.2 V (typ.).

Note: Wait time for returning the startup operation depends on the state of the motor; stopping and the rotation number in futile state, etc. It is approximately from 0.02 s to 0.34 s.

<VM voltage UVLO operation>

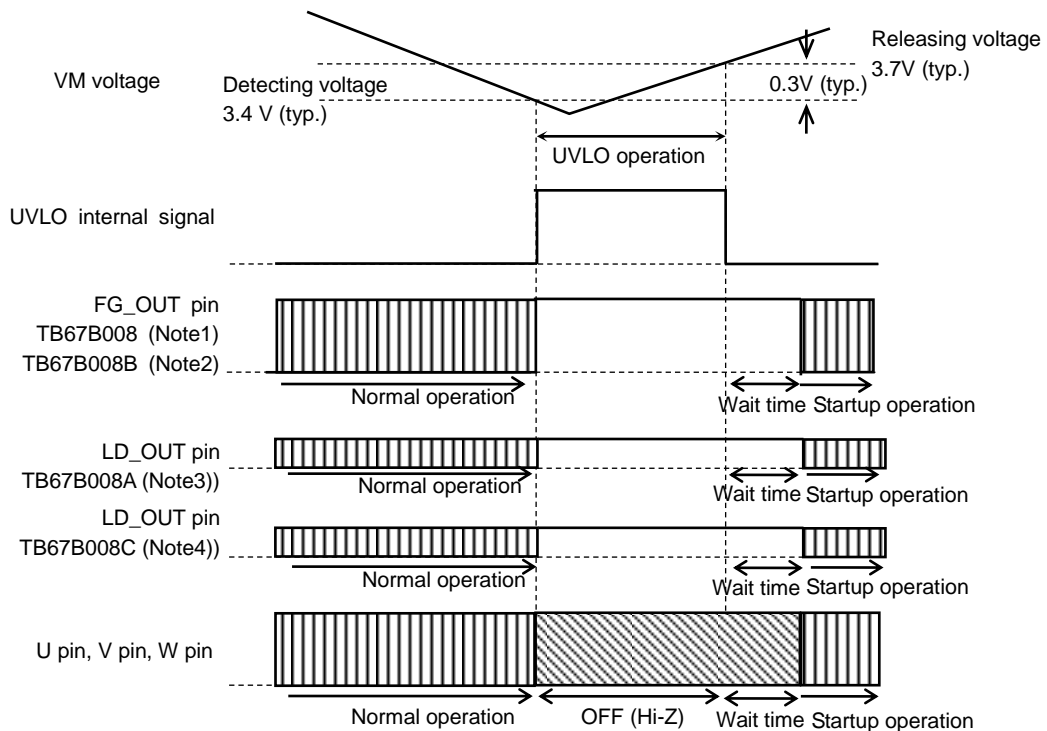

Note 1: TB67B008 means the TB67B008FTG and the TB67B008FNG.

Note 2: TB67B008B means the TB67B008BFNG and the TB67B008BFNG.

Note 3: TB67B008A means the TB67B008AFTG and the TB67B008AFNG.

Note 4: TB67B008C means the TB67B008CFTG and the TB67B008CFNG.

<VREG voltage UVLO operation>

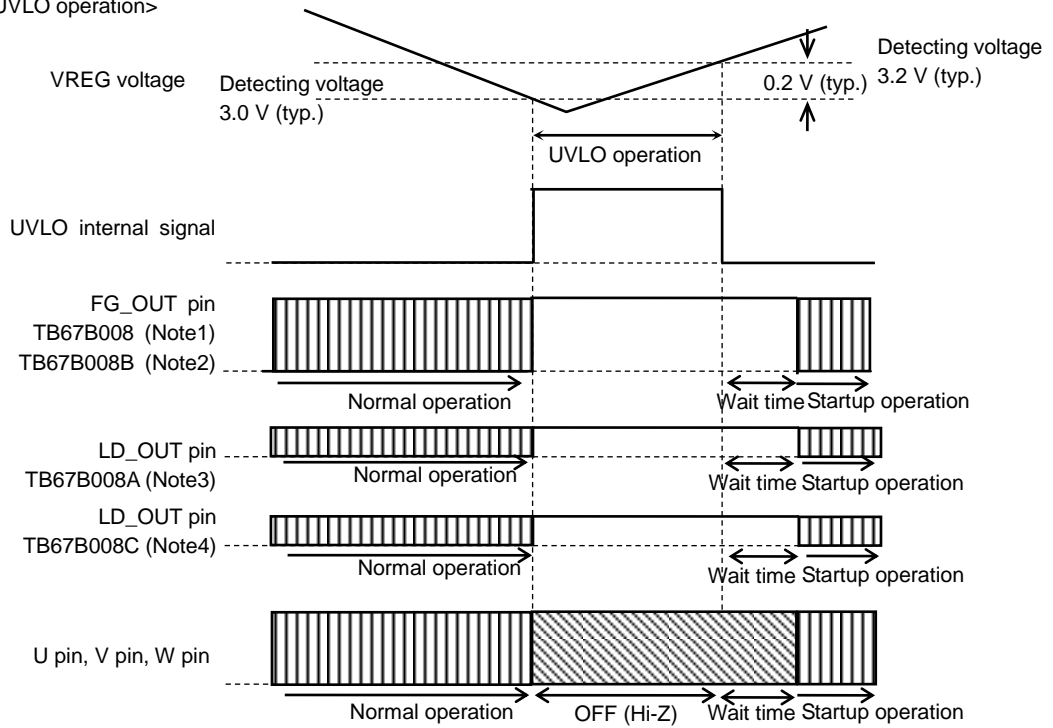

Note 1: TB67B008 means the TB67B008FTG and the TB67B008FNG.

Note 2: TB67B008B means the TB67B008BFNG and the TB67B008BFNG.

Note 3: TB67B008A means the TB67B008AFTG and the TB67B008AFNG.

Note 4: TB67B008C means the TB67B008CFTG and the TB67B008CFNG.

I/O Equivalent Circuits

The equivalent circuit diagrams may be simplified or some parts of them may be omitted for explanatory purposes.

Pin Name	I/O Signal	I/O Internal Circuit
FST SEL_ADJ	Forced commutation frequency select input pin Output PWM duty cycle function setting pin	
ADJ0 ADJ1 ADJ2 LA FPWM	Adjusting pin for characteristics of speed command input Adjusting pin 1 for characteristics of output PWM duty cycle Adjusting pin 2 for characteristics of output PWM duty cycle Lead angle setting input pin Output PWM frequency select input pin	
VST	Output PWM duty cycle setting pin in DC excitation and forced commutation modes	
TSP	Speed command input pin (PWM duty cycle control in sensorless drive mode)	

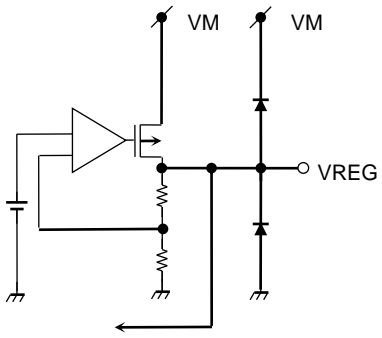
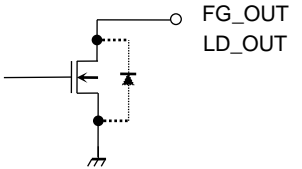
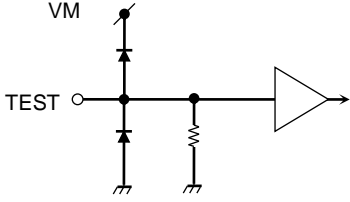
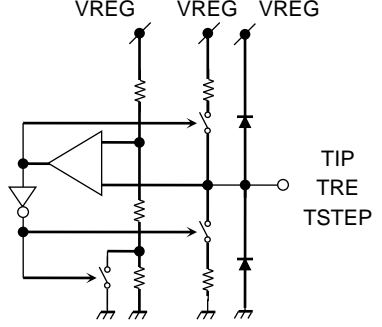
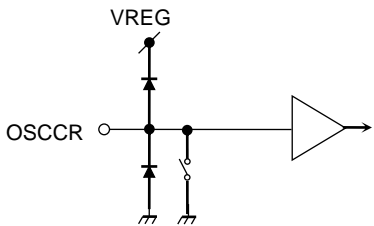
Pin Name	I/O Signal	I/O Internal Circuit
VREG	Reference voltage output	
FG_OUT LD_OUT	Rotation speed detection signal output pin (open-drain) Lock detecting signal output pin (open-drain) An externally attached pull-up resistor enables the High output.	
TEST	Test pin Connect to ground.	
TIP TRE TSTEP	Connection pin for a capacitor to set the DC excitation time Connection pin for a capacitor to set the restart time Pin for the Output PWM duty cycle function	
OSCCR	Internal OSC setting pin	

Pin Name	I/O Signal	I/O Internal Circuit
<p>U</p> <p>V</p> <p>W</p> <p>VM</p> <p>COM</p> <p>RS</p>	<p>U-phase output</p> <p>V-phase output</p> <p>W-phase output</p> <p>Motor power supply pin</p> <p>Connection pin for the center tap of the motor pin</p> <p>Connection pin for output current detecting resistor pin</p>	

Absolute Maximum Ratings (Note) (Ta = 25 °C)

Characteristics	Symbol	Rating	Unit
Power supply voltage	VM	25	V
Input voltage	V _{IN1} (Note1)	-0.3 to 6.0	V
	V _{IN2} (Note2)	-0.3 to 25	V
	V _{IN3} (Note3)	-0.3 to V _{REG} +0.3	V
Output voltage	V _{OUT1} (Note4)	25	V
	V _{OUT2} (Note5)	25	V
Output current	I _{OUT1} (Note6)	3 (Note9)	A
	I _{OUT2} (Note7)	10	mA
	I _{OUT3} (Note8)	5	mA
Power dissipation	P _{D1}	3.37 (Note10)	W
	P _{D2}	2.2 (Note11)	W
Operating temperature	T _{opr}	-40 to 105	°C
Storage temperature	T _{stg}	-55 to 150	°C

Note: The absolute maximum ratings of a semiconductor device are a set of ratings that must not be exceeded, even for a moment. Do not exceed any of these ratings.

Exceeding the rating (s) may cause the device breakdown, damage or deterioration, and may result injury by explosion or combustion.

Please use this IC within the specified operating ranges.

Note1: V_{IN1} is applicable to the voltage at the following pins:

TSP pin

Note2: V_{IN2} is applicable to the voltage at the following pin:

COM pin.

Note3: V_{IN3} is applicable to the voltage at the following pins.

SEL_SP pin, ADJ0 pin, ADJ1 pin, ADJ2 pin, OSCCR pin,
VST pin, FPWM pin, LA pin, SEL_ADJ pin, FST pin, TSTEP pin, TIP pin, and TRE pin

Note4: V_{OUT1} is applicable to the voltage at the following pins:

U pin, V pin, and W pin

Note5: V_{OUT2} is applicable to the voltage at the following pins:

FG_OUT/LD_OUT pin

Note6: I_{OUT1} is the current from the following pins:

U pin, V pin, and W pin

Note7: I_{OUT2} is the current from the following pins:

FG_OUT/LD_OUT pin

Note8: I_{OUT3} is the current from the following pin:

VREG pin.

Note9: Output current may be limited by the ambient temperature or the device implementation. The maximum junction temperature should not exceed 150°C

Note10: WQFN24: When mounted on the board (4 layers: FR4: 74 mm x 74 mm x 1.6 mm)

Note11: SSOP24: When mounted on the board (JEDEC-compatible 4 layers: FR4: 76.2 mm x 114.3 mm x 1.6 mm)

Operating Ranges

Characteristics	Symbol	Min	Typ.	Max	Unit
Power supply voltage 1	VM _{opr1}	5.5	12	22	V
Power supply voltage 2 (Note1)	VM _{opr2}	4	5	5.5	V
Input frequency of TSP pin	foprTSP	0.4	25	100	kHz

Note 1: When voltage of VM is 5.5 V or less, the characteristics of the ON-resistance of output transistor and VREG output voltage change.

Package Power Dissipation (Reference data)

· WQFN24

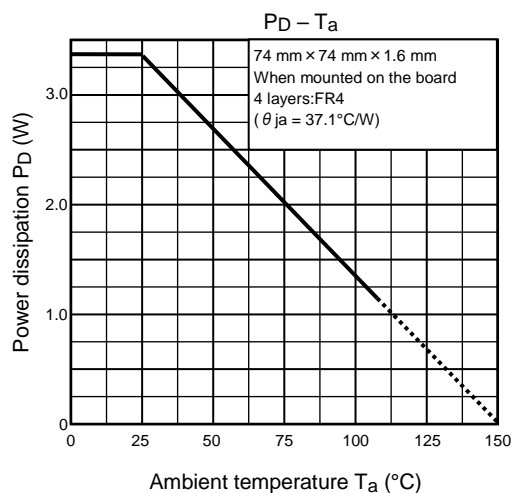

· SSOP24

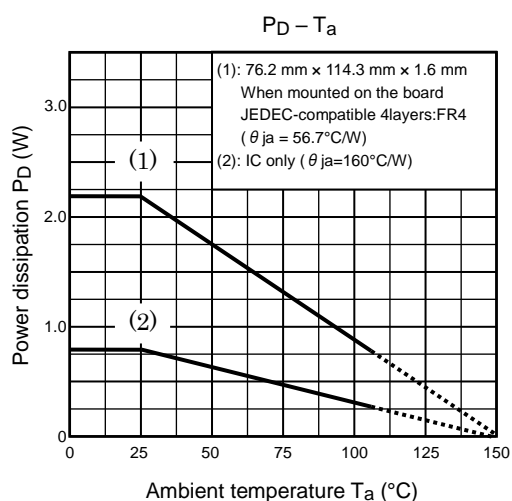

Electrical Characteristics (Ta = 25°C, VM = 12 V, unless otherwise specified)

Characteristics	Symbol	Test Conditions	Min	Typ.	Max	Unit
Static power supply current at VM	IM	When TSP pin = 0 V	—	5.5	8	mA
Dynamic power supply current at VM	IM(opr)	When TSP pin = VREG, RS pin = TIP pin = COM pin = 0 V	—	6	8.5	mA
Input current	IIN1(H)	When VIN = 5 V FST, SEL_ADJ pins	—	100	150	μA
	IIN1(L)	When VIN = 0 V, FST, SEL_ADJ pins	-150	-100	—	
	IIN2D(H)	When VIN = VREG, TSP pin	—	100	150	
	IIN2D(L)	When VIN = 0 V, TSP pin	-1	—	1	
	IIN3	When VIN = 0 V to VREG ADJ0, ADJ1, ADJ2, VST, LA, FPWM pins	-1	—	1	
Input voltage	VIN1(H)	TSP pin	2.0	—	—	V
	VIN1(L)		0	—	0.8	
	VIN2(H)	FST, SEL_ADJ pins	VREG × 0.8	—	VREG + 0.3	
	VIN2(M)		VREG × 0.4	—	VREG × 0.6	
VIN2(L)	0		—	VREG × 0.2		
Input voltage hysteresis	V1hys	TSP pin (Reference data)	—	0.12	—	V
Output PWM duty cycle increasing time	Tsoft	When a value of the capacitor connected to TSTEP pin = 0.01 μF (Reference data)	—	0.0986	—	s
DC excitation time	Tip	When a value of the capacitor connected to TIP pin = 0.1 μF (Reference data)	—	0.986	—	s
Restart time	Tre	When a value of the capacitor connected to TRE pin = 1 μF (Reference data)	—	9.86	—	s
High-level output voltage at TIP, TRE, and TSTEP pins	VH	—	2.25	2.5	2.75	V
Low-level output voltage at TIP, TRE, and TSTEP pins	VL	—	0.45	0.5	0.55	V
COM pin input current	ICOM	—	-5	-1.3	1	μA
Position detection comparator offset voltage	Voffset	(Reference data)	-10	0	10	mV
Low-level output voltage at FG_OUT/LD_OUT pins	V_LFG_OUT	When IOUT = 5 mA	0	—	0.5	V
Leakage current at FG_OUT/LD_OUT pins	I_LFG_OUT	When VOUT = 25 V	—	0	2	μA
ON-resistance of Output transistor at the U, V and W pins	RON1(H)	When IOUT = -0.1 A	—	0.3	0.6	Ω
	RON1(L)	When IOUT = 0.1 A	—	0.3	0.6	
	RON2(H)	When IOUT = -0.1 A, VM = 4.0 V	—	0.33	0.6	
	RON2(L)	When IOUT = 0.1 A, VM = 4.0 V	—	0.33	0.6	
Output leakage current at the U, V and W pins	IL(H)	When VOUT = 0 V	-10	0	—	μA
	IL(L)	When VOUT = 25 V	—	0	10	
Output diodes' forward voltage at the U, V and W pins	VF(H)	When IOUT = 1.5 A (Reference data)	—	1.0	1.4	V
	VF(L)	When IOUT = -1.5 A (Reference data)	—	1.0	1.4	
VST ON resistance in power on	RVST	—	—	600	1000	Ω
Masking time of current limit detection	TRS	(Reference data)	—	3	—	μs
Voltage of RS pin for current limit detection	VRS	—	0.225	0.25	0.275	V

Characteristics	Symbol	Test Conditions	Min	Typ.	Max	Unit
PWM oscillation frequency	FPWM4	(Reference data)	171.5	190.6	209.7	kHz
	FPWM3	(Reference data)	85.7	95.3	104.9	
	FPWM2	(Reference data)	42.8	47.7	52.5	
	FPWM1	(Reference data)	21.4	23.8	26.3	
OSC frequency	OSC	When R = 20 kΩ and C = 180 pF (Reference data)	10.98	12.2	13.42	MHz
Masking time of over current detection circuit	T _{ISD}	(Reference data)	—	3	—	μs
Threshold current of over current detection circuit	I _{ISD}	(Reference data)	3	4.5	6	A
Threshold temperature of thermal shutdown circuit	TSD	(Reference data)	—	165	—	°C
	TSD _{hys}	Hysteresis width (Reference data)	—	15	—	
UVLO detection voltage at the VM pin	VMUVLO	—	3.1	3.4	3.7	V
UVLO releasing voltage at the VM pin	VMUVLOR	—	3.4	3.7	3.98	V
UVLO detection voltage at the VREG pin	VREGUVLO	—	2.7	3.0	3.3	V
UVLO releasing voltage at the VREG pin	VREGUVLOR	—	2.9	3.2	3.45	V
VREG output voltage	VREG1	When IVREG = -5 mA	4.5	5	5.5	V
	VREG2	When IVREG = -5 mA, VM = 4.0 V	3.6	3.9	4.0	V

Note: Reference data means that the data is not implemented testing before shipping.

Application Circuit Example

Some of the functional blocks, circuits, or constants in the block diagram may be omitted or simplified for explanatory purposes.

The application circuits shown in this document are provided for reference purposes only. Thorough evaluation is required, especially at the mass production design stage.

Providing these application circuit examples does not grant a license for industrial property rights.

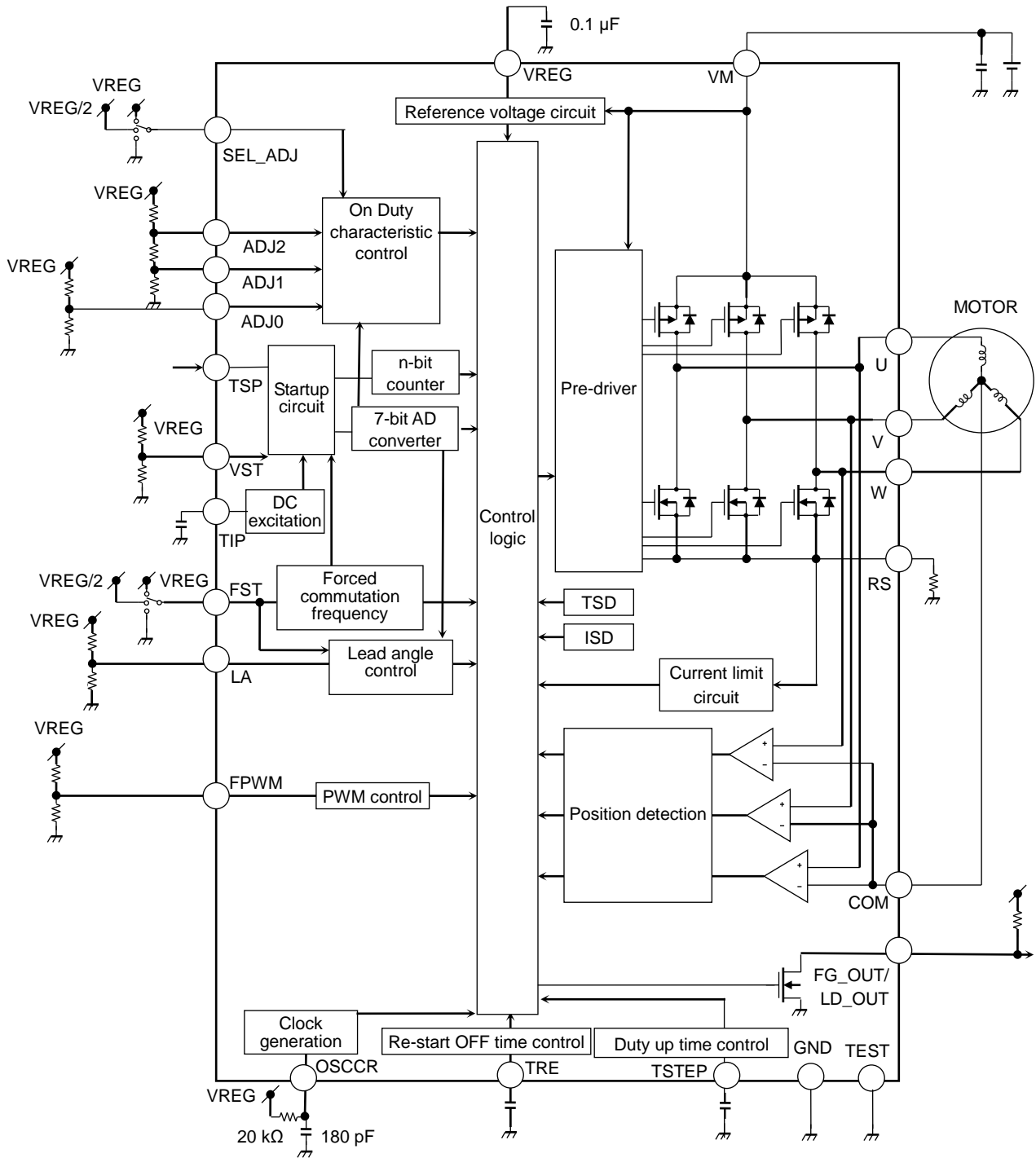

Package Dimensions

P-WQFN24-0404-0.50-004

Unit: mm

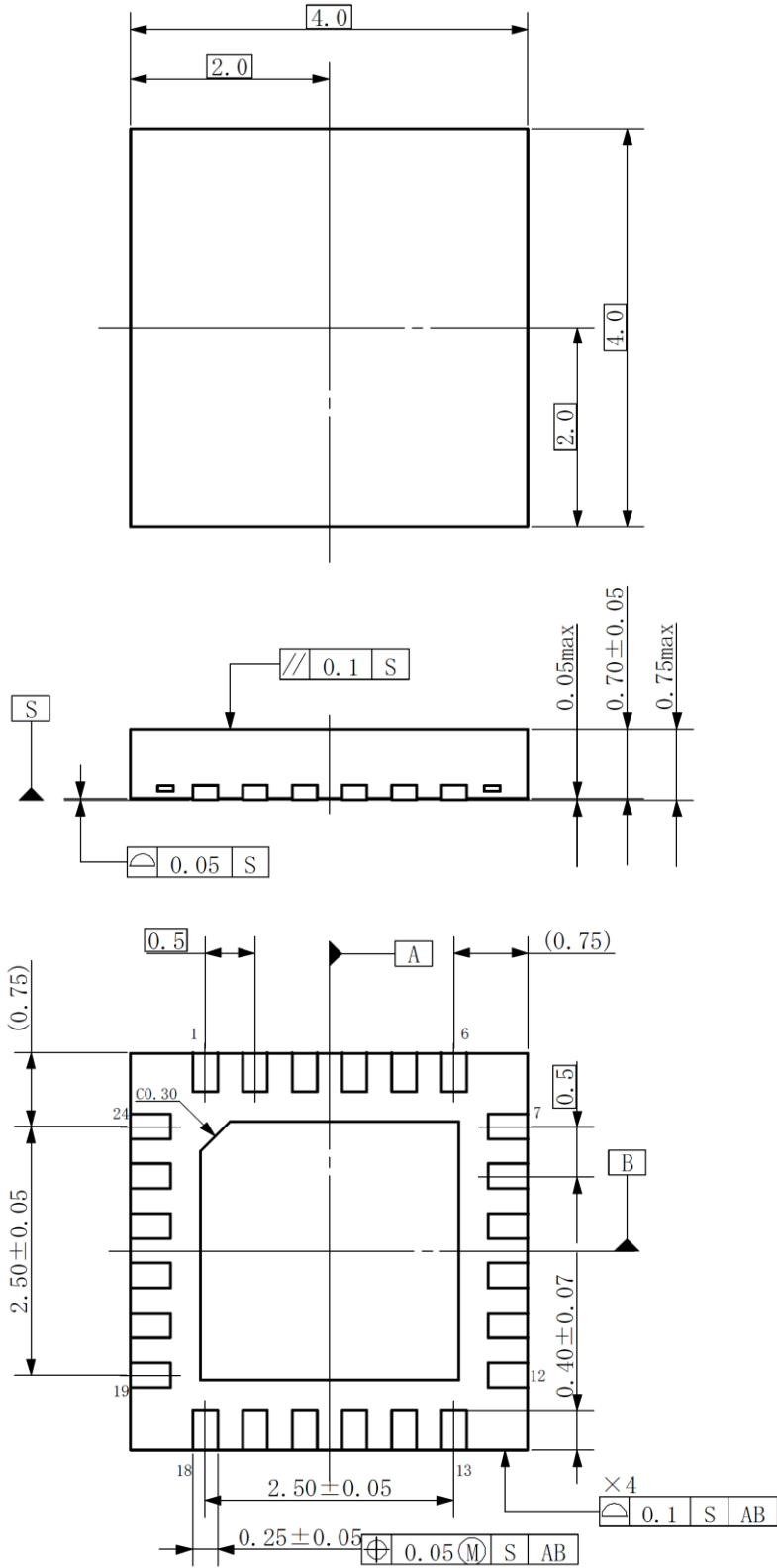

Weight: 0.04 g (typ.)

SSOP24-P-300-0.65A

Unit: mm

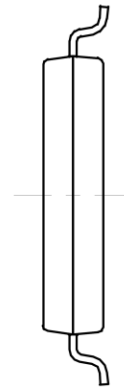
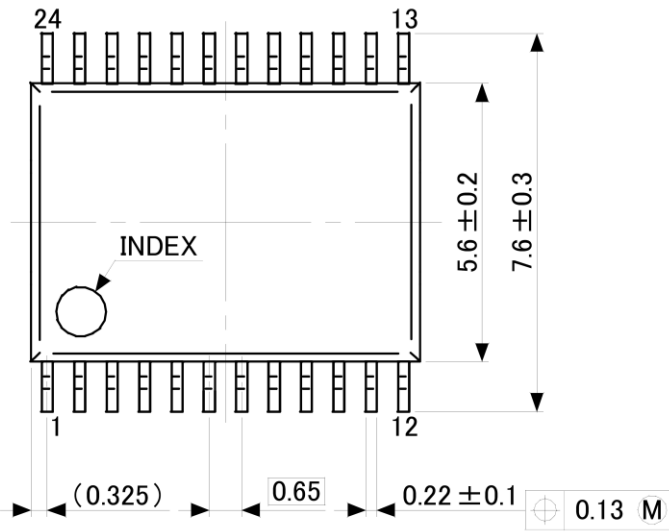

Detail figure of pin tip shape

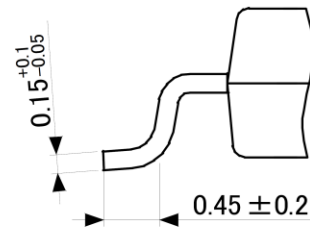
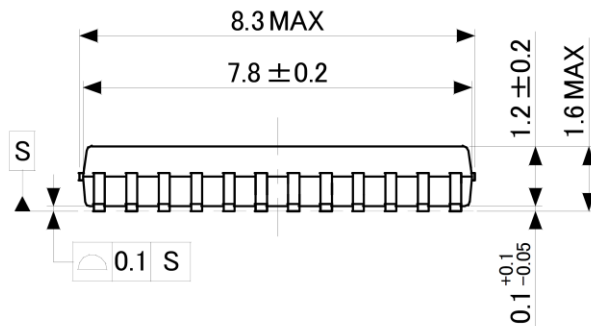

Weight: 0.13 g (typ.)

Notes on Contents

1. Block Diagrams

Some of the functional blocks, circuits, or constants in the block diagram may be omitted or simplified for explanatory purposes.

2. Equivalent Circuits

The equivalent circuit diagrams may be simplified or some parts of them may be omitted for explanatory purposes.

3. Timing Charts

Timing charts may be simplified for explanatory purposes.

4. Application Circuits

The application circuits shown in this document are provided for reference purposes only. Thorough evaluation is required, especially at the mass production design stage.

Providing these application circuit examples does not grant a license for industrial property rights.

5. Test Circuits

Components in the test circuits are used only to obtain and confirm the device characteristics. These components and circuits are not guaranteed to prevent malfunction or failure from occurring in the application equipment.

IC Usage Considerations

Notes on handling of ICs

- (1) The absolute maximum ratings of a semiconductor device are a set of ratings that must not be exceeded, even for a moment. Do not exceed any of these ratings.
Exceeding the rating(s) may cause the device breakdown, damage or deterioration, and may result injury by explosion or combustion.
- (2) Use an appropriate power supply fuse to ensure that a large current does not continuously flow in case of over current and/or IC failure. The IC will fully break down when used under conditions that exceed its absolute maximum ratings, when the wiring is routed improperly or when an abnormal pulse noise occurs from the wiring or load, causing a large current to continuously flow and the breakdown can lead smoke or ignition. To minimize the effects of the flow of a large current in case of breakdown, appropriate settings, such as fuse capacity, fusing time and insertion circuit location, are required.
- (3) If your design includes an inductive load such as a motor coil, incorporate a protection circuit into the design to prevent device malfunction or breakdown caused by the current resulting from the inrush current at power ON or the negative current resulting from the back electromotive force at power OFF. IC breakdown may cause injury, smoke or ignition.
Use a stable power supply with ICs with built-in protection functions. If the power supply is unstable, the protection function may not operate, causing IC breakdown. IC breakdown may cause injury, smoke or ignition.
- (4) Do not insert devices in the wrong orientation or incorrectly.
Make sure that the positive and negative terminals of power supplies are connected properly. Otherwise, the current or power consumption may exceed the absolute maximum rating, and exceeding the rating(s) may cause the device breakdown, damage or deterioration, and may result injury by explosion or combustion.
In addition, do not use any device that is applied the current with inserting in the wrong orientation or incorrectly even just one time.

- (5) Carefully select external components (such as inputs and negative feedback capacitors) and load components (such as speakers), for example, power amp and regulator.
- If there is a large amount of leakage current such as input or negative feedback condenser, the IC output DC voltage will increase. If this output voltage is connected to a speaker with low input withstand voltage, overcurrent or IC failure can cause smoke or ignition. (The over current can cause smoke or ignition from the IC itself.) In particular, please pay attention when using a Bridge Tied Load (BTL) connection type IC that inputs output DC voltage to a speaker directly.

Points to remember on handling of ICs

- (1) Over current detection Circuit
- Over current detection circuits (referred to as current limiter circuits) do not necessarily protect ICs under all circumstances. If the Over current detection circuits operate against the over current, clear the over current status immediately.
- Depending on the method of use and usage conditions, such as exceeding absolute maximum ratings can cause the over current detection circuit to not operate properly or IC breakdown before operation. In addition, depending on the method of use and usage conditions, if over current continues to flow for a long time after operation, the IC may generate heat resulting in breakdown.
- (2) Thermal Shutdown Circuit
- Thermal shutdown circuits do not necessarily protect ICs under all circumstances. If the thermal shutdown circuits operate against the over temperature, clear the heat generation status immediately. Depending on the method of use and usage conditions, such as exceeding absolute maximum ratings can cause the thermal shutdown circuit to not operate properly or IC breakdown before operation.
- (3) Heat Radiation Design
- In using an IC with large current flow such as power amp, regulator or driver, please design the device so that heat is appropriately radiated, not to exceed the specified junction temperature (T_j) at any time and condition. These ICs generate heat even during normal use. An inadequate IC heat radiation design can lead to decrease in IC life, deterioration of IC characteristics or IC breakdown. In addition, please design the device taking into consideration the effect of IC heat radiation with peripheral components.
- (4) Back-EMF
- When a motor reverses the rotation direction, stops or slows down abruptly, a current flow back to the motor's power supply due to the effect of back-EMF. If the current sink capability of the power supply is small, the device's motor power supply and output pins might be exposed to conditions beyond absolute maximum ratings. To avoid this problem, take the effect of back-EMF into consideration in system design.

RESTRICTIONS ON PRODUCT USE

Toshiba Corporation and its subsidiaries and affiliates are collectively referred to as "TOSHIBA".

Hardware, software and systems described in this document are collectively referred to as "Product".

- TOSHIBA reserves the right to make changes to the information in this document and related Product without notice.
- This document and any information herein may not be reproduced without prior written permission from TOSHIBA. Even with TOSHIBA's written permission, reproduction is permissible only if reproduction is without alteration/omission.
- Though TOSHIBA works continually to improve Product's quality and reliability, Product can malfunction or fail. Customers are responsible for complying with safety standards and for providing adequate designs and safeguards for their hardware, software and systems which minimize risk and avoid situations in which a malfunction or failure of Product could cause loss of human life, bodily injury or damage to property, including data loss or corruption. Before customers use the Product, create designs including the Product, or incorporate the Product into their own applications, customers must also refer to and comply with (a) the latest versions of all relevant TOSHIBA information, including without limitation, this document, the specifications, the data sheets and application notes for Product and the precautions and conditions set forth in the "TOSHIBA Semiconductor Reliability Handbook" and (b) the instructions for the application with which the Product will be used with or for. Customers are solely responsible for all aspects of their own product design or applications, including but not limited to (a) determining the appropriateness of the use of this Product in such design or applications; (b) evaluating and determining the applicability of any information contained in this document, or in charts, diagrams, programs, algorithms, sample application circuits, or any other referenced documents; and (c) validating all operating parameters for such designs and applications. **TOSHIBA ASSUMES NO LIABILITY FOR CUSTOMERS' PRODUCT DESIGN OR APPLICATIONS.**
- **PRODUCT IS NEITHER INTENDED NOR WARRANTED FOR USE IN EQUIPMENTS OR SYSTEMS THAT REQUIRE EXTRAORDINARILY HIGH LEVELS OF QUALITY AND/OR RELIABILITY, AND/OR A MALFUNCTION OR FAILURE OF WHICH MAY CAUSE LOSS OF HUMAN LIFE, BODILY INJURY, SERIOUS PROPERTY DAMAGE AND/OR SERIOUS PUBLIC IMPACT ("UNINTENDED USE").** Except for specific applications as expressly stated in this document, Unintended Use includes, without limitation, equipment used in nuclear facilities, equipment used in the aerospace industry, lifesaving and/or life supporting medical equipment, equipment used for automobiles, trains, ships and other transportation, traffic signaling equipment, equipment used to control combustions or explosions, safety devices, elevators and escalators, and devices related to power plant. **IF YOU USE PRODUCT FOR UNINTENDED USE, TOSHIBA ASSUMES NO LIABILITY FOR PRODUCT.** For details, please contact your TOSHIBA sales representative or contact us via our website.
- Do not disassemble, analyze, reverse-engineer, alter, modify, translate or copy Product, whether in whole or in part.
- Product shall not be used for or incorporated into any products or systems whose manufacture, use, or sale is prohibited under any applicable laws or regulations.
- The information contained herein is presented only as guidance for Product use. No responsibility is assumed by TOSHIBA for any infringement of patents or any other intellectual property rights of third parties that may result from the use of Product. No license to any intellectual property right is granted by this document, whether express or implied, by estoppel or otherwise.
- **ABSENT A WRITTEN SIGNED AGREEMENT, EXCEPT AS PROVIDED IN THE RELEVANT TERMS AND CONDITIONS OF SALE FOR PRODUCT, AND TO THE MAXIMUM EXTENT ALLOWABLE BY LAW, TOSHIBA (1) ASSUMES NO LIABILITY WHATSOEVER, INCLUDING WITHOUT LIMITATION, INDIRECT, CONSEQUENTIAL, SPECIAL, OR INCIDENTAL DAMAGES OR LOSS, INCLUDING WITHOUT LIMITATION, LOSS OF PROFITS, LOSS OF OPPORTUNITIES, BUSINESS INTERRUPTION AND LOSS OF DATA, AND (2) DISCLAIMS ANY AND ALL EXPRESS OR IMPLIED WARRANTIES AND CONDITIONS RELATED TO SALE, USE OF PRODUCT, OR INFORMATION, INCLUDING WARRANTIES OR CONDITIONS OF MERCHANTABILITY, FITNESS FOR A PARTICULAR PURPOSE, ACCURACY OF INFORMATION, OR NONINFRINGEMENT.**
- Do not use or otherwise make available Product or related software or technology for any military purposes, including without limitation, for the design, development, use, stockpiling or manufacturing of nuclear, chemical, or biological weapons or missile technology products (mass destruction weapons). Product and related software and technology may be controlled under the applicable export laws and regulations including, without limitation, the Japanese Foreign Exchange and Foreign Trade Law and the U.S. Export Administration Regulations. Export and re-export of Product or related software or technology are strictly prohibited except in compliance with all applicable export laws and regulations.
- Please contact your TOSHIBA sales representative for details as to environmental matters such as the RoHS compatibility of Product. Please use Product in compliance with all applicable laws and regulations that regulate the inclusion or use of controlled substances, including without limitation, the EU RoHS Directive. **TOSHIBA ASSUMES NO LIABILITY FOR DAMAGES OR LOSSES OCCURRING AS A RESULT OF NONCOMPLIANCE WITH APPLICABLE LAWS AND REGULATIONS.**

Mouser Electronics

Authorized Distributor

Click to View Pricing, Inventory, Delivery & Lifecycle Information:

[Toshiba:](#)

[TB67B008FNG,EL](#)