

LM2941QML 1A Low Dropout Adjustable Regulator

 Check for Samples: [LM2941QML](#), [LM2941QML-SP](#)

FEATURES

- Available with Radiation Ensure
 - ELDRS Free 100 krad(Si)
- Output Voltage Adjustable from 5V to 20V
- Dropout Voltage Typically 0.5V at $I_O = 1A$
- Output Current in Excess of 1A
- Trimmed Reference Voltage
- Reverse Battery Protection
- Internal Short Circuit Current Limit
- Mirror Image Insertion Protection
- TTL, CMOS Compatible ON/OFF Switch

DESCRIPTION

The LM2941 positive voltage regulator features the ability to source 1A of output current with a typical dropout voltage of 0.5V and a maximum of 1V over the entire temperature range. Furthermore, a quiescent current reduction circuit has been included which reduces the ground pin current when the differential between the input voltage and the output voltage exceeds approximately 3V. The quiescent current with 1A of output current and an input-output differential of 5V is therefore only 30mA. Higher quiescent currents only exist when the regulator is in the dropout mode ($V_I - V_O \leq 3V$).

Originally designed for vehicular applications, the LM2941 and all regulated circuitry are protected from reverse battery installations or two-battery jumps. During line transients, such as load dump when the input voltage can momentarily exceed the specified maximum operating voltage, the regulator will automatically shut down to protect both the internal circuits and the load. Familiar regulator features such as short circuit and thermal overload protection are also provided.

Connection Diagram

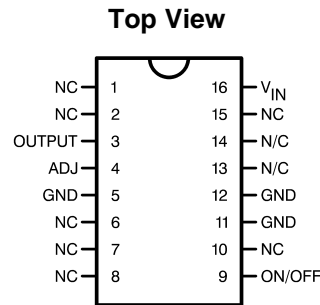

Figure 1. 16-Lead CFP Package



Please be aware that an important notice concerning availability, standard warranty, and use in critical applications of Texas Instruments semiconductor products and disclaimers thereto appears at the end of this data sheet.

All trademarks are the property of their respective owners.

Equivalent Schematic Diagram

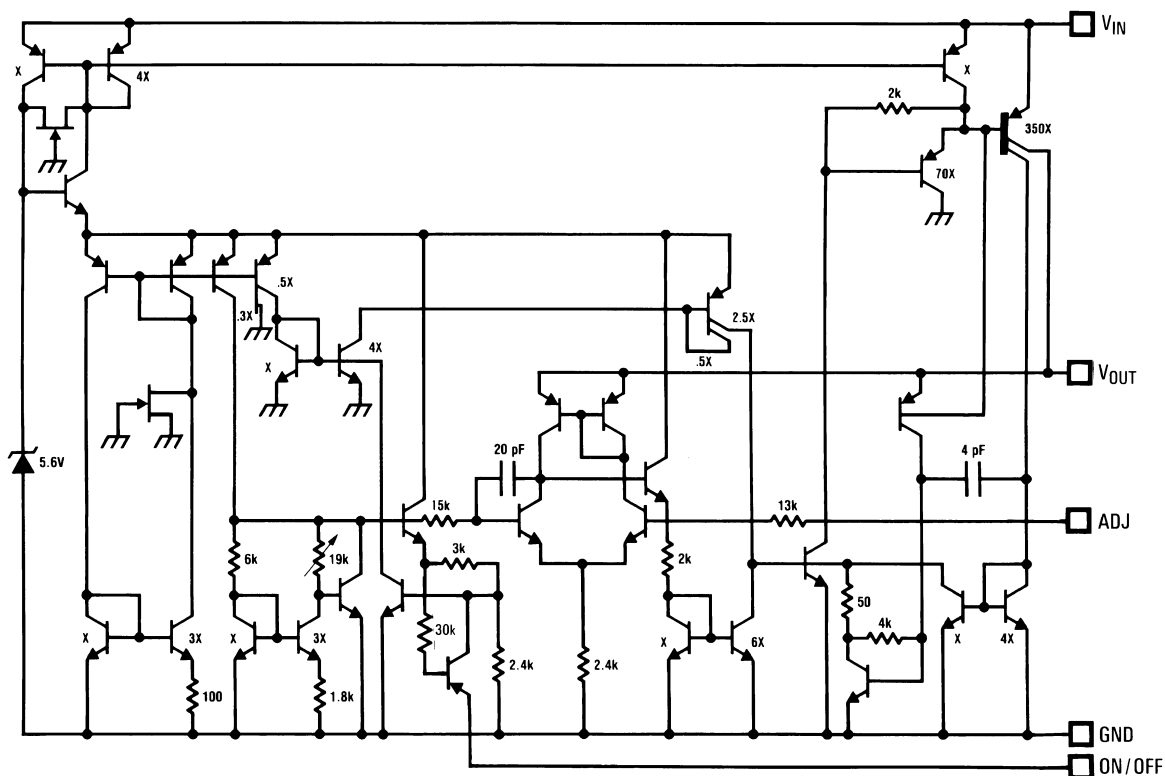

These devices have limited built-in ESD protection. The leads should be shorted together or the device placed in conductive foam during storage or handling to prevent electrostatic damage to the MOS gates.

Absolute Maximum Ratings⁽¹⁾

Input Voltage (Survival Voltage, $\leq 100\text{ms}$)		60V	
Internal Power Dissipation ⁽²⁾		Internally Limited	
Maximum Junction Temperature		150°C	
Storage Temperature Range		$-65^\circ\text{C} \leq T_J \leq +150^\circ\text{C}$	
Lead Temperature (Soldering, 10 seconds)		300°C	
Thermal Resistance	θ_{JA}	CFP "WG" (device 01, 02) (Still Air)	122°C/W
		CFP "WG" (device 01, 02) (500LF/Min Air Flow)	77°C/W
		CFP "GW" (device 03, 04) (Still Air)	136°C/W
		CFP "GW" (device 03, 04) (500LF/Min Air Flow)	87°C/W
	θ_{JC}	CFP "WG" (device 01, 02) ⁽³⁾	5°C/W
		CFP "GW" (device 03, 04)	13°C/W
Package Weight (Typ)	CFP "WG" (device 01, 02)	360mg	
	CFP "GW" (device 03, 04)	410mg	
ESD susceptibility to be determined ⁽⁴⁾		500V	

- (1) Absolute Maximum Ratings indicate limits beyond which damage to the device may occur. Operating Ratings indicate conditions for which the device is functional, but do not ensure specific performance limits. For specified specifications and test conditions, see the Electrical Characteristics. The ensured specifications apply only for the test conditions listed. Some performance characteristics may degrade when the device is not operated under the listed test conditions.
- (2) The maximum power dissipation must be derated at elevated temperatures and is dictated by T_{Jmax} (maximum junction temperature), θ_{JA} (package junction to ambient thermal resistance), and T_A (ambient temperature). The maximum allowable power dissipation at any temperature is $P_{Dmax} = (T_{Jmax} - T_A)/\theta_{JA}$ or the number given in the Absolute Maximum Ratings, whichever is lower.
- (3) The package material for these devices allows much improved heat transfer over our standard ceramic packages. In order to take full advantage of this improved heat transfer, heat sinking must be provided between the package base (directly beneath the die), and either metal traces on, or thermal vias through, the printed circuit board. Without this additional heat sinking, device power dissipation must be calculated using θ_{JA} , rather than θ_{JC} , thermal resistance. It must not be assumed that the device leads will provide substantial heat transfer out of the package, since the thermal resistance of the lead frame material is very poor, relative to the material of the package base. The stated θ_{JC} thermal resistance is for the package material only, and does not account for the additional thermal resistance between the package base and the printed circuit board. The user must determine the value of the additional thermal resistance and must combine this with the stated value for the package, to calculate the total allowed power dissipation for the device.
- (4) Human body model, 1.5 k Ω in series with 100 pF.

Recommended Operating Conditions

Maximum Input Voltage	26V
Temperature Range	$-55^\circ\text{C} \leq T_A \leq 125^\circ\text{C}$

Table 1. Quality Conformance Inspection Mil-Std-883, Method 5005 - Group A

Subgroup	Description	Temp °C
1	Static tests at	+25
2	Static tests at	+125
3	Static tests at	-55
4	Dynamic tests at	+25
5	Dynamic tests at	+125
6	Dynamic tests at	-55
7	Functional tests at	+25
8A	Functional tests at	+125
8B	Functional tests at	-55
9	Switching tests at	+25
10	Switching tests at	+125
11	Switching tests at	-55
12	Settling time at	+25
13	Settling time at	+125
14	Settling time at	-55

LM2941 Electrical Characteristics DC Parameters

The following conditions apply, unless otherwise specified.

DC: $5V \leq V_O \leq 20V$, $V_{IN} = V_O + 5V$, $C_O = 22\mu F$

Parameter		Test Conditions	Notes	Min	Max	Unit	Sub-groups
V _{Ref}	Reference Voltage	$5mA \leq I_O \leq 1A$		1.237	1.313	V	1
				1.211	1.339	V	2, 3
V _{RLine}	Line Regulation	$V_O + 2V \leq V_{IN} \leq 26V$, $I_O = 5mA$	See ⁽¹⁾		10	mV/V	1, 2, 3
V _{RLoad}	Load Regulation	$50mA \leq I_O \leq 1A$, $V_{IN} = 10V$, $V_{OUT} = 5V$	See ⁽¹⁾		10	mV/V	1, 2, 3
		$50mA \leq I_O \leq 1A$, $V_{IN} = 25V$, $V_{OUT} = 20V$			10	mV/V	1, 2, 3
I _Q	Quiescent Current	$V_O + 2V \leq V_{IN} \leq 26V$, $I_O = 5mA$			15	mA	1
					20	mA	2, 3
		$V_{IN} = V_O + 5V$, $I_O = 1A$			45	mA	1
V _{DO}	Dropout Voltage	$I_O = 1A$			0.8	V	1
					1.0	V	2, 3
					200	mV	1
I _{SC}	Short Circuit Current	$V_{IN Max} = 26V$		1.6	3.5	A	1
				1.3	3.7	A	2, 3
	Maximum Operational Input Voltage		See ⁽²⁾		26	V _{DC}	1, 2, 3
	Reverse Polarity DC Input Voltage	$R_O = 100\Omega$, $V_O \geq -0.6V$	See ⁽³⁾	-15		V	1, 2, 3
V _{TH On}	ON/OFF Threshold Voltage ON	$I_O \leq 1A$	See ⁽³⁾		0.8	V	1, 2, 3
V _{TH Off}	ON/OFF Threshold Voltage OFF	$I_O \leq 1A$	See ⁽³⁾	2.00		V	1, 2, 3
	ON/OFF Threshold Current	$V_{ON/OFF} = 2.0V$, $I_O \leq 1A$			100	μA	1
					300	μA	2, 3

- (1) Limit = mV per volt of V_O.
- (2) Condition for V_{IN}
- (3) Functional test go-no-go only.

LM2941 Electrical Characteristics AC Parameters

The following conditions apply, unless otherwise specified.

AC: $5V \leq V_O \leq 20V$, $V_{IN} = V_O + 5V$, $C_O = 22\mu F$

Parameter		Test Conditions	Notes	Min	Max	Unit	Sub-groups
	Maximum Line Transient	$V_{O\ Max}$ 1V above nominal V_O , $R_O = 100\Omega$, $t \leq 100mS$		60		V	4, 5, 6
	Reverse Polarity Transient Input Voltage	$t \leq 100mS$, $R_O = 100\Omega$		-50		V	4, 5, 6
RR	Ripple Rejection	$f_O = 1KHz$, $1 V_{RMS}$, $I_L = 100mA$	See ⁽¹⁾		0.02	%/V	4
		$f_O = 1KHz$, $1 V_{RMS}$, $I_L = 100mA$	See ⁽¹⁾		0.04	%/V	5, 6

(1) %/V = % of V_{IN} per Volt of V_O .

LM2941 Electrical Characteristics DC Drift Parameters

The following conditions apply, unless otherwise specified.

DC: $5V \leq V_O \leq 20V$, $V_{IN} = V_O + 5V$, $C_O = 22\mu F$

Delta calculations performed on QMLV devices at group B , subgroup 5.

Parameter		Test Conditions	Notes	Min	Max	Unit	Sub-groups
V_{Ref}	Reference Voltage	$5mA \leq I_O \leq 1A$		-25	+25	mV	1

Typical Performance Characteristics

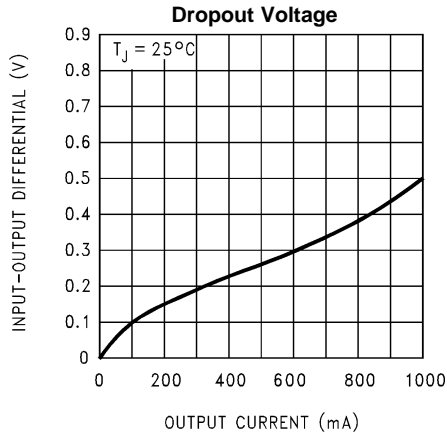

Figure 2.

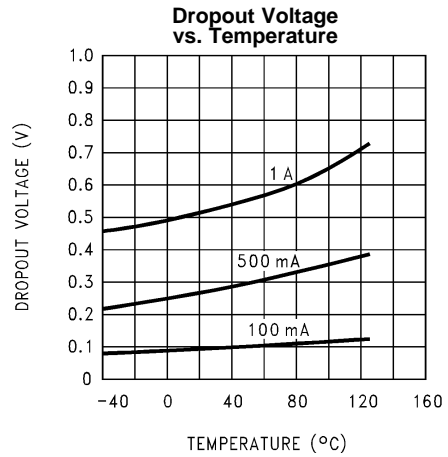

Figure 3.

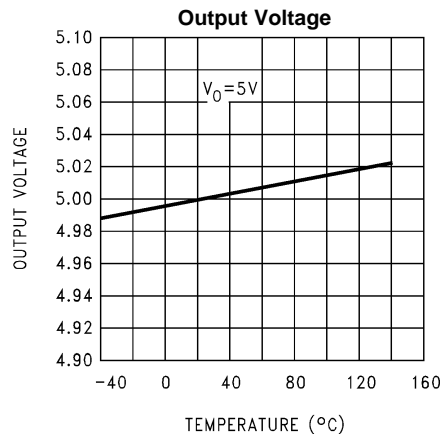

Figure 4.

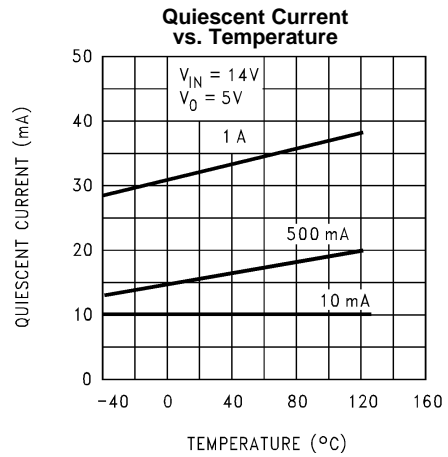

Figure 5.

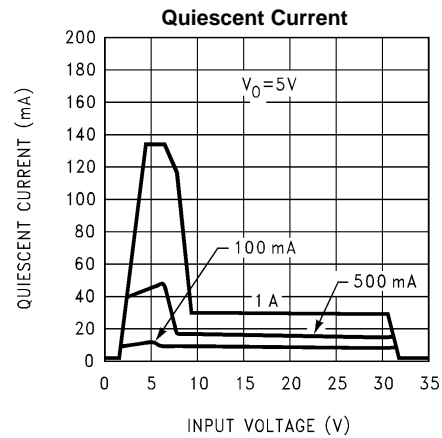

Figure 6.

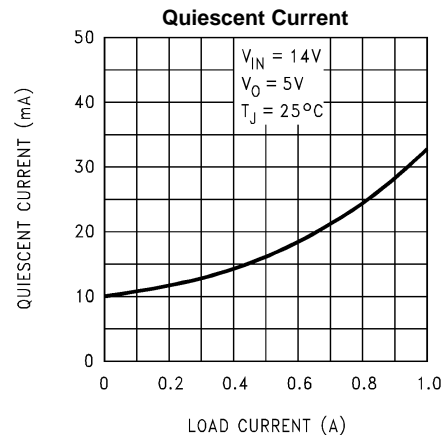

Figure 7.

Typical Performance Characteristics (continued)

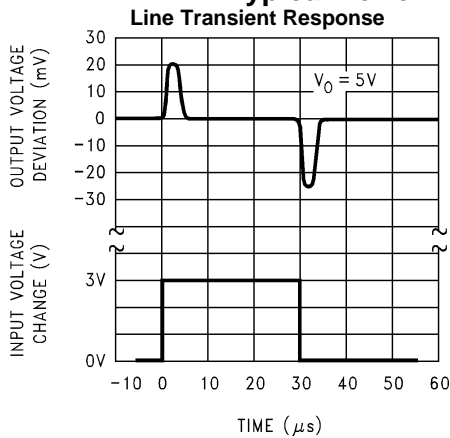

Figure 8.

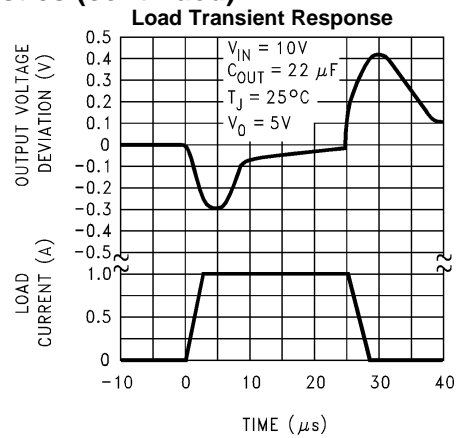

Figure 9.

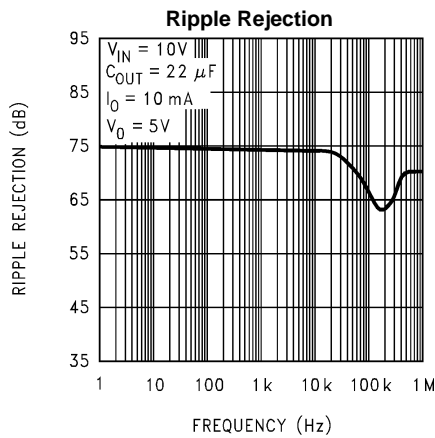

Figure 10.

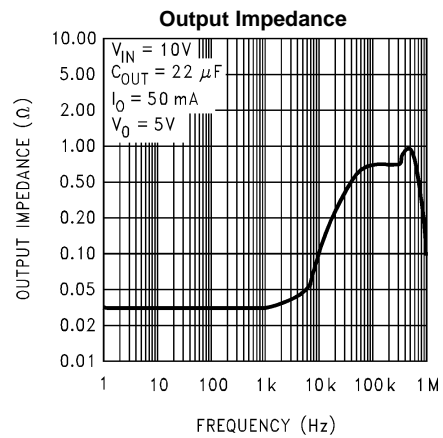

Figure 11.

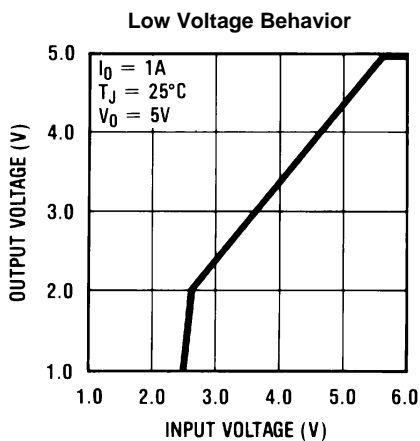

Figure 12.

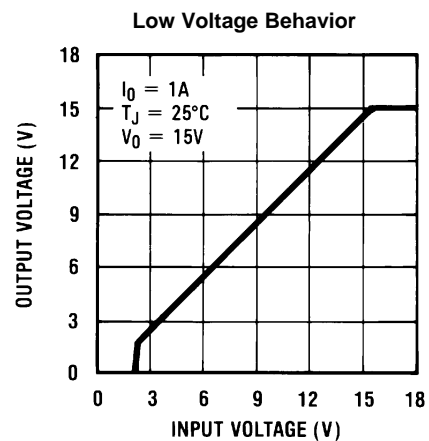

Figure 13.

Typical Performance Characteristics (continued)

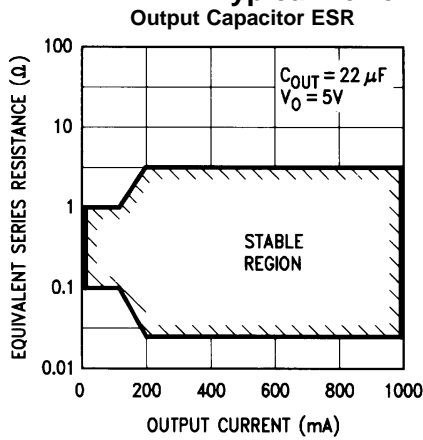

Figure 14.

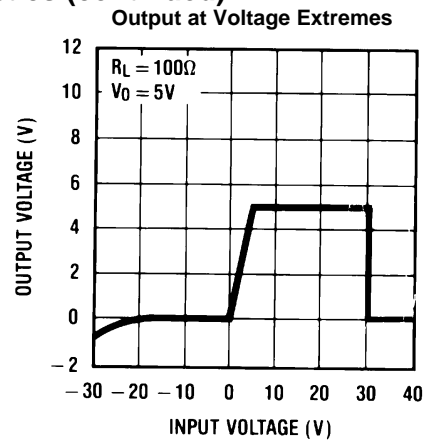

Figure 15.

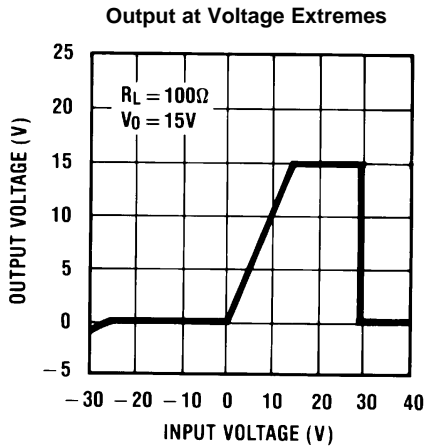

Figure 16.

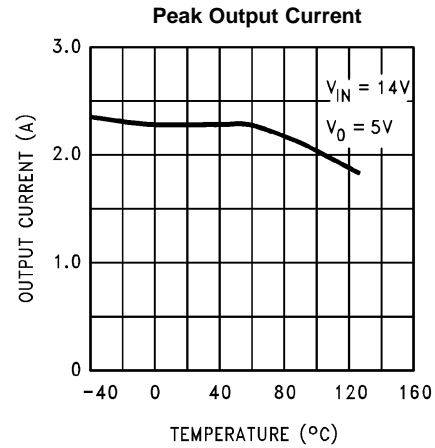
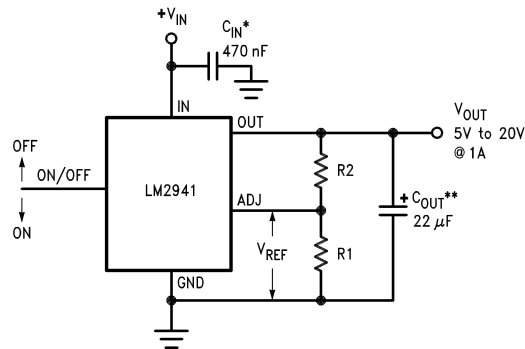

Figure 17.

Typical Applications



$$V_{OUT} = \text{Reference voltage} \times \frac{R1 + R2}{R1} \text{ where } V_{REF} = 1.275 \text{ typical}$$

$$\text{Solving for R2: } R2 = R1 \left(\frac{V_O}{V_{REF}} - 1 \right)$$

Note: Using 1KΩ for R1 will ensure that the input bias current error of the adjust pin will be negligible. Do not bypass R1 or R2. This will lead to instabilities.

* Required if regulator is located far from power supply filter.

** C_O must be at least 22μF to maintain stability. May be increased without bound to maintain regulation during transients. Locate as close as possible to the regulator. This capacitor must be rated over the same operating temperature range as the regulator and the ESR is critical; see curve.

Figure 18. 5V to 20V Adjustable Regulator

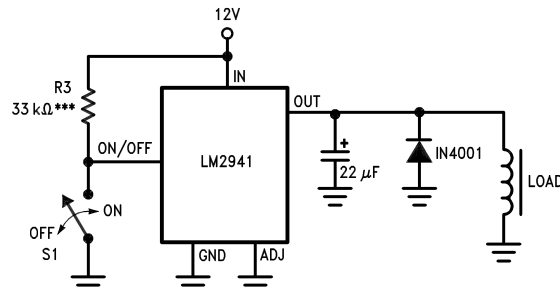

*** To assure shutdown, select Resistor R3 to ensure at least 300μA of pull-up current when S1 is open. (Assume 2V at the ON/OFF pin.)

Figure 19. 1A Switch

REVISION HISTORY SECTION

Released	Revision	Section	Changes
08/25/09	A	New Release, Corporate format	1 MDS data sheet converted into one Corp. data sheet format. Added Radiation products to ordering table. MNLM2941-X Rev 4A1 will be archived.
12–Oct-2011	B	Ordering Information, Absolute Max Ratings	Ordering Information — Added LM2941GW/883, LM2941GW-QMLV and LM2941GWRLQMLV. Absolute Max — Added Theta JA and Theta JC along with Package weight of 'GW' devices. RatingsLM2941QML Rev A will be archived.

REVISION HISTORY

Changes from Revision A (April 2013) to Revision B	Page
<ul style="list-style-type: none">• Changed layout of National Data Sheet to TI format	9

PACKAGING INFORMATION

Orderable Device	Status (1)	Package Type	Package Drawing	Pins	Package Qty	Eco Plan (2)	Lead/Ball Finish (6)	MSL Peak Temp (3)	Op Temp (°C)	Device Marking (4/5)	Samples
5962-9166703QYA	ACTIVE	CFP	NAC	16	42	TBD	Call TI	Call TI	-55 to 125	LM2941GW /883 Q 5962-91667 03QYA ACO 03QYA >T	Samples
5962-9166703VYA	ACTIVE	CFP	NAC	16	42	TBD	Call TI	Call TI	-55 to 125	LM2941GW- QMLV Q 5962-91667 03VYA ACO 03VYA >T	Samples
5962R9166702V9A	ACTIVE	DIESALE	Y	0	34	Green (RoHS & no Sb/Br)	Call TI	Level-1-NA-UNLIM	-55 to 125		Samples
5962R9166704VYA	ACTIVE	CFP	NAC	16	42	TBD	Call TI	Call TI	-55 to 125	LM2941GWRL QMLV Q 5962R91667 04VYA ACO 04VYA >T	Samples
LM2941 MDE	ACTIVE	DIESALE	Y	0	34	Green (RoHS & no Sb/Br)	Call TI	Level-1-NA-UNLIM	-55 to 125		Samples
LM2941-MD8	ACTIVE	DIESALE	Y	0	221	Green (RoHS & no Sb/Br)	Call TI	Level-1-NA-UNLIM			Samples
LM2941GW-QMLV	ACTIVE	CFP	NAC	16	42	TBD	Call TI	Call TI	-55 to 125	LM2941GW- QMLV Q 5962-91667 03VYA ACO 03VYA >T	Samples
LM2941GW/883	ACTIVE	CFP	NAC	16	42	TBD	Call TI	Call TI	-55 to 125	LM2941GW /883 Q 5962-91667 03QYA ACO 03QYA >T	Samples
LM2941GWRLQMLV	ACTIVE	CFP	NAC	16	42	TBD	Call TI	Call TI	-55 to 125	LM2941GWRL QMLV Q 5962R91667 04VYA ACO 04VYA >T	Samples

(1) The marketing status values are defined as follows:

ACTIVE: Product device recommended for new designs.

LIFEBUY: TI has announced that the device will be discontinued, and a lifetime-buy period is in effect.

NRND: Not recommended for new designs. Device is in production to support existing customers, but TI does not recommend using this part in a new design.

PREVIEW: Device has been announced but is not in production. Samples may or may not be available.

OBSOLETE: TI has discontinued the production of the device.

(2) Eco Plan - The planned eco-friendly classification: Pb-Free (RoHS), Pb-Free (RoHS Exempt), or Green (RoHS & no Sb/Br) - please check <http://www.ti.com/productcontent> for the latest availability information and additional product content details.

TBD: The Pb-Free/Green conversion plan has not been defined.

Pb-Free (RoHS): TI's terms "Lead-Free" or "Pb-Free" mean semiconductor products that are compatible with the current RoHS requirements for all 6 substances, including the requirement that lead not exceed 0.1% by weight in homogeneous materials. Where designed to be soldered at high temperatures, TI Pb-Free products are suitable for use in specified lead-free processes.

Pb-Free (RoHS Exempt): This component has a RoHS exemption for either 1) lead-based flip-chip solder bumps used between the die and package, or 2) lead-based die adhesive used between the die and leadframe. The component is otherwise considered Pb-Free (RoHS compatible) as defined above.

Green (RoHS & no Sb/Br): TI defines "Green" to mean Pb-Free (RoHS compatible), and free of Bromine (Br) and Antimony (Sb) based flame retardants (Br or Sb do not exceed 0.1% by weight in homogeneous material)

(3) MSL, Peak Temp. - The Moisture Sensitivity Level rating according to the JEDEC industry standard classifications, and peak solder temperature.

(4) There may be additional marking, which relates to the logo, the lot trace code information, or the environmental category on the device.

(5) Multiple Device Markings will be inside parentheses. Only one Device Marking contained in parentheses and separated by a "~" will appear on a device. If a line is indented then it is a continuation of the previous line and the two combined represent the entire Device Marking for that device.

(6) Lead/Ball Finish - Orderable Devices may have multiple material finish options. Finish options are separated by a vertical ruled line. Lead/Ball Finish values may wrap to two lines if the finish value exceeds the maximum column width.

Important Information and Disclaimer: The information provided on this page represents TI's knowledge and belief as of the date that it is provided. TI bases its knowledge and belief on information provided by third parties, and makes no representation or warranty as to the accuracy of such information. Efforts are underway to better integrate information from third parties. TI has taken and continues to take reasonable steps to provide representative and accurate information but may not have conducted destructive testing or chemical analysis on incoming materials and chemicals. TI and TI suppliers consider certain information to be proprietary, and thus CAS numbers and other limited information may not be available for release.

In no event shall TI's liability arising out of such information exceed the total purchase price of the TI part(s) at issue in this document sold by TI to Customer on an annual basis.

OTHER QUALIFIED VERSIONS OF LM2941QML, LM2941QML-SP :

● Military: [LM2941QML](#)

● Space: [LM2941QML-SP](#)

NOTE: Qualified Version Definitions:

- Military - QML certified for Military and Defense Applications
- Space - Radiation tolerant, ceramic packaging and qualified for use in Space-based application

NAC0016A

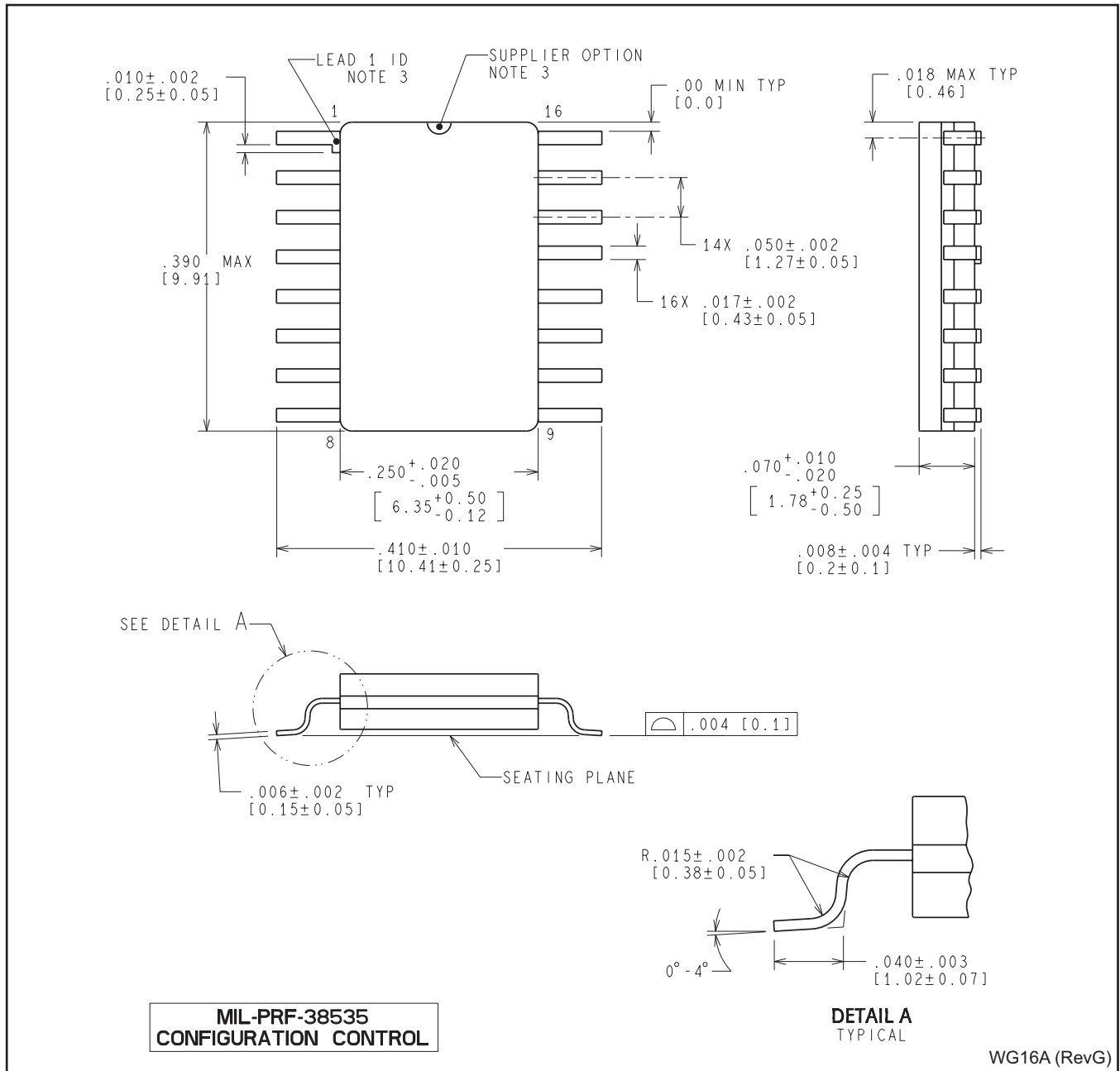

IMPORTANT NOTICE

Texas Instruments Incorporated (TI) reserves the right to make corrections, enhancements, improvements and other changes to its semiconductor products and services per JESD46, latest issue, and to discontinue any product or service per JESD48, latest issue. Buyers should obtain the latest relevant information before placing orders and should verify that such information is current and complete.

TI's published terms of sale for semiconductor products (<http://www.ti.com/sc/docs/stdterms.htm>) apply to the sale of packaged integrated circuit products that TI has qualified and released to market. Additional terms may apply to the use or sale of other types of TI products and services.

Reproduction of significant portions of TI information in TI data sheets is permissible only if reproduction is without alteration and is accompanied by all associated warranties, conditions, limitations, and notices. TI is not responsible or liable for such reproduced documentation. Information of third parties may be subject to additional restrictions. Resale of TI products or services with statements different from or beyond the parameters stated by TI for that product or service voids all express and any implied warranties for the associated TI product or service and is an unfair and deceptive business practice. TI is not responsible or liable for any such statements.

Buyers and others who are developing systems that incorporate TI products (collectively, "Designers") understand and agree that Designers remain responsible for using their independent analysis, evaluation and judgment in designing their applications and that Designers have full and exclusive responsibility to assure the safety of Designers' applications and compliance of their applications (and of all TI products used in or for Designers' applications) with all applicable regulations, laws and other applicable requirements. Designer represents that, with respect to their applications, Designer has all the necessary expertise to create and implement safeguards that (1) anticipate dangerous consequences of failures, (2) monitor failures and their consequences, and (3) lessen the likelihood of failures that might cause harm and take appropriate actions. Designer agrees that prior to using or distributing any applications that include TI products, Designer will thoroughly test such applications and the functionality of such TI products as used in such applications.

TI's provision of technical, application or other design advice, quality characterization, reliability data or other services or information, including, but not limited to, reference designs and materials relating to evaluation modules, (collectively, "TI Resources") are intended to assist designers who are developing applications that incorporate TI products; by downloading, accessing or using TI Resources in any way, Designer (individually or, if Designer is acting on behalf of a company, Designer's company) agrees to use any particular TI Resource solely for this purpose and subject to the terms of this Notice.

TI's provision of TI Resources does not expand or otherwise alter TI's applicable published warranties or warranty disclaimers for TI products, and no additional obligations or liabilities arise from TI providing such TI Resources. TI reserves the right to make corrections, enhancements, improvements and other changes to its TI Resources. TI has not conducted any testing other than that specifically described in the published documentation for a particular TI Resource.

Designer is authorized to use, copy and modify any individual TI Resource only in connection with the development of applications that include the TI product(s) identified in such TI Resource. NO OTHER LICENSE, EXPRESS OR IMPLIED, BY ESTOPPEL OR OTHERWISE TO ANY OTHER TI INTELLECTUAL PROPERTY RIGHT, AND NO LICENSE TO ANY TECHNOLOGY OR INTELLECTUAL PROPERTY RIGHT OF TI OR ANY THIRD PARTY IS GRANTED HEREIN, including but not limited to any patent right, copyright, mask work right, or other intellectual property right relating to any combination, machine, or process in which TI products or services are used. Information regarding or referencing third-party products or services does not constitute a license to use such products or services, or a warranty or endorsement thereof. Use of TI Resources may require a license from a third party under the patents or other intellectual property of the third party, or a license from TI under the patents or other intellectual property of TI.

TI RESOURCES ARE PROVIDED "AS IS" AND WITH ALL FAULTS. TI DISCLAIMS ALL OTHER WARRANTIES OR REPRESENTATIONS, EXPRESS OR IMPLIED, REGARDING RESOURCES OR USE THEREOF, INCLUDING BUT NOT LIMITED TO ACCURACY OR COMPLETENESS, TITLE, ANY EPIDEMIC FAILURE WARRANTY AND ANY IMPLIED WARRANTIES OF MERCHANTABILITY, FITNESS FOR A PARTICULAR PURPOSE, AND NON-INFRINGEMENT OF ANY THIRD PARTY INTELLECTUAL PROPERTY RIGHTS. TI SHALL NOT BE LIABLE FOR AND SHALL NOT DEFEND OR INDEMNIFY DESIGNER AGAINST ANY CLAIM, INCLUDING BUT NOT LIMITED TO ANY INFRINGEMENT CLAIM THAT RELATES TO OR IS BASED ON ANY COMBINATION OF PRODUCTS EVEN IF DESCRIBED IN TI RESOURCES OR OTHERWISE. IN NO EVENT SHALL TI BE LIABLE FOR ANY ACTUAL, DIRECT, SPECIAL, COLLATERAL, INDIRECT, PUNITIVE, INCIDENTAL, CONSEQUENTIAL OR EXEMPLARY DAMAGES IN CONNECTION WITH OR ARISING OUT OF TI RESOURCES OR USE THEREOF, AND REGARDLESS OF WHETHER TI HAS BEEN ADVISED OF THE POSSIBILITY OF SUCH DAMAGES.

Unless TI has explicitly designated an individual product as meeting the requirements of a particular industry standard (e.g., ISO/TS 16949 and ISO 26262), TI is not responsible for any failure to meet such industry standard requirements.

Where TI specifically promotes products as facilitating functional safety or as compliant with industry functional safety standards, such products are intended to help enable customers to design and create their own applications that meet applicable functional safety standards and requirements. Using products in an application does not by itself establish any safety features in the application. Designers must ensure compliance with safety-related requirements and standards applicable to their applications. Designer may not use any TI products in life-critical medical equipment unless authorized officers of the parties have executed a special contract specifically governing such use. Life-critical medical equipment is medical equipment where failure of such equipment would cause serious bodily injury or death (e.g., life support, pacemakers, defibrillators, heart pumps, neurostimulators, and implantables). Such equipment includes, without limitation, all medical devices identified by the U.S. Food and Drug Administration as Class III devices and equivalent classifications outside the U.S.

TI may expressly designate certain products as completing a particular qualification (e.g., Q100, Military Grade, or Enhanced Product). Designers agree that it has the necessary expertise to select the product with the appropriate qualification designation for their applications and that proper product selection is at Designers' own risk. Designers are solely responsible for compliance with all legal and regulatory requirements in connection with such selection.

Designer will fully indemnify TI and its representatives against any damages, costs, losses, and/or liabilities arising out of Designer's non-compliance with the terms and provisions of this Notice.

Mouser Electronics

Authorized Distributor

Click to View Pricing, Inventory, Delivery & Lifecycle Information:

Texas Instruments:

[LM2941LD](#) [LM2941LD/NOPB](#) [LM2941LDX](#) [LM2941LDX/NOPB](#) [LM2941S](#) [LM2941S/NOPB](#) [LM2941SX](#)

[LM2941SX/NOPB](#) [LM2941T](#) [LM2941T/LB03](#) [LM2941T/LB04](#) [LM2941T/LB08](#) [LM2941T/LF03](#) [LM2941T/NOPB](#)

[LM2941GW-QMLV](#) [LM2941GWRLQMLV](#) [LM2941 MDE](#) [5962-9166703VYA](#) [5962R9166704VYA](#)