

RTEN-2 SERIES

Multipurpose Low-leakage Current Three-Phase Filter with Many Current Variations



FEATURES

- Low-leakage current type.
- 6 to 300A wide range lineup.
- Small due to L1, light and thin.
- Low-profile design.
- Self-tightening screws and an open/close type cover make wiring work easier.
- Terminal block cover included for safety.

SAFETY STANDARDS

- UL1283 (Up to 150A)
- EN60939-1/-2 (ENEC14)

PRODUCT IDENTIFICATION

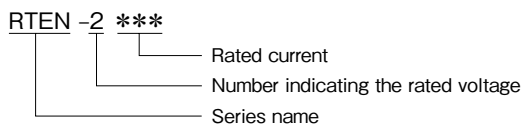

CONFORMITY TO RoHS Directive

CIRCUIT DIAGRAM

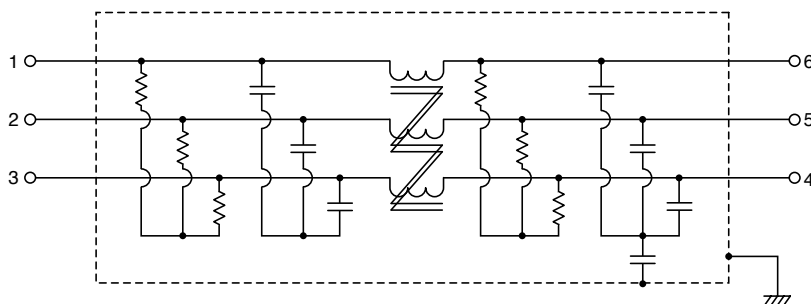

ELECTRICAL CHARACTERISTICS

Part No.	Rated voltage (AC/DC)	Rated current (AC/DC)	Withstand voltage	Insulation resistance	Leakage current	Operating temperature range	With derating over	DC resistance (mΩ)	Attenuation frequency range (MHz)			Weight (kg)
									Common mode		Differential mode	
									at 25dB	at 20dB	at 25dB	
RTEN-2006	250V	6A	AC.2000V 60s [line - earth]	100MΩ min. [DC500V/ 1min]	1mA max. [250V/60Hz]	-25 to +85°C	50°C	145max.	0.2 to 10	-	0.2 to 30	0.36
RTEN-2010		10A						60max.	0.3 to 10	-	0.2 to 30	0.36
RTEN-2020		20A						25max.	0.4 to 10	-	0.2 to 30	0.56
RTEN-2030		30A						13max.	-	1 to 10	0.2 to 30	0.56
RTEN-2040		40A						10max.	-	1 to 10	0.2 to 30	1.10
RTEN-2050		50A						7max.	-	2 to 10	0.2 to 30	1.10
RTEN-2060		60A						5max.	-	3 to 10	0.2 to 30	1.10
RTEN-2080		80A						5max.	-	1 to 10	0.2 to 5	3.90
RTEN-2100		100A						4max.	-	1 to 10	0.2 to 5	4.20
RTEN-2150		150A						3max.	-	2 to 9	0.2 to 5	6.50
RTEN-2200		200A						2max.	-	3 to 9	0.2 to 5	9.20
RTEN-2250		250A						1.5max.	-	3 to 9	0.2 to 5	8.70
RTEN-2300		300A						1max.	-	4 to 7	0.2 to 5	8.30

DERATING GRAPH

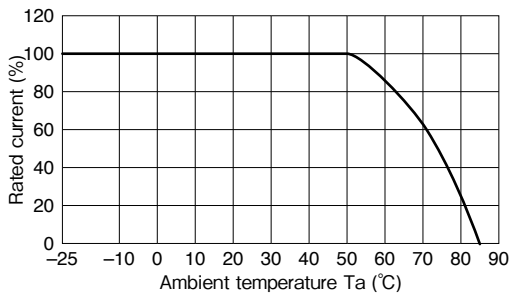

MECHANICAL

RTEN-2006/2010

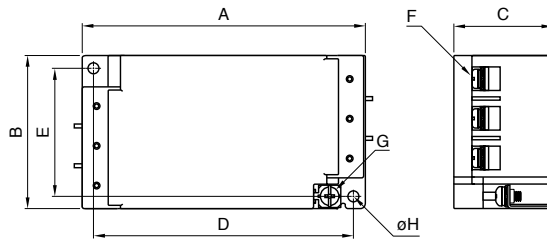

RTEN-2020/2030/2040/2050/2060

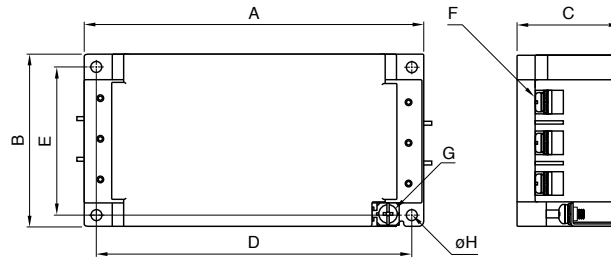

Dimensions in mm

Part No.	A	B	C	D	E	F	G	ϕH	Recommended clamping torque
RTEN-2006	120	63	42	110	53	M4	M4	4.5	M4 : 1.27N · m M5 : 2.5N · m
RTEN-2010									
RTEN-2020	140	70	42	130	60	M4	M4		
RTEN-2030									
RTEN-2040	170	90	54	160	80	M5	M4	4.5	
RTEN-2050									
RTEN-2060									

RTEN-2080/2100/2150

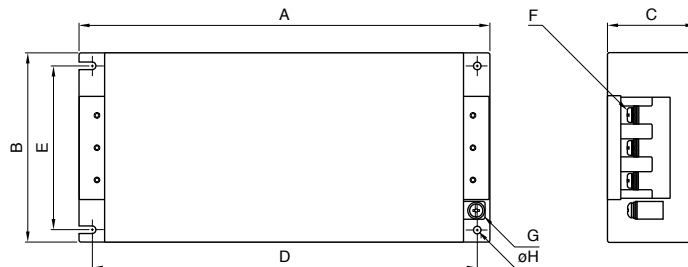

RTEN-2200/2250/2300

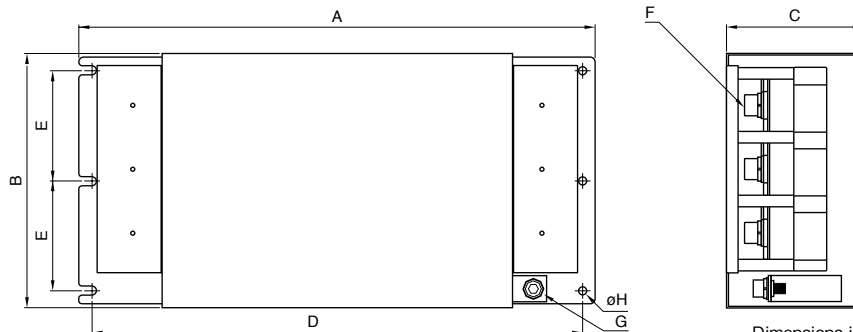

Dimensions in mm

Part No.	A	B	C	D	E	F	G	ϕH	Recommended clamping torque
RTEN-2080	267	161	85	247	135	M8	M6	6.5	M6 : 4.8N · m M8 : 7.64N · m
RTEN-2100									
RTEN-2150	290	190	88	270	164	M8	M6	6.5	
RTEN-2200									
RTEN-2250									
RTEN-2300	390	195	103	370	84.5	M10	M8	6.5	M10 : 11.8N · m

■ ATTENUATION vs. FREQUENCY CHARACTERISTICS

RTEN-2006

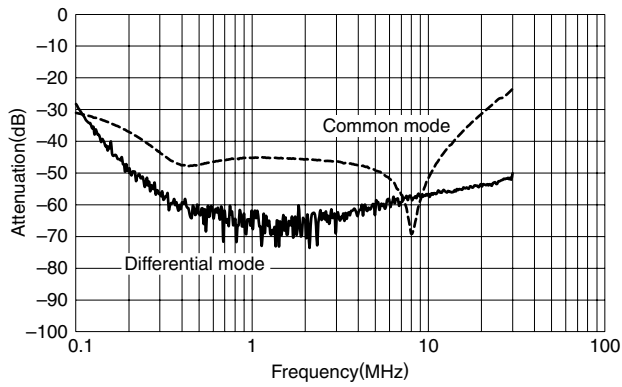

RTEN-2010

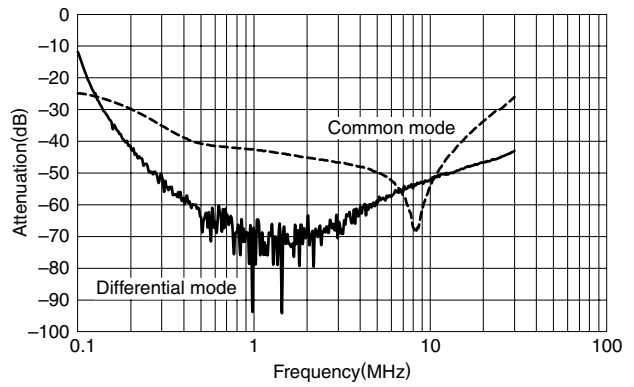

RTEN-2020

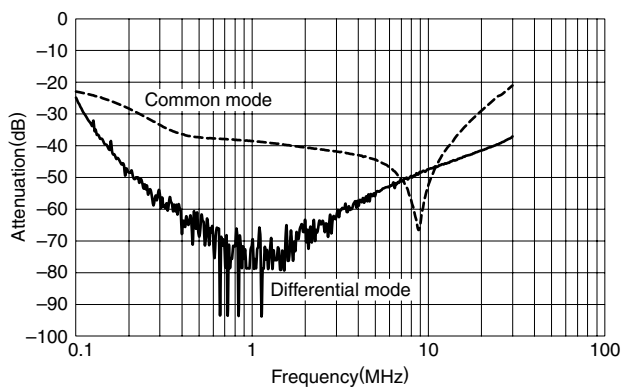

RTEN-2030

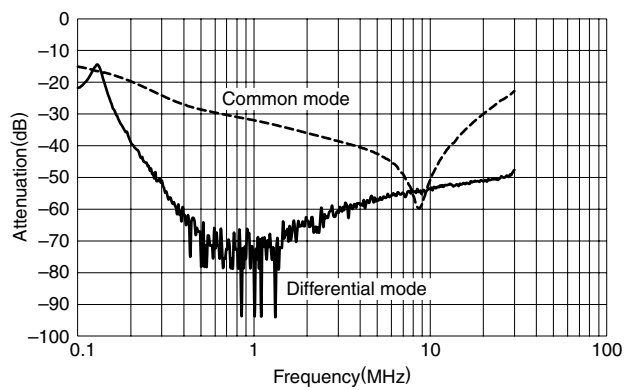

RTEN-2040

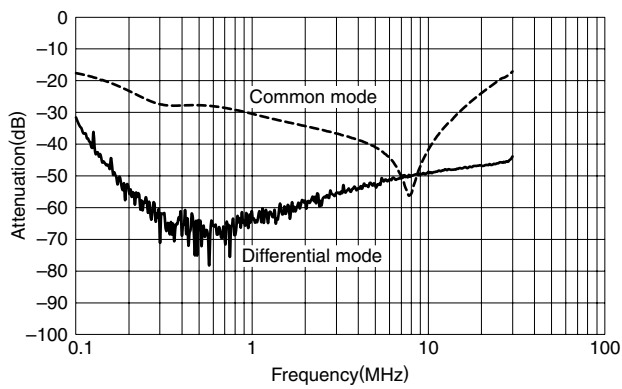

RTEN-2050

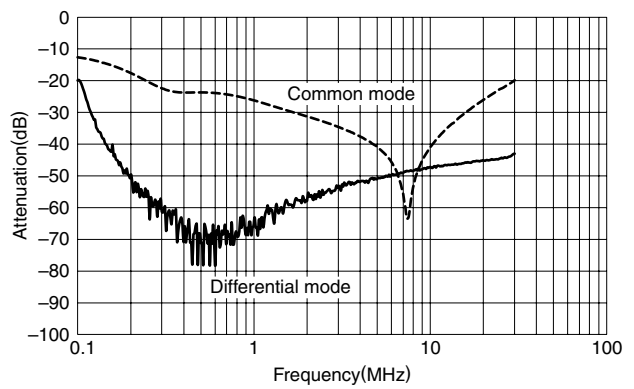

RTEN-2060

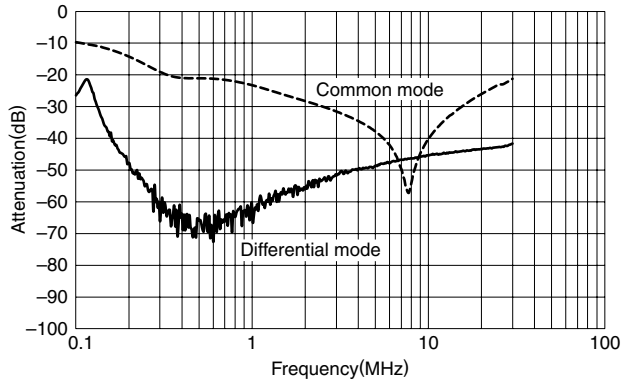

RTEN-2080

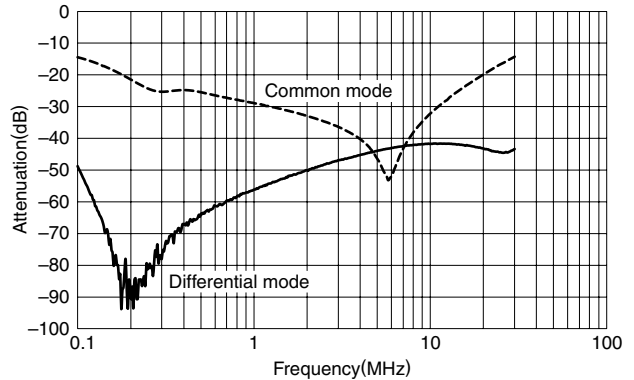

RTEN-2100

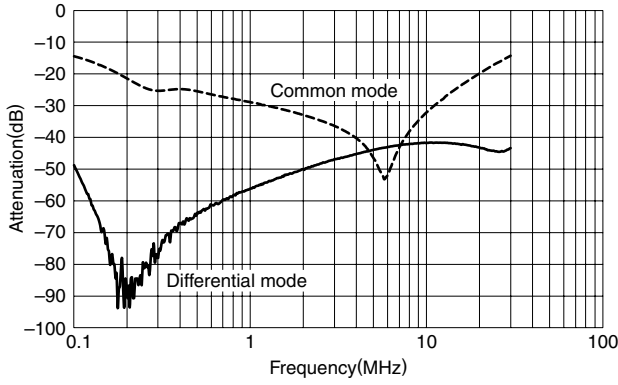

RTEN-2150

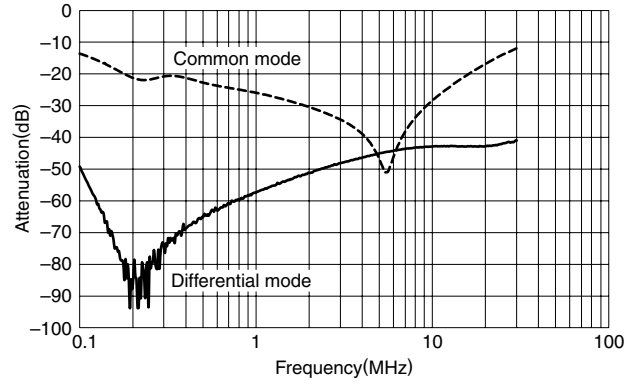

RTEN-2200

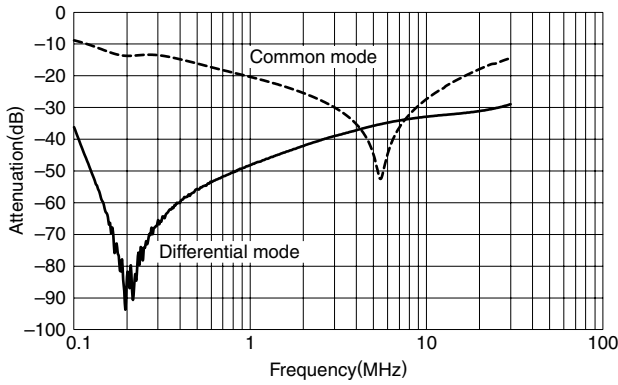

RTEN-2250

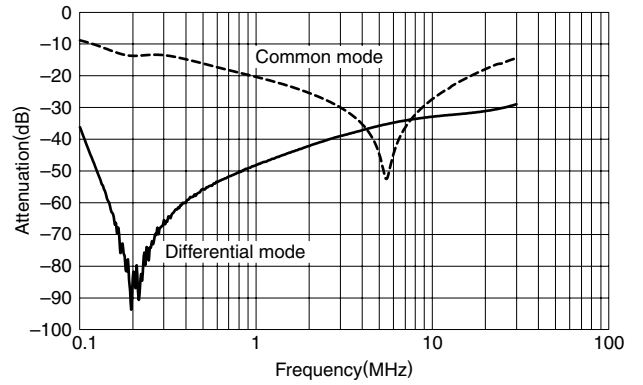

RTEN-2300

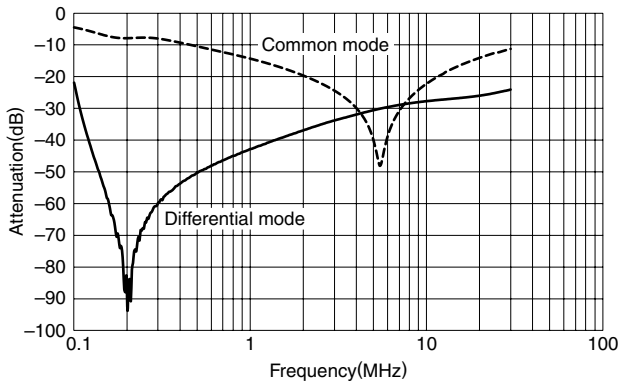

Mouser Electronics

Authorized Distributor

Click to View Pricing, Inventory, Delivery & Lifecycle Information:

[TDK-Lambda:](#)

[RTEN-2010](#) [RTEN-2040](#)