

6

5

4

3

2

1

APPROVED: \_\_\_\_\_

DATE: \_\_\_\_\_ TITLE: \_\_\_\_\_

Rev	AWO #	Description	Date	Appr
-		RELEASED	6/8/22	
A		ADDED PACKING	6/16/22	JJ/JL

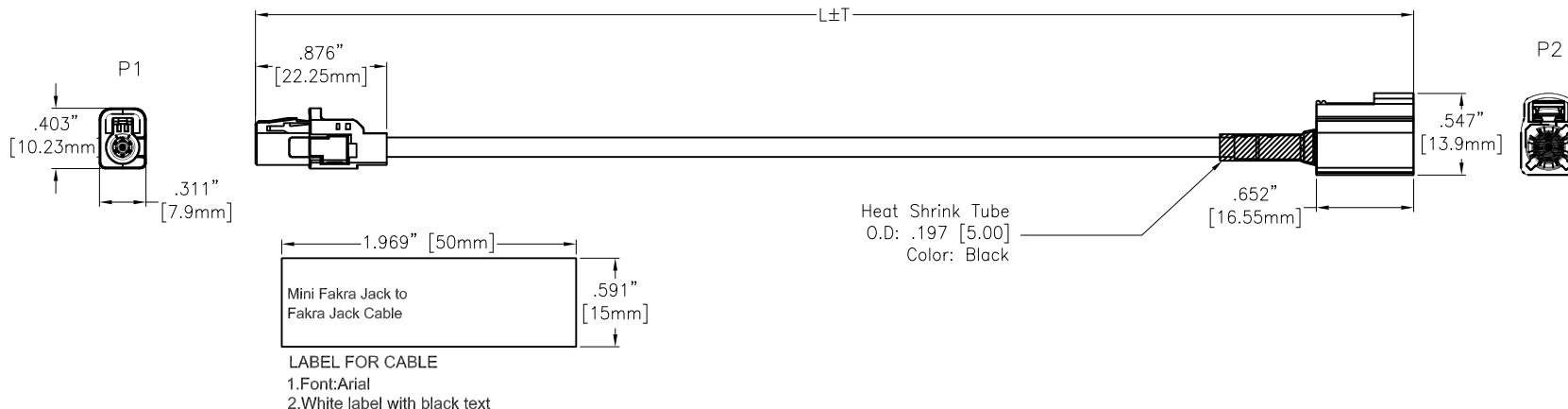

**SPECIFICATIONS:**

**Connector:**

P1= Mini FAKRA Code see Page 2, Jack, Straight, Type A, 30u" Gold Plated, UL94-V0

P2= FAKRA Code see Page 3, Jack, Straight, 30u" Gold Plated, UL94-V0

**Cable:**

Cable Coaxial+AL+Braid, O.D: .130" [3.3mm], Jacket Color: Black

**Electrical:**

Impedance: 50 Ohm

Temperature Rating:

-40°C to +105°C

**Electrical Test:**

All Assemblies must be 100% Tested for Shorts, Open, Continuity, and Physical Appearance.

**Environmental:**

Lead free, RoHS compliant



ADAM P/N	L+T
CA-AM01XJ-1FJX-1M	39.370"±1.181" [1000±30mm]
CA-AM01XJ-1FJX-1.9M	74.803"±1.181" [1900±30mm]
CA-AM01XJ-1FJX-2.5M	98.425"±1.969" [2500±50mm]

UNLESS OTHERWISE SPECIFIED ALL DIMENSIONS ARE INCHES [MM]. TOLERANCES: EXCEPT AS NOTED

INCHES		HOLES	
.X	±.10	Ø.X	±.10
.XX	±.020	Ø.XX	±.015
.XXX	±.015	Ø.XXX	±.010



909 Rahway Avenue,  
Union, NJ 07083  
Phone: 908-687-5000  
Fax: 908-687-5710

DRAWN	WX	6/8/22
CHECKED	JL	6/8/22
APPROVED		

TITLE  
MINI FAKRA JACK A TYPE STRAIGHT  
TO FAKRA JACK STRAIGHT, OD 3.3 CABLE

THIS DRAWING CONTAINS INFORMATION THAT IS PROPRIETARY AND SHOULD NOT BE USED WITHOUT PRIOR WRITTEN PERMISSION FROM ADAM TECH

SIZE	PART NO.	REV.
X	CA-AM01XJ-1FJX-XM	A
REF: S00013T	SCALE: NTS	SHEET 1 OF 4

6

5

4

3

2

1

6

5

4

3

2

1

APPROVED: \_\_\_\_\_

DATE: \_\_\_\_\_ TITLE: \_\_\_\_\_

Rev	AWO #	Description	Date	Appr
-----	-------	-------------	------	------

SEE SHT 1 OF 4 FOR REVISION

Mini Fakra A CA-AM01XJ-1FJX-XM

CODING A	CODING B	CODING C	CODING D	CODING E	CODING F	CODING G	CODING H
Black	White	Blue	Claret Violet	Green	Brown	Grey	Light Pink
CODING J	CODING K	CODING Z	All Coding				
Belge	Curry	Water Blue					

UNLESS OTHERWISE SPECIFIED ALL DIMENSIONS ARE INCHES [MM]. TOLERANCES: EXCEPT AS NOTED

INCHES		HOLES	
.X	±.10	Ø.X	±.10
.XX	±.020	Ø.XX	±.015
.XXX	±.015	Ø.XXX	±.010

**ADAM TECH**

909 Rahway Avenue,  
Union, NJ 07083  
Phone: 908-687-5000  
Fax: 908-687-5710

DRAWN	WX	6/8/22
CHECKED	JL	6/8/22
APPROVED		

TITLE  
MINI FAKRA JACK A TYPE STRAIGHT  
TO FAKRA JACK STRAIGHT, OD 3.3 CABLE

THIS DRAWING CONTAINS INFORMATION THAT IS PROPRIETARY AND SHOULD NOT BE USED WITHOUT PRIOR WRITTEN PERMISSION FROM ADAM TECH

SIZE X	PART NO. CA-AM01XJ-1FJX-XM	REV. A
REF: S00013T	SCALE: NTS	SHEET 2 OF 4

6

5

4

3

2

1

6

5

4

3

2

1

APPROVED: \_\_\_\_\_

DATE: \_\_\_\_\_ TITLE: \_\_\_\_\_

Rev	AWO #	Description	Date	Appr
-----	-------	-------------	------	------

SEE SHT 1 OF 4 FOR REVISION

Fakra CA-AM01XJ-1FJX-XM

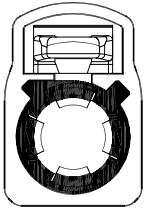
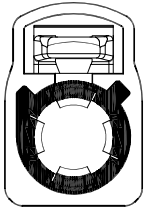
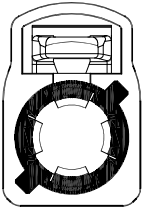
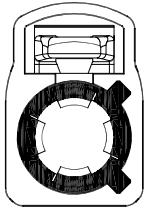
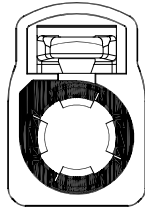
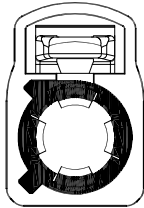
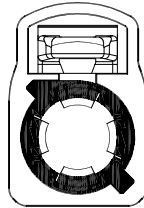
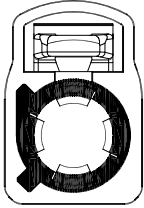
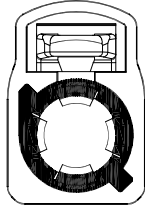
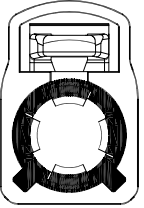
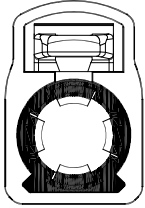
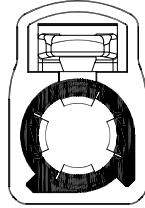
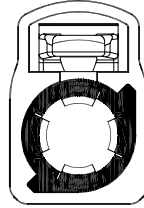
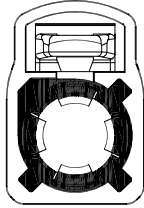
Coding	A	B	C	D	E	F	G
Plug							
Color	Black	White	Blue	Bordeaux Violet	Green	Brown	Grey
Coding	H	I	K	L	M	N	Z
Plug							
Color	Violet	Beige	Curry	Carmine Red	Pastel Orange	Pastel Green	Water Blue

UNLESS OTHERWISE SPECIFIED ALL DIMENSIONS ARE INCHES [MM]. TOLERANCES: EXCEPT AS NOTED

INCHES		HOLES	
.X	± .10	∅.X	± .10
.XX	± .020	∅.XX	± .015
.XXX	± .015	∅.XXX	± .010

**ADAM TECH**

909 Rahway Avenue,  
Union, NJ 07083  
Phone: 908-687-5000  
Fax: 908-687-5710

DRAWN	WX	6/8/22
CHECKED	JL	6/8/22
APPROVED		

TITLE  
MINI FAKRA JACK A TYPE STRAIGHT  
TO FAKRA JACK STRAIGHT, OD 3.3 CABLE

THIS DRAWING CONTAINS INFORMATION THAT IS PROPRIETARY AND SHOULD NOT BE USED WITHOUT PRIOR WRITTEN PERMISSION FROM ADAM TECH

SIZE X	PART NO. CA-AM01XJ-1FJX-XM	REV. A
REF: S00013T	SCALE: NTS	SHEET 3 OF 4

6

5

4

3

2

1

6

5

4

3

2

1

APPROVED: \_\_\_\_\_

DATE: \_\_\_\_\_ TITLE: \_\_\_\_\_

Rev	AWO #	Description	Date	Appr
-----	-------	-------------	------	------

SEE SHT 1 OF 4 FOR REVISION

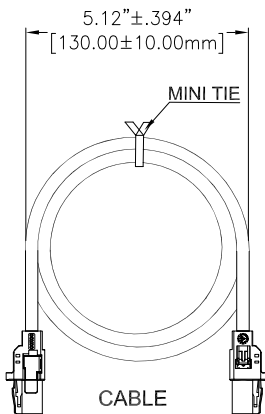

+

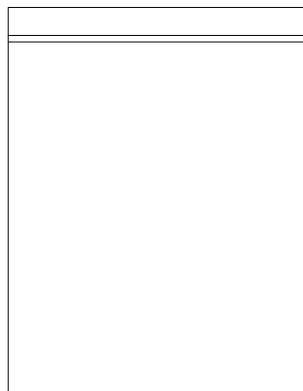

240(L)\*170(W) ZIP BAG

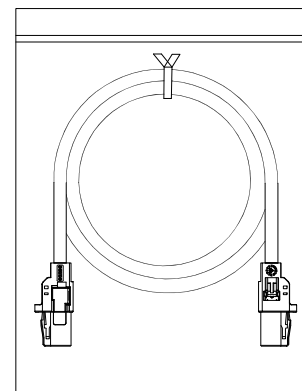

1PC/ZIP BAG

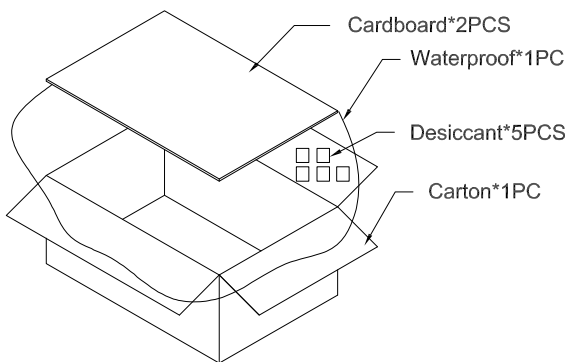

16"(L)\*13"(W)\*6.5"(H)

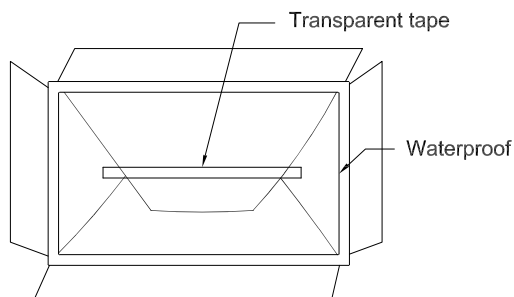

(After the installed Product, carton sealing tape should be transparent)

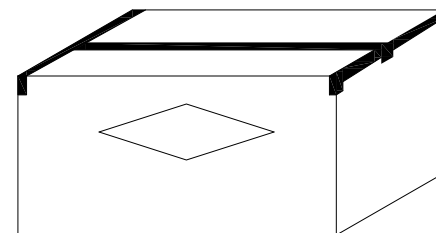

UNLESS OTHERWISE SPECIFIED ALL DIMENSIONS ARE INCHES [MM]. TOLERANCES: EXCEPT AS NOTED

INCHES		HOLES	
.X	± .10	Ø.X	± .10
.XX	± .020	Ø.XX	± .015
.XXX	± .015	Ø.XXX	± .010

**ADAM TECH**

909 Rahway Avenue,  
Union, NJ 07083  
Phone: 908-687-5000  
Fax: 908-687-5710

DRAWN	WX	6/8/22
CHECKED	JL	6/8/22
APPROVED		

TITLE  
MINI FAKRA JACK A TYPE STRAIGHT  
TO FAKRA JACK STRAIGHT , OD 3.3 CABLE

THIS DRAWING CONTAINS INFORMATION THAT IS PROPRIETARY AND SHOULD NOT BE USED WITHOUT PRIOR WRITTEN PERMISSION FROM ADAM TECH

SIZE X	PART NO. CA-AM01XJ-1FJX-XM	REV. A
REF: S00013T	SCALE: NTS	SHEET 4 OF 4

6

5

4

3

2

1

# Mouser Electronics

Authorized Distributor

Click to View Pricing, Inventory, Delivery & Lifecycle Information:

[Adam Tech:](#)

[CA-AM01ZJ-1FJZ-1M](#)