



TAOGLAS®

Datasheet

Neptune Series

Part No:
XAHP.30.A.1L21

Description

Multi-Mount, Multi-Band Active GNSS Marine Antenna with BNC Connector

Features:

- Embedded Dual Patch, Dual Feed 4-Pin Assembly
- Covering L1,L2,L5 and L-Band GNSS Frequencies
- Low Axial Ratio
- Pole and Deck Mounting Options
- Robust, IP67 Rated Enclosure
- Cable: 5m of RG174
- Connector: BNC (F)
- Dimensions: Ø113 x 80mm
- RoHS & Reach Compliant

1.	Introduction	3
2.	Specification	4
3.	Mechanical Drawing	7
4.	Installation Guide	8
5.	Packaging	10
6.	Antenna Characteristics	12
7.	LNA Characteristics	20
8.	Field Test Results	24
9.	Radiation Patterns	25
<hr/>		
	Changelog	34

Taoglas makes no warranties based on the accuracy or completeness of the contents of this document and reserves the right to make changes to specifications and product descriptions at any time without notice. Taoglas reserves all rights to this document and the information contained herein. Reproduction, use or disclosure to third parties without express permission is strictly prohibited.



1. Introduction



Compact, Multiband GNSS Antenna for High Precision, Accurate Positioning Marine Applications

The Taoglas Neptune XAHP.30 is an external active multi-band GNSS antenna engineered for high-performance marine applications that demand enhanced signal filtering combined with multipath rejection. This antenna is designed to include the full sweep of GNSS bands and frequencies including GPS (L1,L2,L5), GLONASS (G1,G2,G3), Galileo (E1, E5a, E5b,) BeiDou (B1C, B1I, B2a, B2b), IRNSS (L5), QZSS (L1,L2C,L5), SBAS and L-Band (1542MHz). Including the option for all these GNSS systems ensures quick time to first fix, enhanced navigational accuracy, and the reliability you expect from a Taoglas product.

The dual-feed, dual-patch is designed for superb axial ratio, and the active electronics integrate low-loss filters and front-end SAW filters that help eliminate nearby out-of-band signals. High performance is achieved with a Gain figure of 26.8dB across bandwidth. The product is tested with a voltage rating range of 1.8 to 5.5 V for enhanced safety.

Typical Applications:

- Marine, Boats and Water Leisure Activities
- Military Vehicle Tracking & Asset Tracking
- Fleet Telematics and Navigation
- Surveying and Mapping Systems

Installation:

The Neptune antenna was designed with a ruggedised IP67-rated enclosure and mount to cope with the most demanding marine environments and weather conditions. The white ASA material is lightweight and strong and the domed enclosure prevents water ingress and birds from resting on the antenna. The XAHP.30 allows for both pole and deck mounting options, and installation is simple. The antenna is designed to operate in conditions from -40C and +85C without any effects on performance. The antenna has a BNC(F) connector as standard and comes with a 5m RG-174 cable with BNC(M) connectors to connect you to your navigational equipment. Customised cable can be configured from the Taoglas Cable Builder if you require an alternative.

For more information on the Neptune XAHP.30 or to request samples, contact your local Taoglas customer services team.

2. Specification

GNSS Frequency Bands					
GPS	L1 1575.42 MHz	L2 1227.6 MHz	L5 1176.45 MHz		
	■	■	■		
GLONASS	G1 1602 MHz	G2 1248 MHz	G3 1207 MHz		
	■	■	■		
Galileo	E1 1575.24 MHz	E5a 1176.45 MHz	E5b 1201.5 MHz	E6 1278.75 MHz	
	■	■	■	□	
BeiDou	B1C 1575.42 MHz	B1I 1561 MHz	B2a 1176.45 MHz	B2b 1207.14 MHz	B3 1268.52 MHz
	■	■	■	■	□
L-Band	L-Band 1542 MHz				
	■				
QZSS (Regional)	L1 1575.42 MHz	L2C 1227.6 MHz	L5 1176.45 MHz	L6 1278.75e6	
	■	■	■	□	
IRNSS (Regional)	L5 1176.45 MHz				
	■				
SBAS	L1/E1/B1 1575.42 MHz	L5/B2a/E5a 1176.45 MHz	G1 1602 MHz	G2 1248 MHz	G3 1207 MHz
	■	■	■	■	■

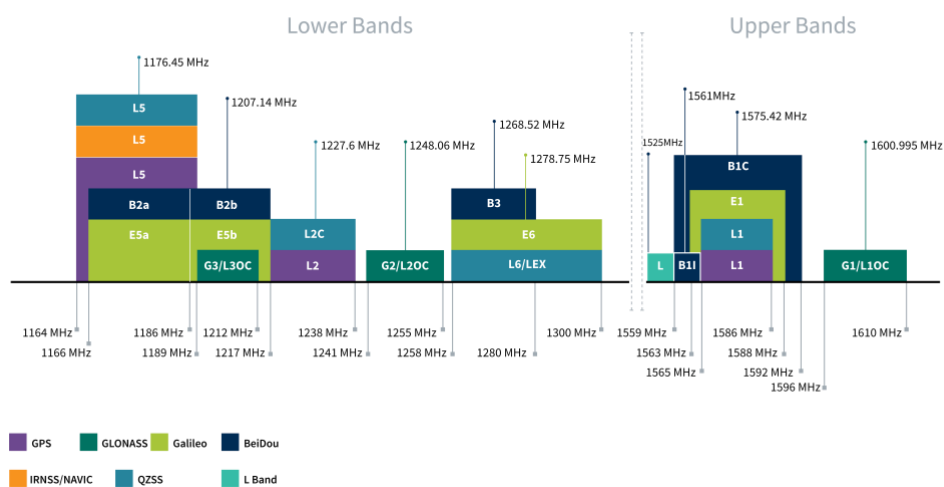

GNSS Bands and Constellations

GNSS Electrical								
Frequency (MHz)	1176.45	1201.55	1227.6	1248	1542	1561	1575.42	1603
VSWR (max.)	1:1	1:1	1:1	1:1	1:1	1:1	1:1	1:1
Passive Antenna Efficiency (%) (Without cable loss)	36	52	55	42	52	56	52	40
Passive Antenna Gain (dBi) (Without cable loss)	1.6	3.3	3.5	2.3	3.8	4.2	3.9	2.6
Axial Ratio (dB)	0.7	0.2	0.3	0.5	1.4	1.5	1.6	1.7
PCO (cm)	2.2	2.1	2.0	1.9	1.9	1.9	2.0	2.2
PCV (cm)	0.7	0.9	1.1	1.2	1.2	1.2	1.2	1.3
Group Delay (ns)	15.97	13.49	13.61	13.62	13.06	11.44	11.55	10.96
Polarization	RHCP							
Impedance	50 Ω							
Cable	RG174							
Connector	SMA(M)							
Tested in Free Space (See test set-up pictures in Section 6)								

LNA and Filter Electrical Properties								
Frequency (MHz)	1176.45	1201.55	1227.6	1248	1542	1561	1575.42	1603
Gain (dB)	25.5	26.8	26.7	26.4	26.8	26.8	26.6	26.2
Noise (dB)	3.2	2.8	2.7	2.7	1.7	1.6	1.6	1.5
Results shown are from Vin=1.8 to 5.5V								

Total Specification (Through Antenna, SAW Filter and LNA)								
Frequency (MHz)	1176.45	1201.55	1227.6	1248	1542	1561	1575.42	1603
Gain (dBi)	24.0	25.6	25.9	24.3	30.5	30.3	30.1	28.8
Total Specification Results tested on a pole								

Mechanical	
Dimensions	Ø113 x 62mm
Weight	223g
Enclosure Material	ASA
Connector	BNC (F)
Cable Assembly	5m of RG174 with BNC (M) to BNC (M)

Environmental	
Waterproof Rating	IP67
Temperature Range	-40°C to 85°C
Relative Humidity	65°C, 95%RH for 96 hours
RoHs & REACH Compliant	Yes

3. Mechanical Drawing

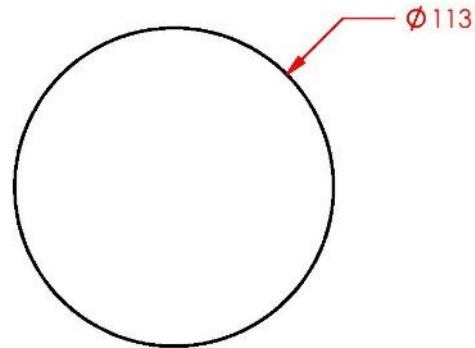

PLAN VIEW

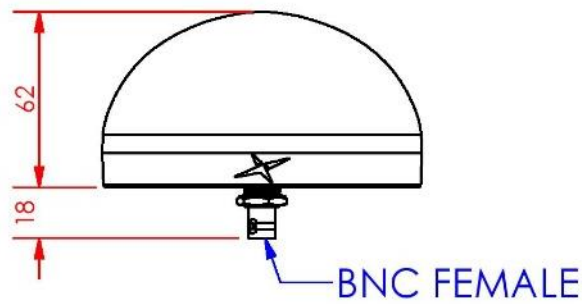

DECK MOUNT CONFIGURATION
FRONT ELEVATION VIEW

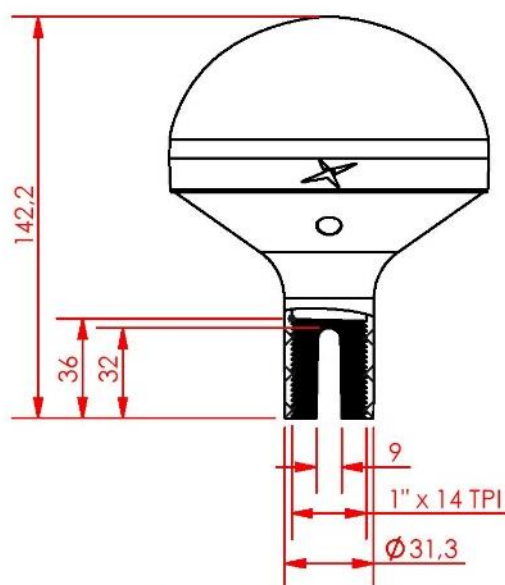

POLE MOUNT CONFIGURATION
FRONT ELEVATION VIEW

4. Installation Guide

4.1 What's in the box

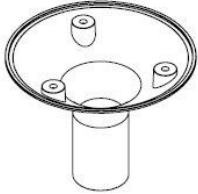

MARINE ANTENNA POLE MOUNT



BNC CONNECTOR TO CABLE (5 m) TO BNC CONNECTOR

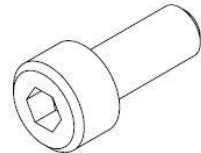

M4 x 10 FULL THREAD SKT HD CAP SCREW

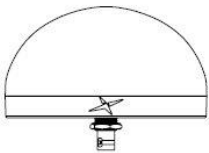

MARINE ANTENNA

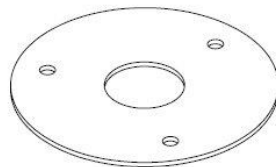

DECK GASKET





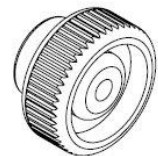

THREADED ROD M4

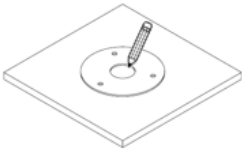
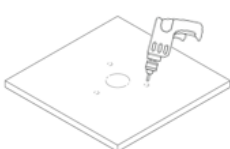

THROUGH HOLE KNOB M4

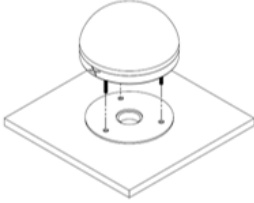
4.2 Deck Mount

<p>Step 1</p>  <p>Place the Gasket onto the deck to mark the positions of the holes that need to be drilled.</p>	<p>Step 2</p>  <p>Remove the Gasket and drill the marked holes.</p>	<p>Step 3</p>  <p>Place the Gasket back onto the deck and line it up with the drilled holes.</p>
<p>Step 4</p>  <p>Insert the M4 Threaded Rods into the base of the Marine Antenna.</p> <p><i>Optional:</i> Attach one end of the 5m long BNC(M) connector cable to the BNC(F) connector on the base of the antenna.</p>	<p>Step 5</p>  <p>Place the antenna on top of the Gasket, ensuring that the Threaded Rods (and the 5m cable, if fitted in Step 4) pass through the drilled holes.</p>	<p>Step 6</p>  <p>From the underside of the deck, clamp the antenna into place by fully threading home the M4 Knobs. Attach one end of the 5m long BNC(M) connector to the BNC(F) connector on the base of the antenna, if not done previously in Step 4.</p>

4.3 Pole Mount

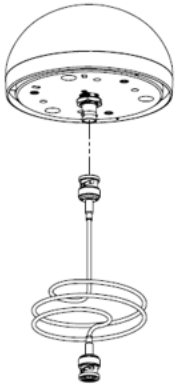
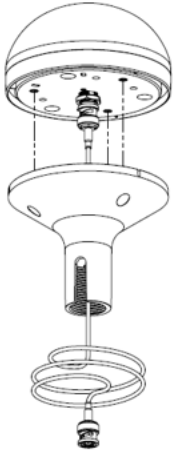
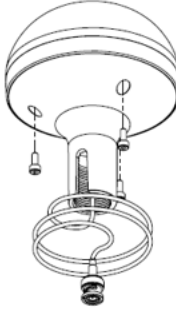
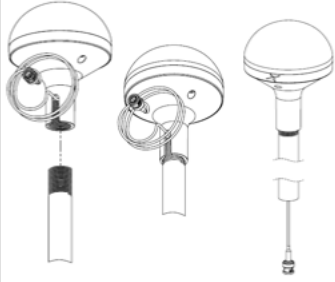
<p>Step 1</p>  <p>Attach one end of the 5m long BNC(M) connector cable to the BNC(F) connector on the base of the antenna.</p>	<p>Step 2</p>  <p>Pull the cable through the Pole Mount attachment and guide it into place on the bottom of the antenna.</p>	<p>Step 3</p>  <p>Connect the Pole Mount attachment using the M4 bolts.</p>	<p>Step 4</p>  <p>Pull the cable to the bottom of the slot on the Pole Mount attachment. Screw the attachment onto a 1" x 14 TPI mounting pole, taking care not to pinch the cable.</p> <p><i>Optional:</i> Feed the cable through the centre of the mounting pole.</p>
---	---	---	--

5. Packaging

3 pcs per Ziploc bag

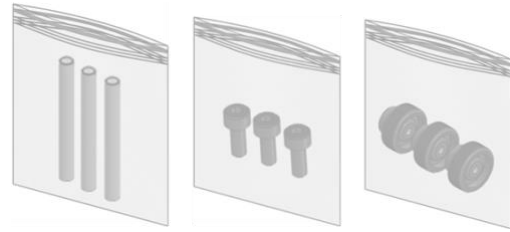

1 pcs per Ziploc bag



1 pcs per PE bag



1 Set/Box
 Box Dimensions : 248x147x135mm
 Weight : 0.58Kg

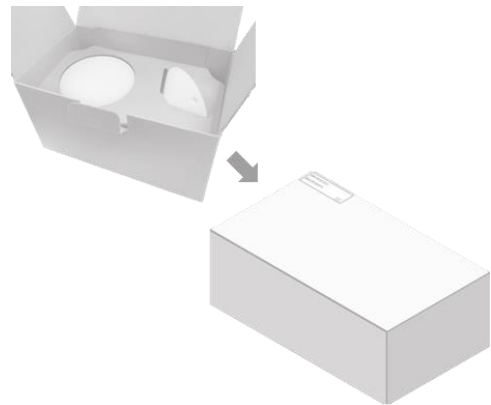

4 pcs per Carton
Carton Dimensions: 390x320x290mm
Weight: 3.1Kg



6. Antenna Characteristics

6.1 Test Setup

AUT



Vector Network Analyzer



VNA Test-Setup

6.2 Return Loss – Low-Band

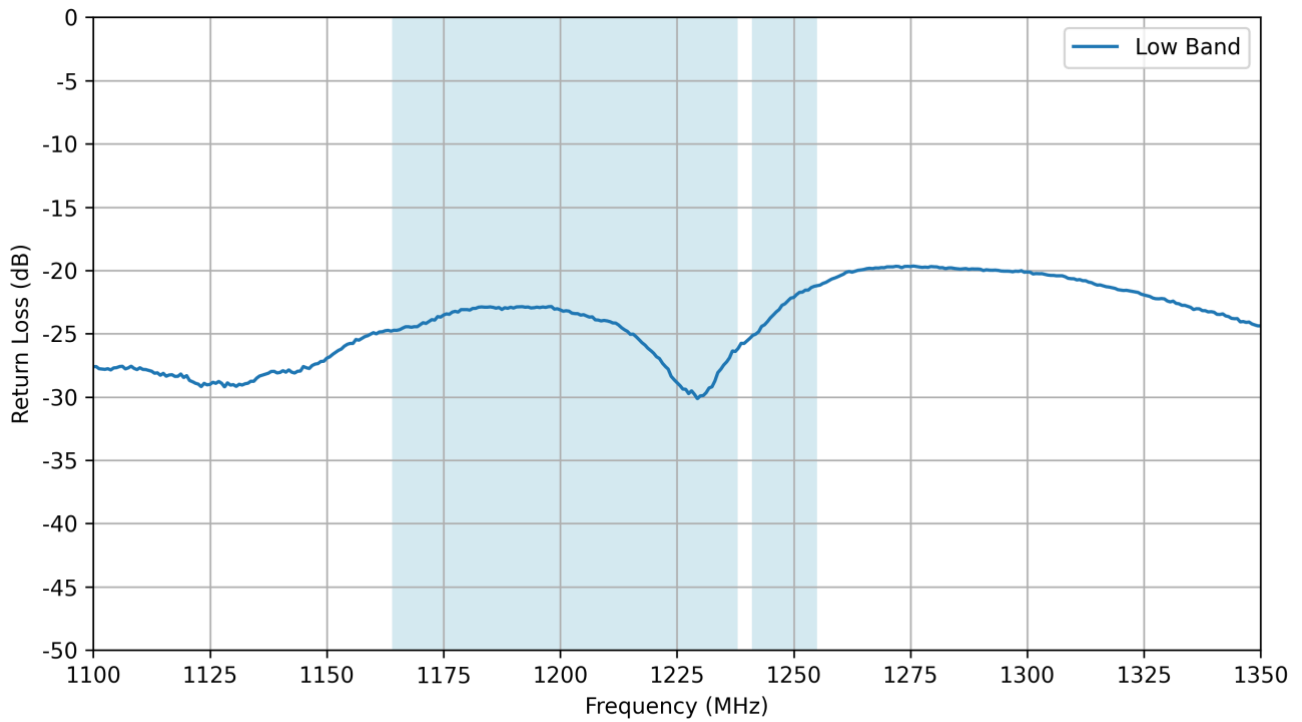

6.3 Return Loss – High-Band

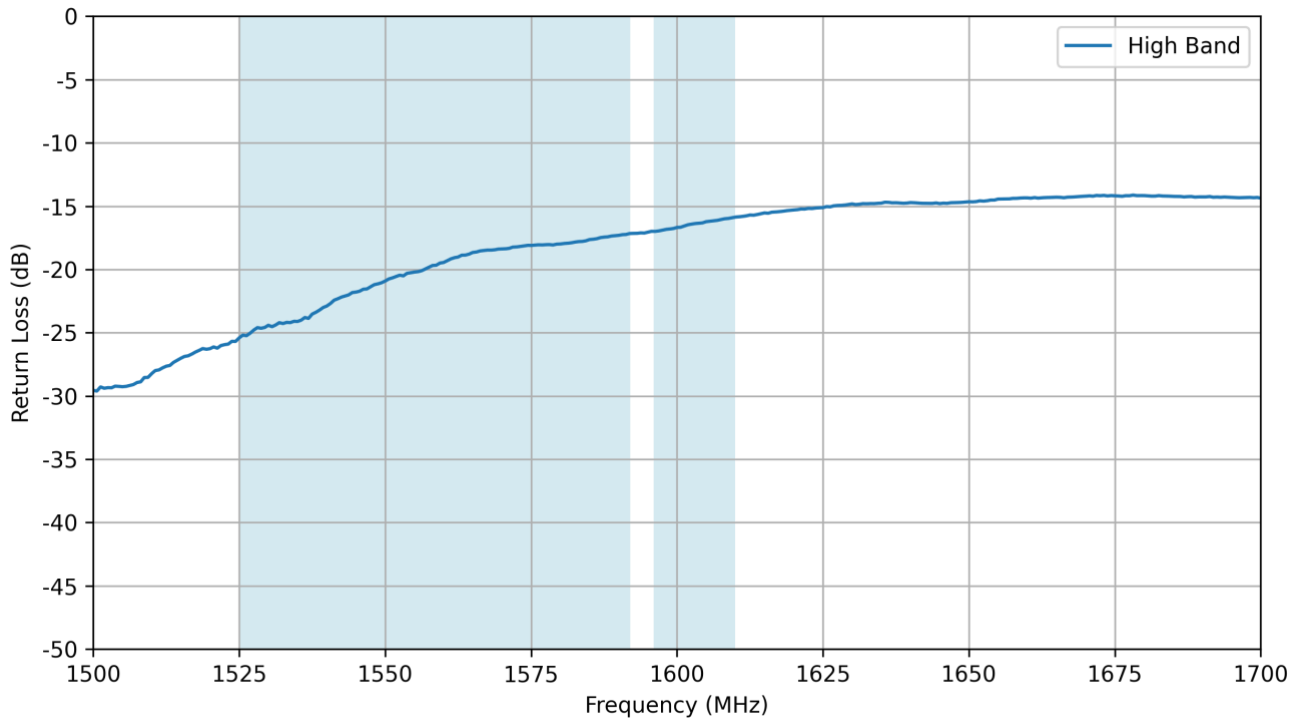

6.4 Efficiency – Low-Band

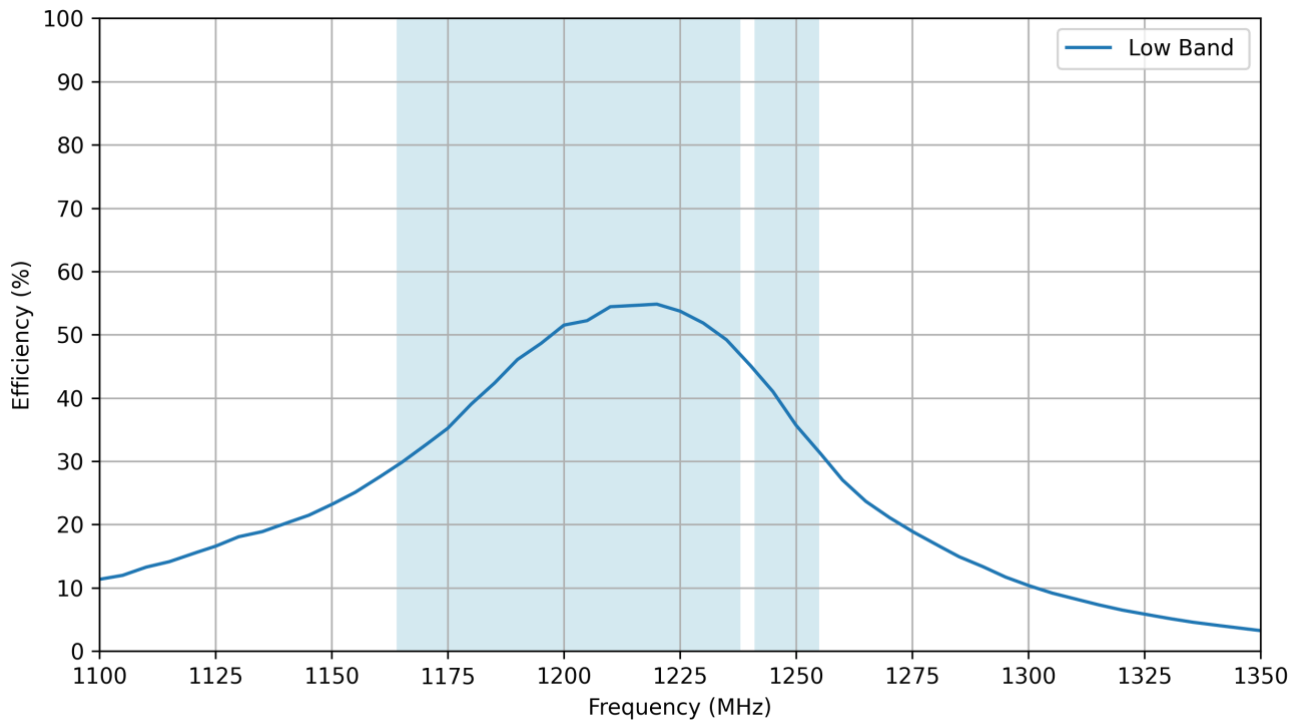

6.5 Efficiency – High-Band

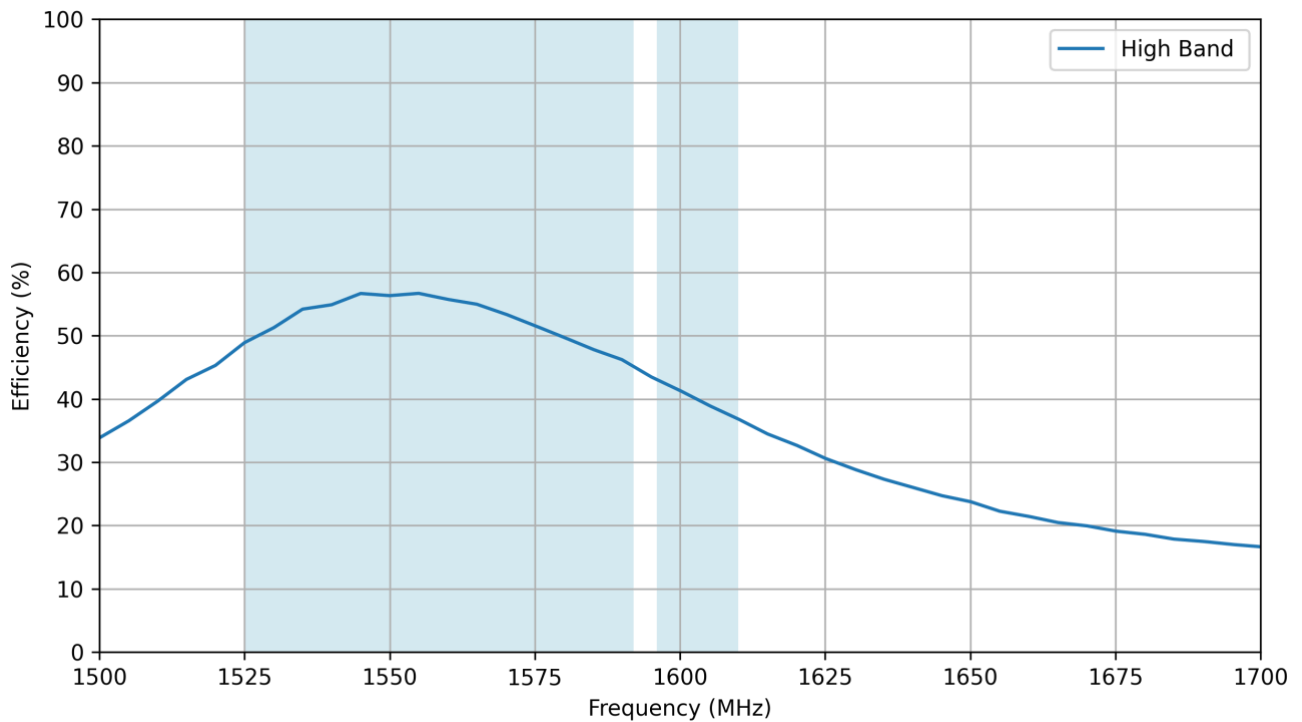

6.6 Average Gain – Low-Band

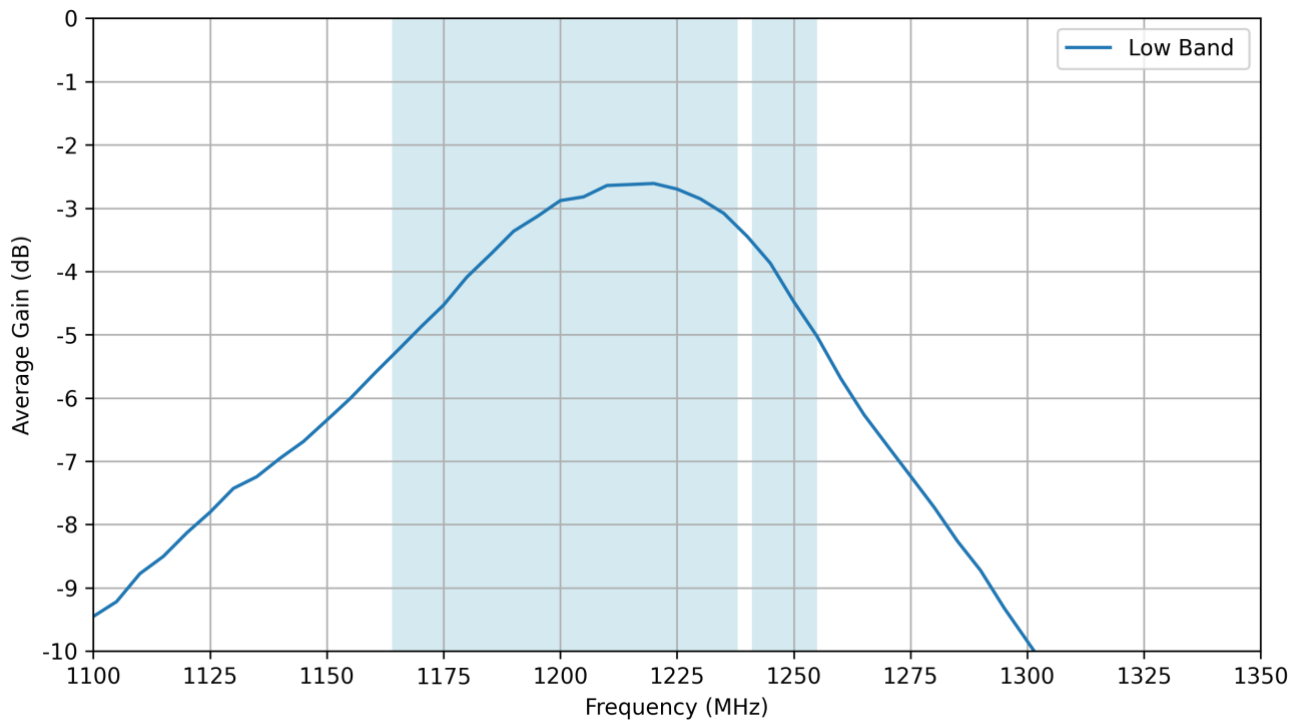

6.7 Average Gain – High-Band

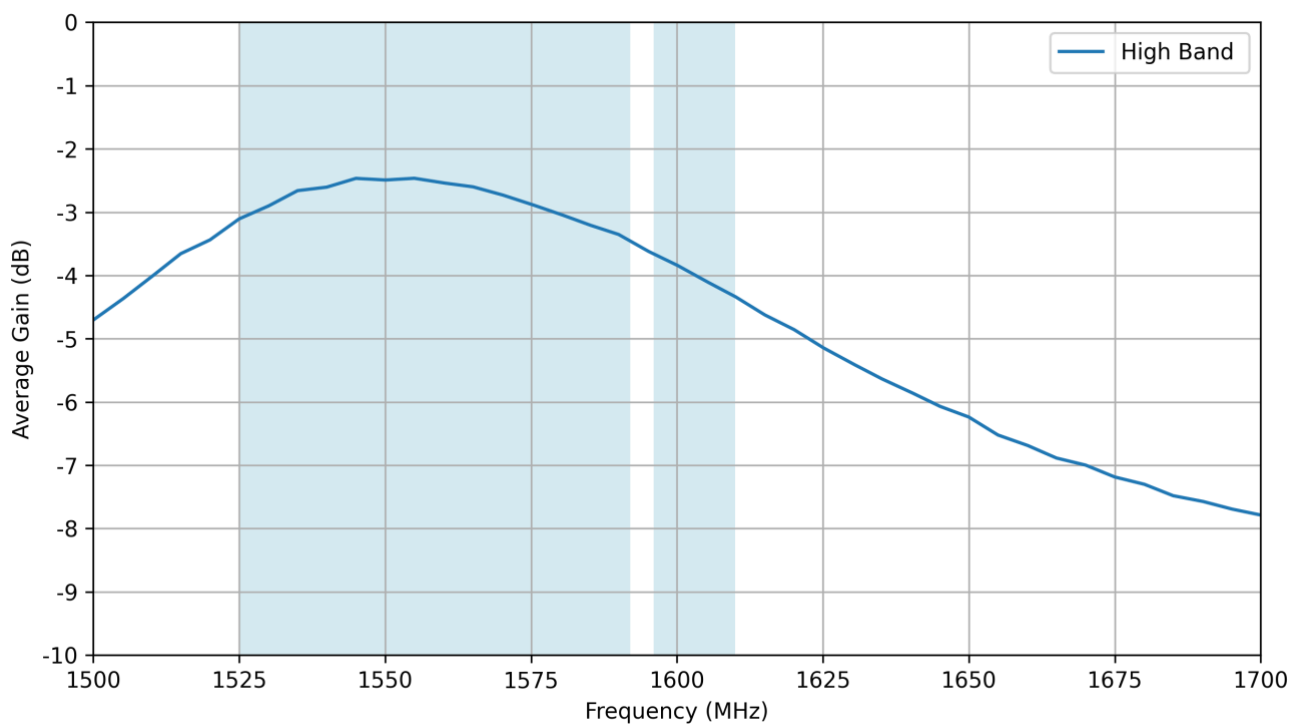

6.8 Peak Gain – Low-Band

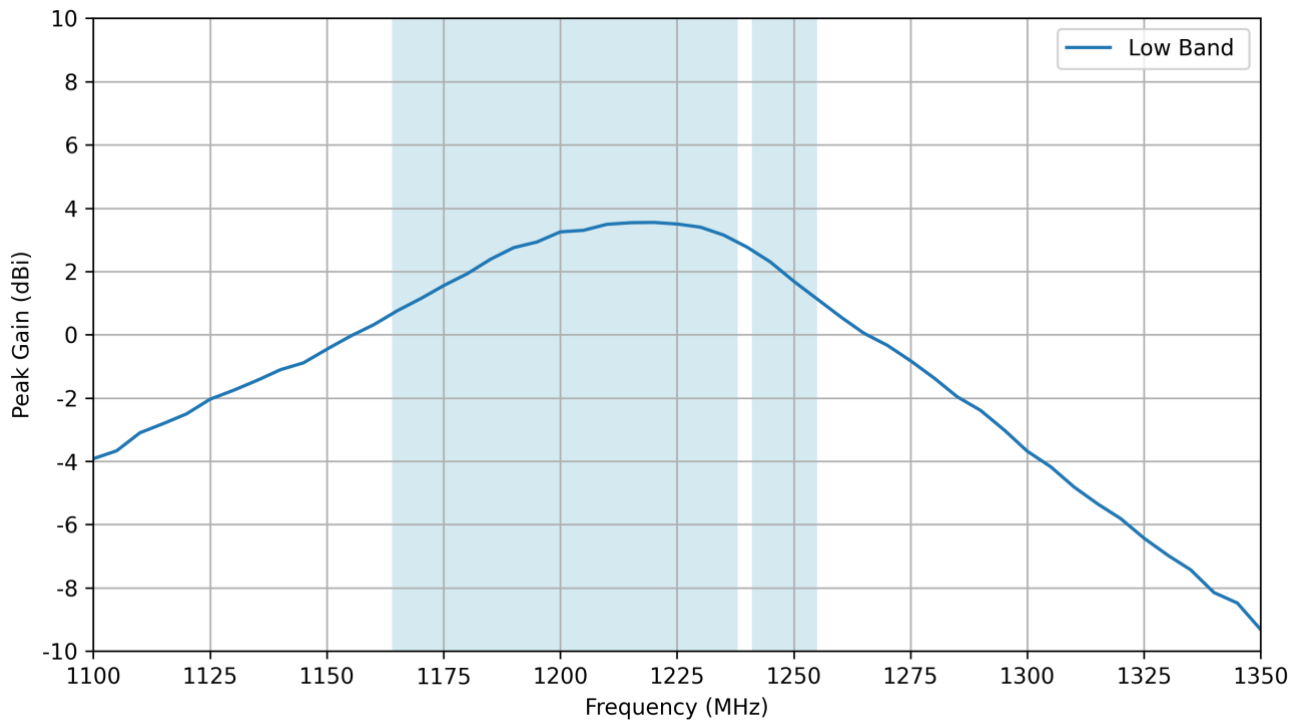

6.9 Peak Gain – High-Band

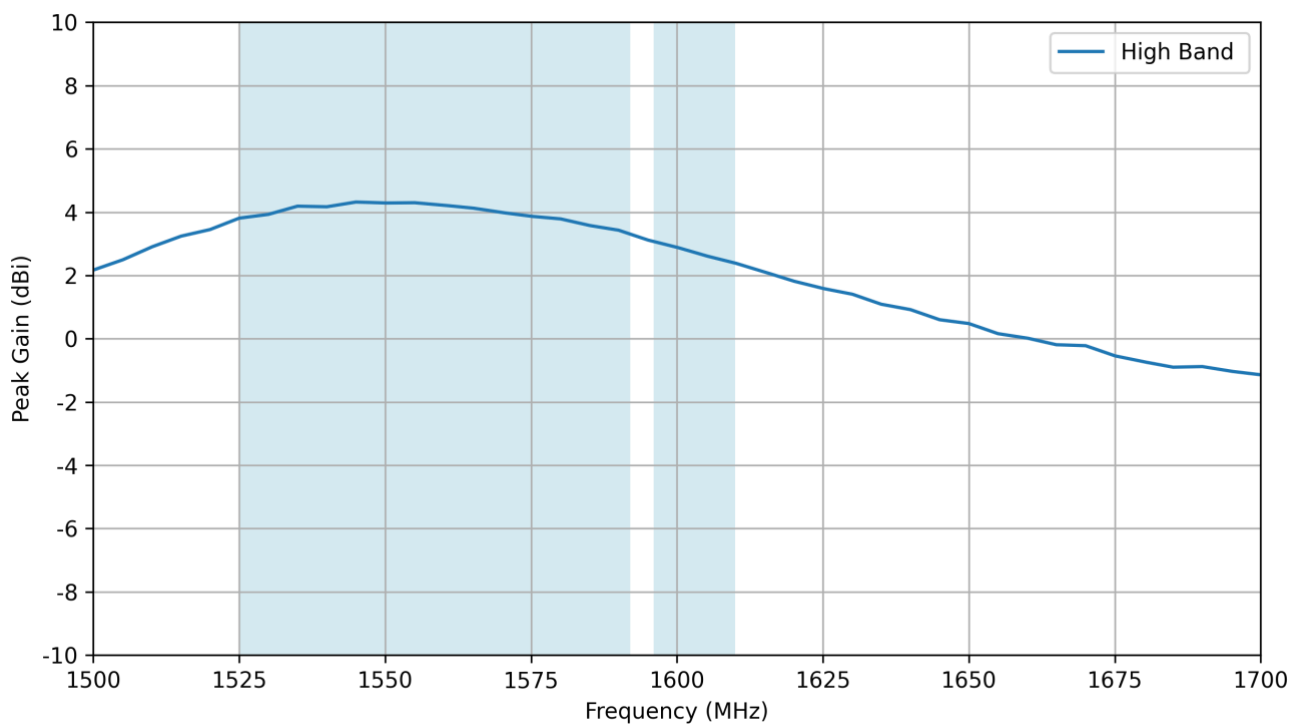

6.10 Axial Ratio vs Frequency

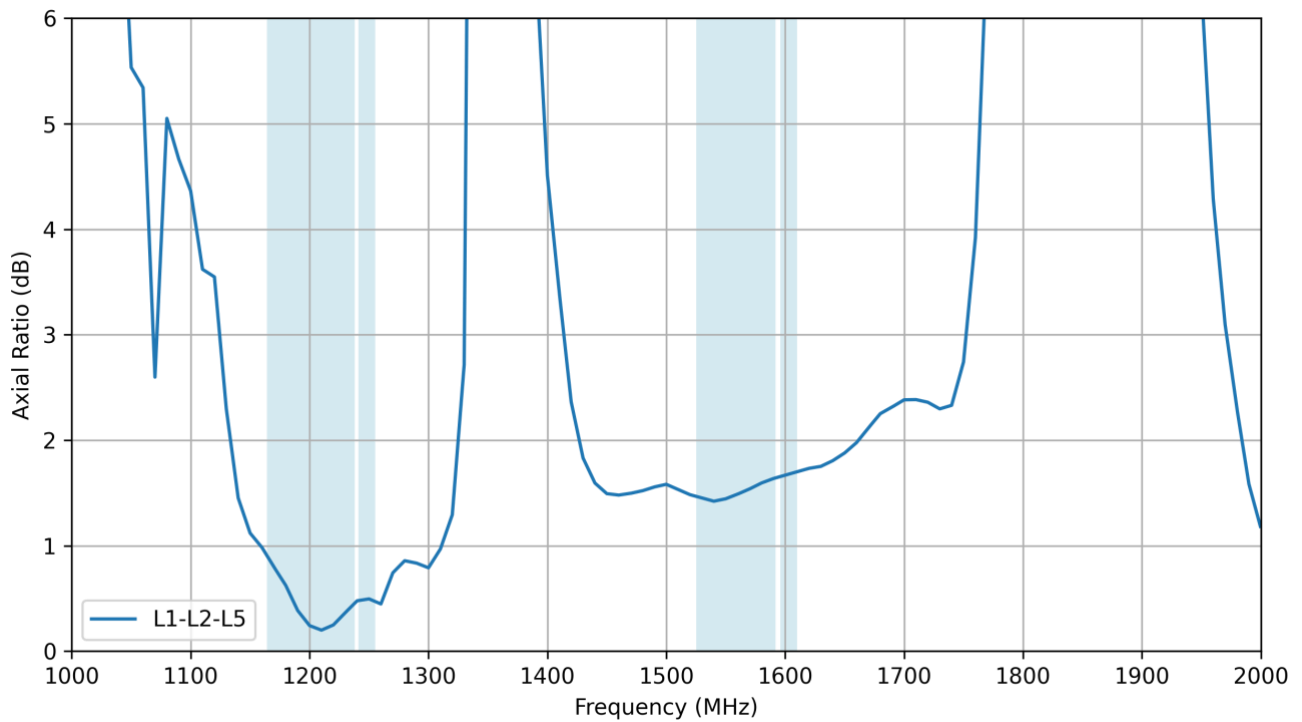

6.11 AR vs Angle for Phi=0

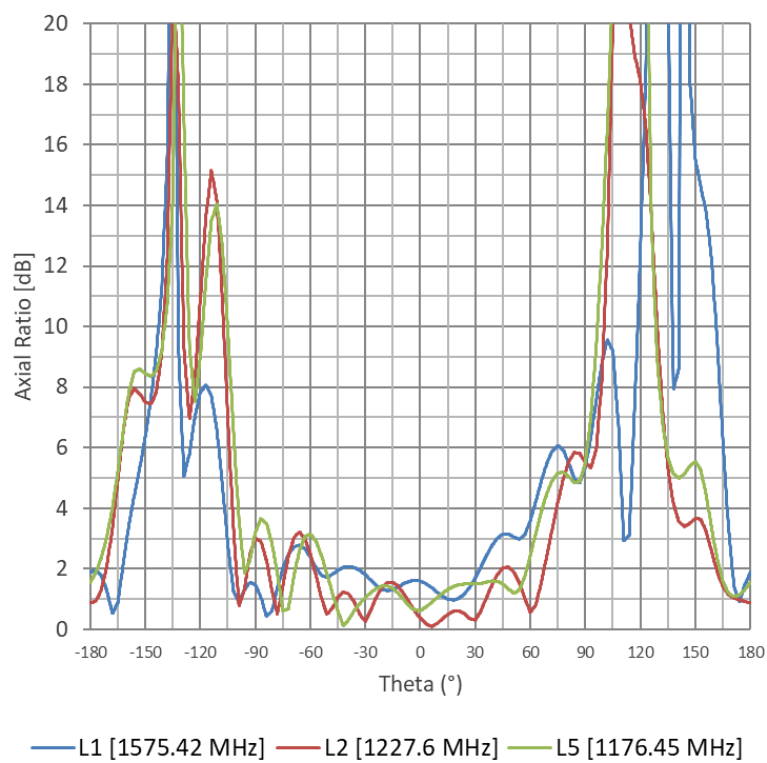

6.12 AR vs Angle for Phi=90

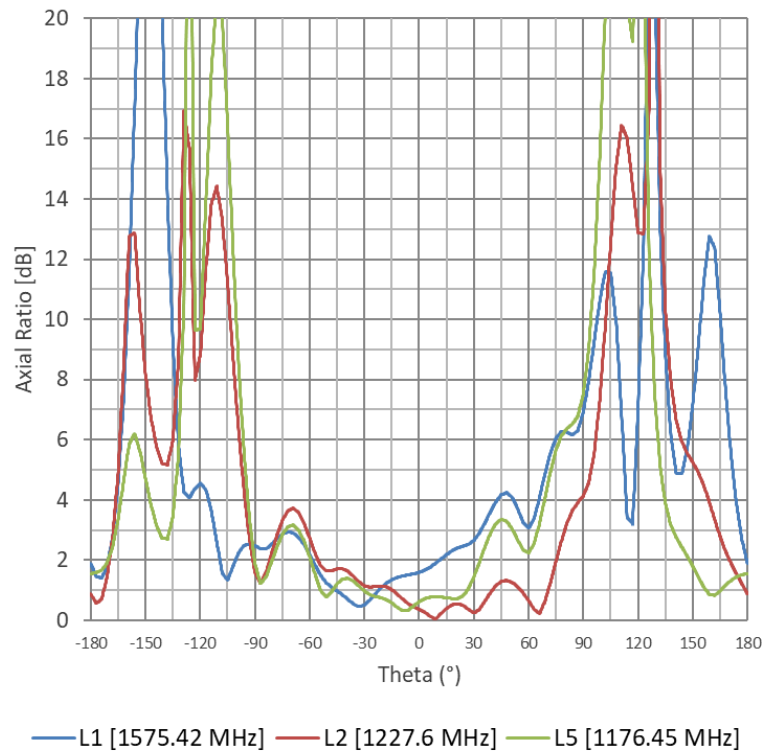

6.13 AR vs Angle for Theta=90

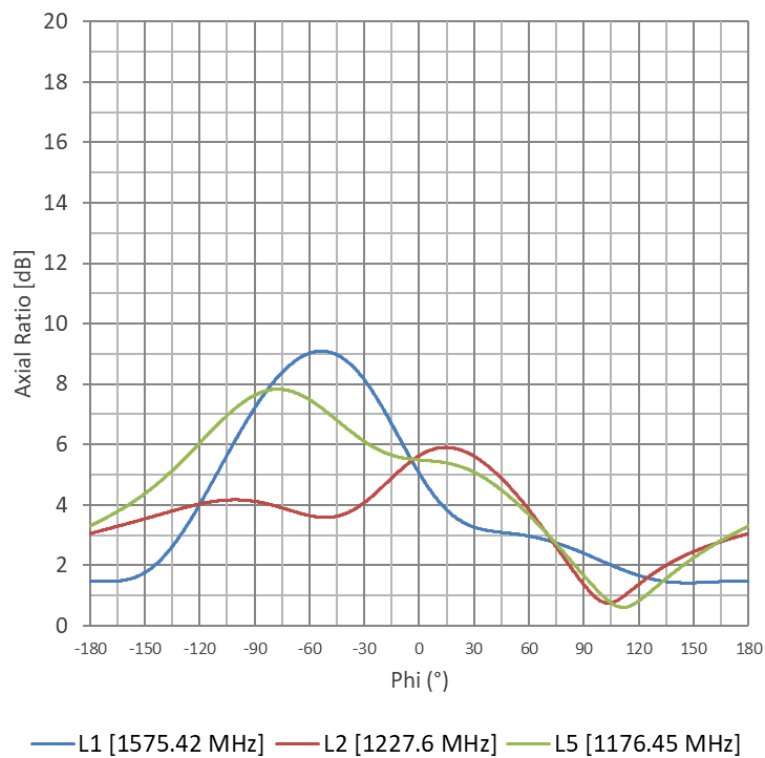

6.14 Phase Center Offset (PCO)

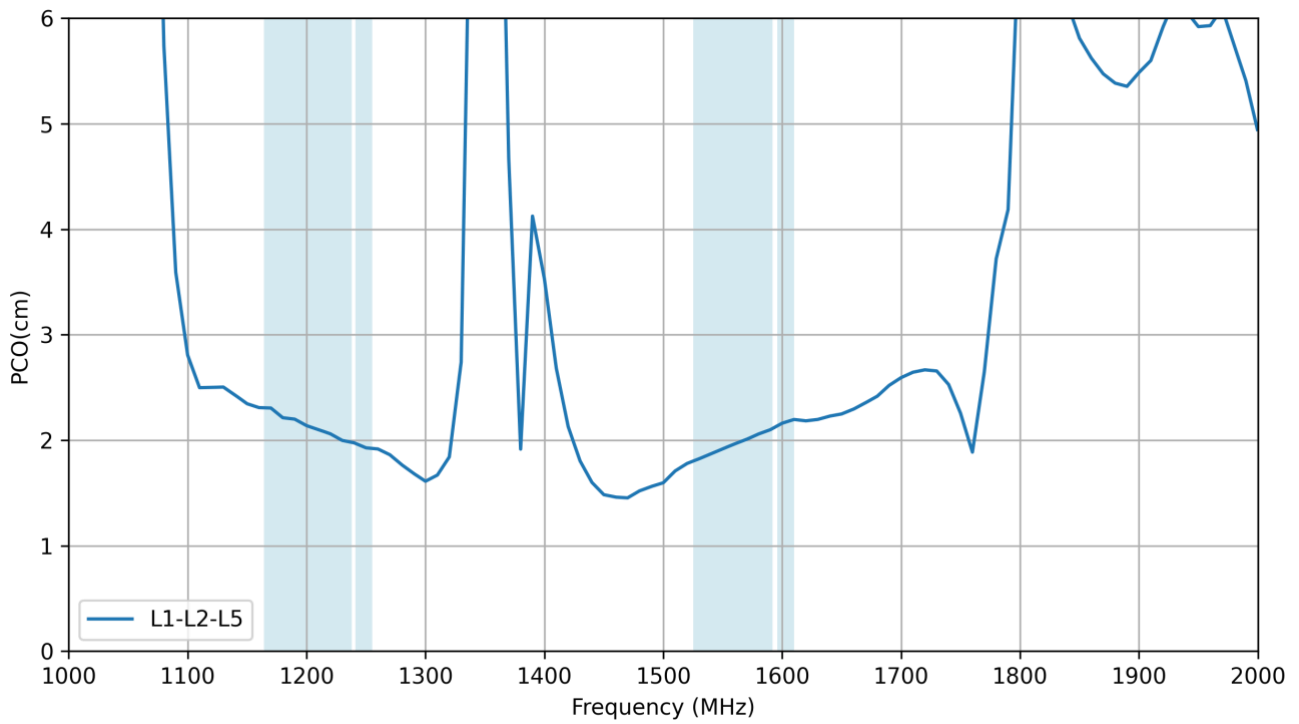

6.15 Phase Center Variation (PCV)

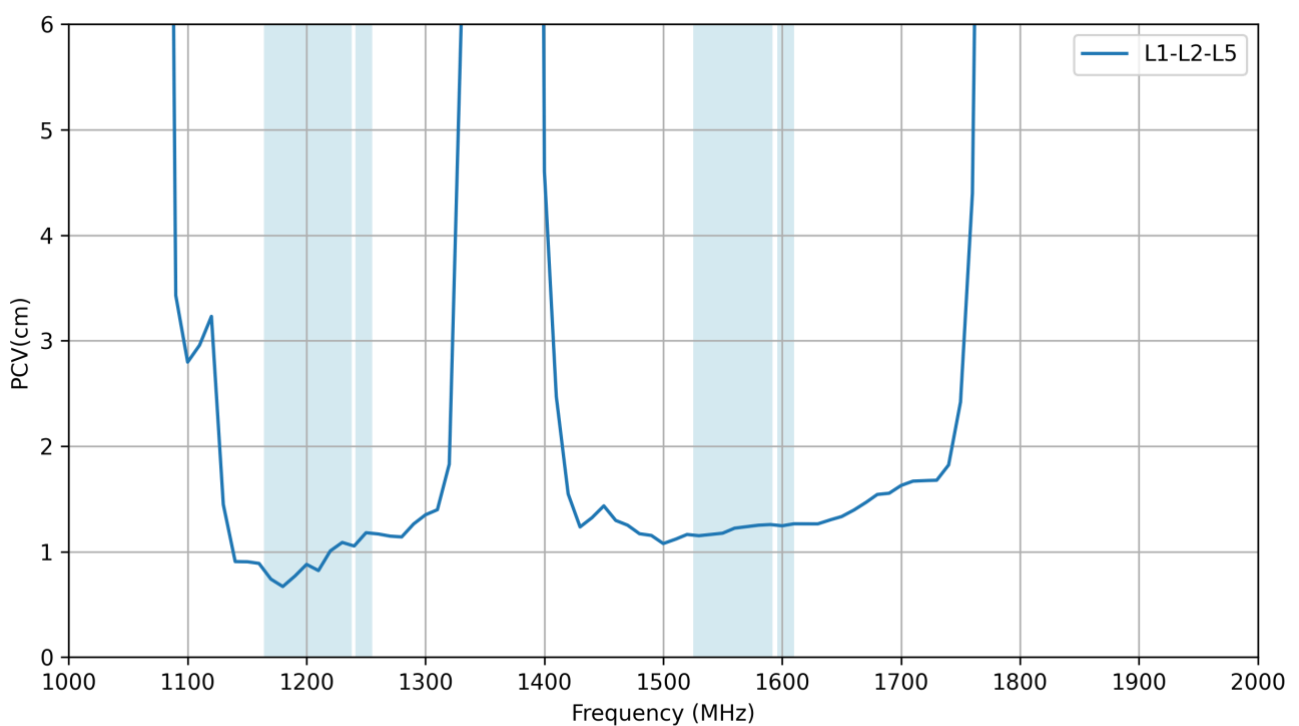

7. LNA Characteristics

7.1 Block Diagram

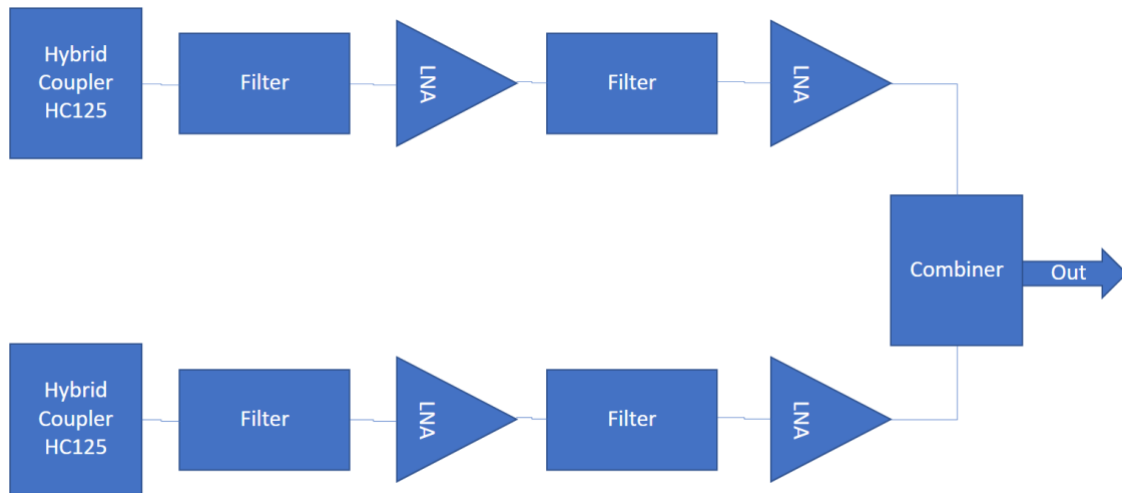

7.2 LNA Gain (Low-Band)

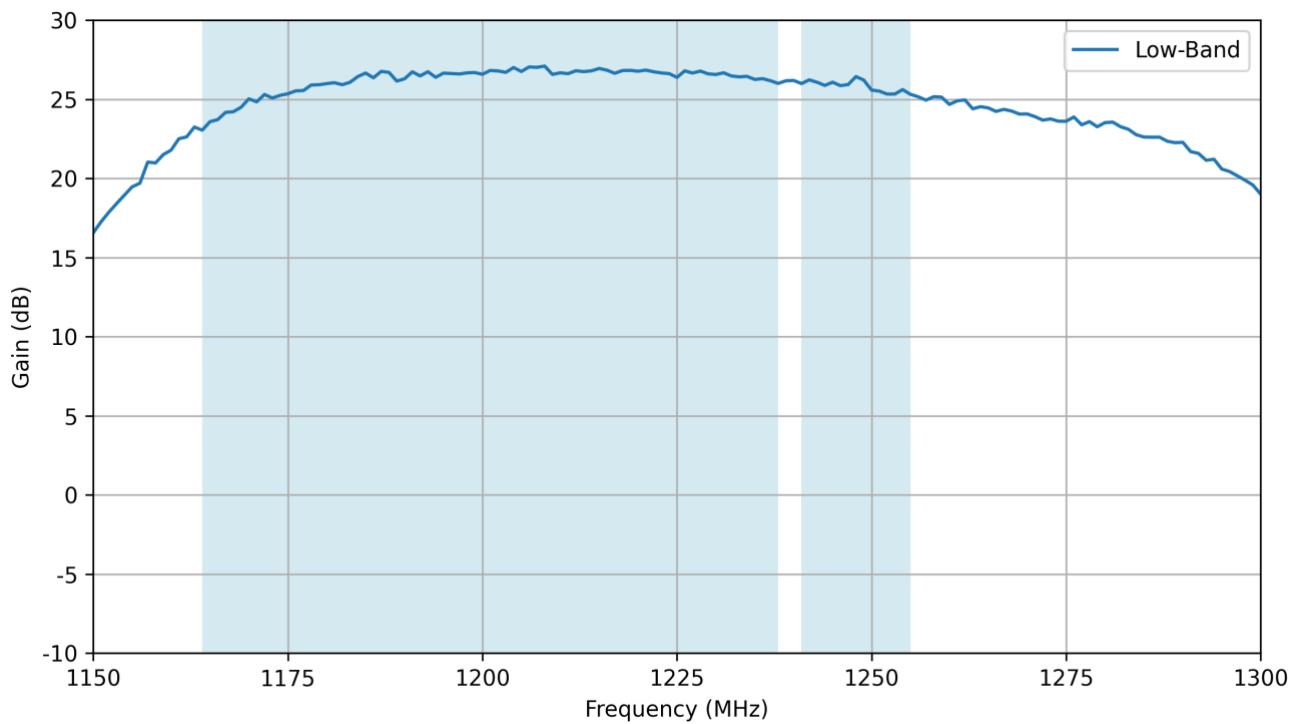

7.3 LNA Gain (High-Band)

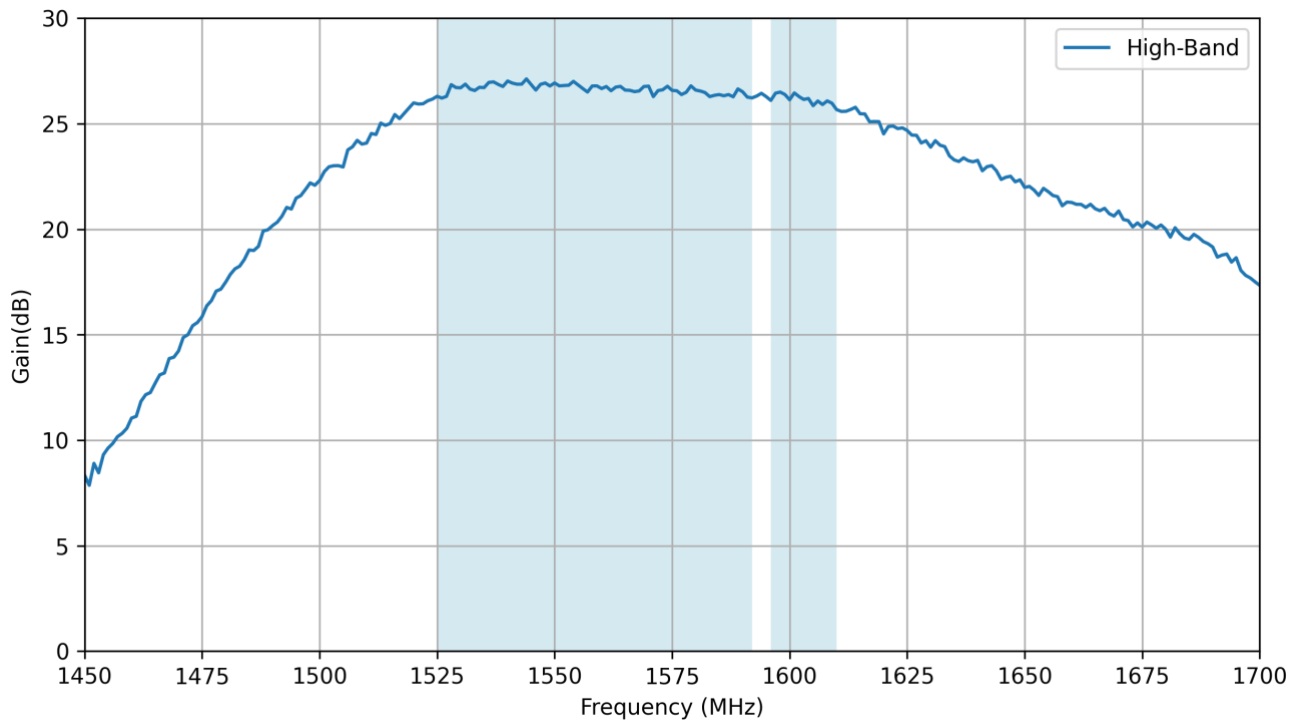

7.4 Noise Figure (Low-Band)

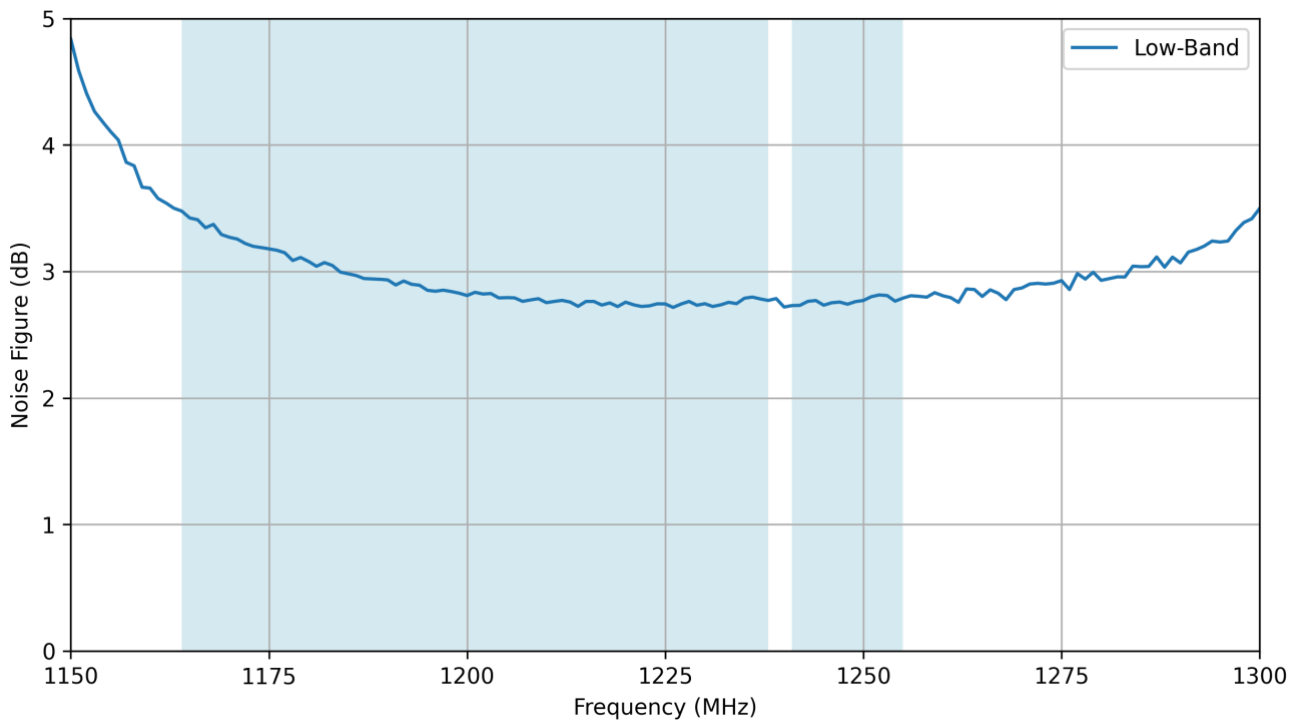

7.5 Noise Figure (High-Band)

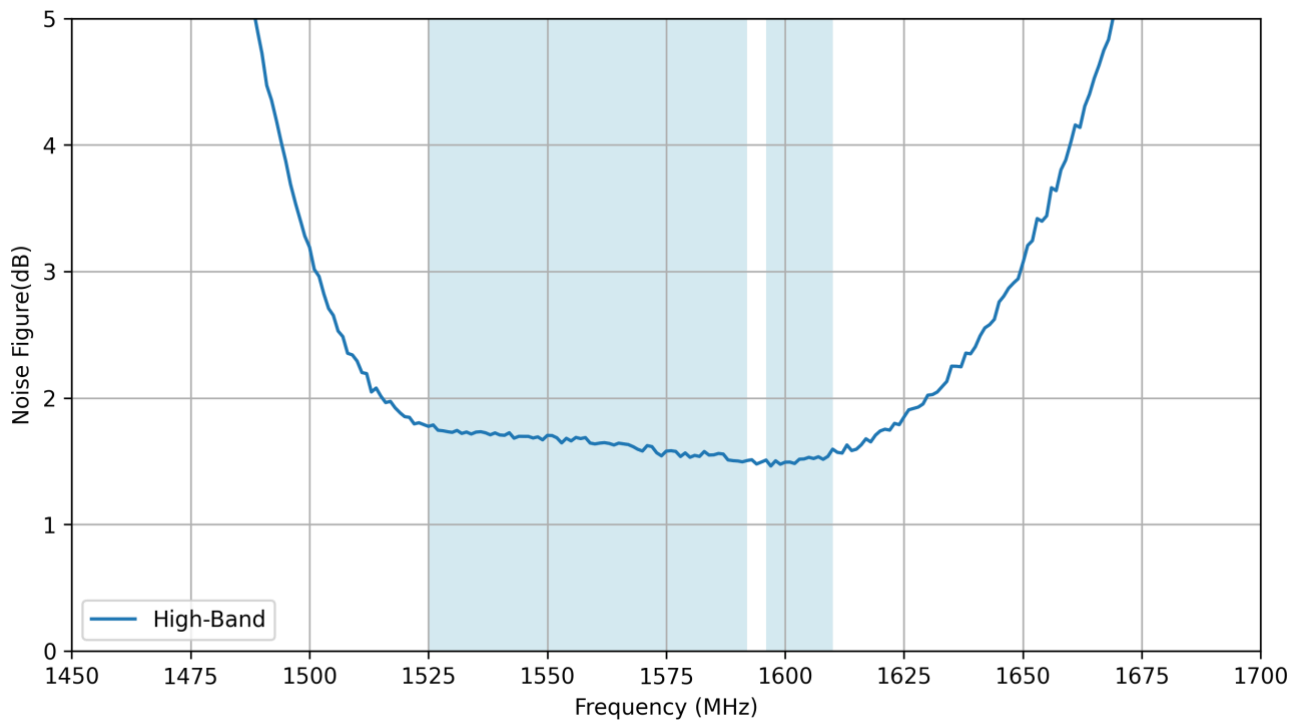

7.6 Out of Band

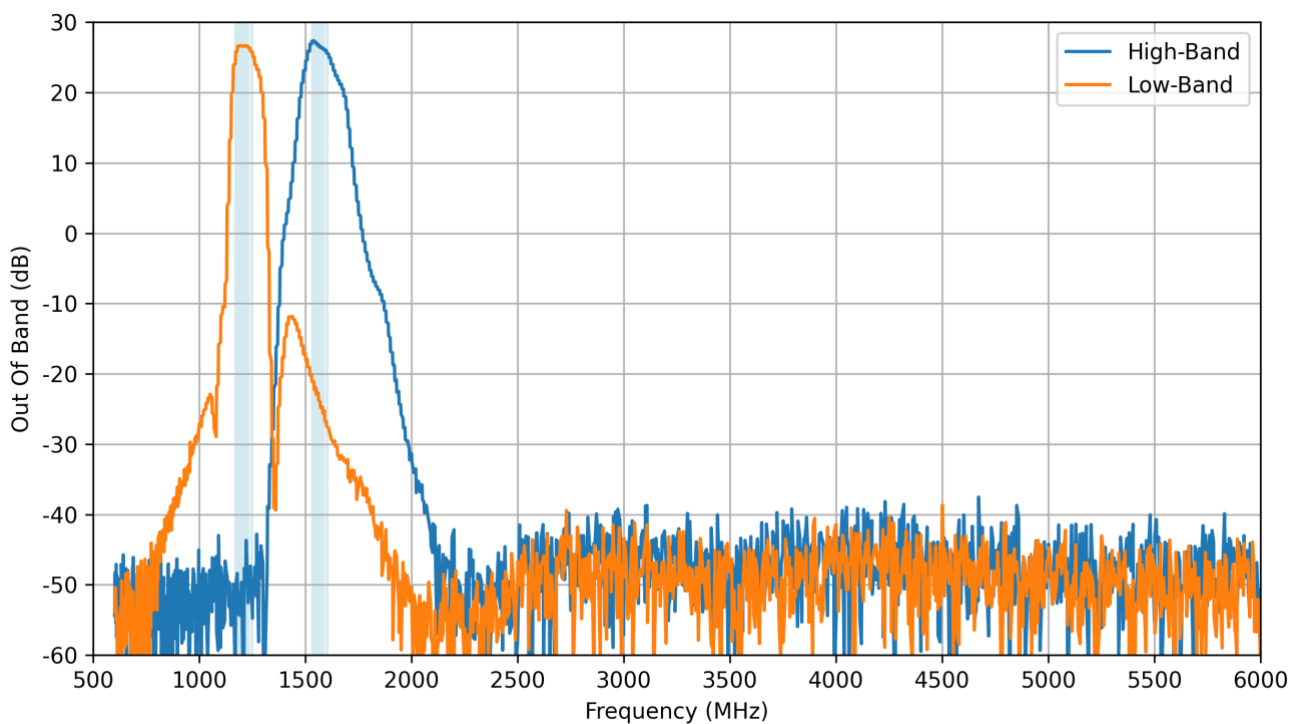

7.7 Group Delay

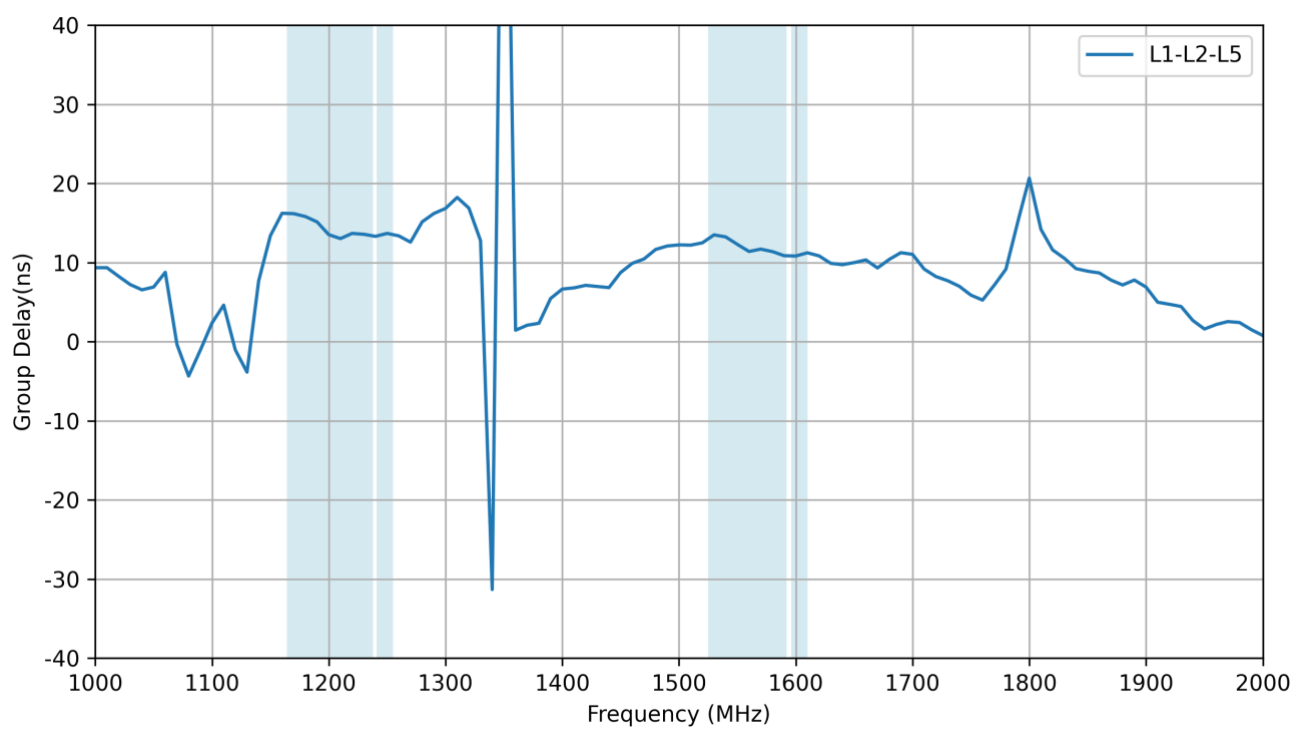

7.8 Full System Gain (Peak Gain)

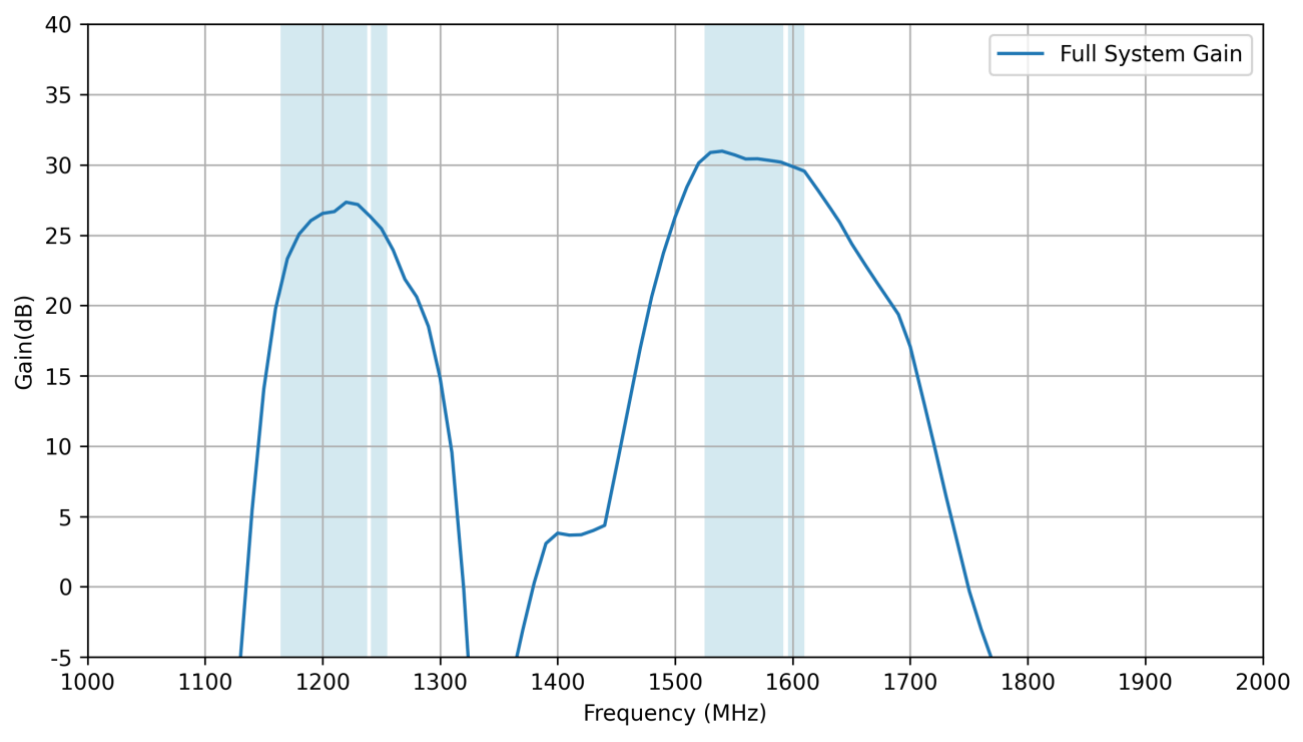

8. Field Test Results

In this section Taoglas will present the field test result for XAHP.30.A.1L21 antenna. The test was performed when the antenna was mounted on a static rooftop test set up in an open sky environment for at least 4 hours.

Taoglas will show the field test results using the following receivers:

8.1 Septentrio - AsteRx-U

Receiver features:

- Multi-band GNSS: 544 channels
- GPS: L1, L2, L5 GLONASS: L1, L2, L3 Galileo: E1, E5ab, AltBoc, E6 BeiDou: B1, B2, B3 NavIC: L51 QZSS: L1, L2, L5, L6
- SBAS: EGNOS, WAAS, GAGAN, MSAS, SDCM(L1, L5)
- RTK (base and rover), Integrated dual-channel L-band receiver, Support for PPP
- Nav. update rate up to 100 Hz
- Position accuracy = RTK 0.6 cm + 0.5 ppm

Positioning Accuracy Table (2D Accuracy)					
Test Condition	Correction Service	CEP (50%)	DRMS (68%)	2DRMS (95%)	TTF (sec)
Free Space	PPP-RTK DISABLED	19.89 cm	23.82 cm	47.63 cm	49
	PPP-RTK ENABLED	5.22 cm	6.32 cm	12.64 cm	55

Signal Quality - No Correction

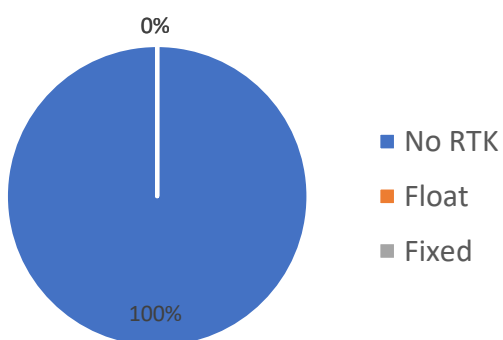

Signal Quality - With Correction

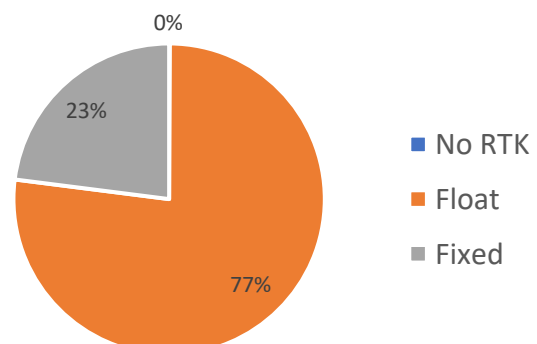

9. Radiation Patterns

9.1 Test Setup

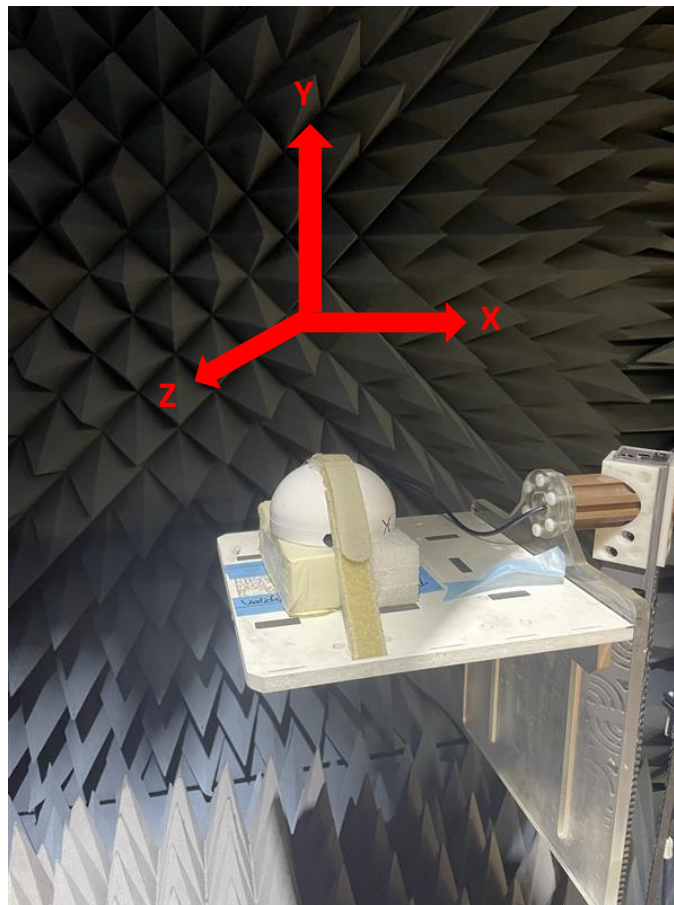
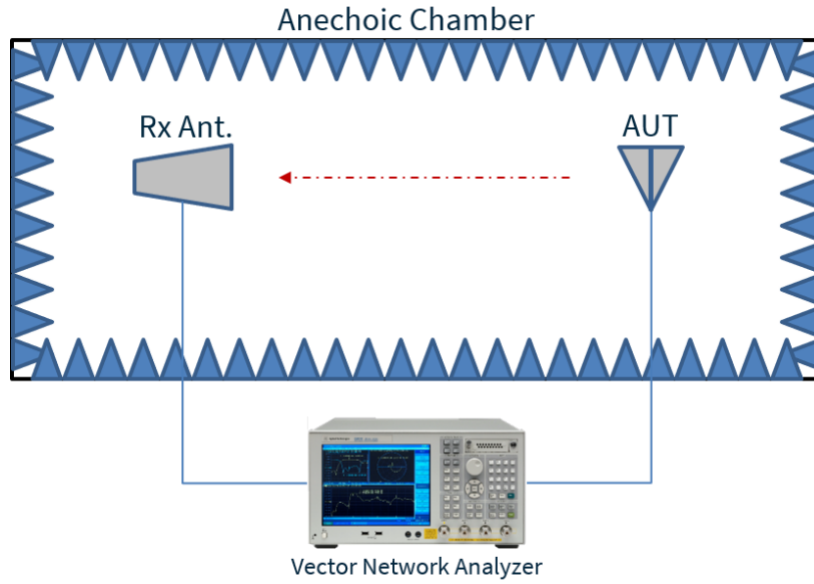

Chamber Test-Setup

9.2 Low Band - Patterns at 1180 MHz

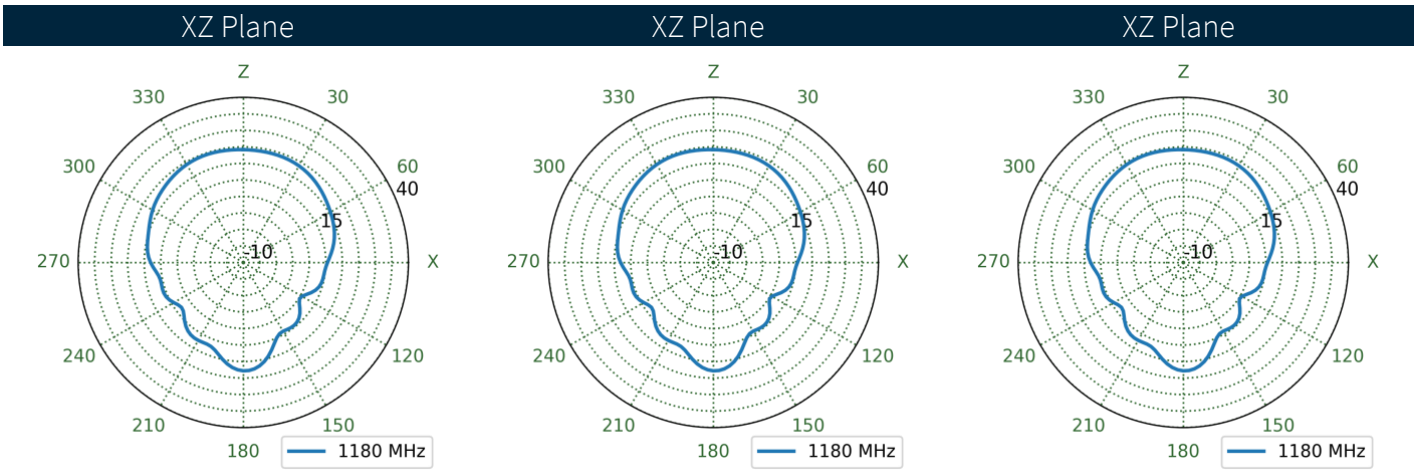
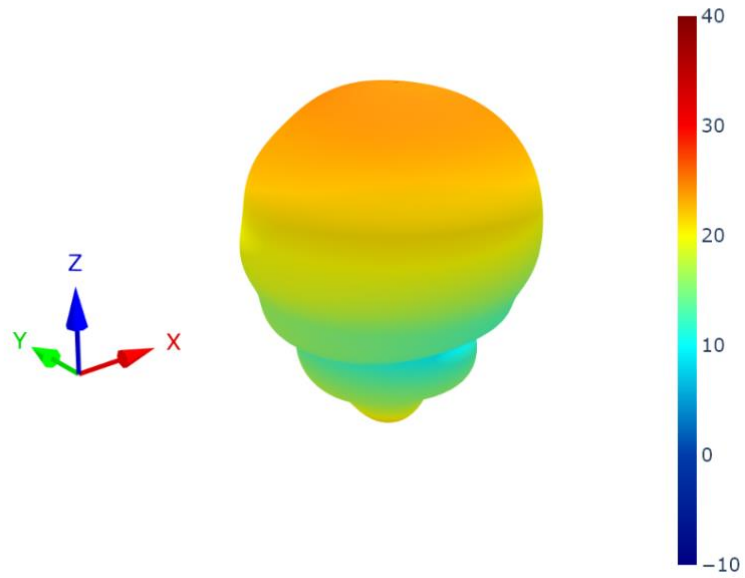

9.3 Low Band - Patterns at 1200 MHz

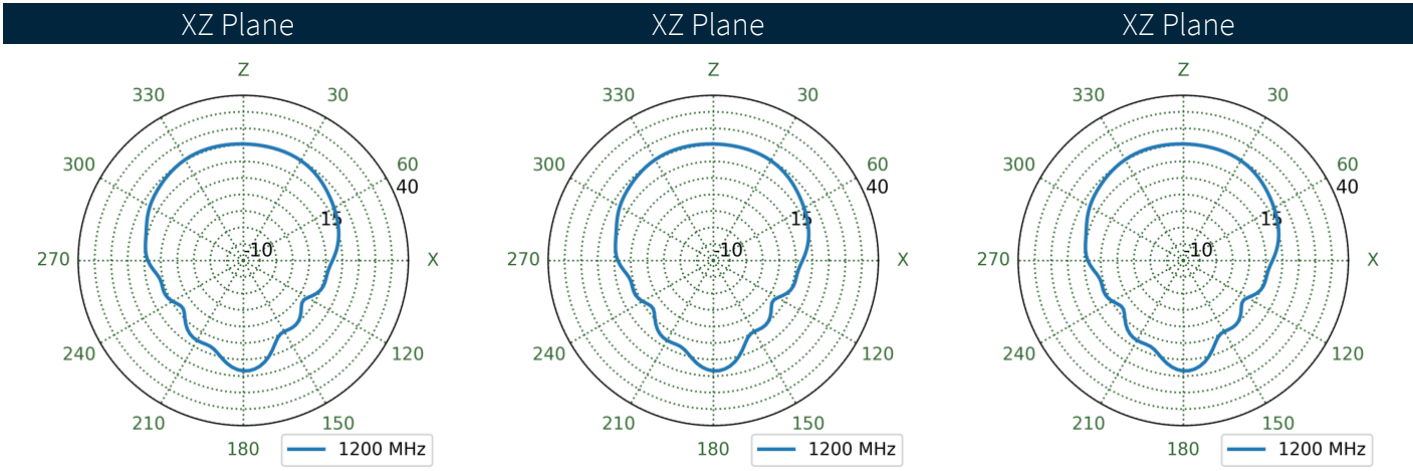
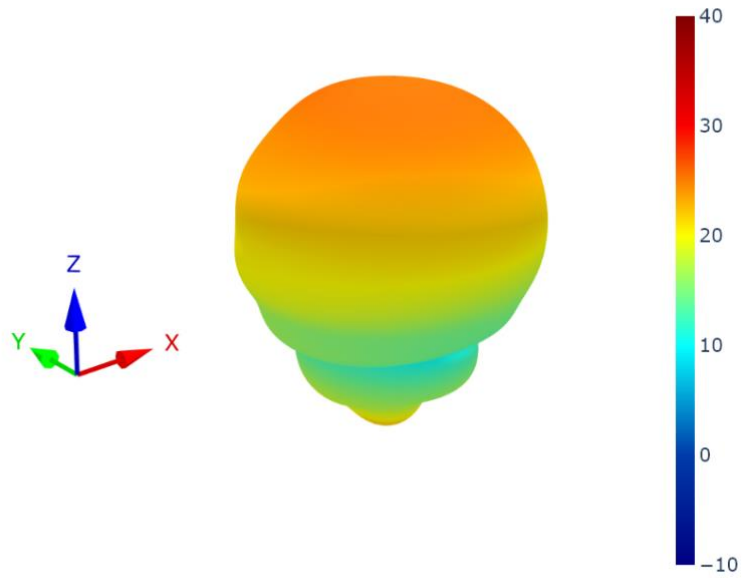

9.4 Low Band - Patterns at 1230 MHz

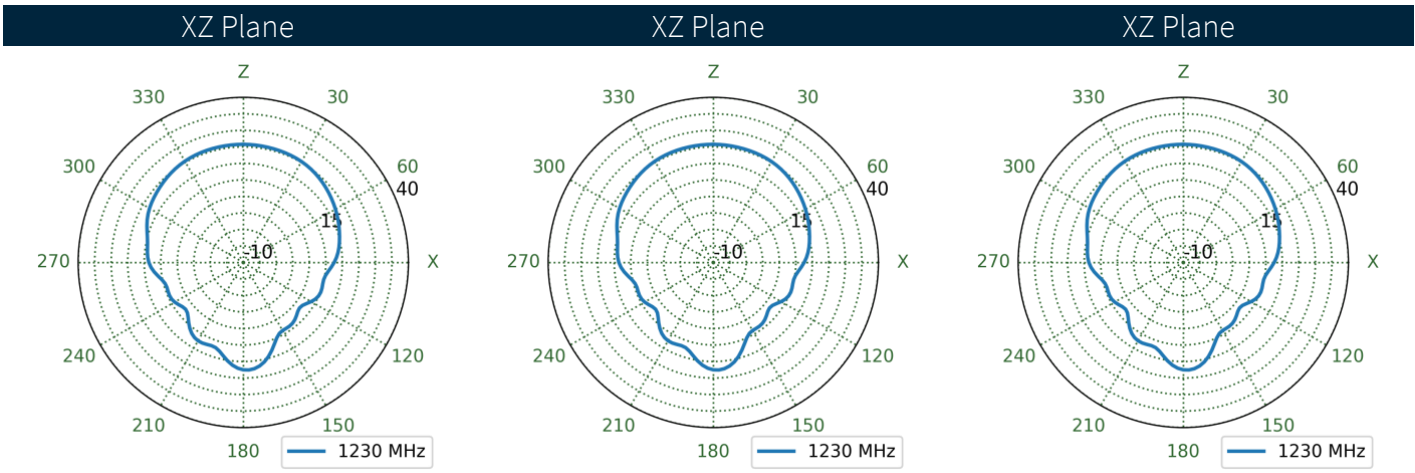
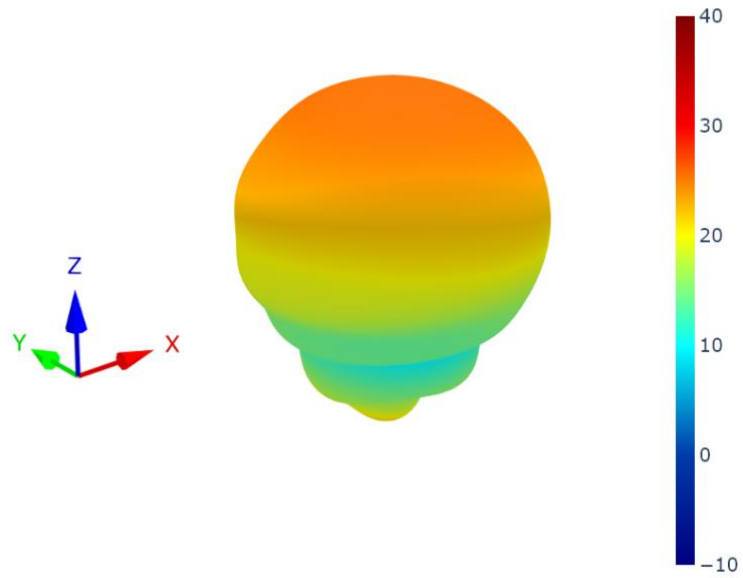

9.5 Low Band - Patterns at 1250 MHz

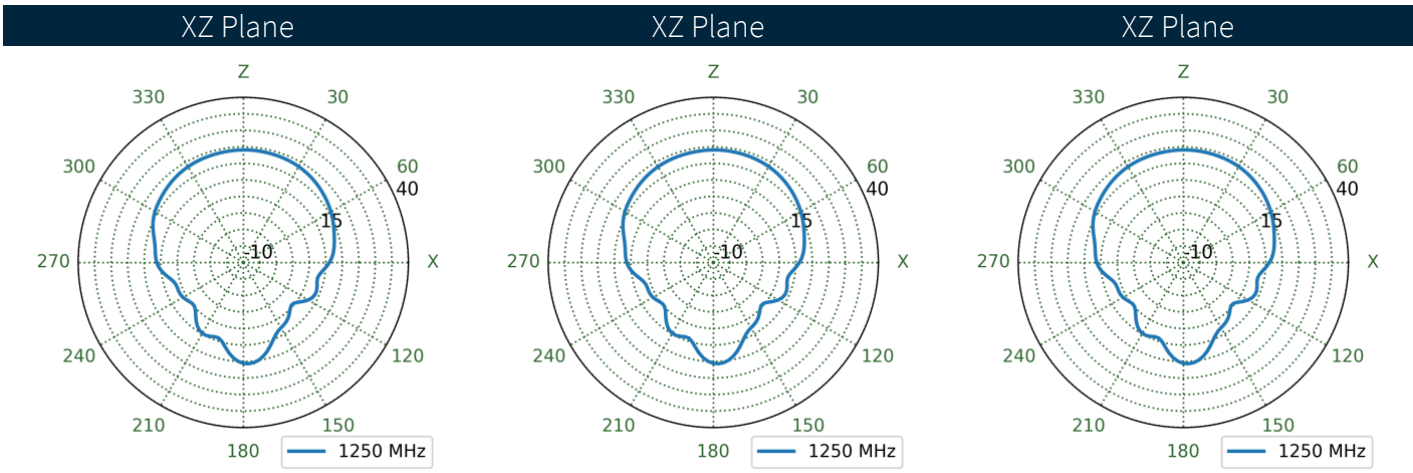
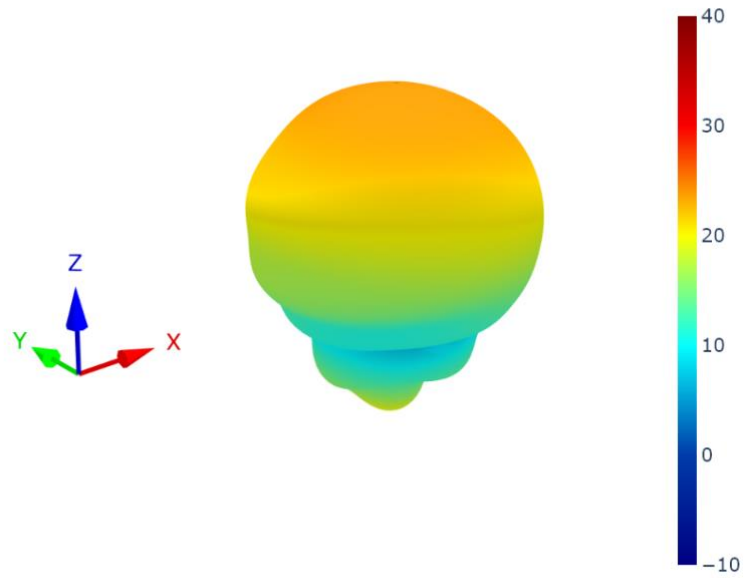

9.6 High Band - Patterns at 1540 MHz

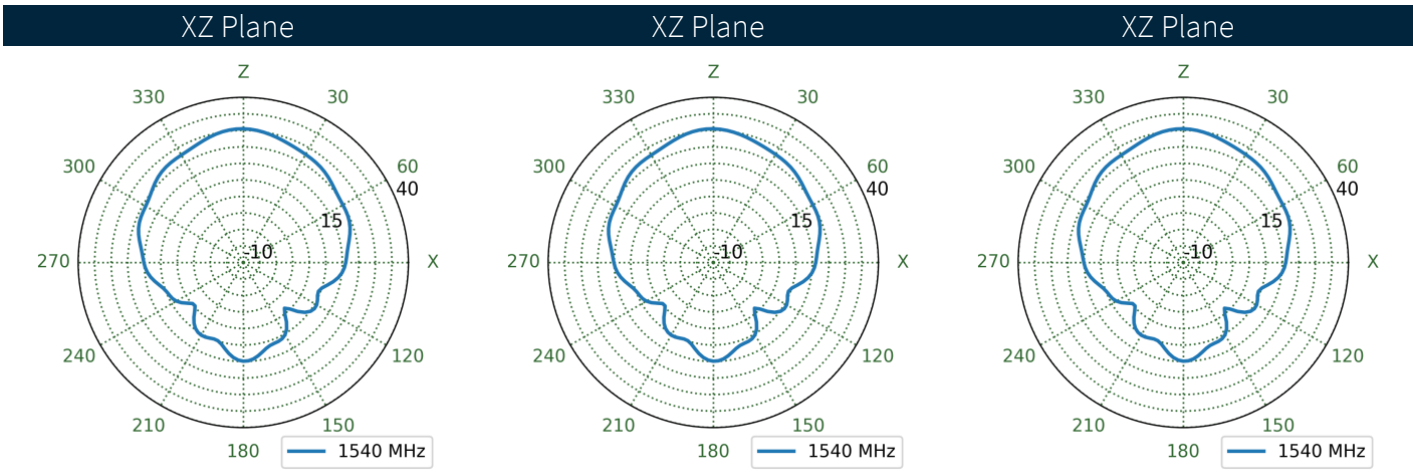
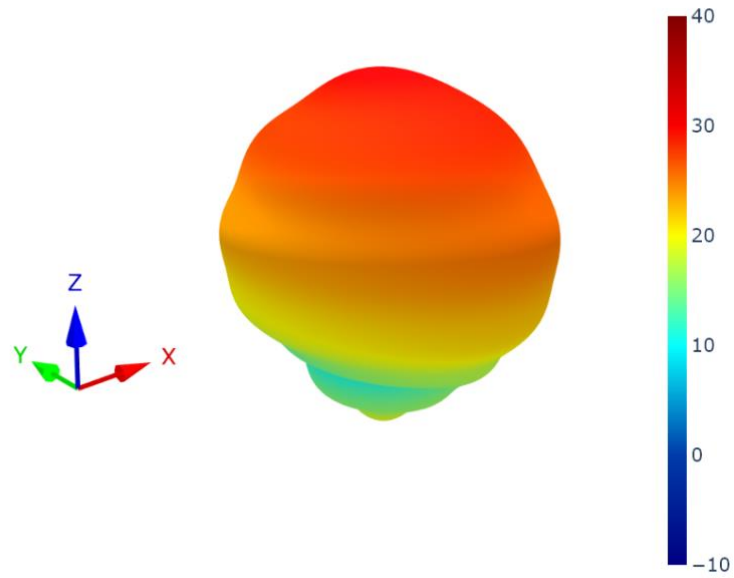

9.7 High Band - Patterns at 1560 MHz

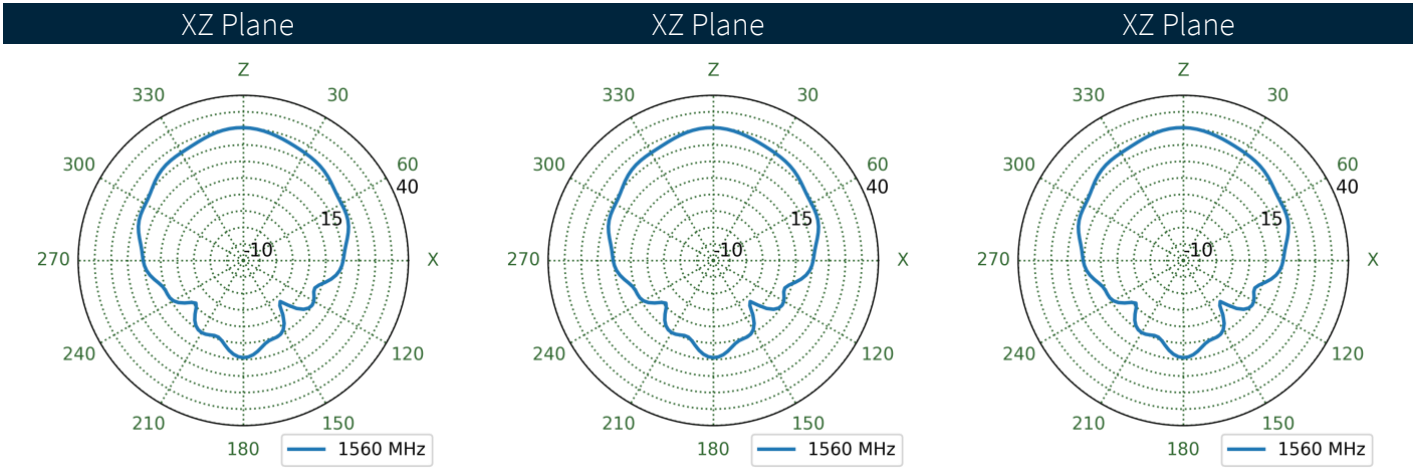
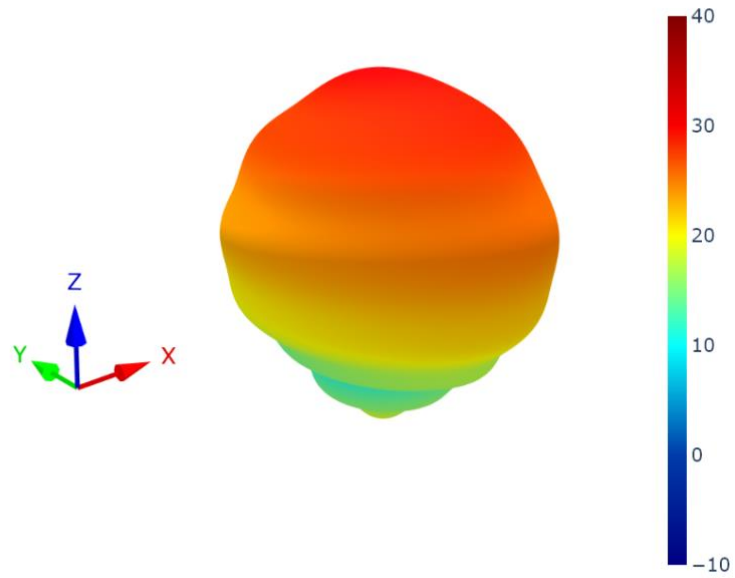

9.8 High Band - Patterns at 1570 MHz

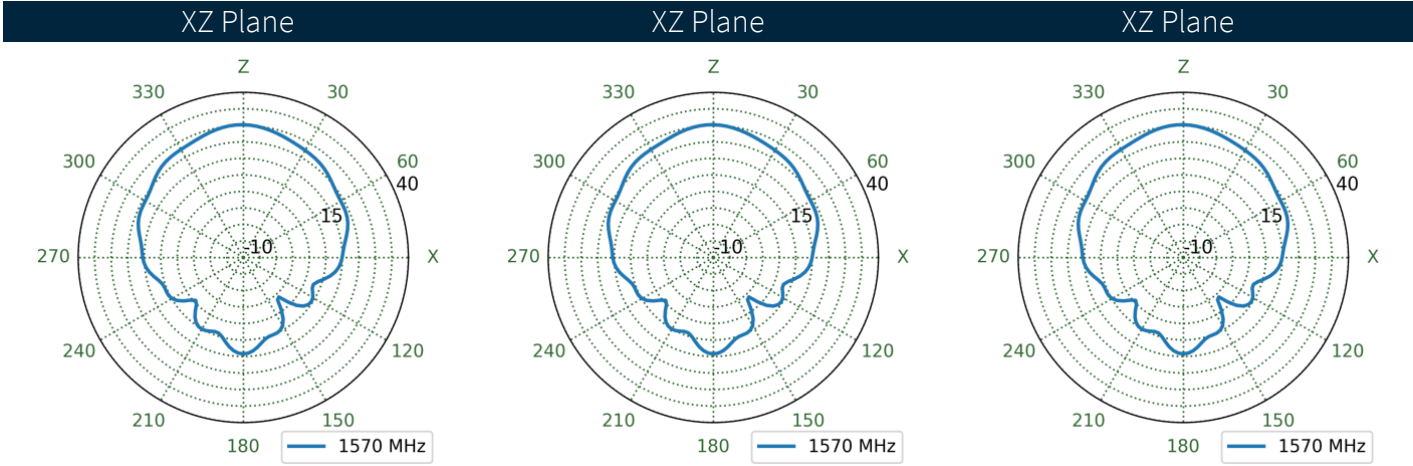
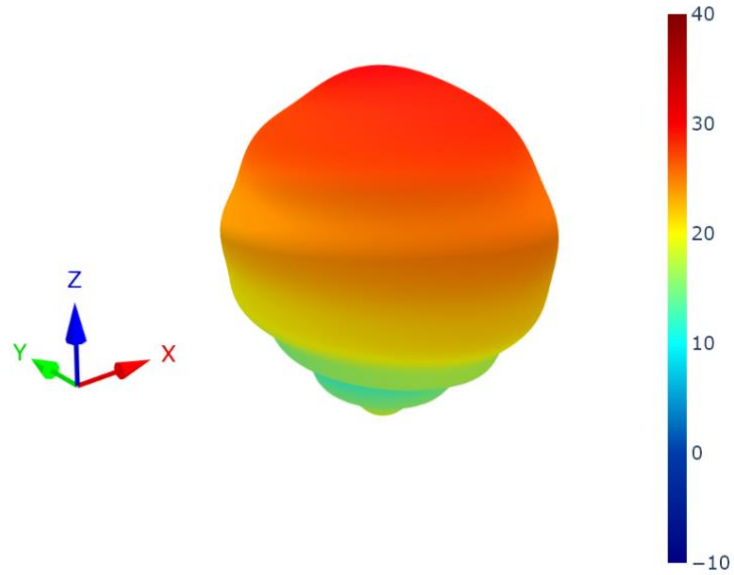

9.9 High Band - Patterns at 1600 MHz

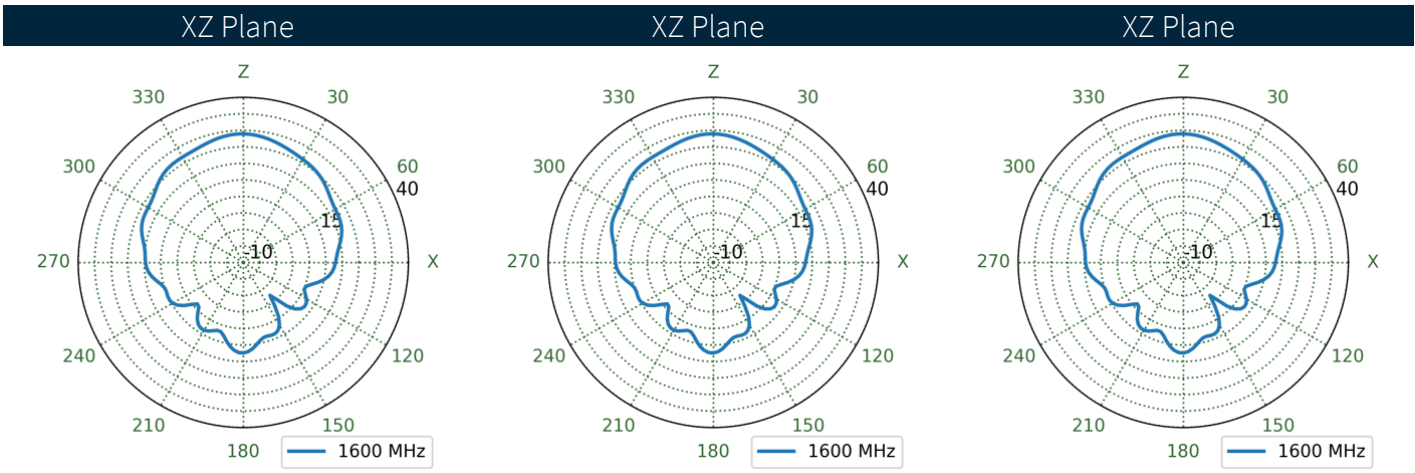
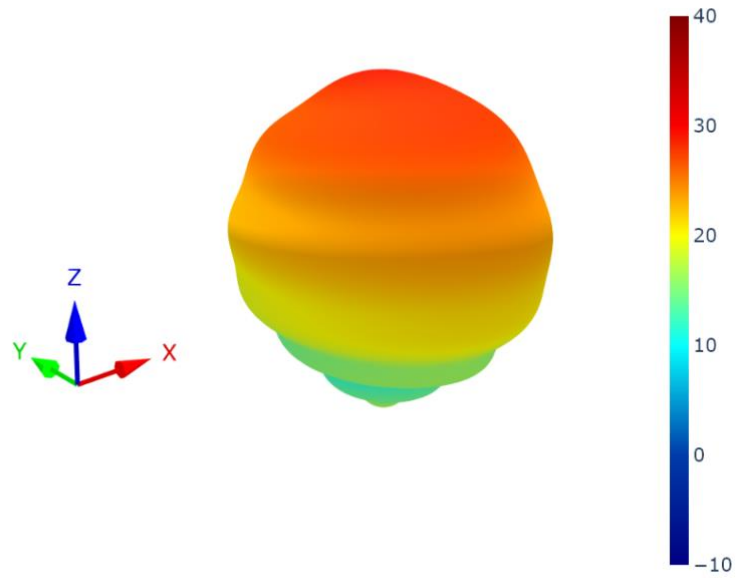

Changelog for the datasheet

SPE-24-8-092 - XAHP.30.A.1L21

Revision: A (Original First Release)

Date: 2024-05-15

Notes: Initial Release

Author: Gary West

Previous Revisions



www.taoglas.com



Mouser Electronics

Authorized Distributor

Click to View Pricing, Inventory, Delivery & Lifecycle Information:

[Taoglas:](#)

[XAHP.30.A.1L21](#)