



# TAOGLAS®



# Datasheet

## Hinged Cellular Antenna

**Part No:**  
TG.09.0113W

### **Description:**

White 4G Terminal Hinged Monopole Antenna  
With SMA(M) Connector

### **Features:**

Covering Worldwide 4G Bands between 700-3800MHz  
Also Covers Several New 5G Sub 6GHz Bands  
Rotatable Hinge Design for Optimal reception  
SMA Male Connector as Standard  
RoHS & Reach Compliant

1. Introduction	3
2. Specifications	4
3. Antenna Characteristics	7
4. Radiation Patterns	12
5. Mechanical Drawing	28
6. Installation	29
7. Packaging	30
8. Application Note	31
<hr/>	
Changelog	38

Taoglas makes no warranties based on the accuracy or completeness of the contents of this document and reserves the right to make changes to specifications and product descriptions at any time without notice. Taoglas reserves all rights to this document and the information contained herein. Reproduction, use or disclosure to third parties without express permission is strictly prohibited.



# 1. Introduction



The Taoglas TG.09 Terminal Mount Cellular Hinged Rotatable SMA Antenna is a high efficiency monopole antenna. Compared to other much larger antennas on the market, it has superior wide-band high efficiency characteristics over worldwide 4G frequency bands. The TG.09 can also be compatible with some 5G Sub 6GHz cellular bands between 3500-3800MHz.

The unique rotatable hinge design enables the user to rotate the antenna to the best angle to optimize cellular signal reception. As the upper antenna element can move in any direction, it also reduces damage from impact force from any angle to the antenna, compared to traditional hinged right angle or fixed right angle designs or straight antennas.

The small form factor of this antenna, coupled with excellent RF performance and an aesthetic high-end design, make it the ideal cellular antenna for routers, vehicle tracking devices, telematics devices, remote monitoring systems, and POS devices.

The TG.09, as do all monopole antennas, works best when connected directly to the ground-plane of the device main-board. Taoglas offers support services to characterize antenna efficiency on your individual device ground-plane.

The TG.09 antenna also supports LTE 700MHz band applications when it is directly connected to ground-planes with dimensions greater than 60mm.

Please contact your regional Taoglas customer support team if you wish to conduct PTCRB or network approvals with this antenna attached to your device. Taoglas can check that the RF integration is correct and we can also conduct pre-tests to ensure optimized passive and active performance and a smooth and quick certification approval process.

The TG.09 is also available with a black enclosure - TG.09.0113.

## 2. Specifications

Electrical								
Frequency (MHz)	704 ~824	824 ~960	1710 ~1880	1850 ~1990	1710 ~2170	2300 ~2400	2490 ~2690	3300 ~3800
Efficiency (%)								
Free Space - Straight	5	8	10.4	15.6	15	25.8	32.8	47.2
Free Space - Bent	10	15	11.5	19.3	18	32.7	41.1	49.3
150*90mm - Straight	63.3	64.5	70.7	74.5	68.4	43.2	35.5	54.1
150*90mm - Bent	44.7	60.2	62.1	64.5	59.4	33.2	43.2	59.7
300*300mm – Edge Straight	63	84.5	77.4	71.4	73.1	68.1	54	86.7
300*300mm – Edge Bent	50.4	77	50.4	69.7	64.8	62.3	42.5	72.5
300*300mm – Center Straight	31	67.5	60.9	86.7	78.2	71.1	50.9	84.3
300*300mm – Center Bent	10.8	18.5	31.4	41.7	41	54.4	42.8	77.5
Average Gain (dB)								
Free Space - Straight	-13.04	-11.3	-9.9	-8.1	-8.4	-5.9	-5	-3.3
Free Space - Bent	-10.3	-8.3	-9.5	-7.3	-7.7	-4.9	-4.1	-3.1
150*90mm - Straight	-2	-1.9	-1.5	-1.3	-1.6	-3.7	-4.5	-2.7
150*90mm - Bent	-3.5	-2.2	-2.1	-1.9	-2.3	-4.7	-3.7	-2.3
300*300mm – Edge Straight	-2.1	-0.7	-1.1	-4	-1.3	-1.7	-2.9	-0.6
300*300mm – Edge Bent	-3.1	-1.1	-3	-1.6	-1.9	-2.1	-4.4	-1.4
300*300mm – Center Straight	-5.3	-1.7	-2.2	-0.6	-1.2	-1.5	-3.7	-0.8
300*300mm – Center Bent	-10.5	-7.5	-5	-3.8	-3.9	-2.3	-4	-1.1
Peak Gain (dBi)								
Free Space - Straight	-7.7	-5.9	-4.2	-3	-3.2	-0.9	0.2	1.6
Free Space - Bent	-6.1	-3.9	-4.6	-2.6	-2.9	0.3	0.7	2.3
150*90mm - Straight	0.7	1	3.4	3.7	3.3	0.8	0.1	3.1
150*90mm - Bent	-1	1.2	3.3	3.4	3	1	2	4.6
300*300mm – Edge Straight	1.4	2.9	3.5	2.5	2.9	3.4	2.6	5.9
300*300mm – Edge Bent	0.5	2.7	1.5	3	2.6	2.1	-0.1	3.1
300*300mm – Center Straight	-2.4	2	2.1	3.7	3.3	3.3	1.8	4.7
300*300mm – Center Bent	-4.3	-1.8	-0.4	1.1	0.8	1.4	0.4	3.1
<b>Impedance</b>	50Ω							
<b>Polarization</b>	Linear							
<b>Radiation Pattern</b>	Omnidirectional							
<b>Max. input power</b>	10W							

<b>Mechanical</b>	
<b>Antenna Length</b>	72mm
<b>Antenna Diameter</b>	10mm
<b>Casing</b>	POM
<b>Connector</b>	SMA Male Hinged
<b>Weight</b>	8g
<b>Environmental</b>	
<b>Temperature Range</b>	-40°C to +85°C
<b>Humidity</b>	Non-condensing 65°C 95% RH

5G/4G Bands			
Band Number	5GNR / FR1 / LTE / LTE-Advanced / WCDMA / HSPA / HSPA+ / TD-SCDMA		
	Uplink	Downlink	Covered
1	UL: 1920 to 1980	DL: 2110 to 2170	✓
2	UL: 1850 to 1910	DL: 1930 to 1990	✓
3	UL: 1710 to 1785	DL: 1805 to 1880	✓
4	UL: 1710 to 1755	DL: 2110 to 2155	✓
5	UL: 824 to 849	DL: 869 to 894	✓
7	UL: 2500 to 2570	DL: 2620 to 2690	✓
8	UL: 880 to 915	DL: 925 to 960	✓
9	UL: 1749.9 to 1784.9	DL: 1844.9 to 1879.9	✓
11	UL: 1427.9 to 1447.9	DL: 1475.9 to 1495.9	✗
12	UL: 699 to 716	DL: 729 to 746	✓
13	UL: 777 to 787	DL: 746 to 756	✓
14	UL: 788 to 798	DL: 758 to 768	✓
17	UL: 704 to 716	DL: 734 to 746	✓
18	UL: 815 to 830	DL: 860 to 875	✓
19	UL: 830 to 845	DL: 875 to 890	✓
20	UL: 832 to 862	DL: 791 to 821	✓
21	UL: 1447.9 to 1462.9	DL: 1495.9 to 1510.9	✗
22	UL: 3410 to 3490	DL: 3510 to 3590	✓
23	UL: 2000 to 2020	DL: 2180 to 2200	✓
24	UL: 1625.5 to 1660.5	DL: 1525 to 1559	✗
25	UL: 1850 to 1915	DL: 1930 to 1995	✓
26	UL: 814 to 849	DL: 859 to 894	✓
27	UL: 807 to 824	DL: 852 to 869	✓
28	UL: 703 to 748	DL: 758 to 803	✓
29	UL: -	DL: 717 to 728	✓
30	UL: 2305 to 2315	DL: 2350 to 2360	✓
31	UL: 452.5 to 457.5	DL: 462.5 to 467.5	✗
32	UL: -	DL: 1452 - 1496	✗
35		1850 to 1910	✓
38		2570 to 2620	✓
39		1880 to 1920	✓
40		2300 to 2400	✓
41		2496 to 2690	✓
42		3400 to 3600	✓
43		3600 to 3800	✓
48		3550 to 3700	✓
66	UL: 1710-1780	DL: 2110-2200	✓
71		617 to 698	✗
74/75/76		1427 to 1518	✗
78		3300 to 3800	✓
79		4400 to 5000	✗

\* Covered Bands represent greater than 20% efficiency

### 3. Antenna Characteristics

#### 3.1 Return Loss

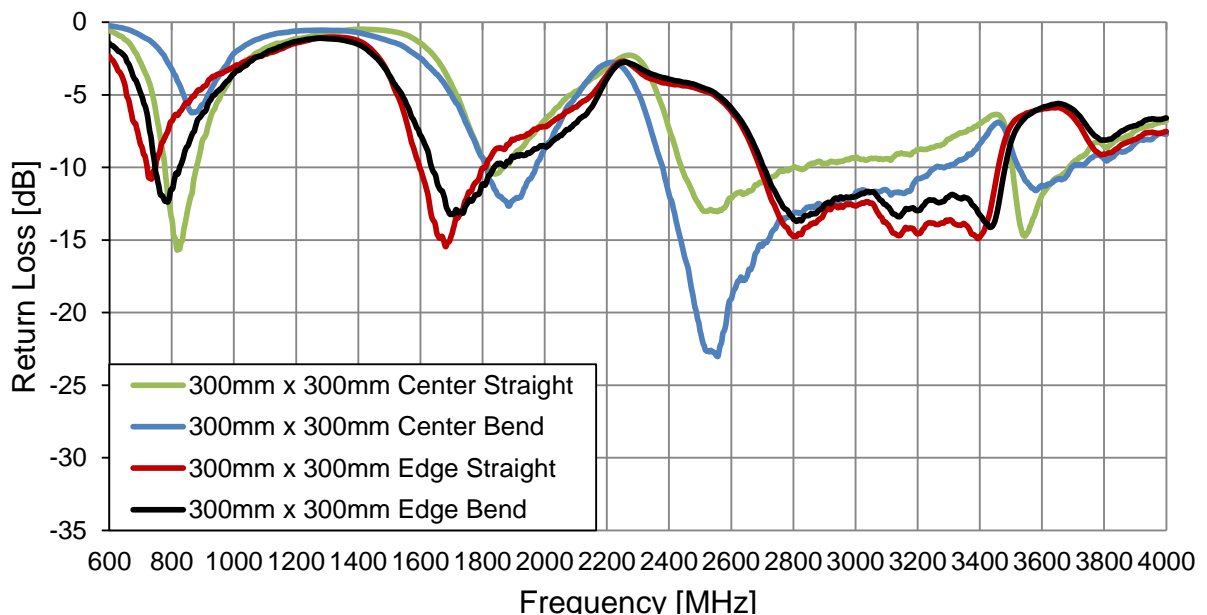
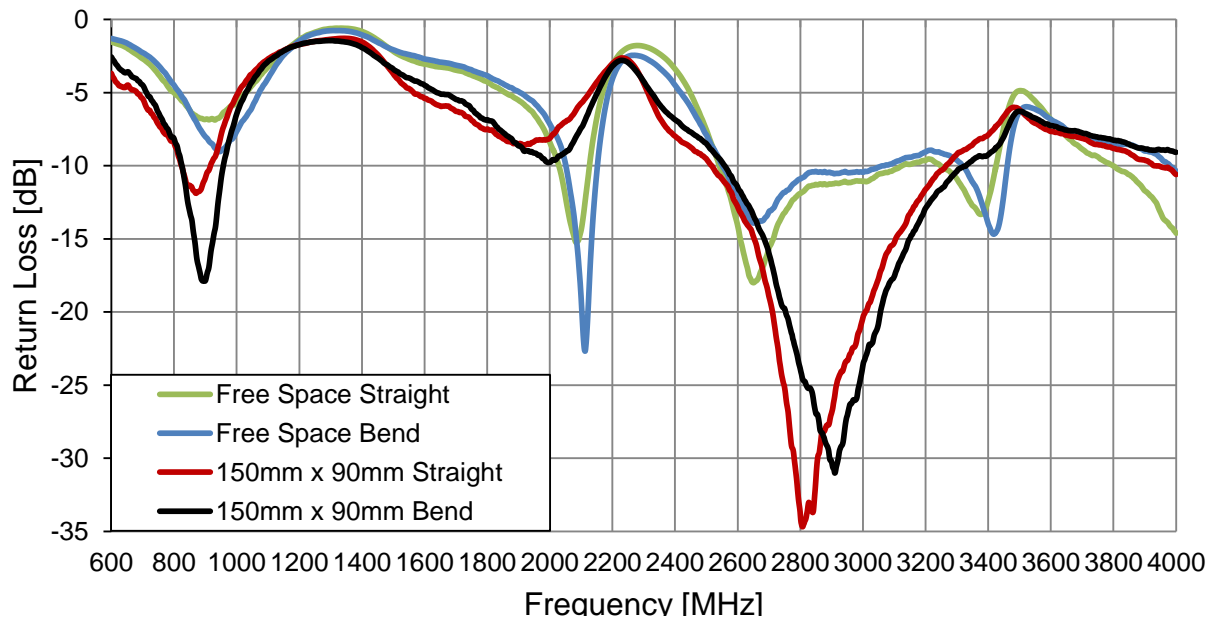

### 3.2 VSWR

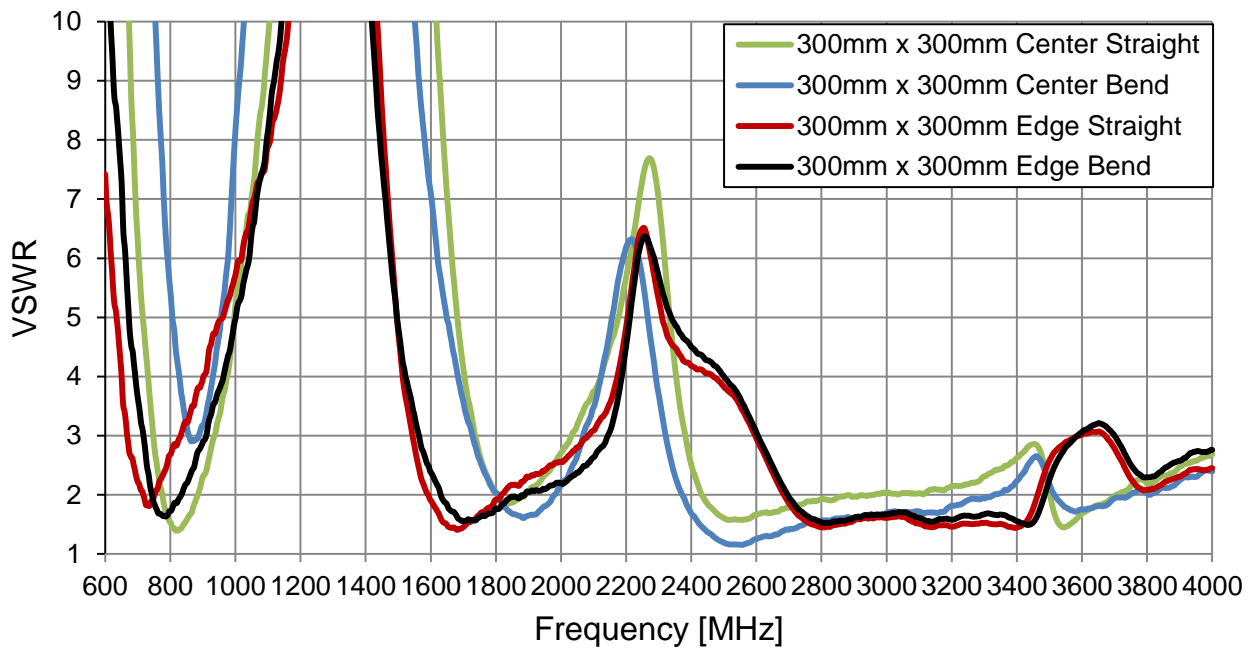
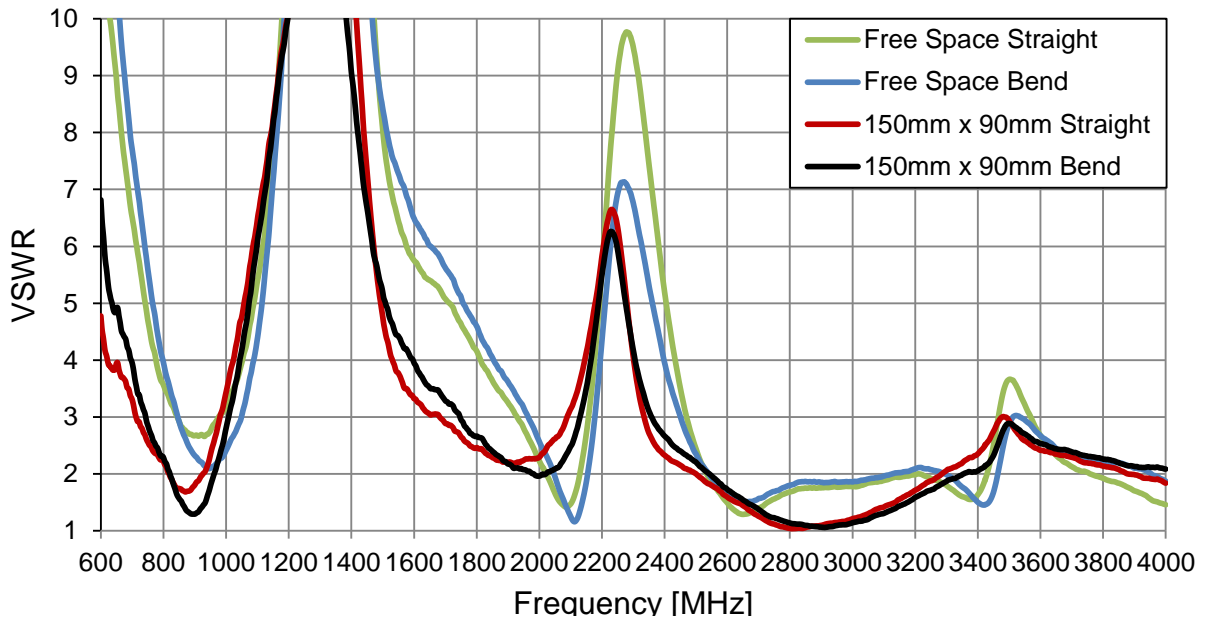



### 3.3 Efficiency

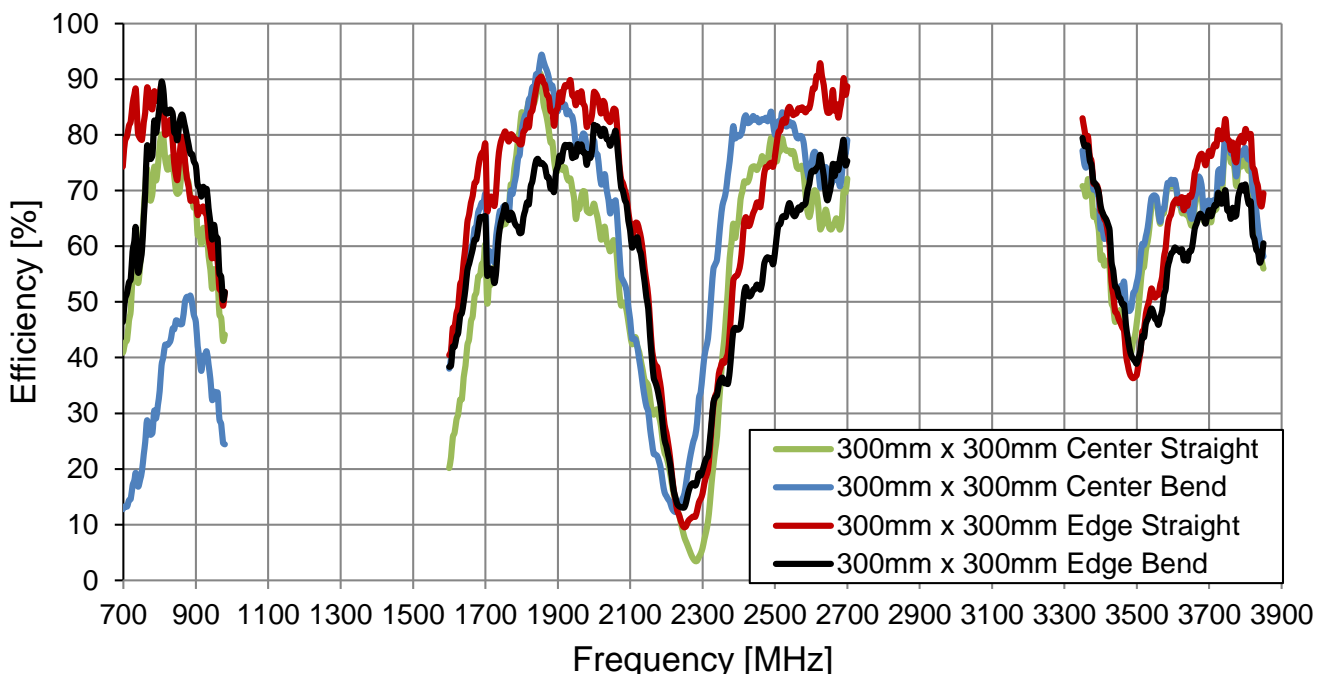
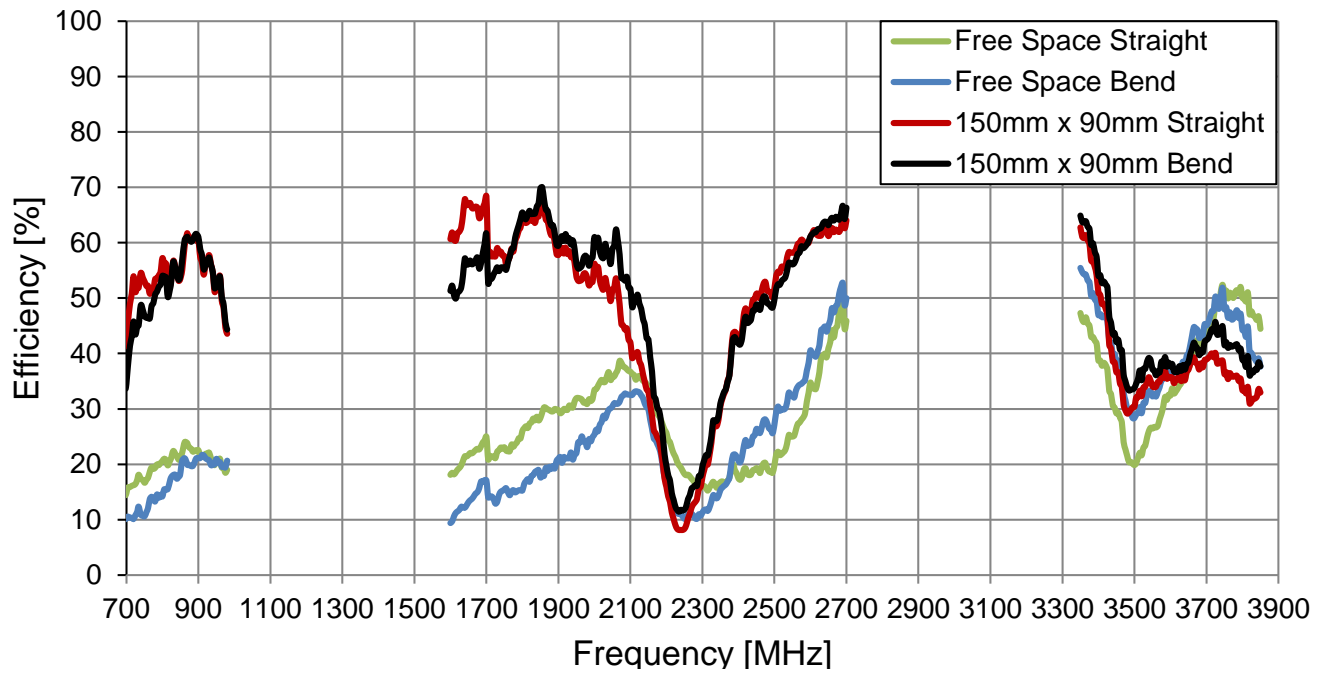

### 3.4 Peak Gain

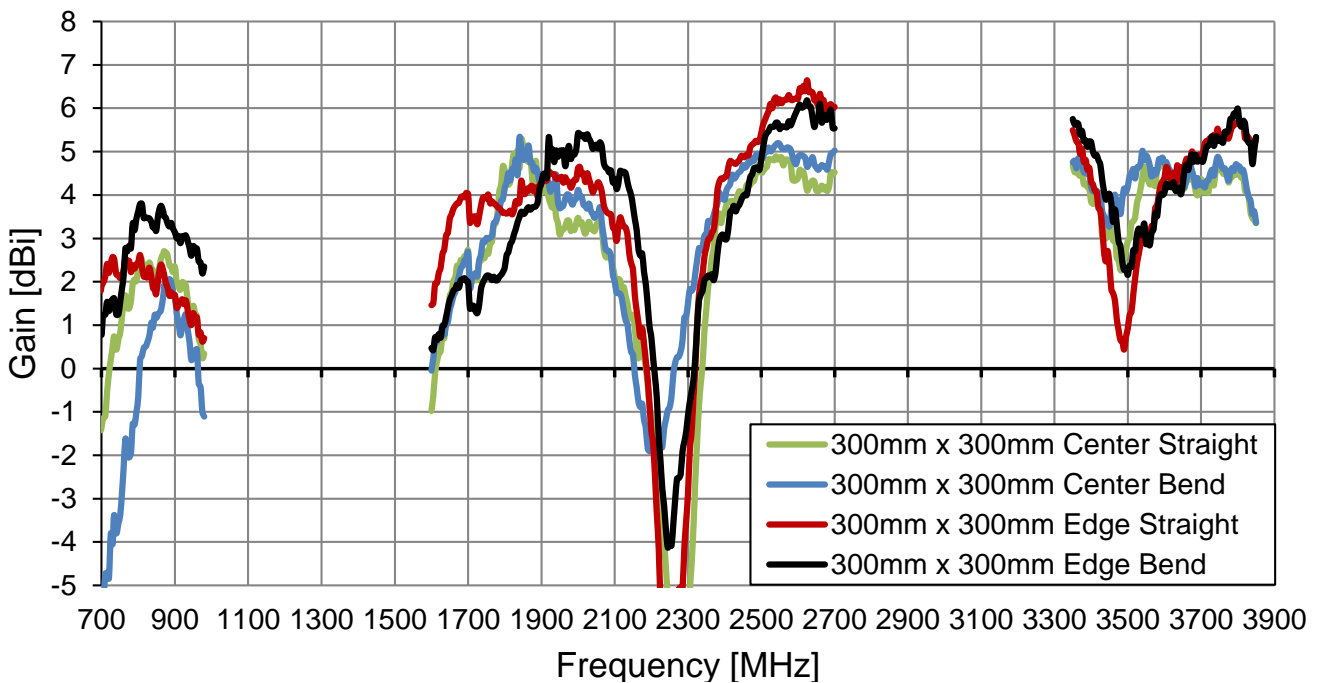
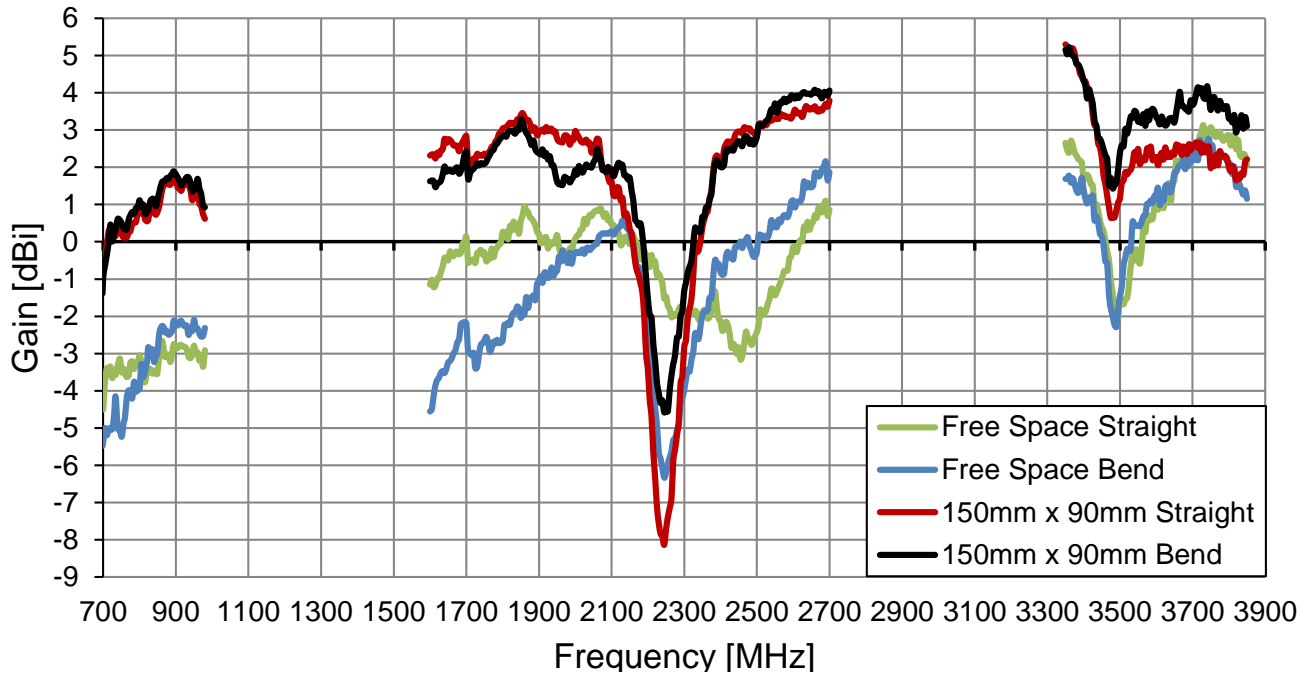

### 3.5 Average Gain

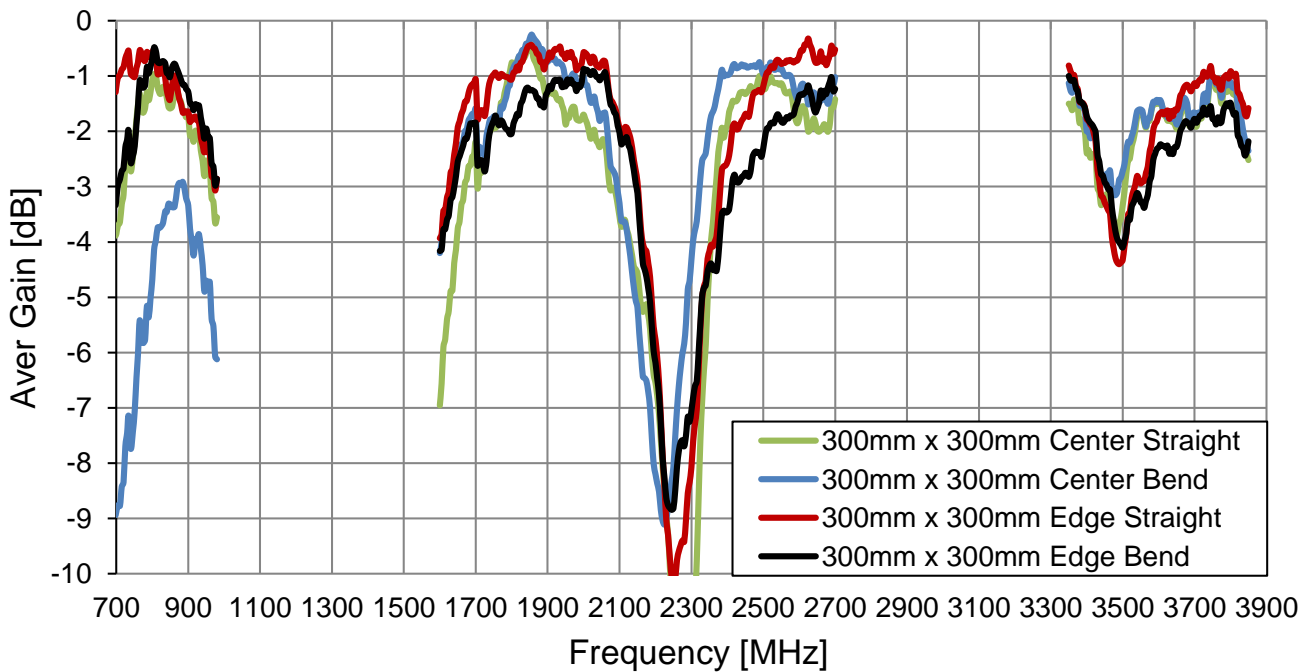
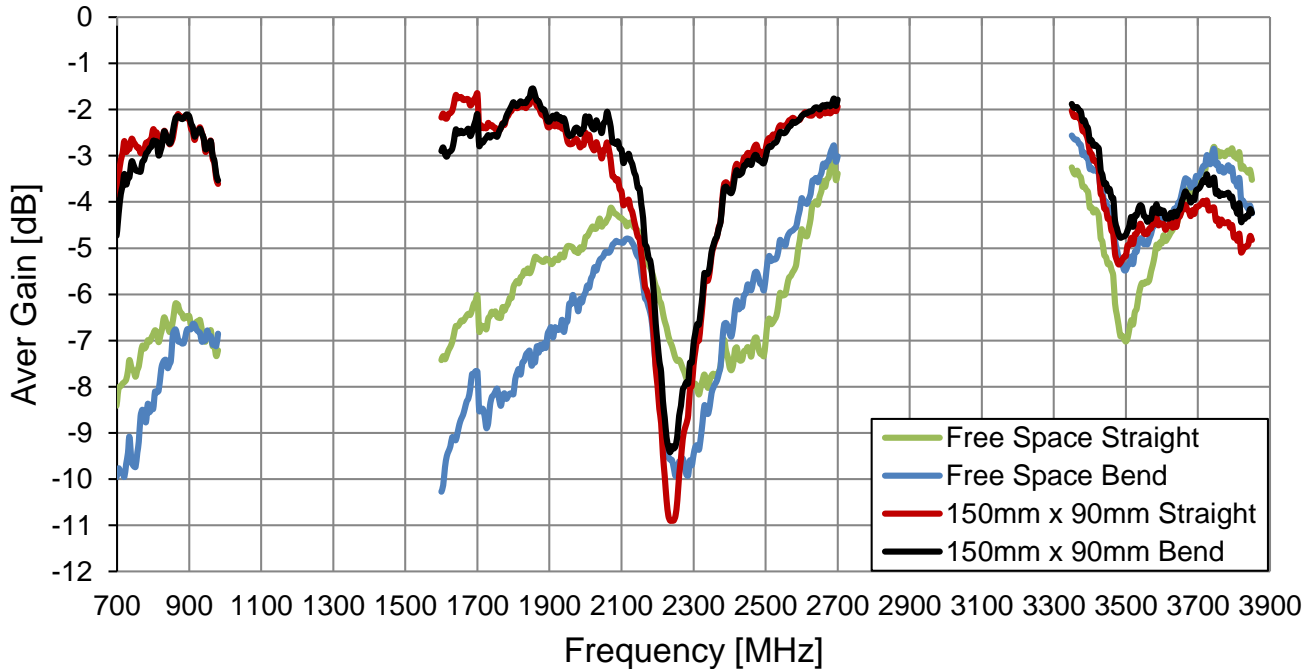

# 4. Radiation Patterns

## 4.1 Free Space – Straight 3D and 2D Radiation Patterns

704-960MHz

Azimuth = 0.0  
Elevation = 0.0  
Roll = -45.0

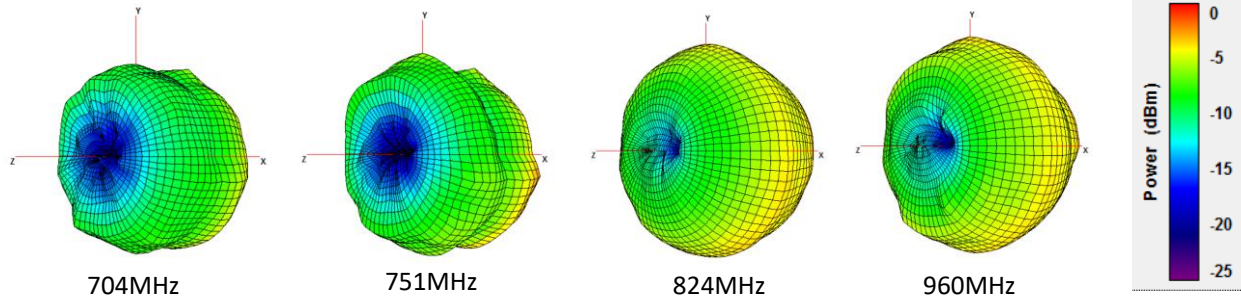

XY Plane

XZ Plane

YZ Plane

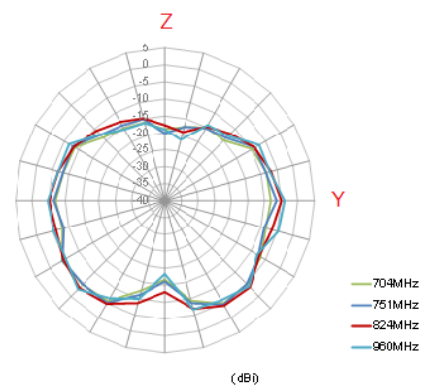
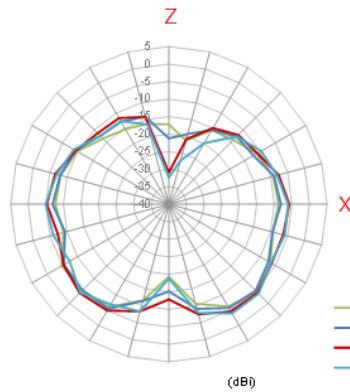
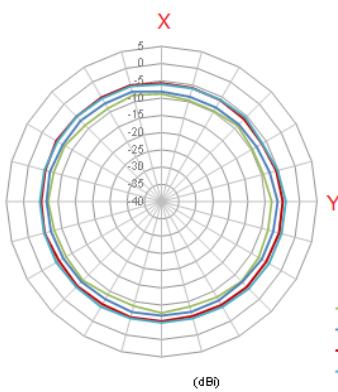

## 1710-2170MHz

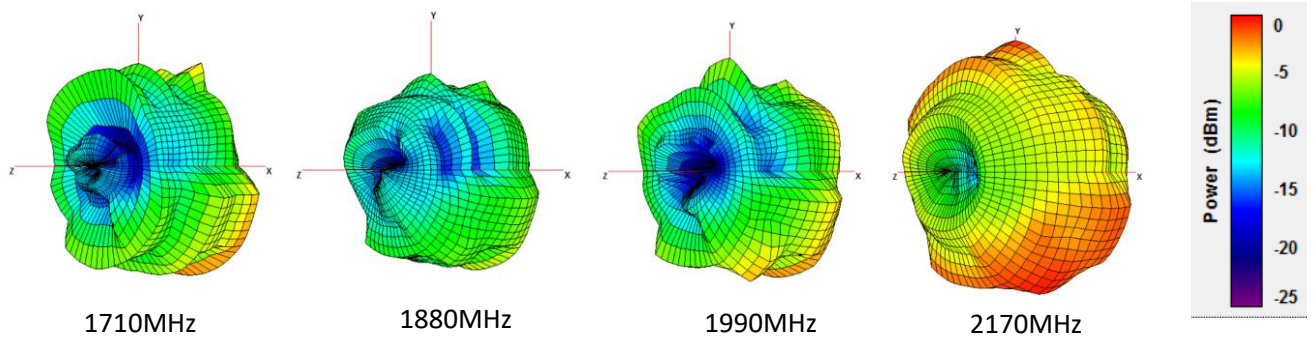

XY Plane
XZ Plane
YZ Plane

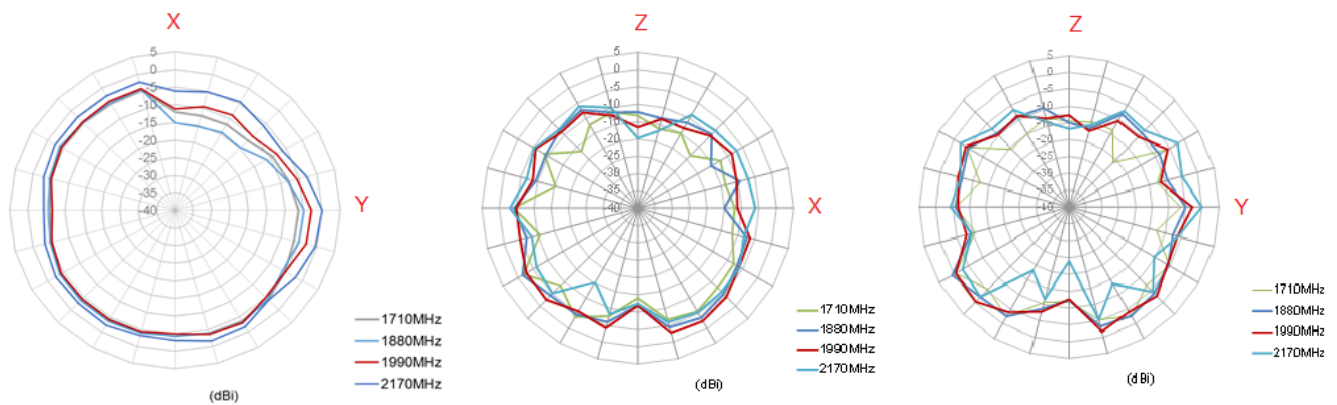

## 2300-3600MHz

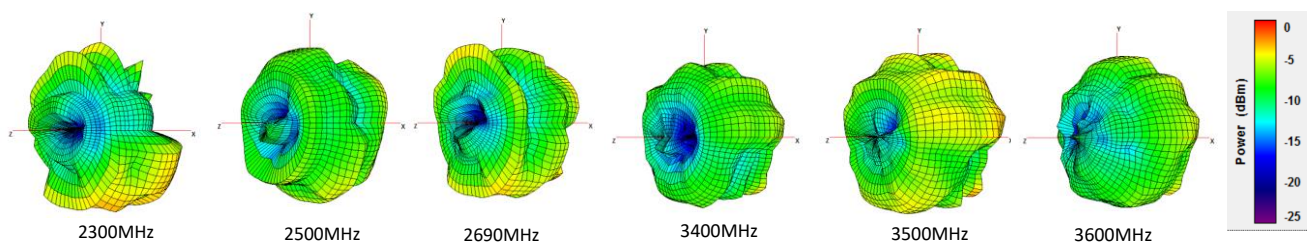

XY Plane
XZ Plane
YZ Plane

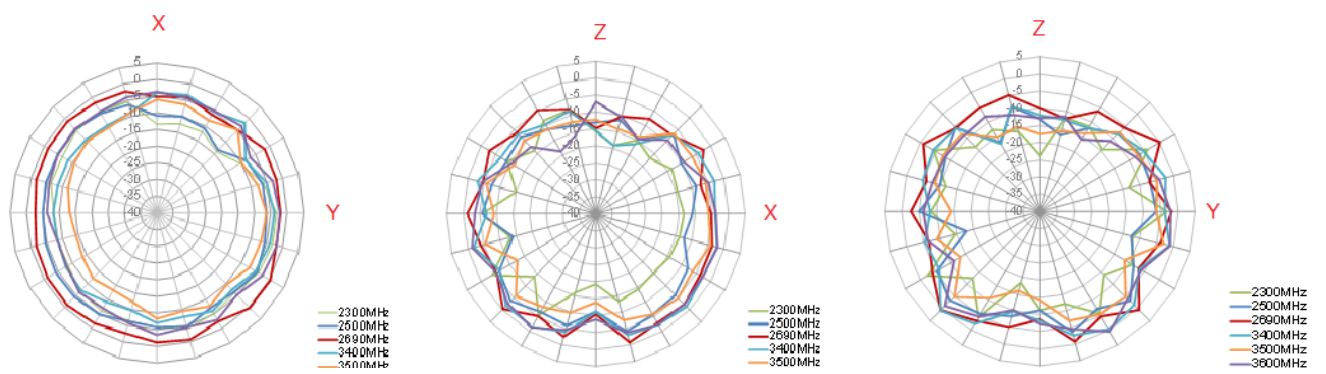

## 4.2 Free Space – Bent 3D and 2D Radiation Patterns

704-960MHz

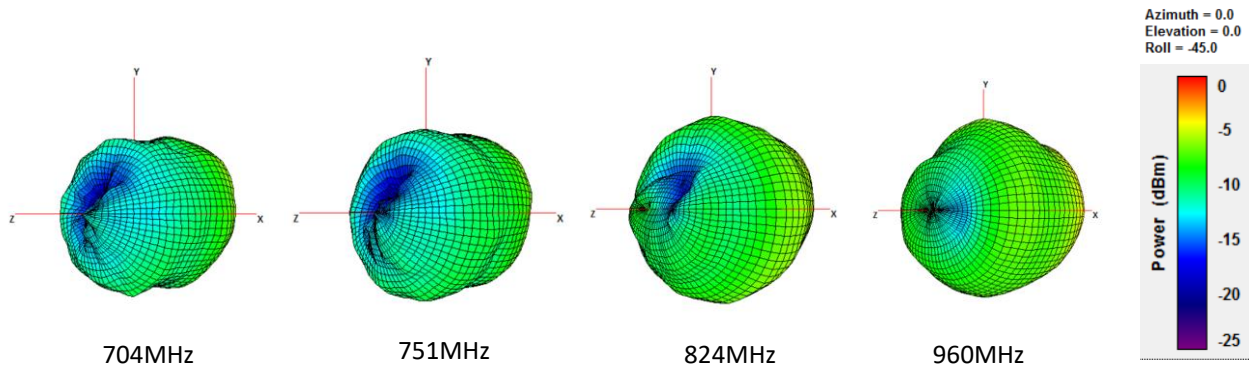

XY Plane

XZ Plane

YZ Plane

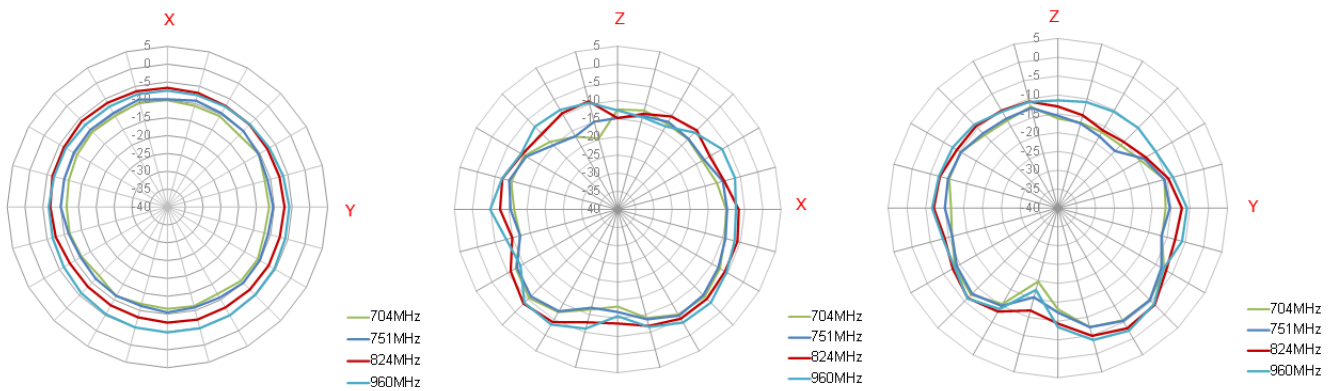

## 1710-2170MHz

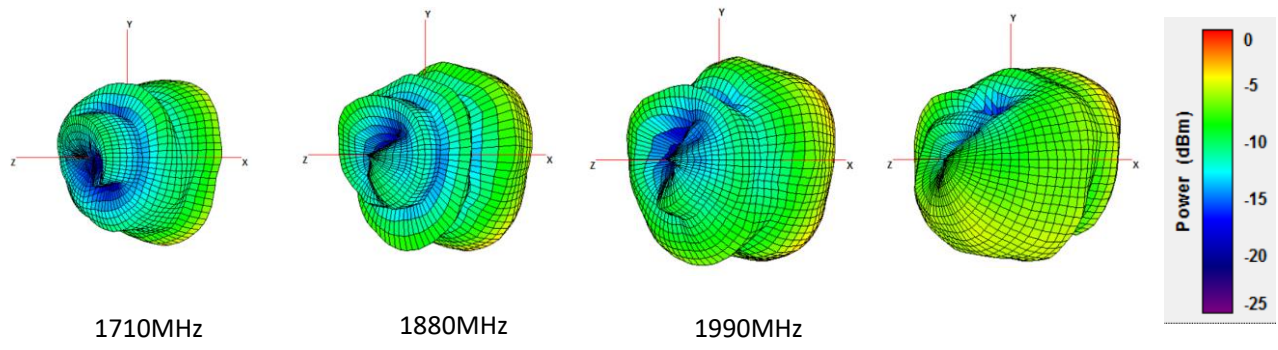

### XY Plane

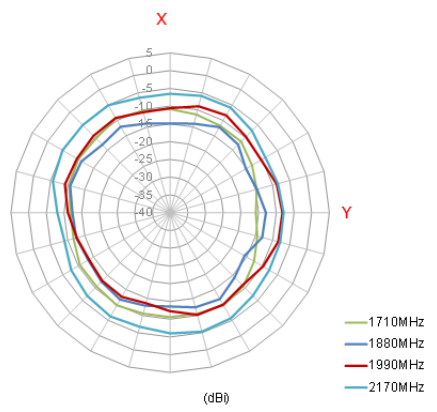

### XZ Plane

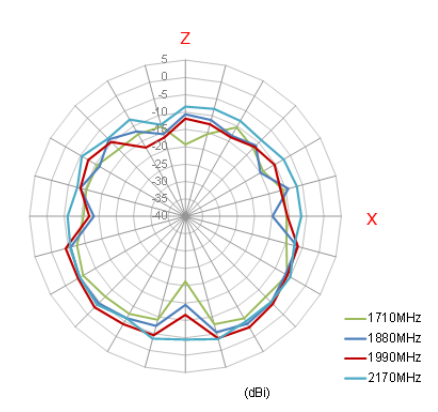

### YZ Plane

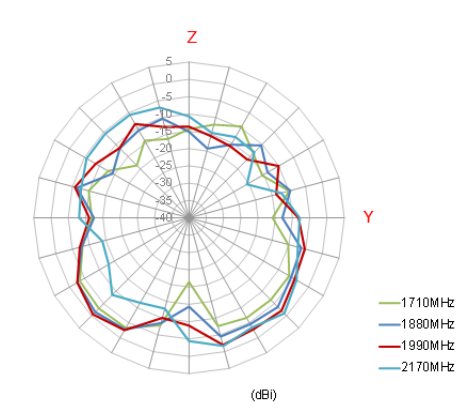

## 2300-3600MHz

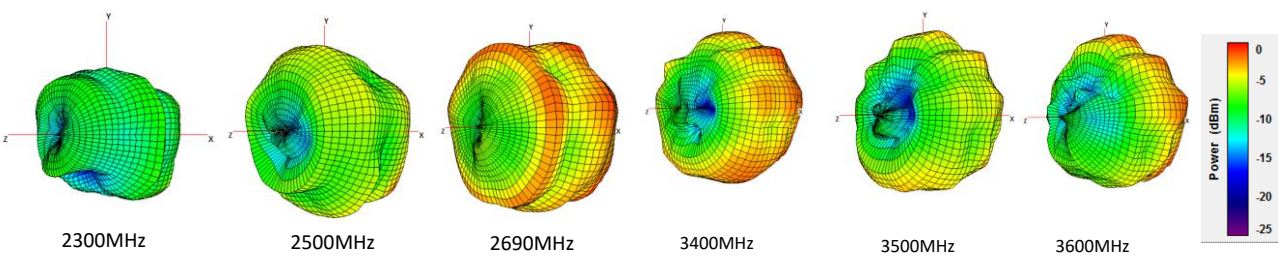

### XY Plane

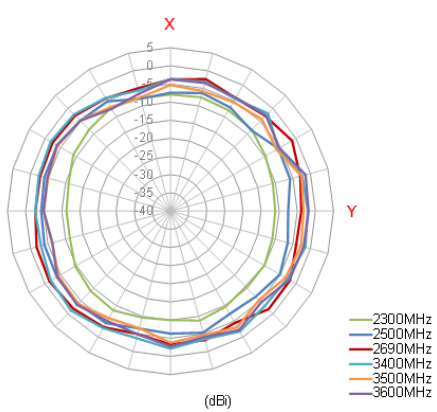

### XZ Plane

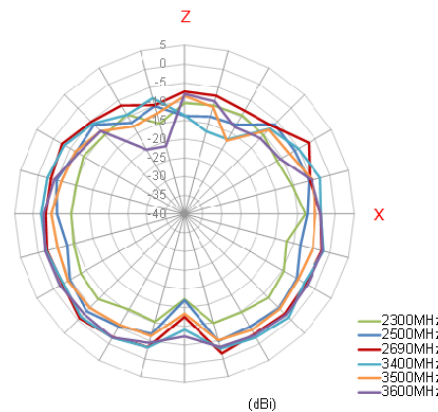

### YZ Plane

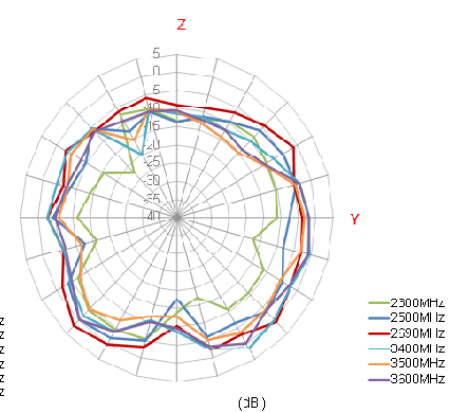

### 4.3 150\*90mm – Straight 3D and 2D Radiation Patterns

#### 704-960MHz

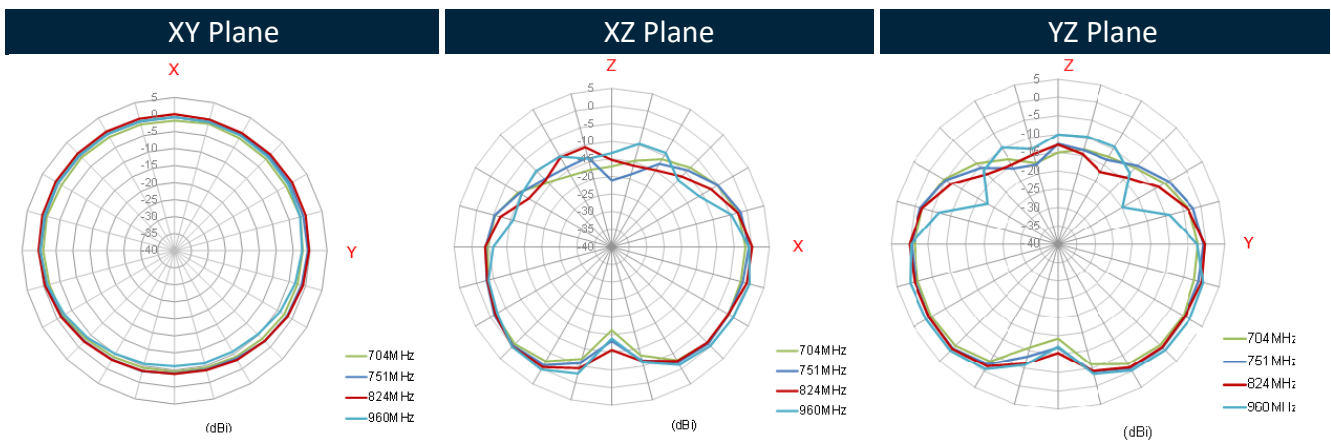
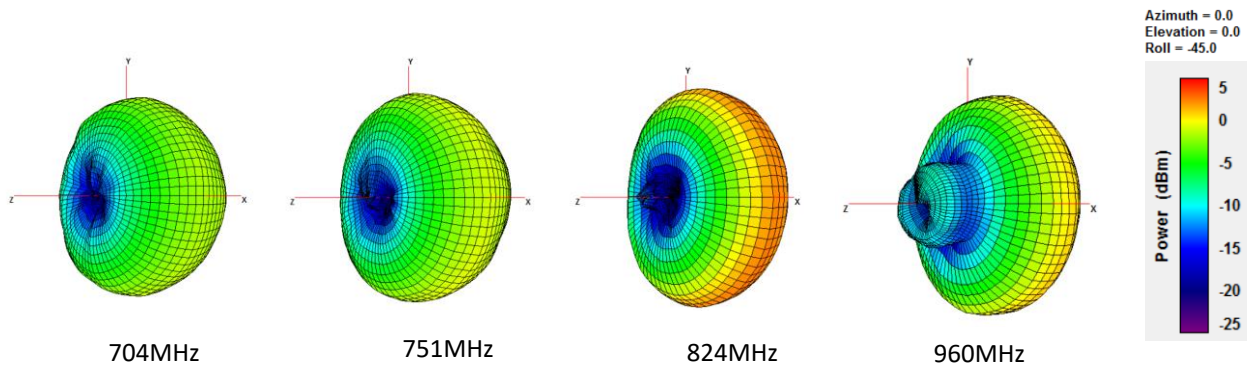



**1710-2170MHz**

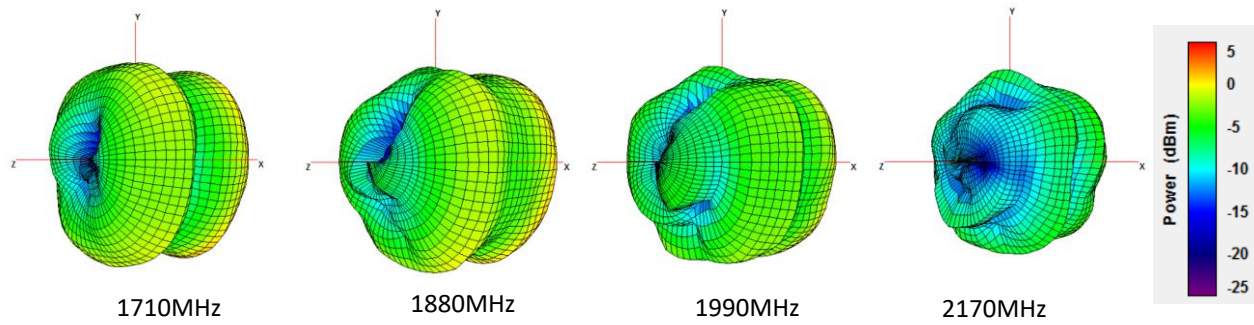

**XY Plane**

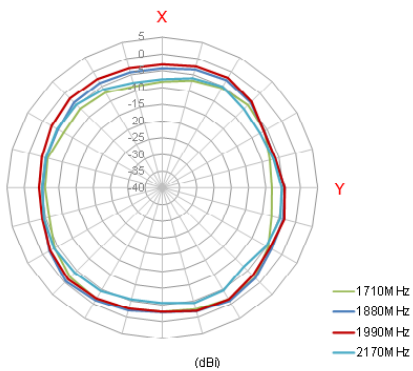

**XZ Plane**

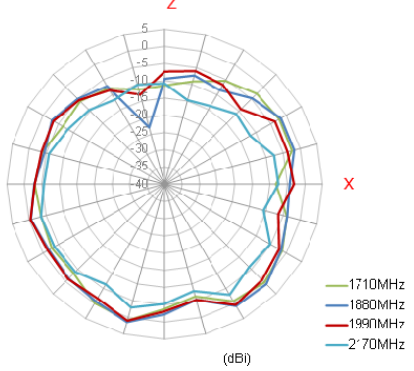

**YZ Plane**

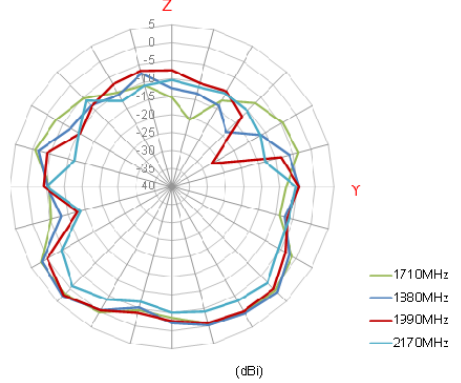

**2300-3600MHz**

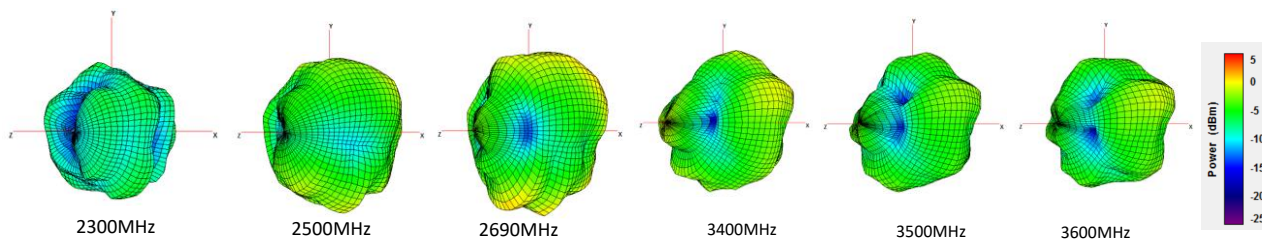

**XY Plane**

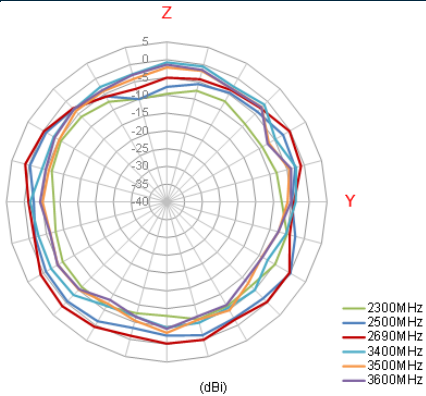

**XZ Plane**

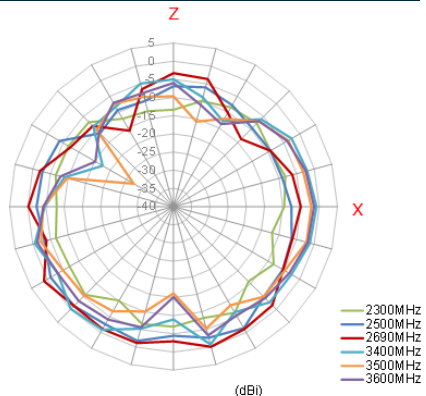

**YZ Plane**

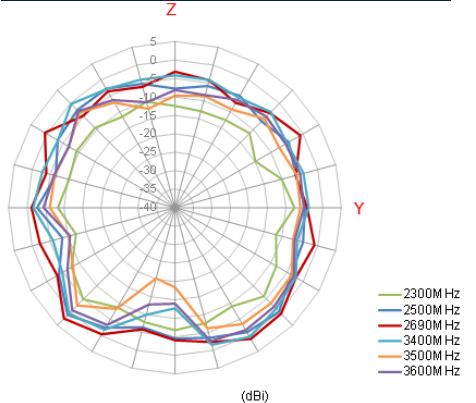

4.4 150\*90mm – Bent3D and 2D Radiation Patterns

704-960MHz

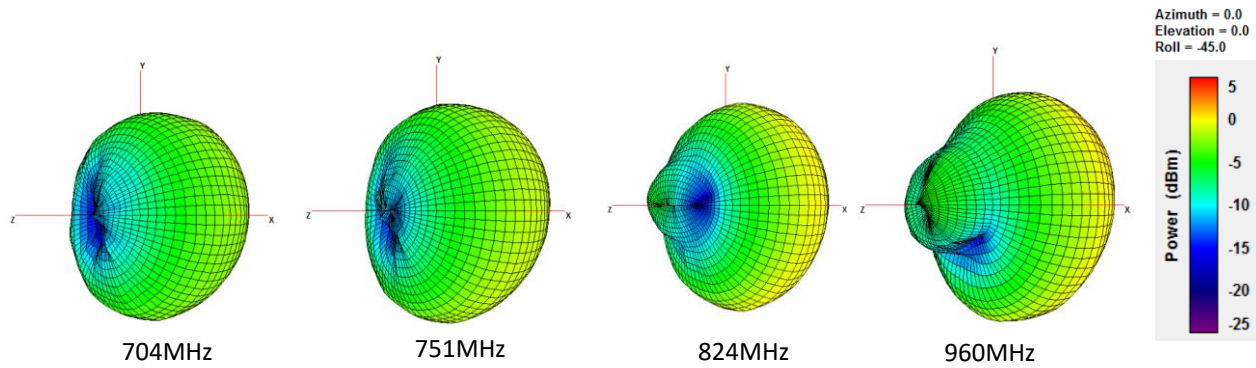

XY Plane

XZ Plane

YZ Plane

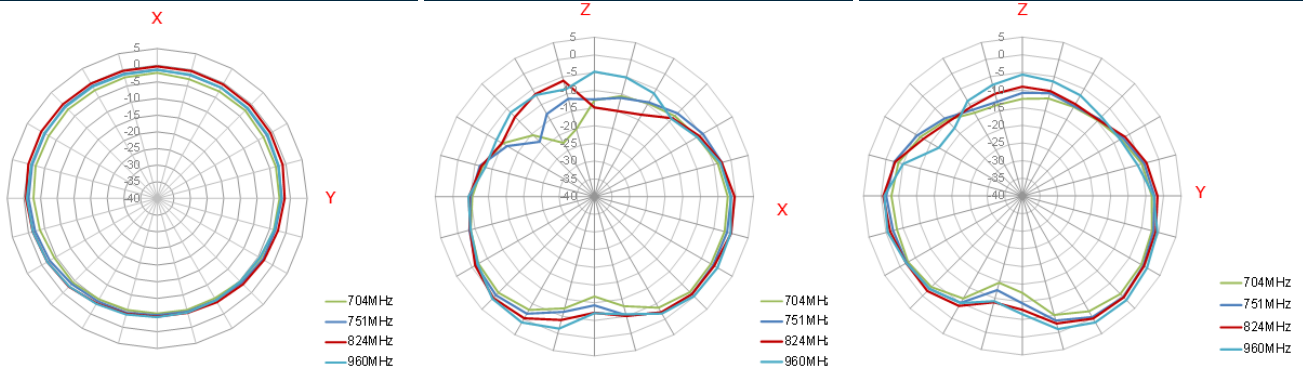

## 1710-2170MHz

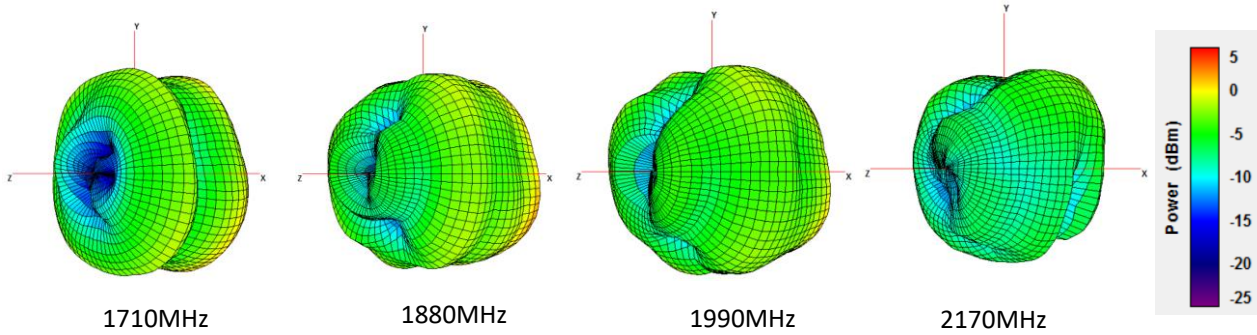

### XY Plane

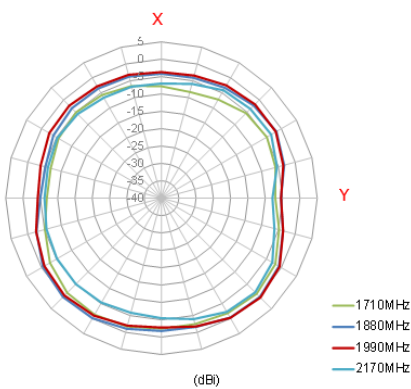

### XZ Plane

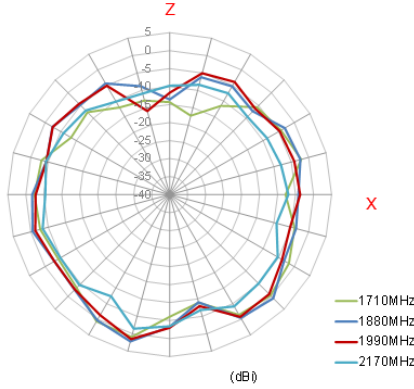

### YZ Plane

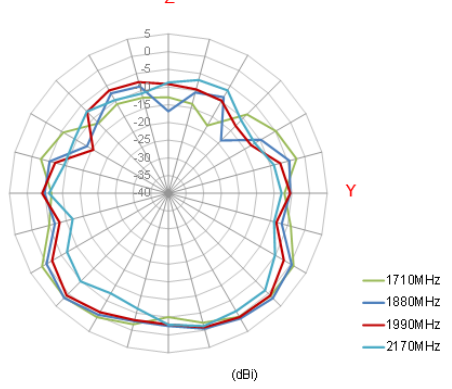

## 2300-3600MHz

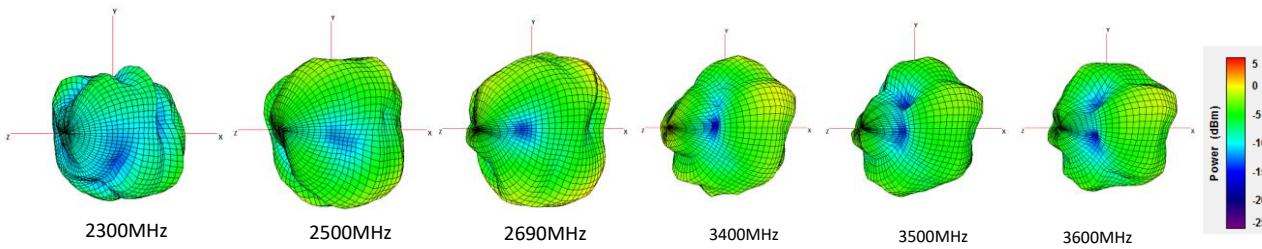

### XY Plane

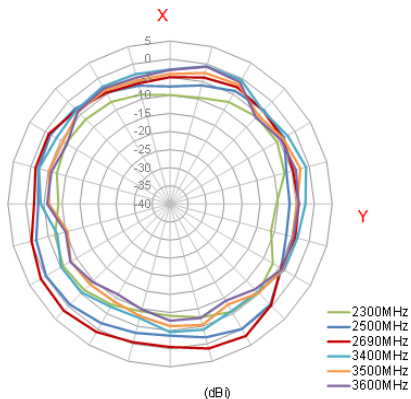

### XZ Plane

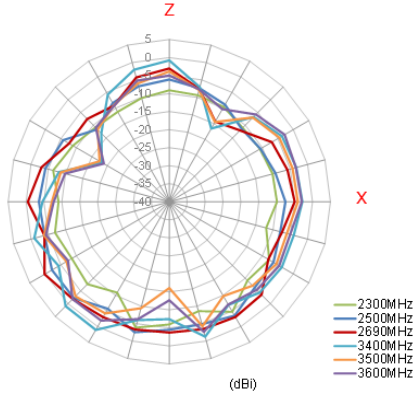

### YZ Plane

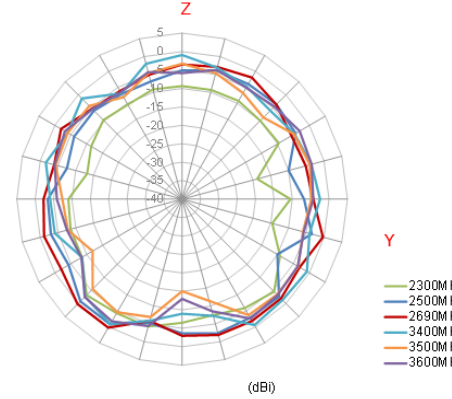

## 4.5 300\*300mm Center – Straight 3D and 2D Radiation Patterns

### 704-960MHz

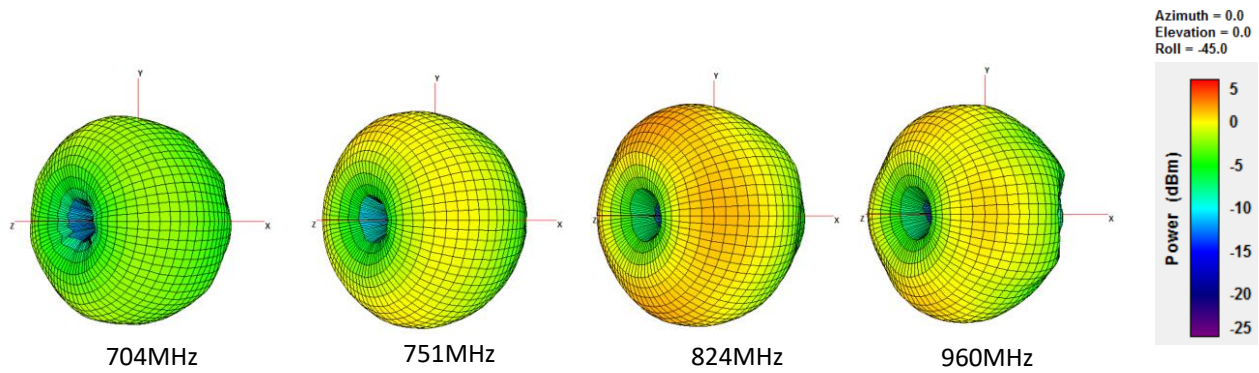

XY Plane

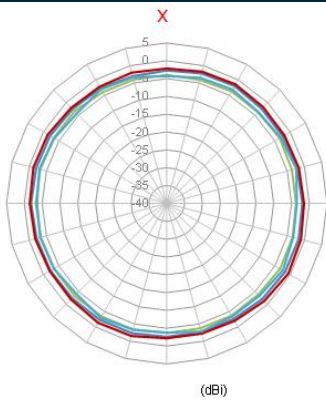

— 704MHz  
 — 751MHz  
 — 824MHz  
 — 960MHz

XZ Plane

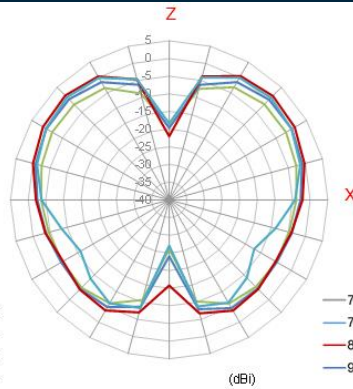

— 704MHz  
 — 751MHz  
 — 824MHz  
 — 960MHz

YZ Plane

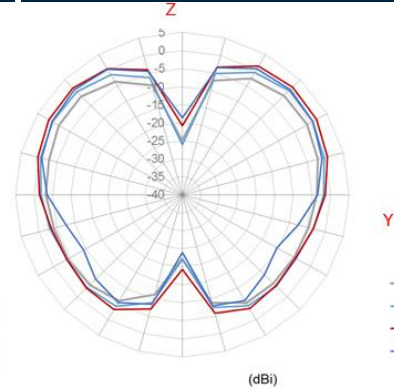

— 704MHz  
 — 751MHz  
 — 824MHz  
 — 960MHz

## 1710-2170MHz

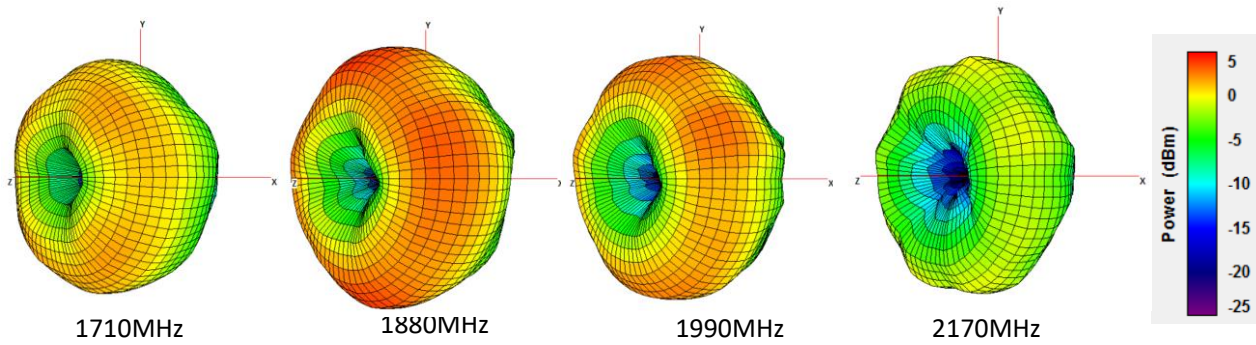

### XY Plane

### XZ Plane

### YZ Plane

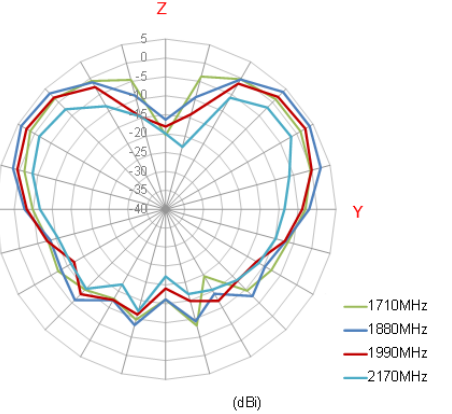
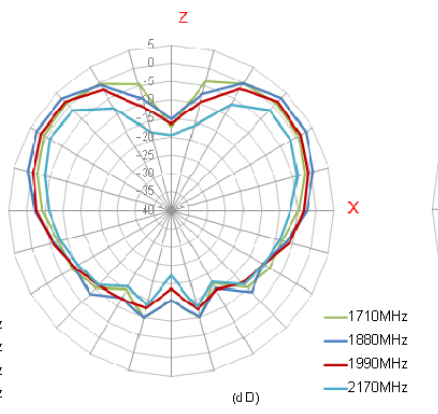
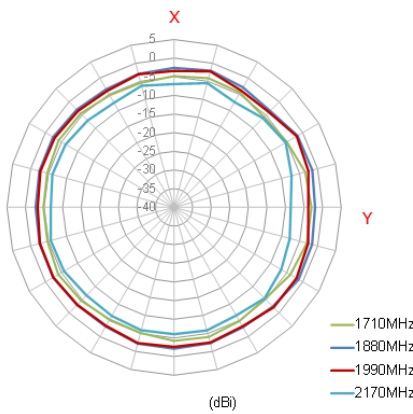

## 2300-3600MHz

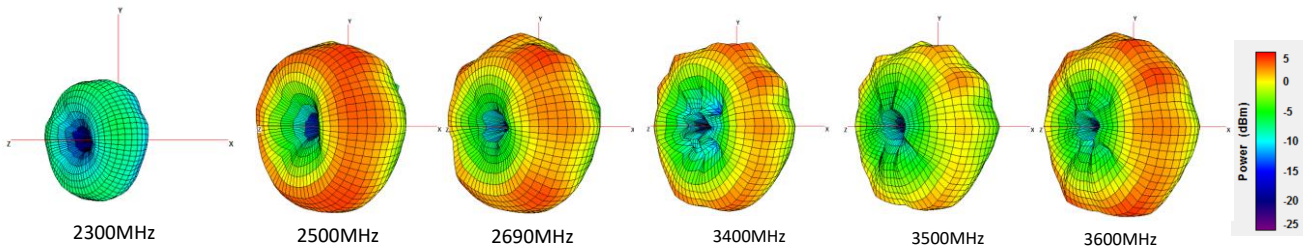

### XY Plane

### XZ Plane

### YZ Plane

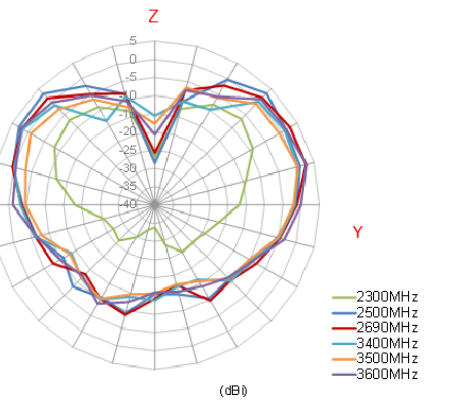
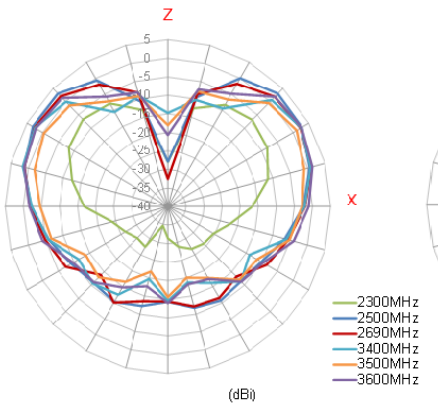
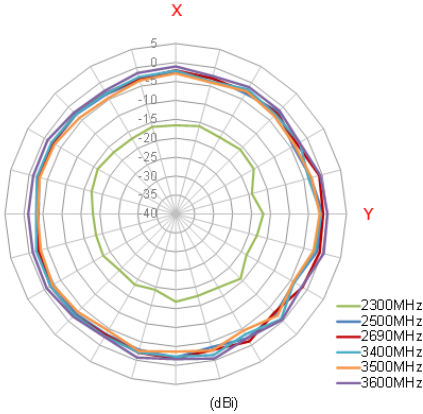

4.6 300\*300mm Center – Bent 3D and 2D Radiation Patterns

704-960MHz

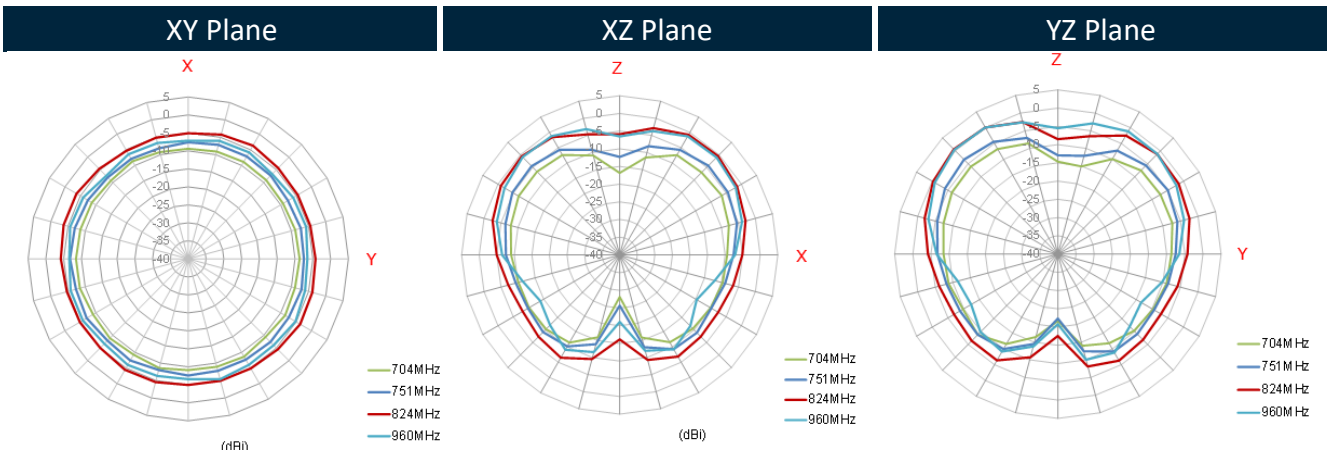
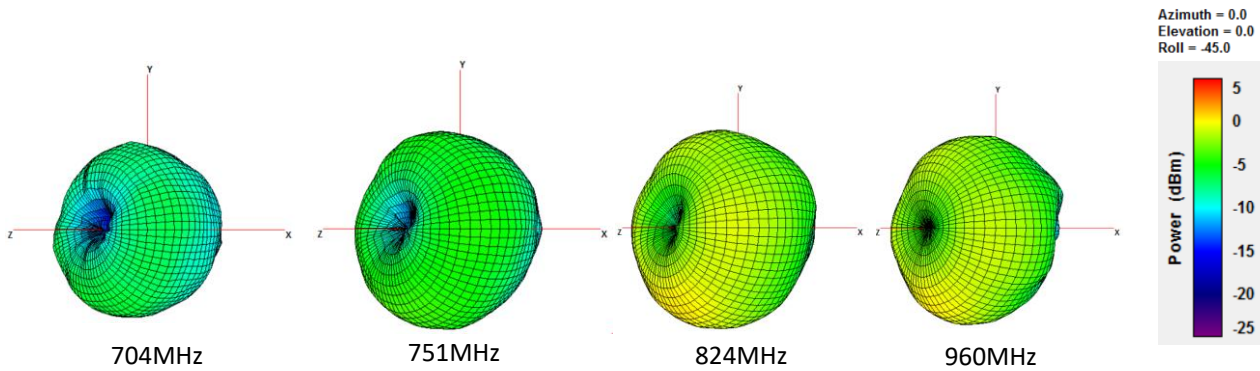

1710-2170MHz

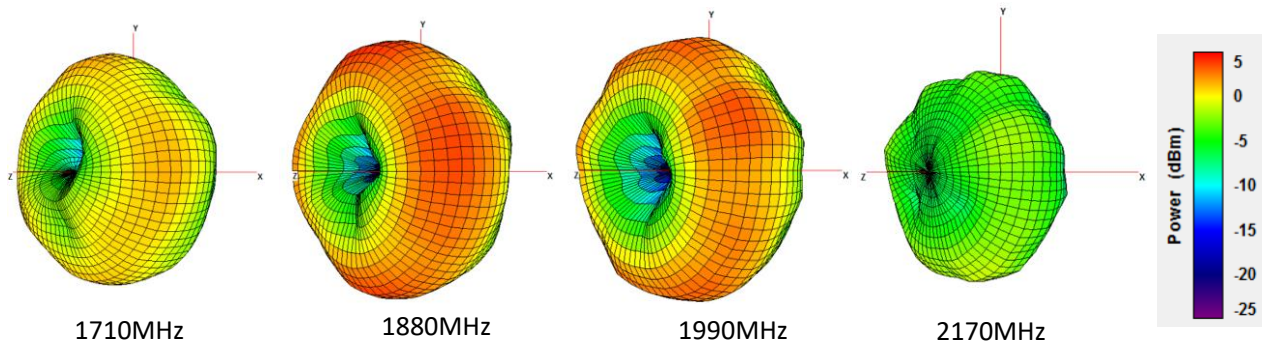

XY Plane

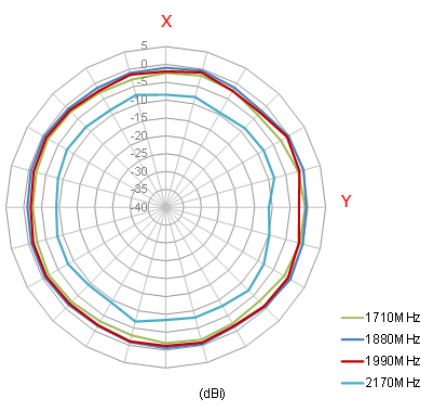

XZ Plane

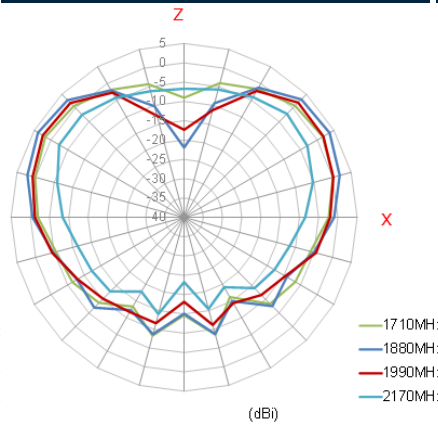

YZ Plane

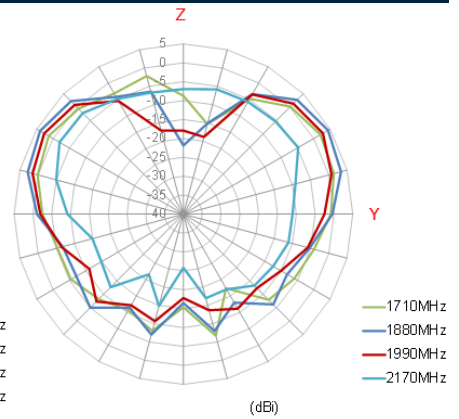

2300-3600MHz

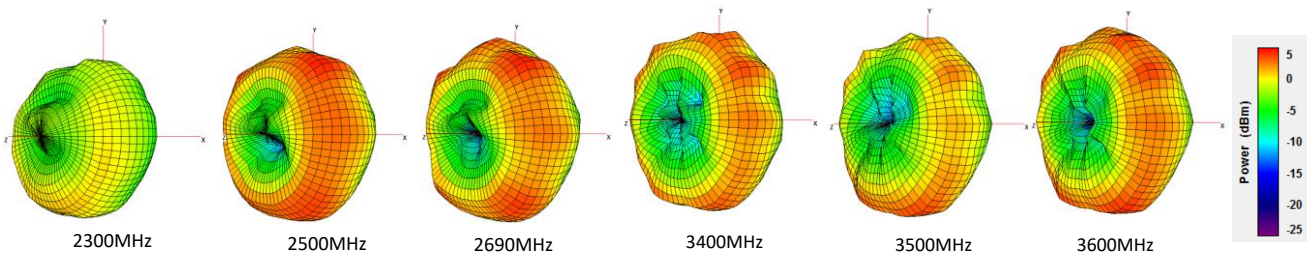

XY Plane

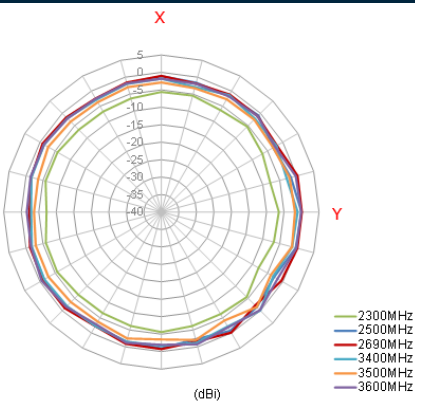

XZ Plane

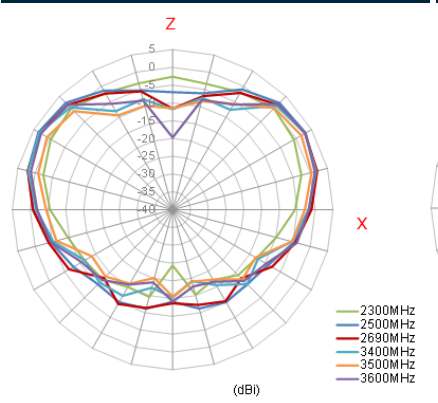

YZ Plane

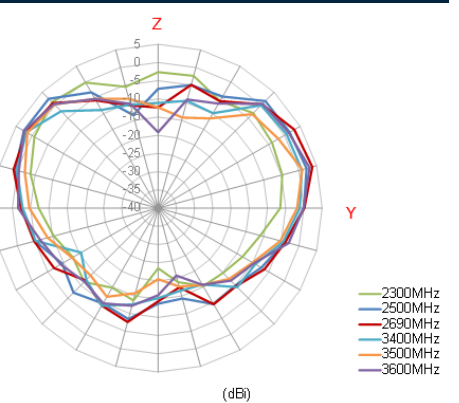

4.7 300\*300mm Edge – Straight 3D and 2D Radiation Patterns

704-960MHz

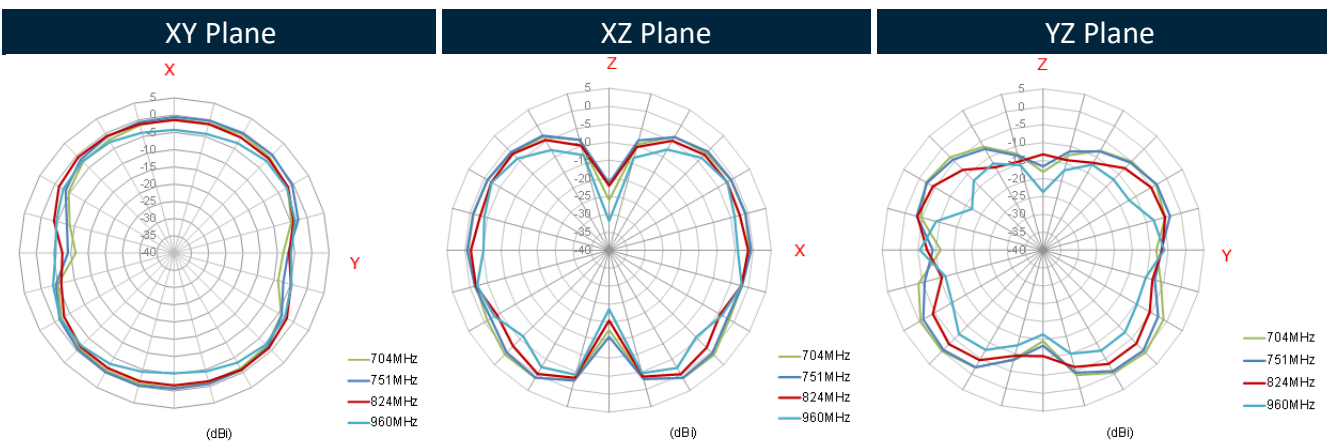
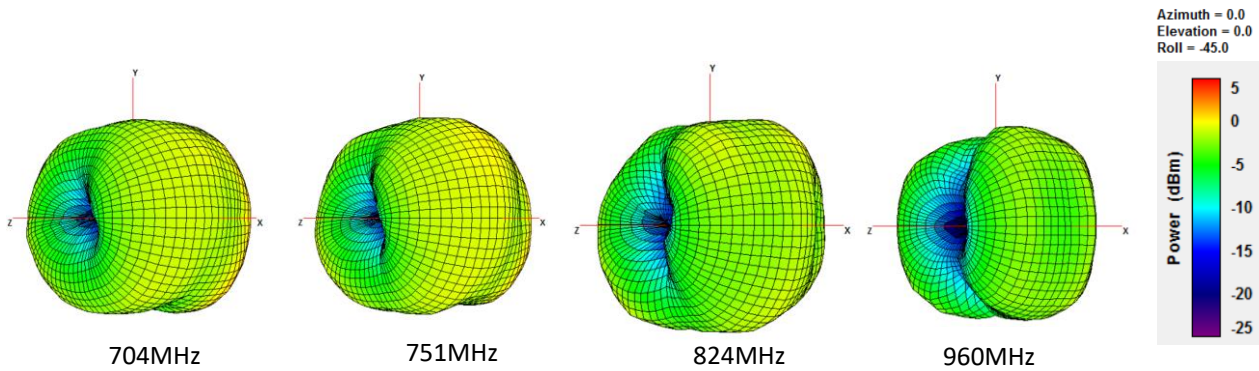



**1710-2170MHz**

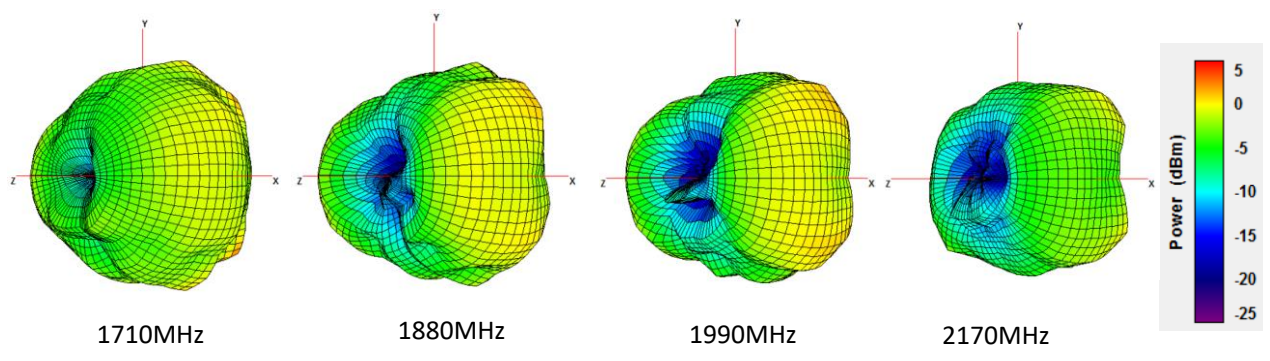

**XY Plane**

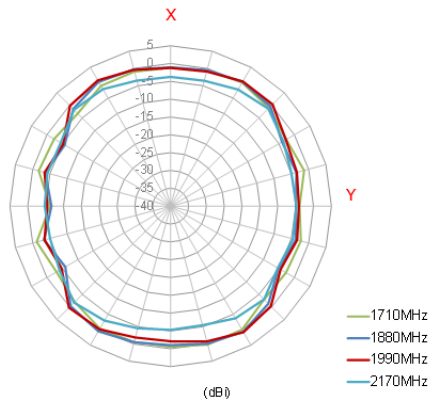

**XZ Plane**

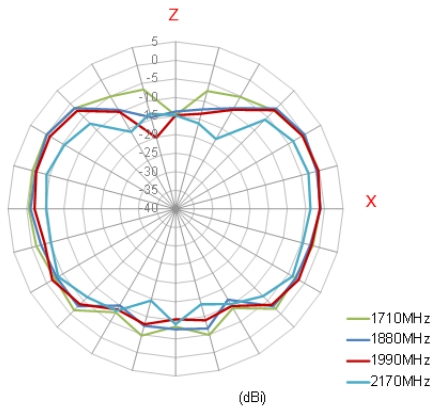

**YZ Plane**

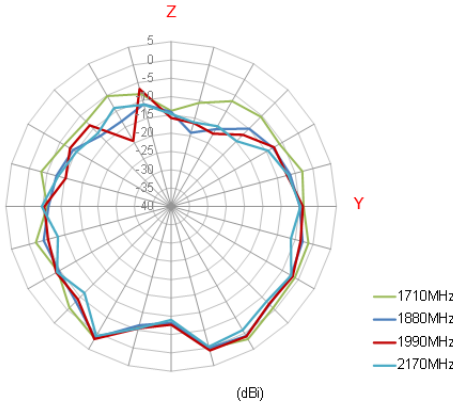

**2300-3600MHz**

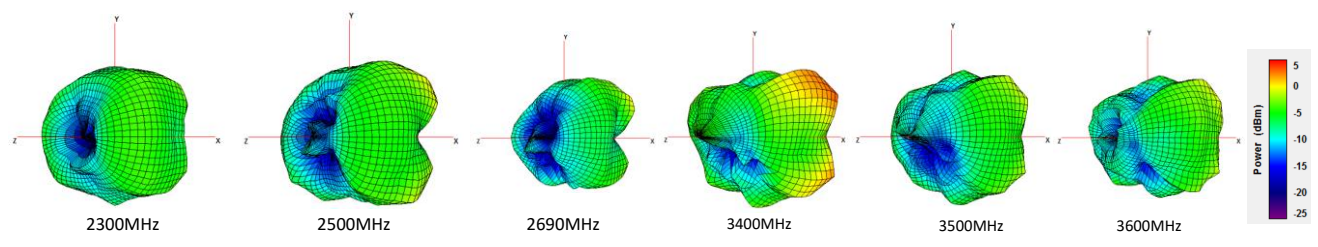

**XY Plane**

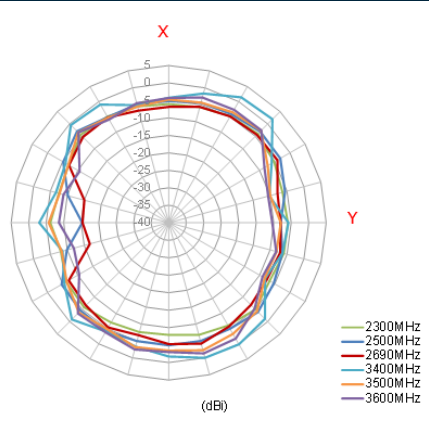

**XZ Plane**

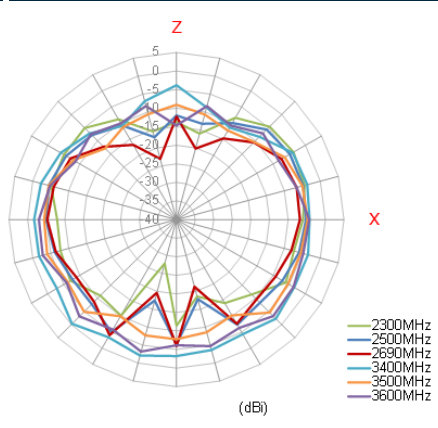

**YZ Plane**

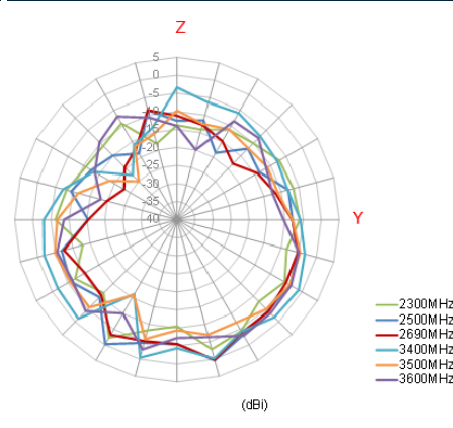

4.8 300\*300mm Edge – Bent 3D and 2D Radiation Patterns

704-960MHz

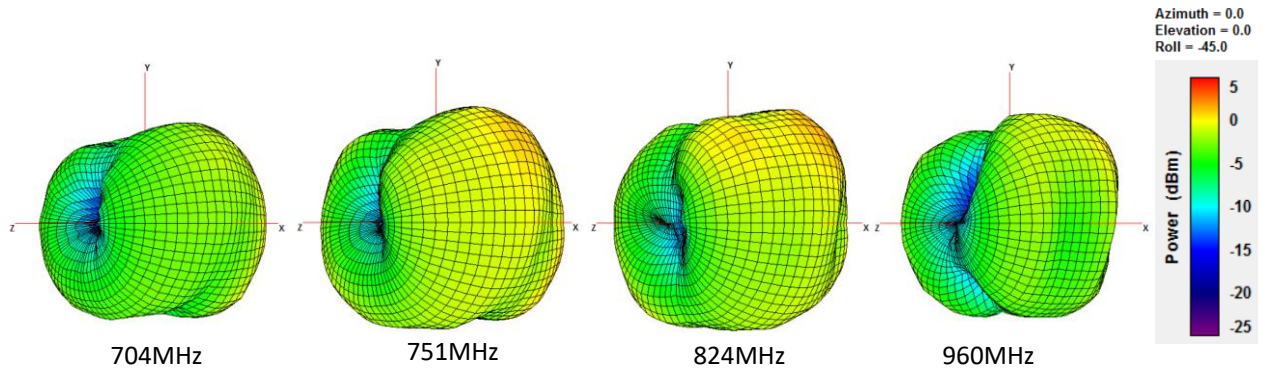

XY Plane

XZ Plane

YZ Plane

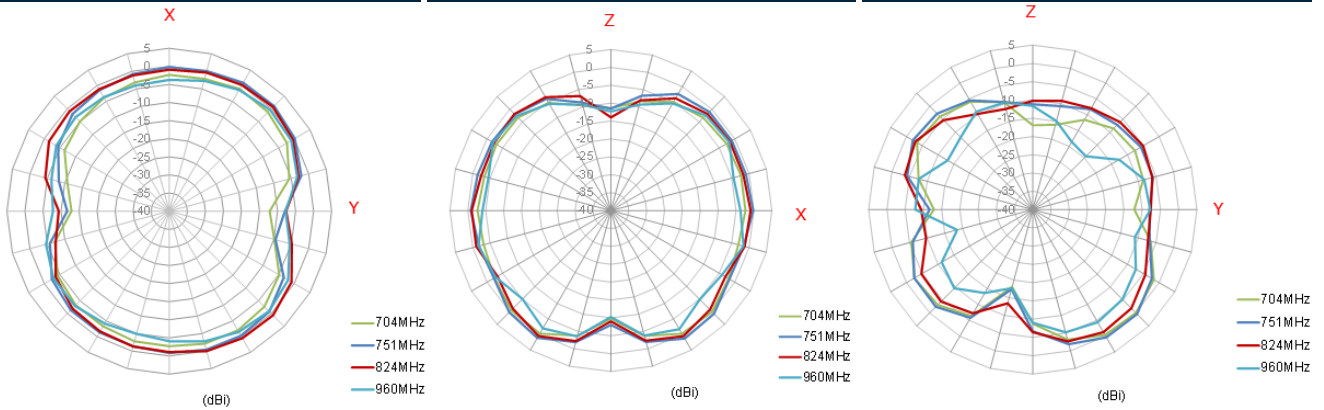

## 1710-2170MHz

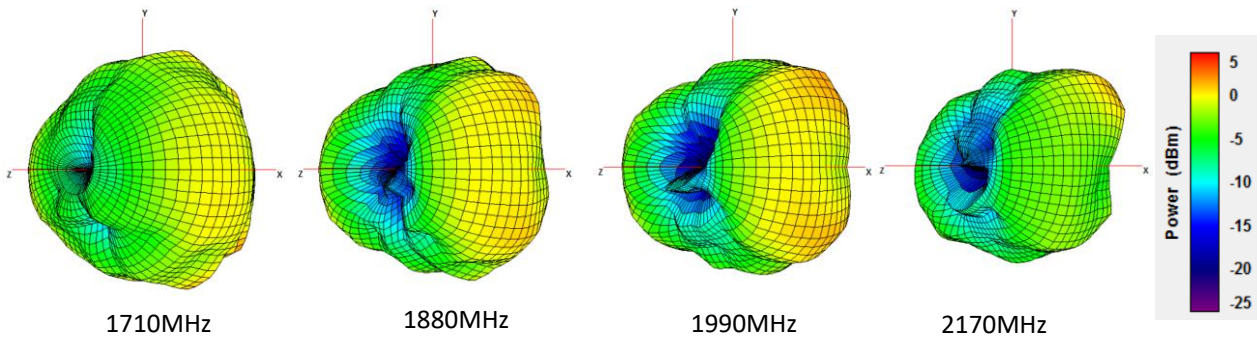

### XY Plane

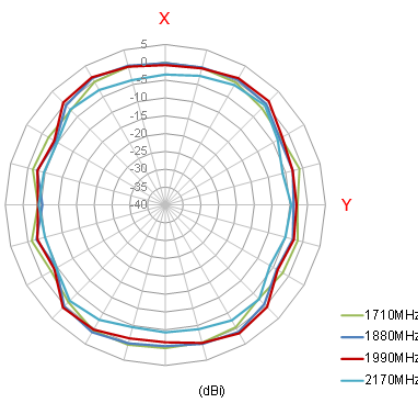

### XZ Plane

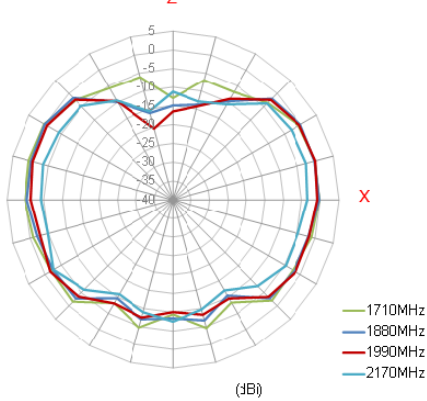

### YZ Plane

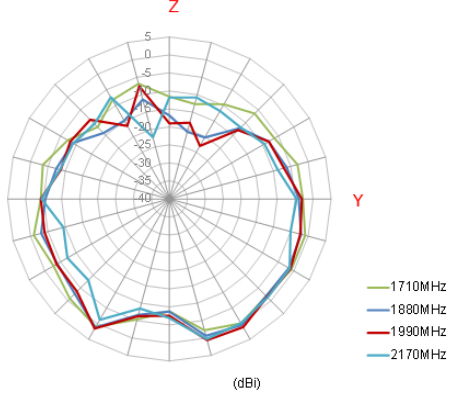

## 2300-3600MHz

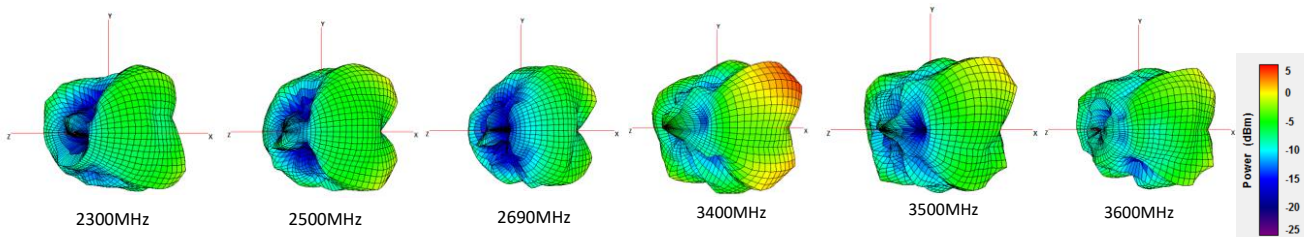

### XY Plane

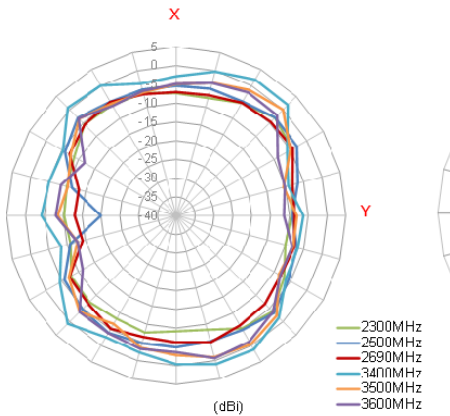

### XZ Plane

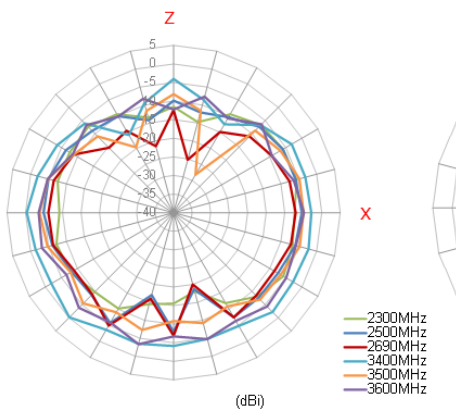

### YZ Plane

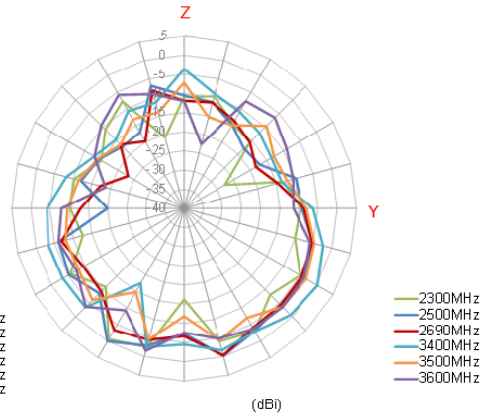

# 5. Mechanical Drawing (Units: mm)

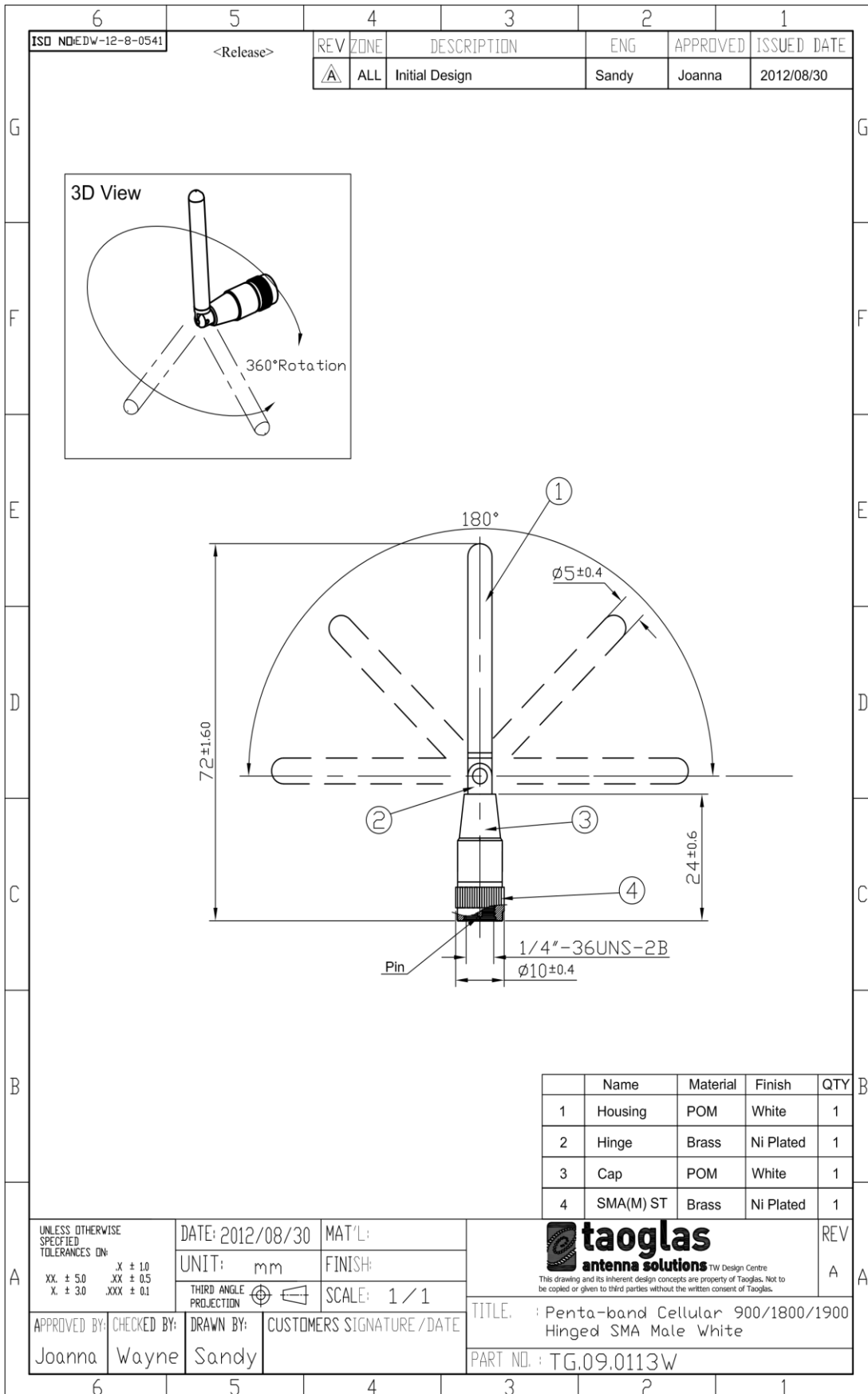

## 6. Installation

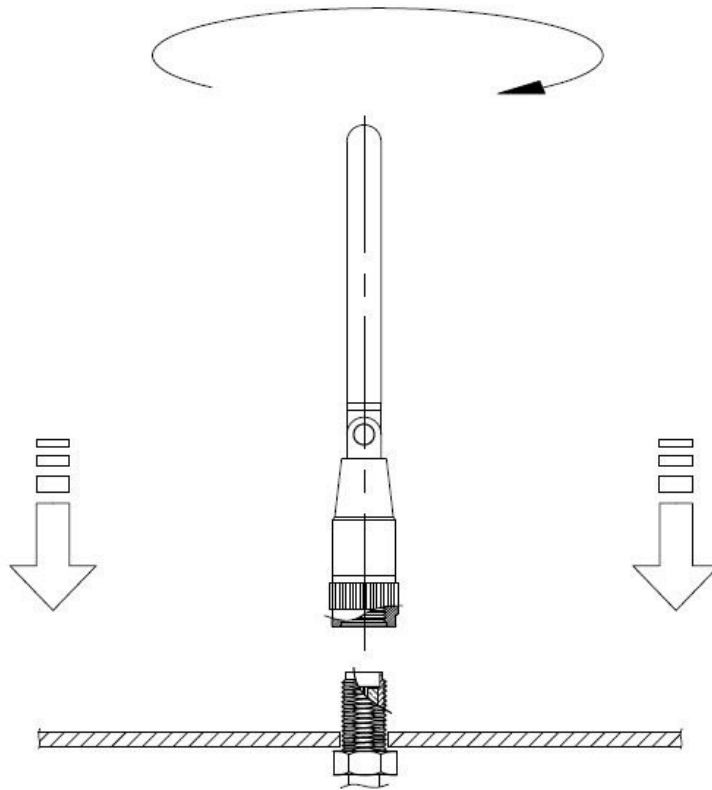

Recommended torque for mounting is 0.9 N·m  
Maximum torque for mounting is 1.176 N·m

## 7. Packaging

1 pcs TG.09.0113W per PE bag  
 PE Bag Dimensions - 74 x 42mm  
 Weight - 8.6g

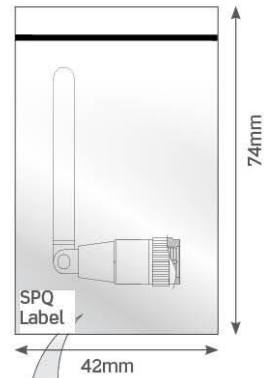

100 pcs TG.09.0113W per large PE bags  
 Large PE bags Dimensions - 280 x 180mm  
 Weight - 0.88kg

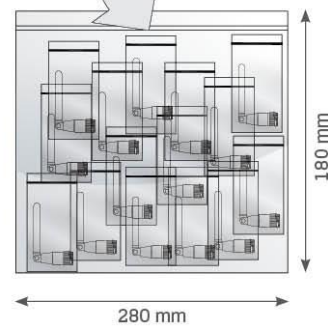

1500 pcs TG.09.0113W per carton  
 Carton Dimensions - 360 x 310 x 160mm  
 Weight - 13.5kg

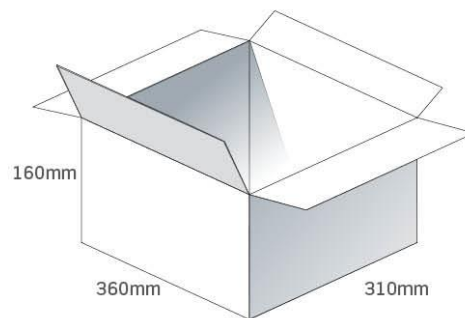

Pallet Dimensions 1200\*1000\*1480mm  
 72 Cartons per Pallet  
 9 Cartons per layer  
 8 Layers

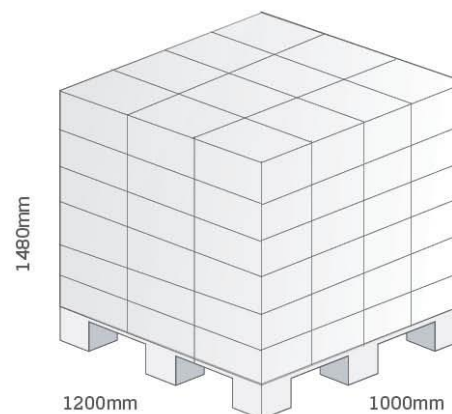

## 8. Application Note

Different Ground Plane lengths were considered for acceptable efficiency for LTE bands.

Three different ground planes were chosen. They were all 30mm wide and the lengths were varied beginning at 90mm then 70mm and finally 60mm

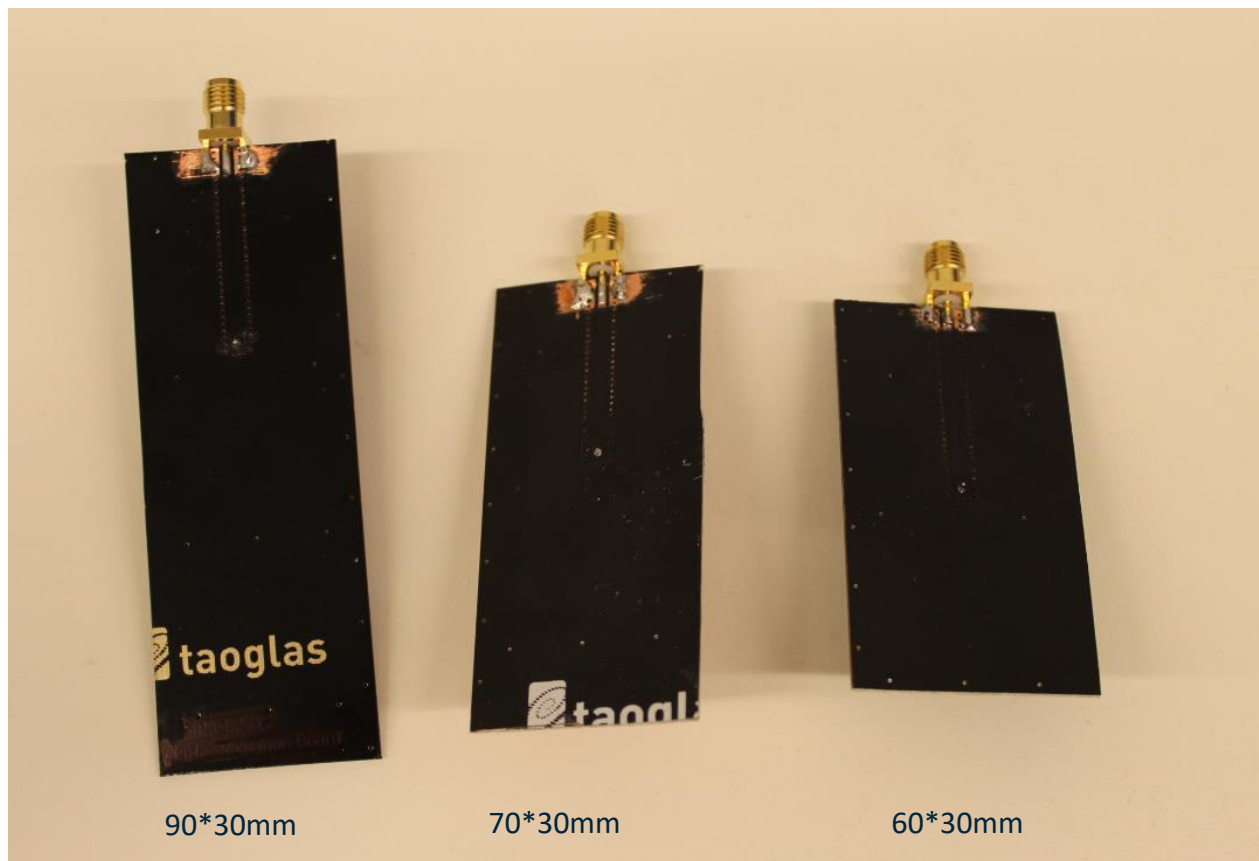

It was also considered whether the TG.09 antenna was positioned straight or at an angle of 90°. The antenna was positioned on the edge of the Ground Plane for all tests.

Parameter									
Straight Pose									
Frequency (MHz)		703~ 803	824~ 960	1710~ 1880	1850~ 1990	1920~ 2170	2300~ 2400	2490~ 2690	3300~ 3800
Average Gain (dBi)	90mm x 30mm Ground	-1.4	-3.2	-3.2	-1.9	-2.3	-5.1	-2.0	-3.8
Efficiency (%)		72%	49%	48%	64%	59%	31%	63%	42%
Peak Gain (dBi)		2.0	1.9	2.7	3.2	3.6	1.3	5.2	2.7
Return Loss (dB)		9	4.8	5.1	11.4	11.1	5.3	9.6	9.5
Average Gain (dBi)	70mm x 30mm Ground	-2.7	-2.7	-3.4	-2.2	-1.8	-5.7	-1.5	-3.9
Efficiency (%)		53%	54%	45%	60%	67%	28%	70%	42%
Peak Gain (dBi)		1.8	2.0	1.5	3.5	4.3	1.7	4.3	3.7
Return Loss (dB)		7.3	7.1	4.2	7.3	12.4	4.4	14.7	8.9
Average Gain (dBi)	60mm x 30mm Ground	-3.9	-2.9	-2.9	-2.4	-1.6	-7.3	-1.4	-4.3
Efficiency (%)		41%	50%	51%	58%	69%	20%	72%	37%
Peak Gain (dBi)		1.1	1.3	2.1	3.0	4.1	0.4	4.5	3.0
Return Loss (dB)		6.5	7.7	5.0	6.4	9.9	3.4	12.4	6.3
90° Bend Pose									
Average Gain (dBi)	90mm x 30mm Ground	-1.7	-2.4	-3.5	-2.1	-2.1	-5.3	-2.1	-3.3
Efficiency (%)		68%	58%	45%	61%	61%	30%	61%	47%
Peak Gain (dBi)		2.7	2.5	2.1	3.1	3.5	1.6	5.2	3.4
Return Loss (dB)		7.5	7.6	4.5	9.1	12.5	5.1	8.7	12.3
Average Gain (dBi)	70mm x 30mm Ground	-4.2	-2.3	-3.7	-2.5	-1.8	-4.6	-1.5	-3.4
Efficiency (%)		39%	59%	42%	56%	67%	35%	70%	46%
Peak Gain (dBi)		1.4	1.7	1.4	3.2	4.3	2.1	4.1	4.1
Return Loss (dB)		4.9	11.2	3.9	6.4	13.5	5.2	12.6	10.6
Average Gain (dBi)	60mm x 30mm Ground	-5.6	-3.0	-3.2	-2.6	-1.7	-5.9	-1.4	-3.9
Efficiency (%)		28%	50%	47%	54%	68%	26%	73%	41%
Peak Gain (dBi)		0.0	1.0	1.8	3.0	3.8	1.1	4.3	3.3
Return Loss (dB)		4.4	11.5	4.6	6.0	10.8	3.9	11.2	7.0



8.1 Return Loss

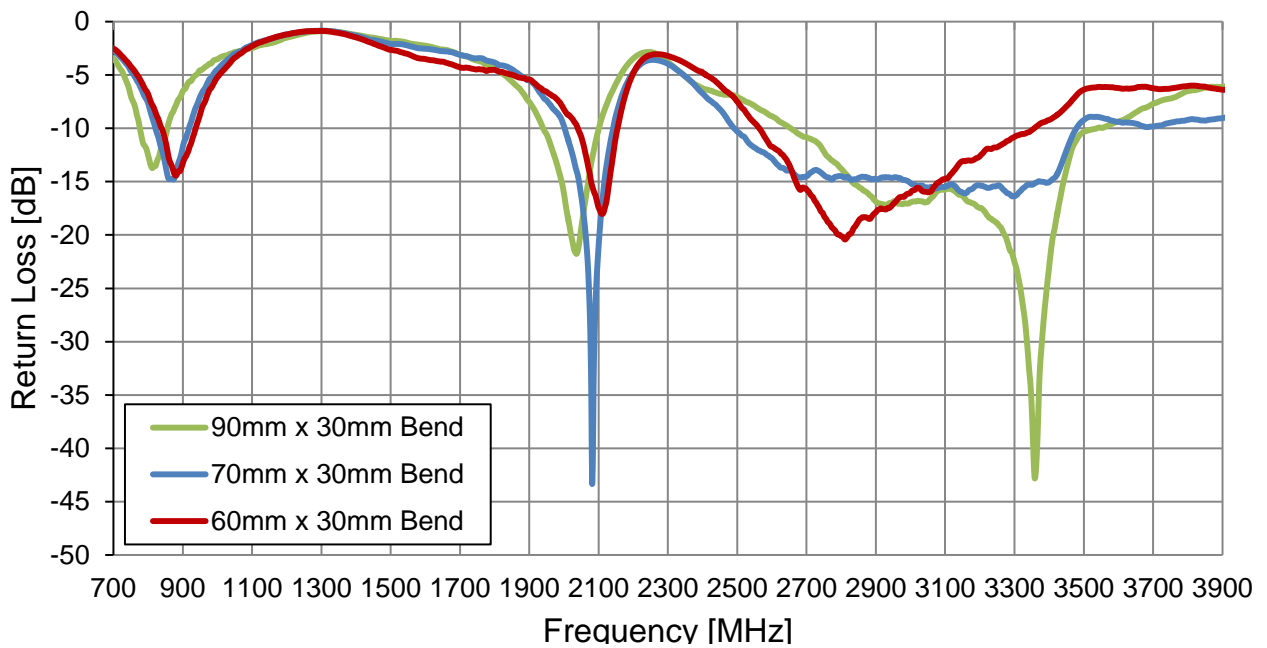
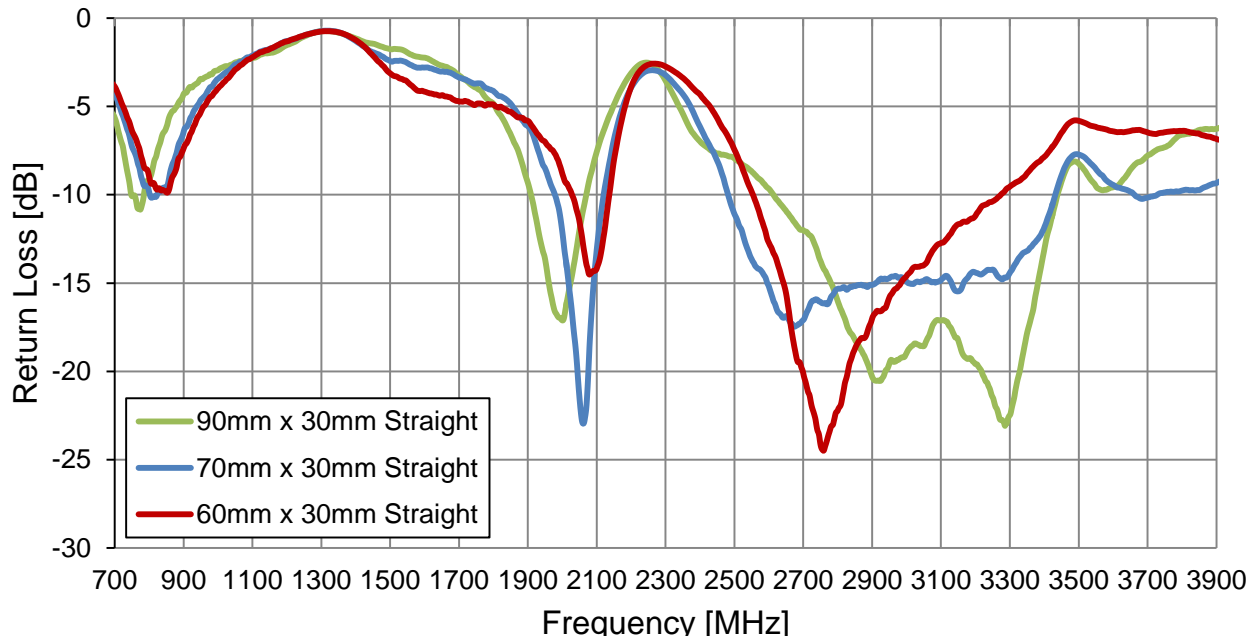

## 8.2 VSWR

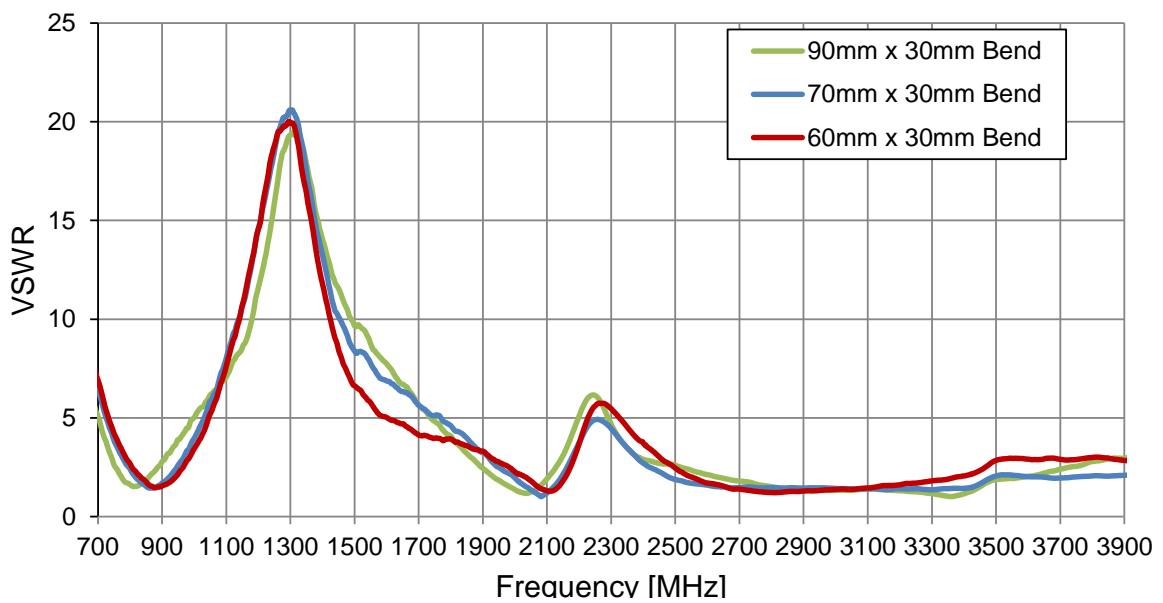
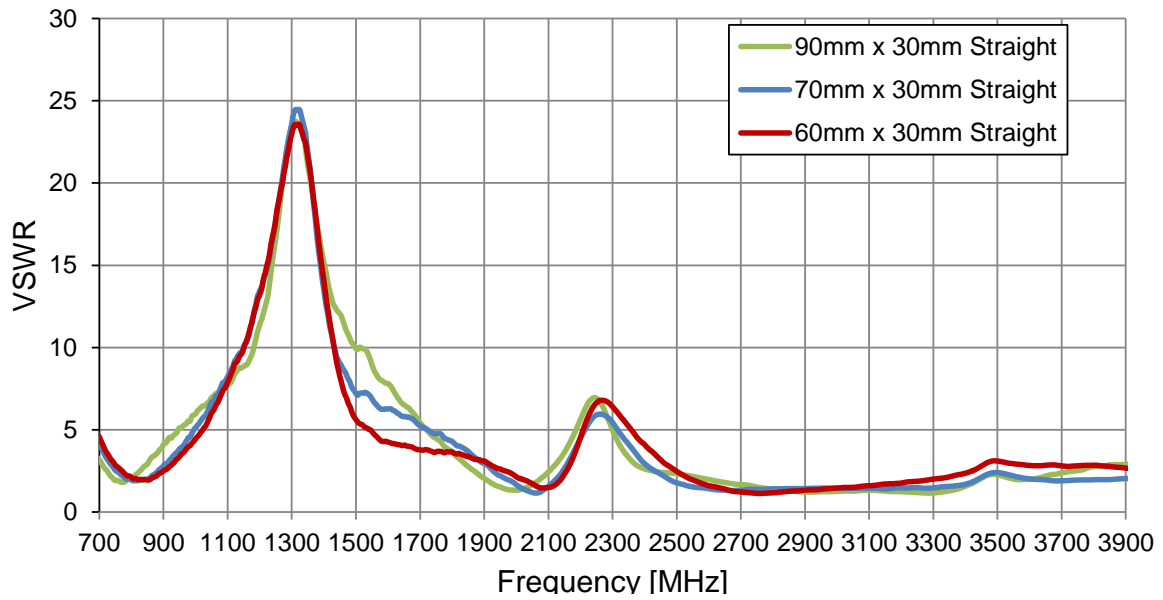

### 8.3 Efficiency

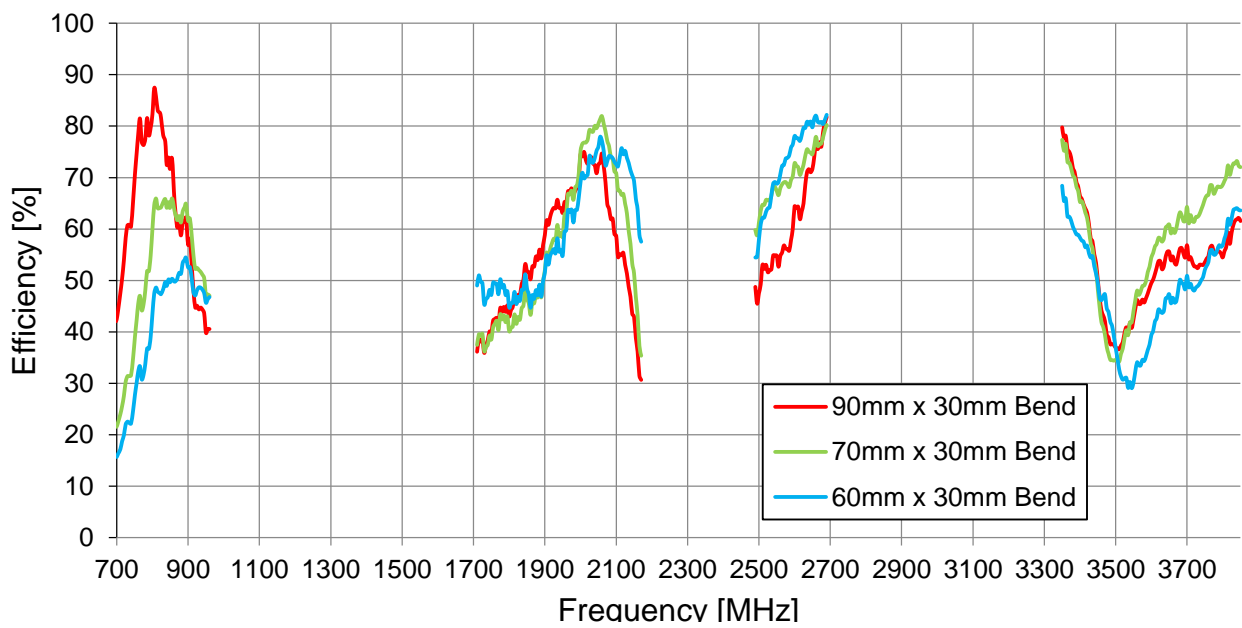
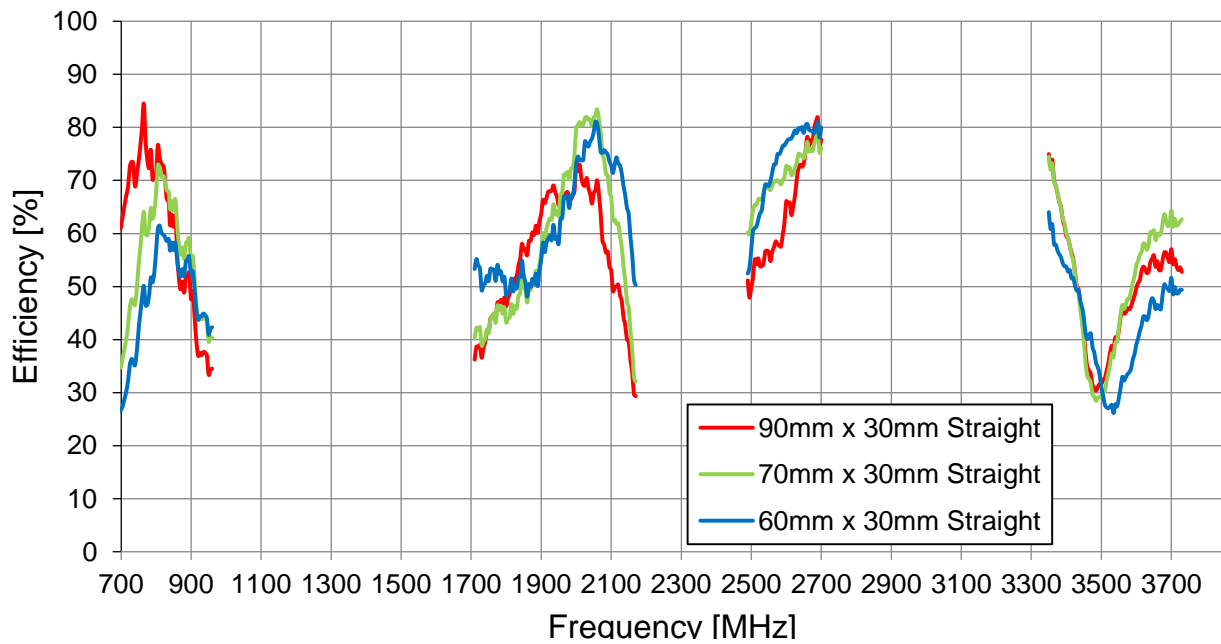

## 8.4 Peak Gain

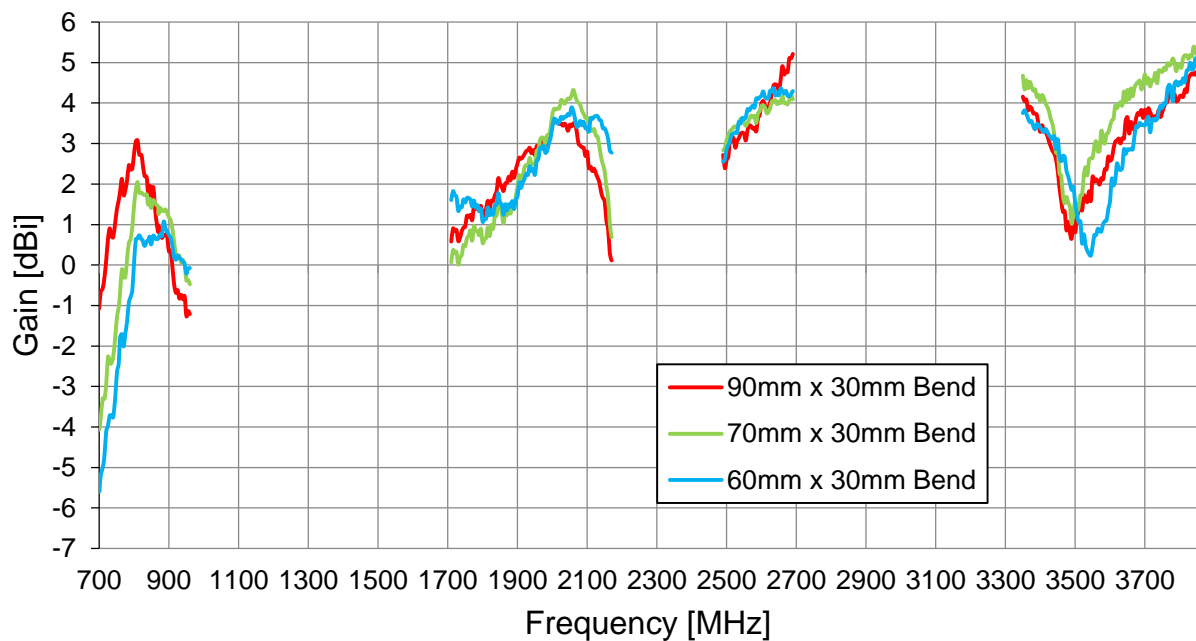
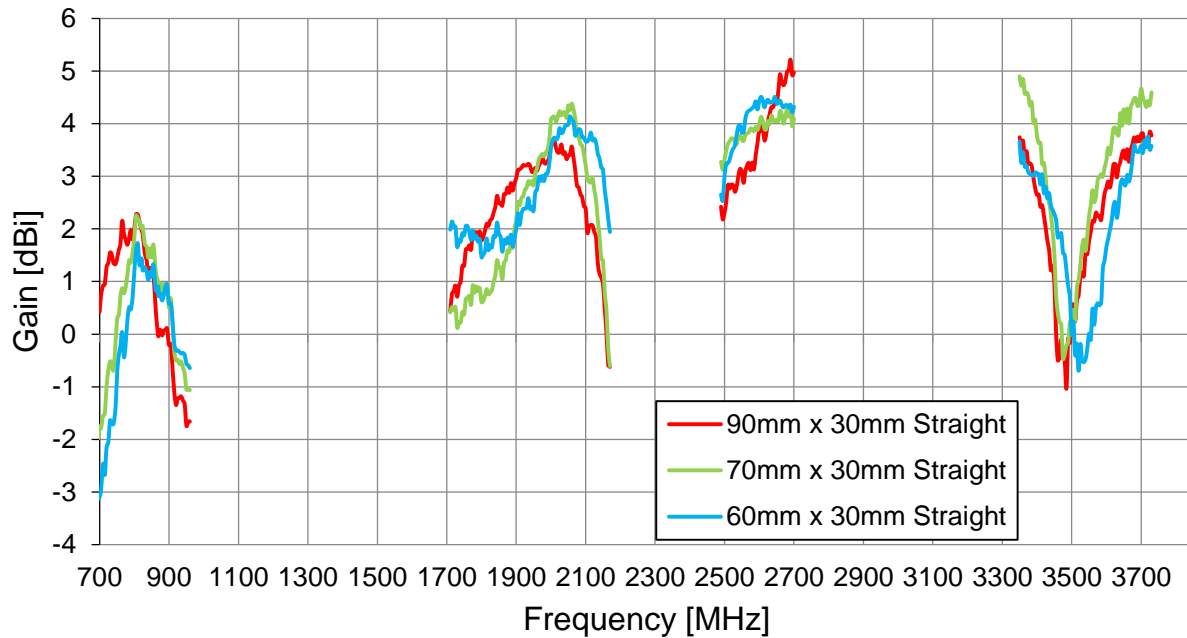

## 8.5 Average Gain

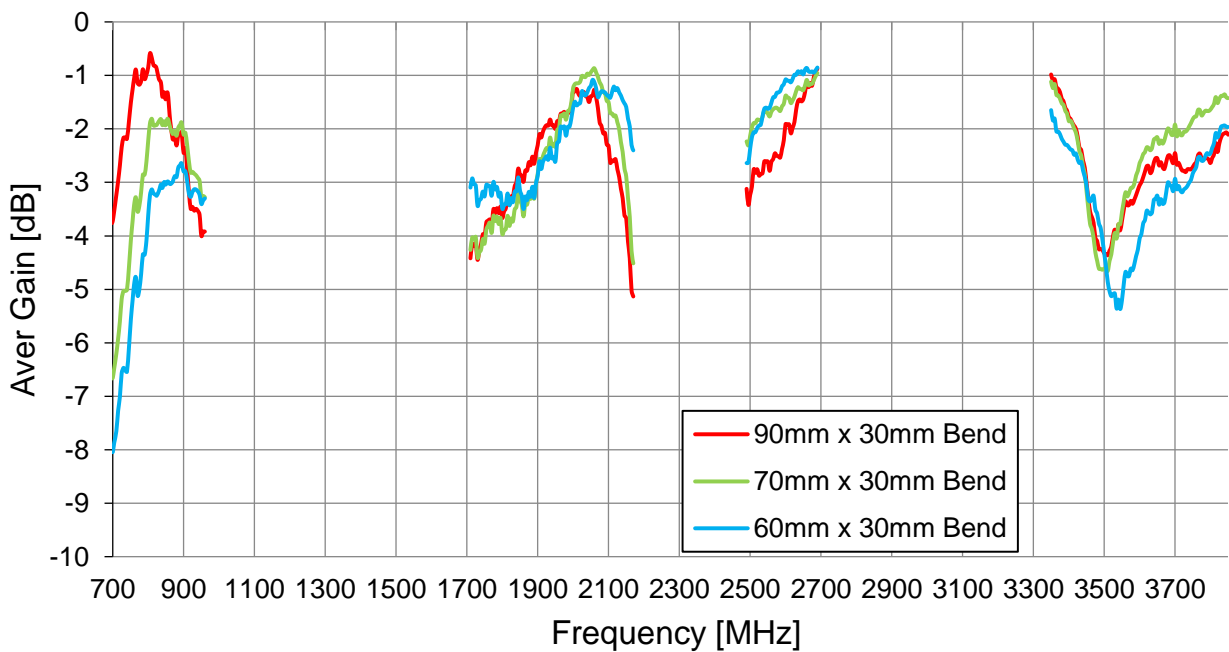
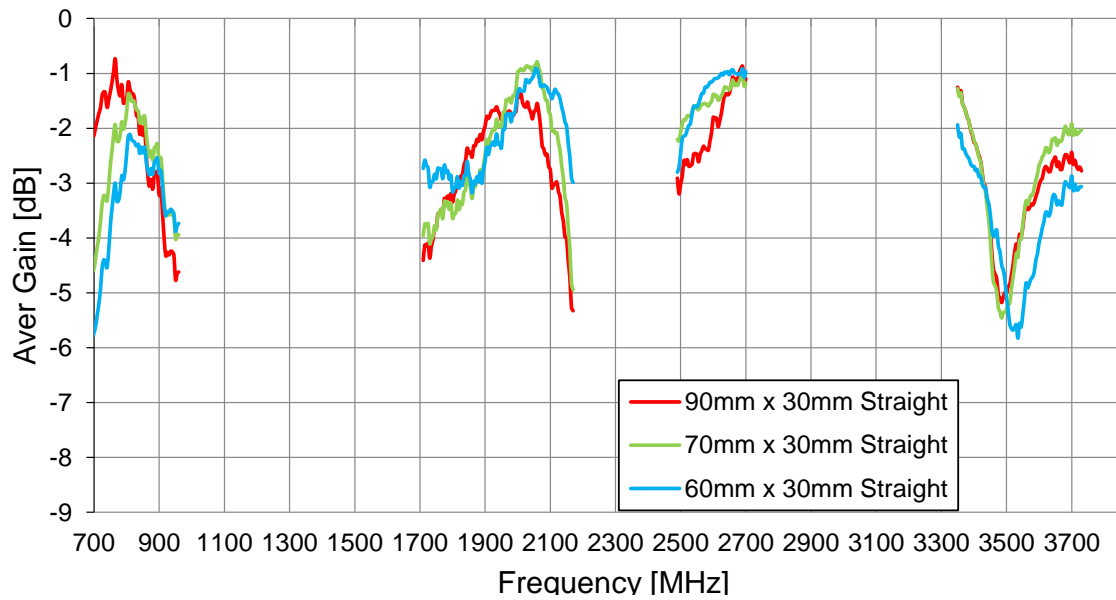

Changelog for the datasheet

**SPE-11-8-034 – TG.09.0113W**

**Revision: G (Current Version)**

Date:	2020-04-09
Changes:	Updated Data, Packaging and Template
Changes Made by:	Jack Conroy

**Previous Revisions**

**Revision: F**

Date:	2018-11-14
Changes:	Updated Data
Changes Made by:	Jack Conroy

**Revision: A (Original First Release)**

Date:	2010-03-29
Notes:	
Author:	Technical Writer

**Revision: E**

Date:	2016-10-17
Changes:	Update 4G data
Changes Made by:	Andy Mahoney

**Revision: D**

Date:	2012-06-19
Changes:	
Changes Made by:	Aine Doyle

**Revision: C**

Date:	2011-08-05
Changes:	
Changes Made by:	Technical Writer

**Revision: B**

Date:	2011-07-14
Changes:	
Changes Made by:	Technical Writer



**TAOGLAS®**

[www.taoglas.com](http://www.taoglas.com)



# Mouser Electronics

Authorized Distributor

Click to View Pricing, Inventory, Delivery & Lifecycle Information:

[Taoglas:](#)

[TG.09.0113w](#)