



TAOGLAS®



Datasheet

Pantheon White 2-in-1 Permanent Mount Antenna

Part No:
MA741.W.A.BI.001

Description:

White Pantheon Antenna 2-in-1 MA741
Permanent Mount 5G/4G *2 MIMO

Features:

2 x 5G/4G Cellular Antennas (MIMO)
IP67 Waterproof
High Efficiency / Peak Gain Outdoor Antenna
Dimensions: Ø143.2 x 82.4mm
Cables: 3m CFD-200 as standard, Fully customizable
Connectors: SMA(M) as standard, Fully customizable
White Enclosure
RoHs & Reach Compliant

1. Introduction	3
2. Specifications	4
3. Antenna Characteristics	7
4. Radiation Patterns	9
5. Mechanical Drawing	27
6. Installation	28
7. Packaging	29
<hr/>	
Changelog	30

Taoglas makes no warranties based on the accuracy or completeness of the contents of this document and reserves the right to make changes to specifications and product descriptions at any time without notice. Taoglas reserves all rights to this document and the information contained herein. Reproduction, use or disclosure to third parties without express permission is strictly prohibited.



1. Introduction



The Taoglas MA741.W Pantheon 2-in-1 antenna is an omnidirectional heavy-duty, fully IP67 waterproof external M2M antenna for use in telematics, transportation, and remote monitoring applications. This unique antenna delivers powerful MIMO antenna technology for 5G/4G Cellular.

The Pantheon MA741 covers all 5G bands from 600-6000MHz, exhibiting excellent performance at key 5G bands such as band 71(617MHz) and the repurposed CBRS and C-band frequencies from 3400-4200MHz. This ensures the Pantheon is prepared for mission critical applications.

Typical Applications Include:

- Public Safety
- Passenger Bus and Rail Services
- Digital Signage
- Commercial Transportation and Fleet Management

All five high-performance antennas are integrated into an extremely robust IP67 permanent mount compact antenna package measuring just 82.4mm in height and 143.2mm in diameter.

The antenna has its own ground-plane and can radiate on any mounting environment like metal or plastic without affecting performance. The cables are low loss allowing for lengths of up to 10 meters (32' and 9.70"), critical for buses, trains, and other commercial transport applications.

Customized cables and connector version available, contact your regional Taoglas customer support team for further information. The enclosure is also available in Black, MA741.A.BI.001.

2. Specifications

5G/4G MIMO									
Band	Frequency (MHz)	Test Setup		Efficiency (%)	Average Gain (dB)	Peak Gain (dBi)	VSWR	Impedance	Polarization
5G NR/4G Band 5,8,12,13,14,17,18,20, 26,27,28, 29,71	617~960	MIMO 1	Free Space	61	-2.2	3.3	3 Max	50Ω	Linear
			30X30cm GroundPlane	35	-1.7	3.5			
		MIMO 2	Free Space	69	-4.7	2.5			
			30X30cm GroundPlane	26	-6.1	1.4			
5G NR/4G Band 21,32,74,75,76	1427~1518	MIMO 1	Free Space	36	-4.4	2.8			
			30X30cm GroundPlane	21	-4.8	2.8			
		MIMO 2	Free Space	34	-7.0	-0.5			
			30X30cm GroundPlane	18	-7.8	0.5			
4G/3G Band 1,2,3,4,9,23,25,35,39,66	1710~2200	MIMO 1	Free Space	58	-2.4	3.1			
			30X30cm GroundPlane	48	-2.4	5.4			
		MIMO 2	Free Space	57	-3.2	3.2			
			30X30cm GroundPlane	47	-3.3	4.4			
Wi-Fi 2400	2400~2500	MIMO 1	Free Space	44	-3.6	2.1			
			30X30cm GroundPlane	64	-3.2	4.0			
		MIMO 2	Free Space	47	-1.9	5.2			
			30X30cm GroundPlane	67	-1.8	5.8			
4G/3G Band 7,38,41	2490~2690	MIMO 1	Free Space	51	-3.0	4.6			
			30X30cm GroundPlane	65	-2.6	4.7			
		MIMO 2	Free Space	55	-1.9	5.4			
			30X30cm GroundPlane	68	-1.7	6.2			
5G NR/4G Band 22,42,43,48,77,78,79	3300~5000	MIMO 1	Free Space	34	-5.2	5.8			
			30X30cm GroundPlane	41	-5.1	8.1			
		MIMO 2	Free Space	35	-4.0	4.7			
			30X30cm GroundPlane	42	-3.9	6.8			
LTE5200/ Wi-Fi 5800	5150~5925	MIMO 1	Free Space	16	-8.1	1.2			
			30X30cm GroundPlane	23	-8.2	2.4			
		MIMO 2	Free Space	16	-6.5	3.0			
			30X30cm GroundPlane	22	-6.7	3.3			

Mechanical	
Antenna Dimensions	Height 82.4mm x Diameter 143.19mm
Casing	Wonderloy PC-540 PC/ABS Alloy
Waterproof	IP67
5G/4G MIMO 1	3m CFD-200 SMA(M)
5G/4G MIMO 2	3m CFD-200 SMA(M)
Base and thread	CAN10 Zinc Alloy
Thread diameter	M30 x 2 (30mm)
Nut	Nickel Plated Steel
Foam	3M 9448HK
Weight(kg)	1.16Kg
Recommended Torque for Mounting	5-7Nm
Enviromental	
Operation Temperature	-40°C to 85°C
Storage Temperature	-40°C to 90°C
Humidity	Non-condensing 65°C 95% RH

5G/4G Bands			
Band Number	5GNR / FR1 / LTE / LTE-Advanced / WCDMA / HSPA / HSPA+ / TD-SCDMA		
	Uplink	Downlink	Covered
1	UL: 1920 to 1980	DL: 2110 to 2170	✓
2	UL: 1850 to 1910	DL: 1930 to 1990	✓
3	UL: 1710 to 1785	DL: 1805 to 1880	✓
4	UL: 1710 to 1755	DL: 2110 to 2155	✓
5	UL: 824 to 849	DL: 869 to 894	✓
7	UL: 2500 to 2570	DL: 2620 to 2690	✓
8	UL: 880 to 915	DL: 925 to 960	✓
9	UL: 1749.9 to 1784.9	DL: 1844.9 to 1879.9	✓
11	UL: 1427.9 to 1447.9	DL: 1475.9 to 1495.9	✓
12	UL: 699 to 716	DL: 729 to 746	✓
13	UL: 777 to 787	DL: 746 to 756	✓
14	UL: 788 to 798	DL: 758 to 768	✓
17	UL: 704 to 716	DL: 734 to 746	✓
18	UL: 815 to 830	DL: 860 to 875	✓
19	UL: 830 to 845	DL: 875 to 890	✓
20	UL: 832 to 862	DL: 791 to 821	✓
21	UL: 1447.9 to 1462.9	DL: 1495.9 to 1510.9	✓
22	UL: 3410 to 3490	DL: 3510 to 3590	✓
23	UL: 2000 to 2020	DL: 2180 to 2200	✓
24	UL: 1625.5 to 1660.5	DL: 1525 to 1559	✓
25	UL: 1850 to 1915	DL: 1930 to 1995	✓
26	UL: 814 to 849	DL: 859 to 894	✓
27	UL: 807 to 824	DL: 852 to 869	✓
28	UL: 703 to 748	DL: 758 to 803	✓
29	UL: -	DL: 717 to 728	✓
30	UL: 2305 to 2315	DL: 2350 to 2360	✓
31	UL: 452.5 to 457.5	DL: 462.5 to 467.5	✗
32	UL: -	DL: 1452 - 1496	✓
35		1850 to 1910	✓
38		2570 to 2620	✓
39		1880 to 1920	✓
40		2300 to 2400	✓
41		2496 to 2690	✓
42		3400 to 3600	✓
43		3600 to 3800	✓
48		3550 to 3700	✓
66	UL: 1710-1780	DL: 2110-2200	✓
71		617 to 698	✓
74/75/76		1427 to 1518	✓
78		3300 to 3800	✓
79		4400 to 5000	✓
85	698-716	728-746	✓

3. Antenna Characteristics

3.1 Return Loss

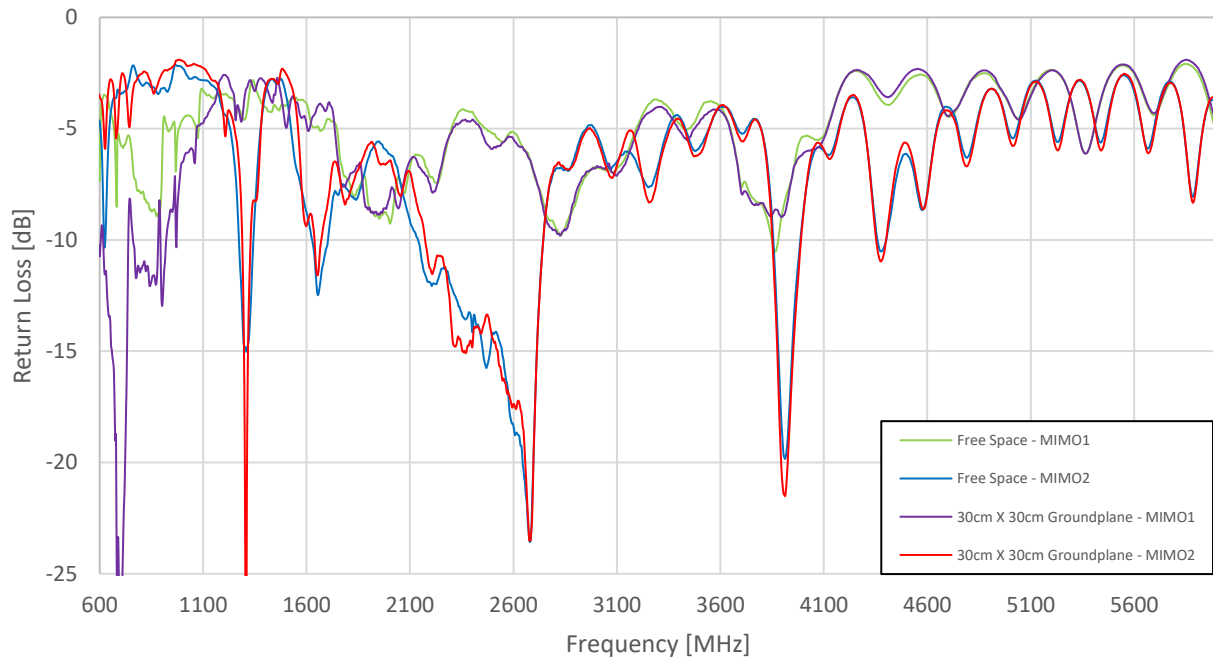

3.2 Efficiency

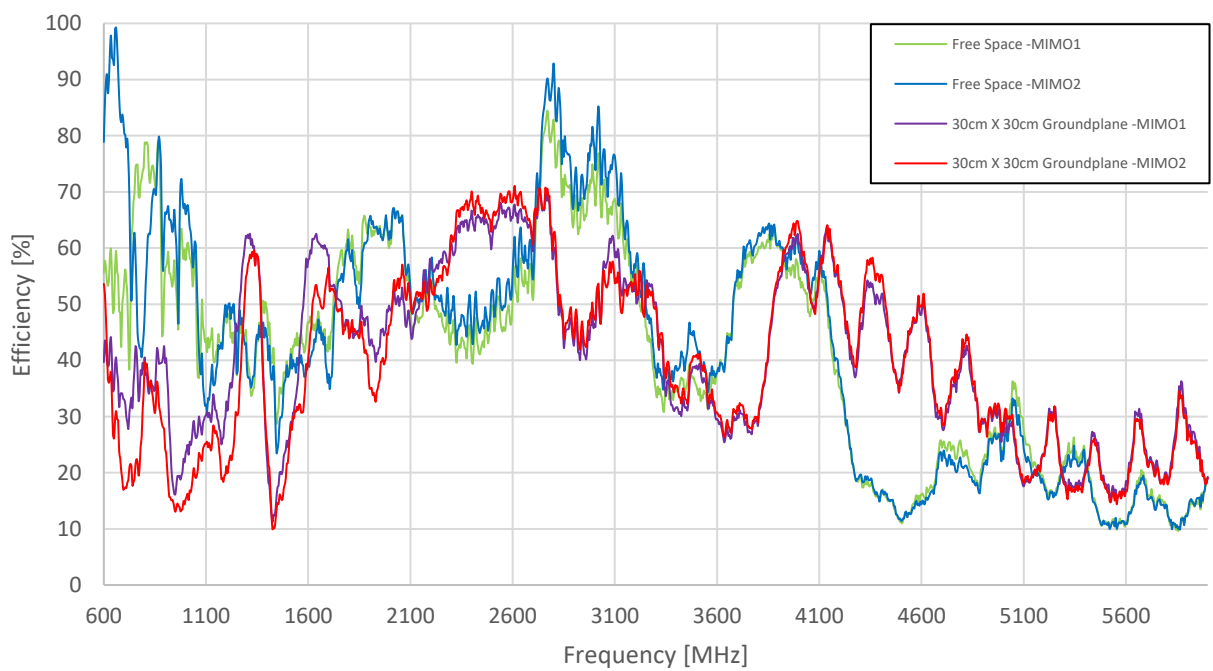

3.3 Peak Gain

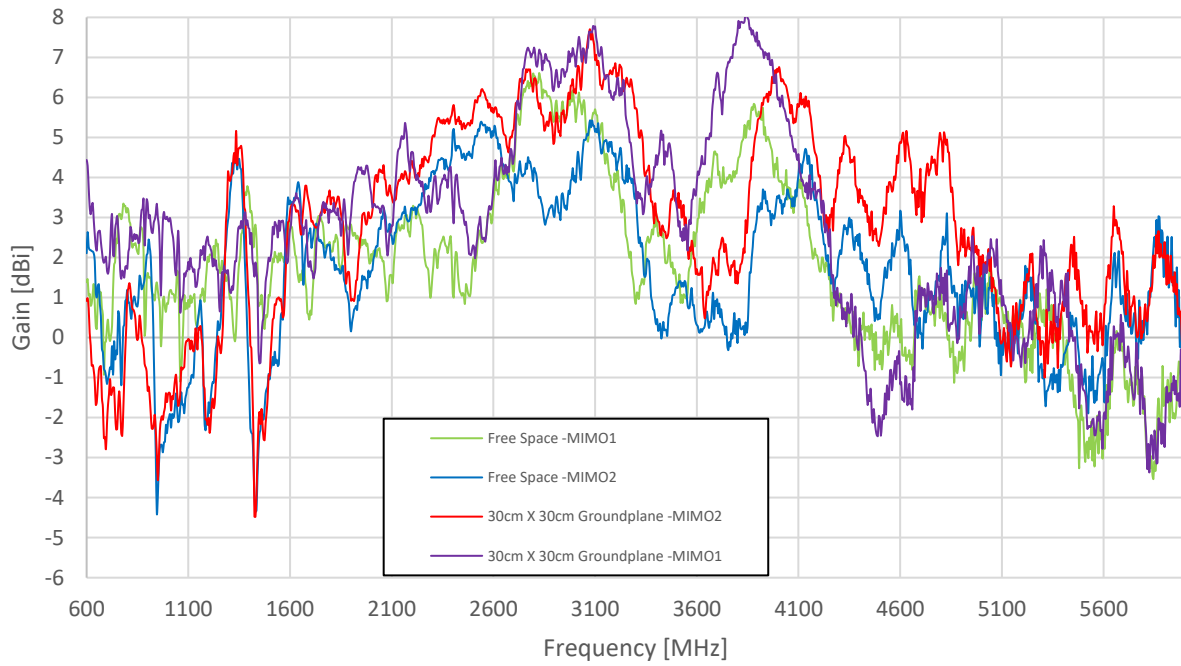

3.4 Average Gain

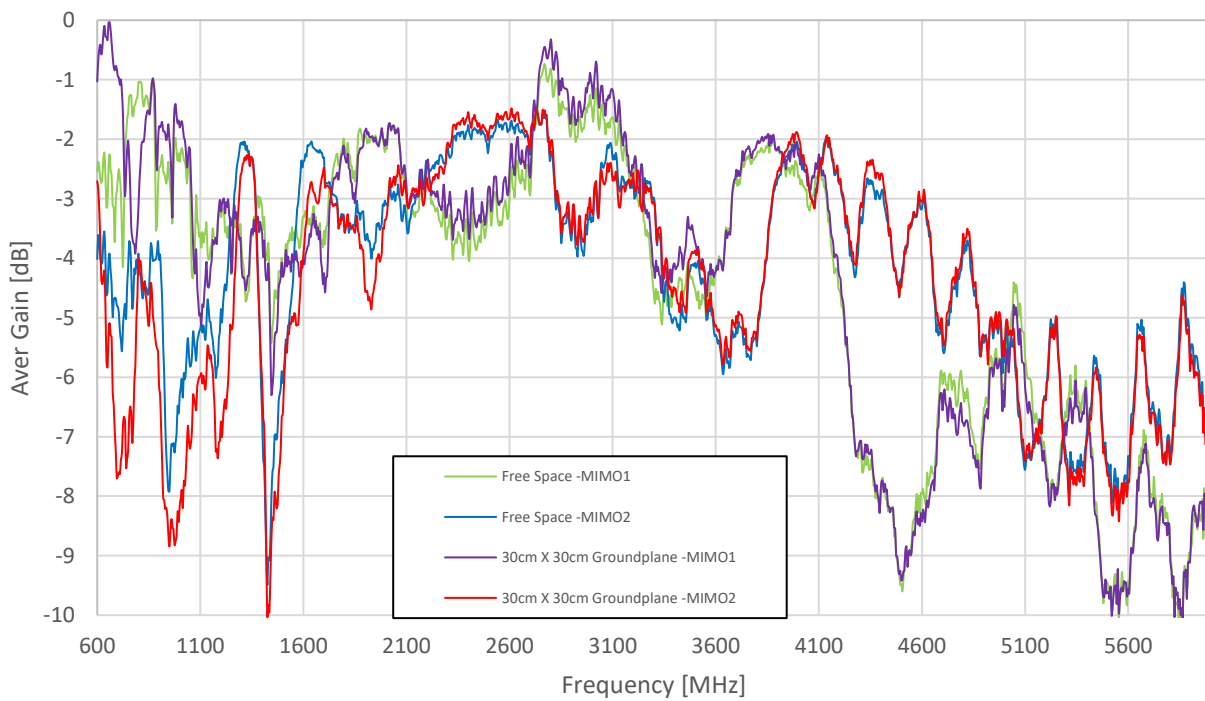

4. Radiation Patterns

4.1 Test Setup

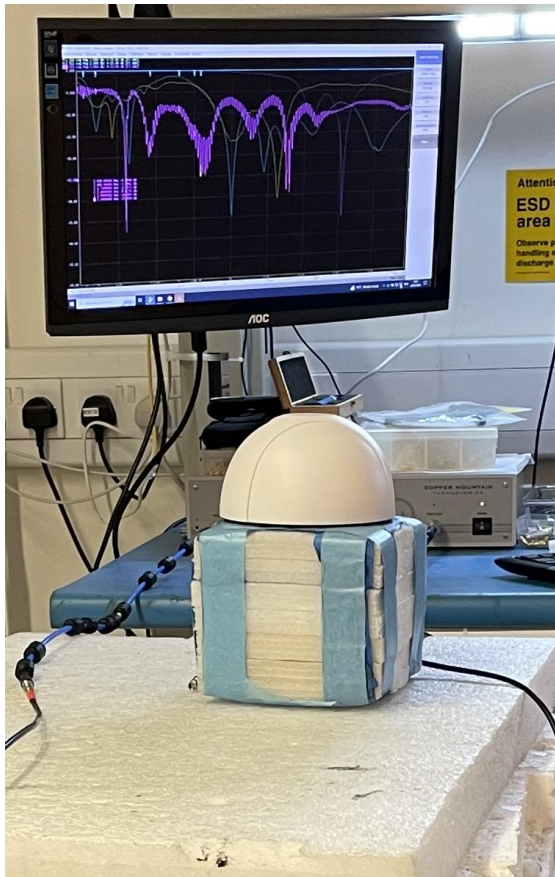

VNA Test Set-up in Free Space

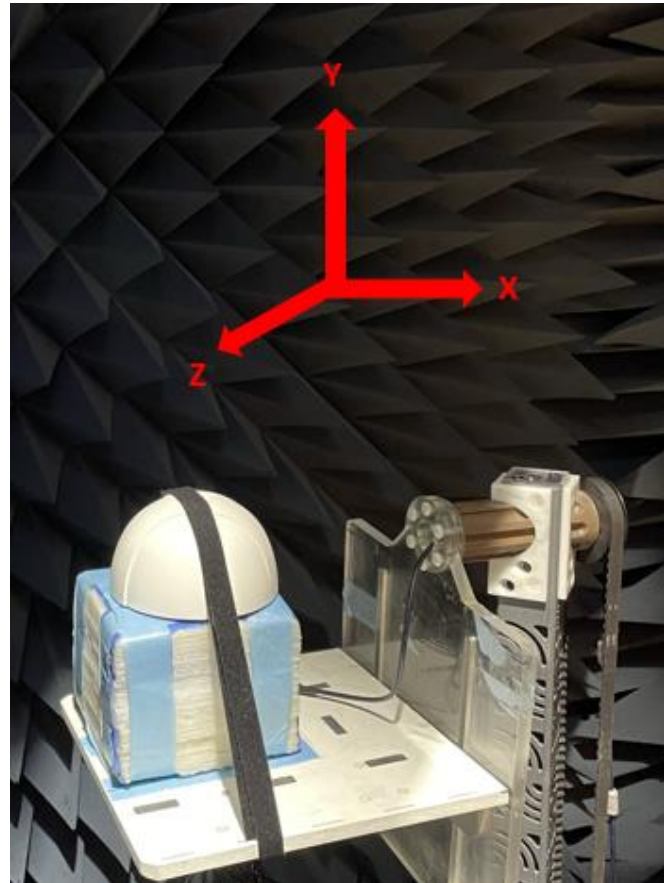

Chamber Test Set-up in Free Space

4.2 705MHz 3D and 2D Cellular Radiation Patterns

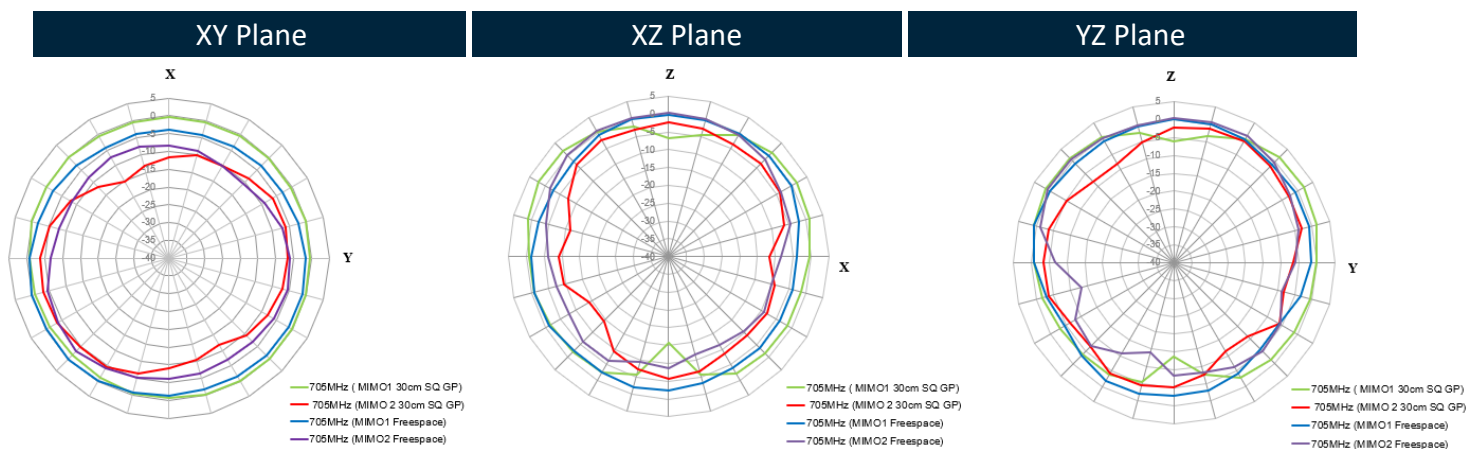
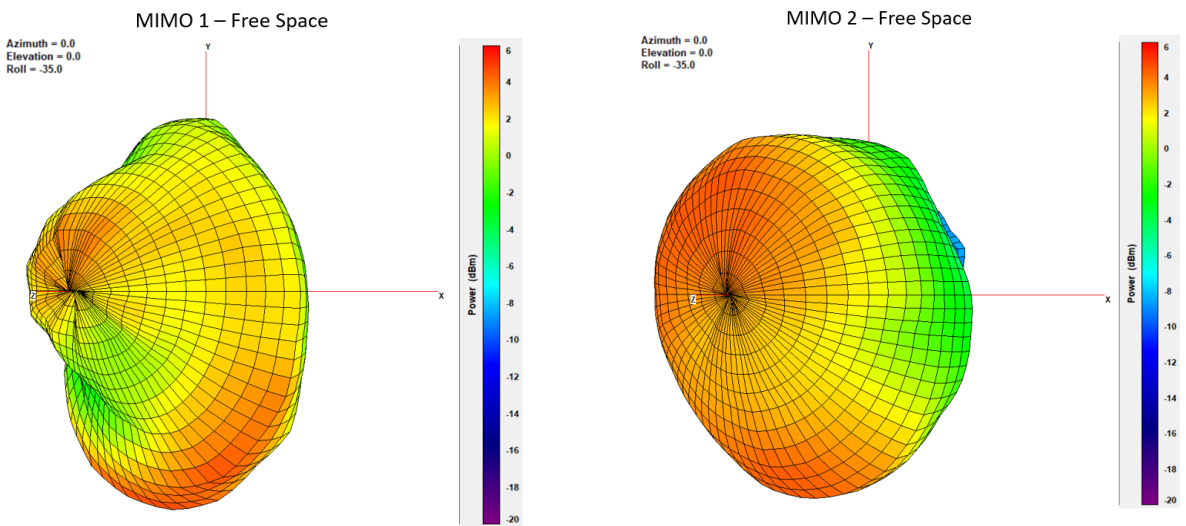
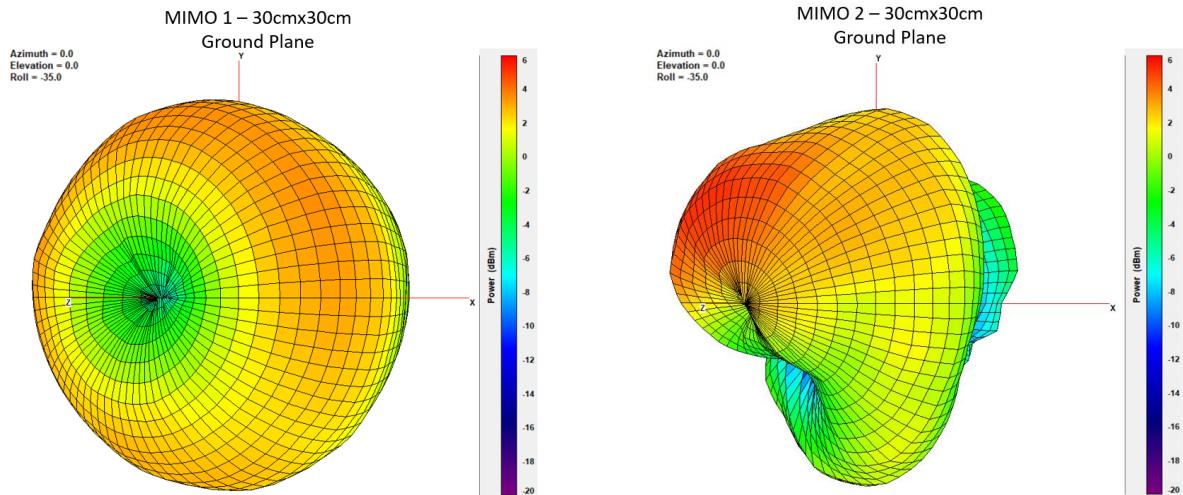

750MHz

MIMO 1 – 30cmx30cm
Ground Plane

Azimuth = 0.0
Elevation = 0.0
Roll = -35.0

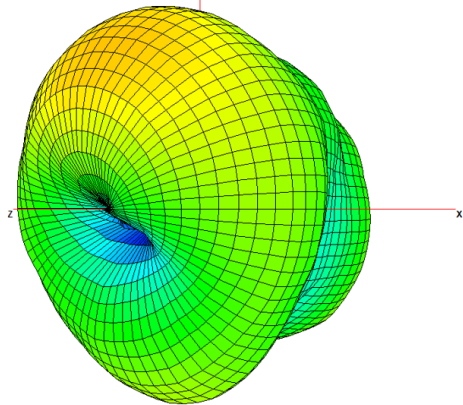

MIMO 2 – 30cmx30cm
Ground Plane

Azimuth = 0.0
Elevation = 0.0
Roll = -35.0

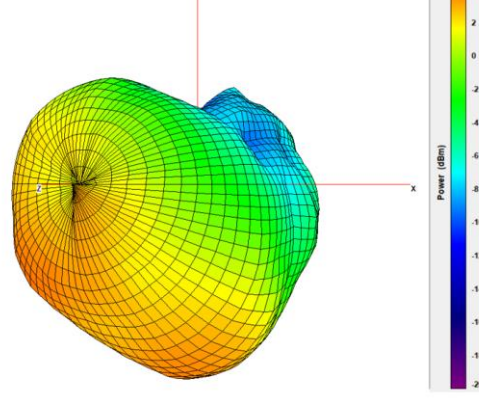

MIMO 1 – Free Space

Azimuth = 0.0
Elevation = 0.0
Roll = -35.0

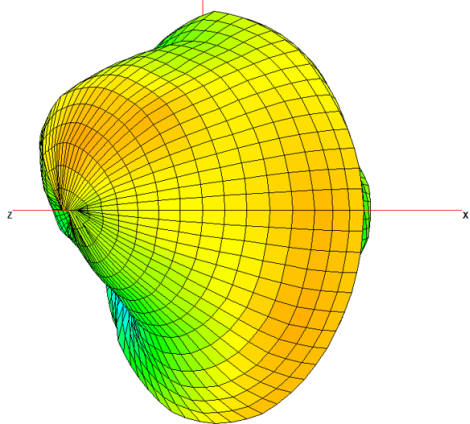

MIMO 2 – Free Space

Azimuth = 0.0
Elevation = 0.0
Roll = -35.0

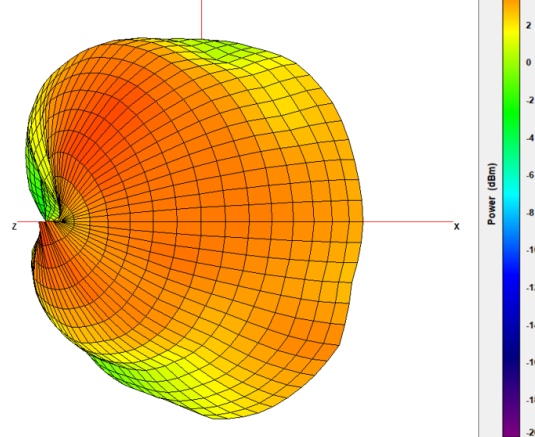

XY Plane
XZ Plane
YZ Plane

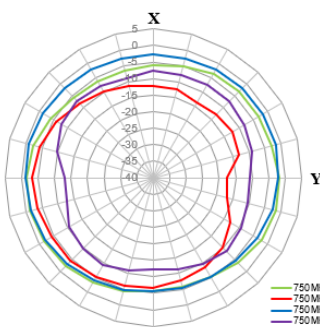

— 750MHz (MIMO1 30cm SQ GP)
— 750MHz (MIMO2 30cm SQ GP)
— 750MHz (MIMO1 Free Space)
— 750MHz (MIMO2 Free Space)

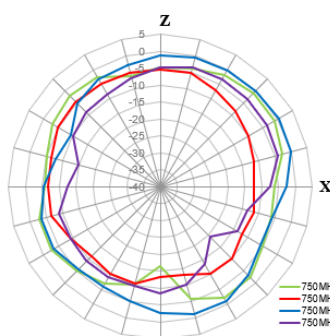

— 750MHz (MIMO1 30cm SQ GP)
— 750MHz (MIMO2 30cm SQ GP)
— 750MHz (MIMO1 Free Space)
— 750MHz (MIMO2 Free Space)

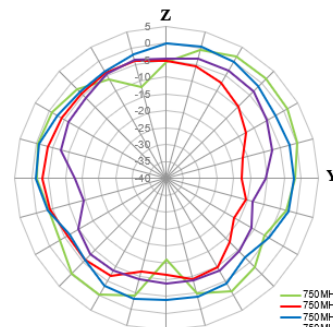

— 750MHz (MIMO1 30cm SQ GP)
— 750MHz (MIMO2 30cm SQ GP)
— 750MHz (MIMO1 Free Space)
— 750MHz (MIMO2 Free Space)

825MHz

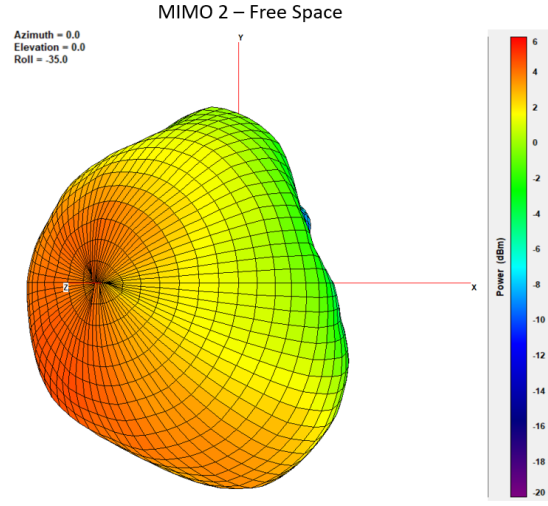
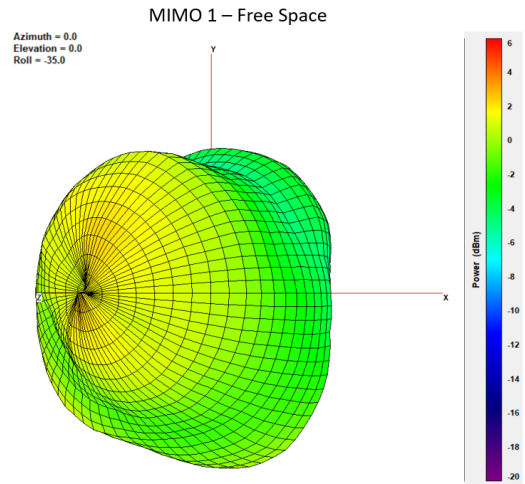
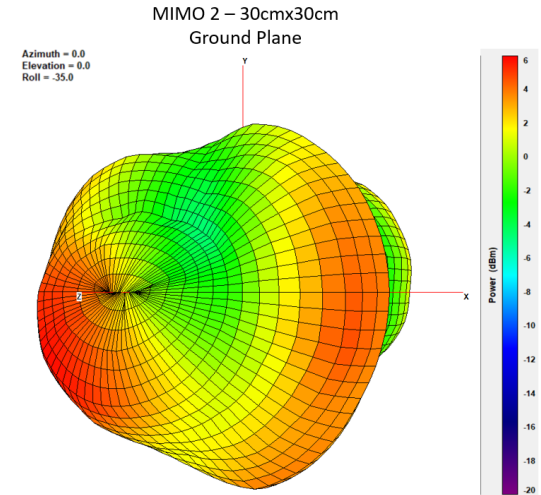
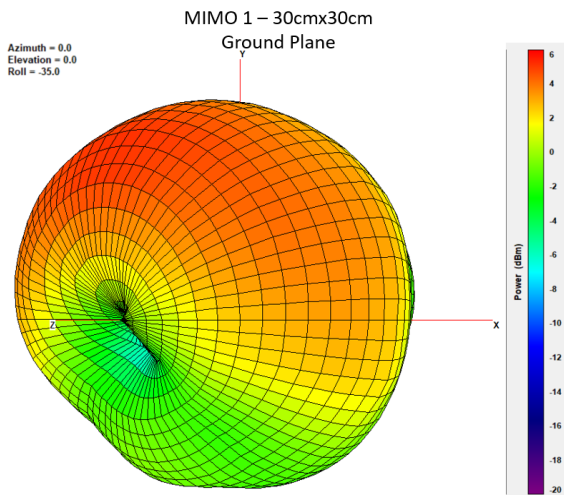

XY Plane

XZ Plane

YZ Plane

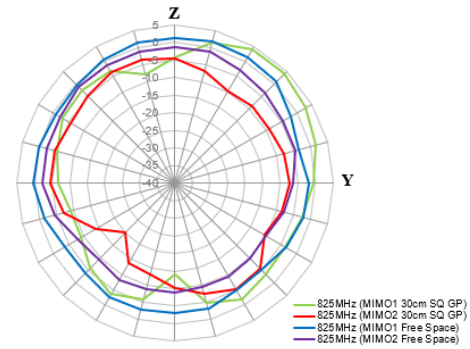
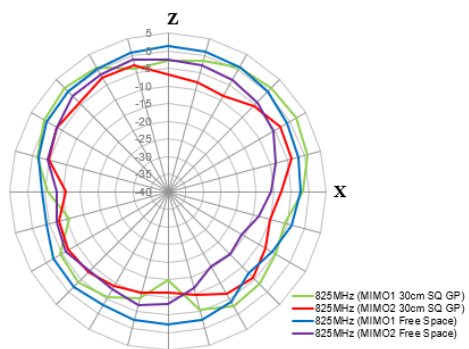
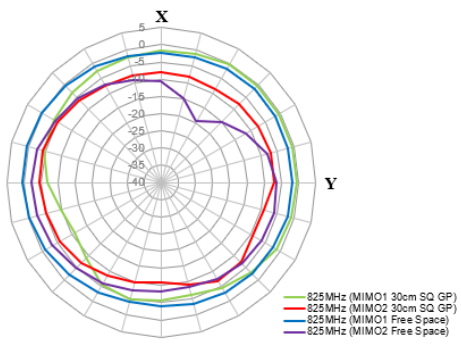

880MHz

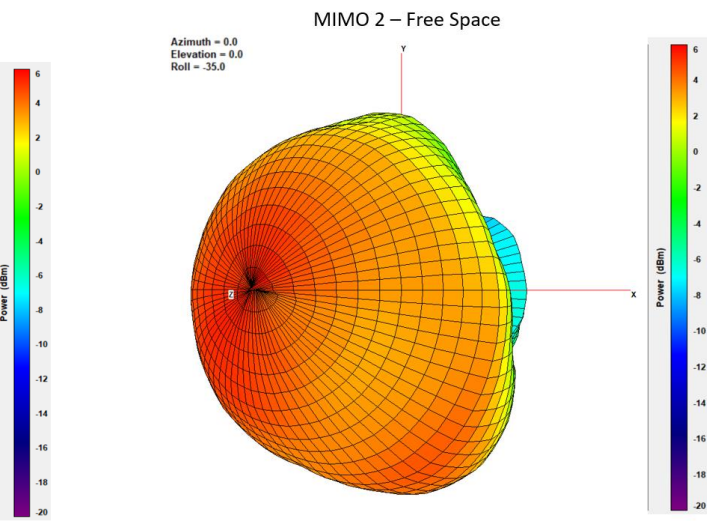
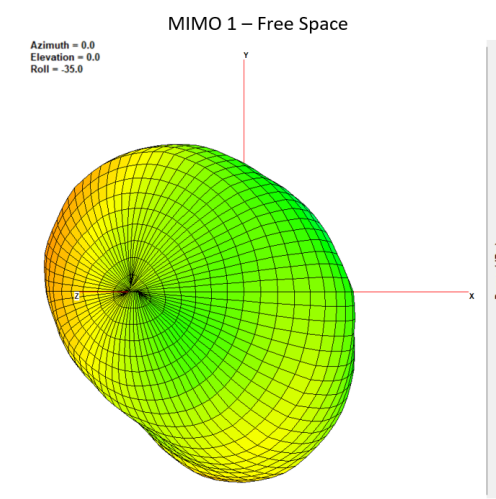
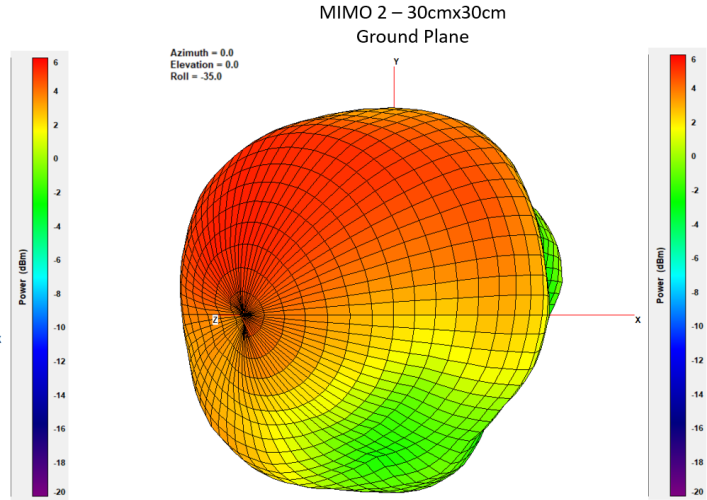
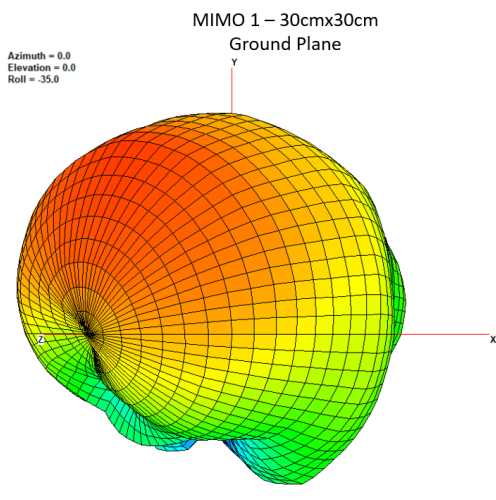

XY Plane

XZ Plane

YZ Plane

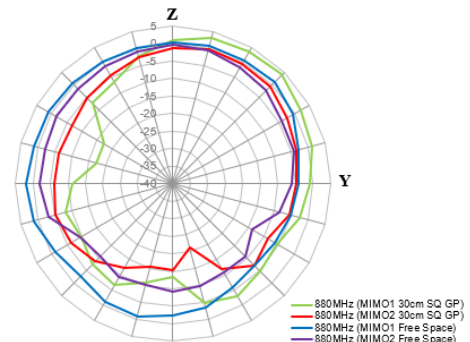
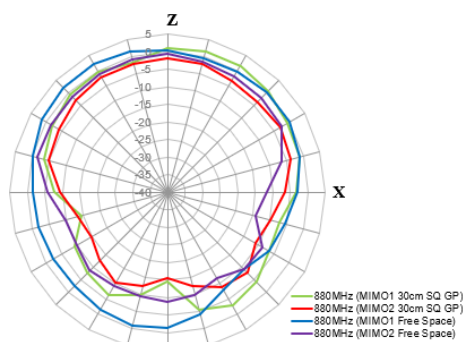
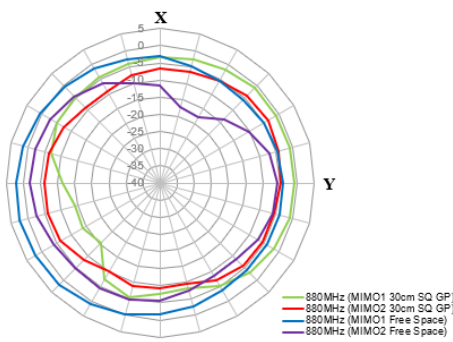

960MHz

MIMO 1 – 30cmx30cm
Ground Plane

Azimuth = 0.0
Elevation = 0.0
Roll = -35.0

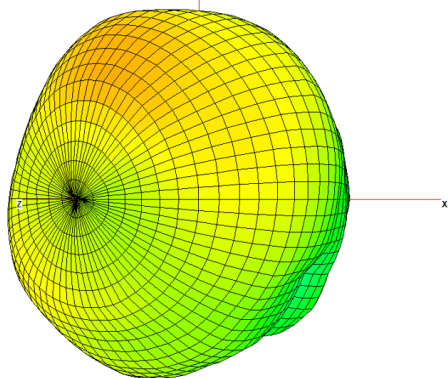

MIMO 2 – 30cmx30cm
Ground Plane

Azimuth = 0.0
Elevation = 0.0
Roll = -35.0

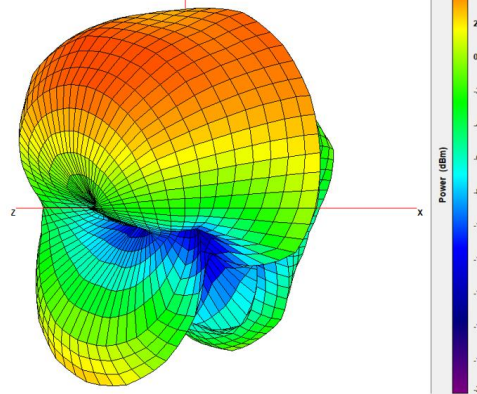

MIMO 1 – Free Space

Azimuth = 0.0
Elevation = 0.0
Roll = -35.0

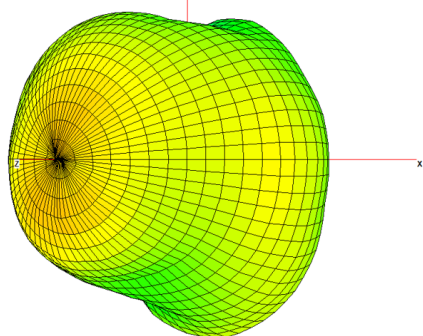

MIMO 2 – Free Space

Azimuth = 0.0
Elevation = 0.0
Roll = -35.0

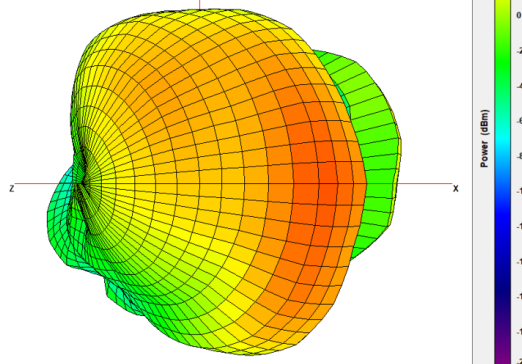

XY Plane

XZ Plane

YZ Plane

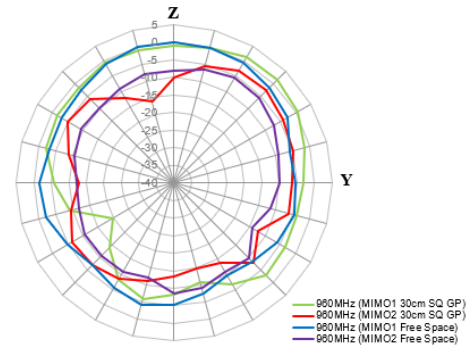
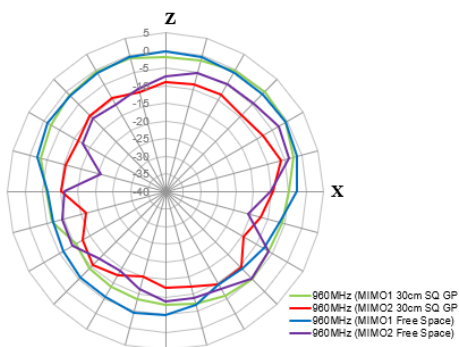
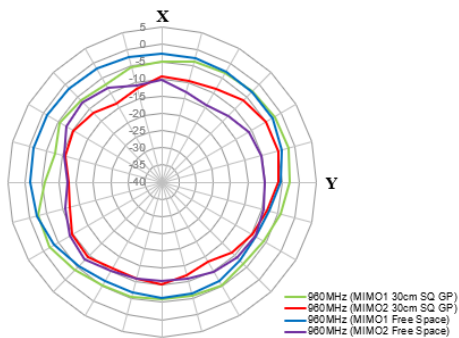

1710MHz

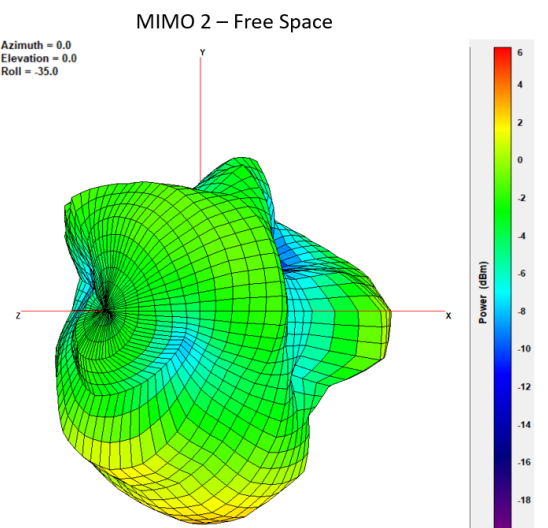
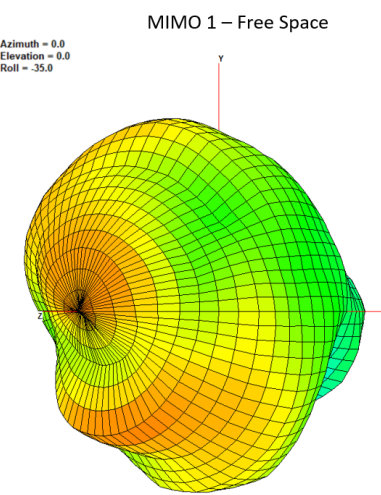
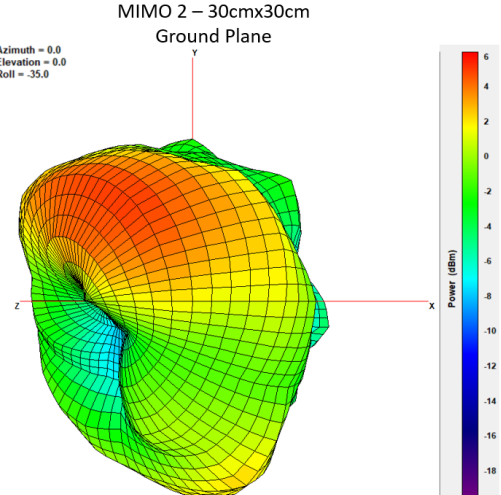
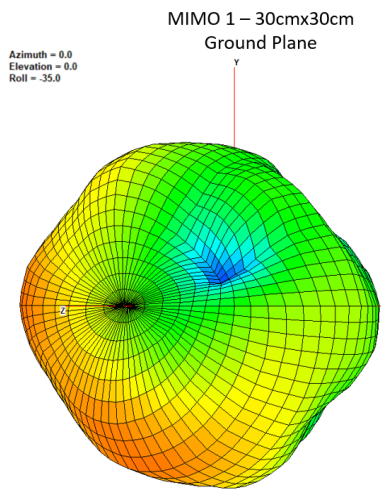

XY Plane

XZ Plane

YZ Plane

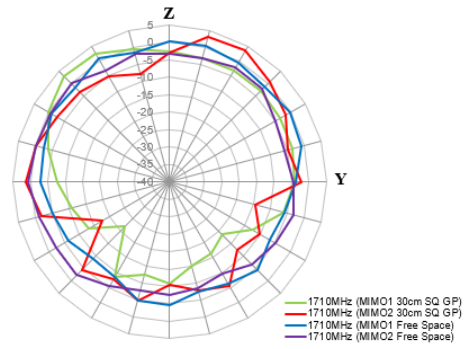
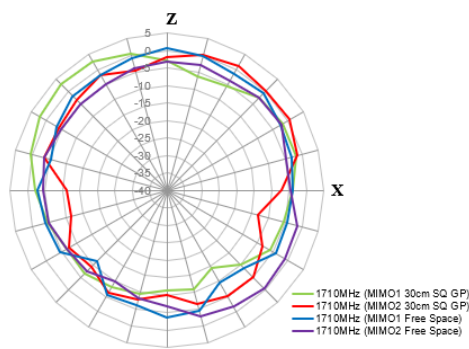
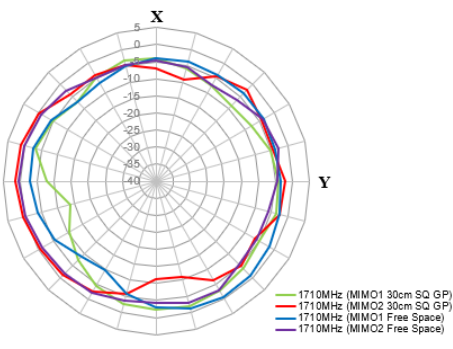

1880MHz

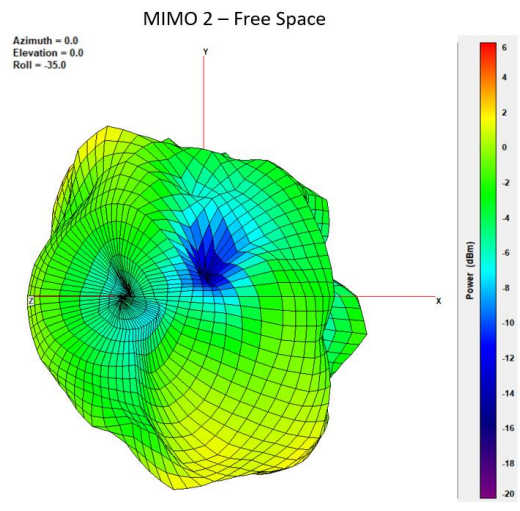
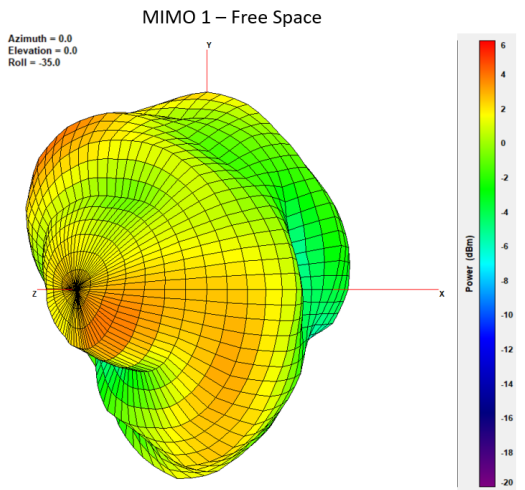
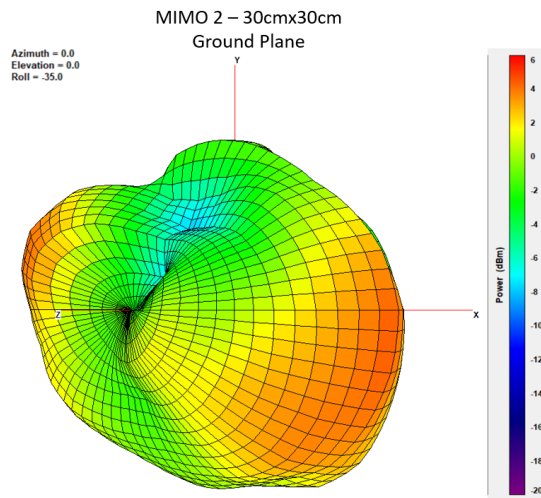
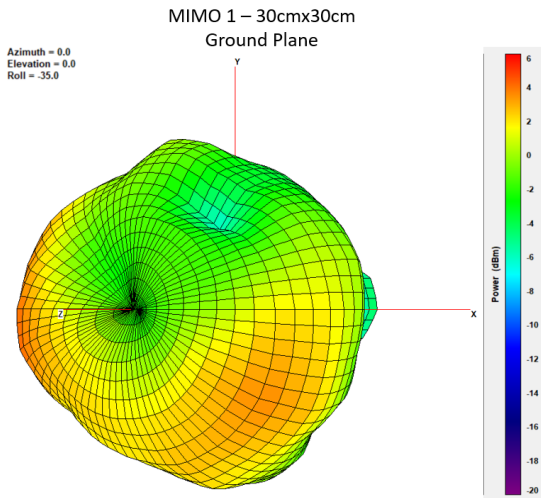

XY Plane

XZ Plane

YZ Plane

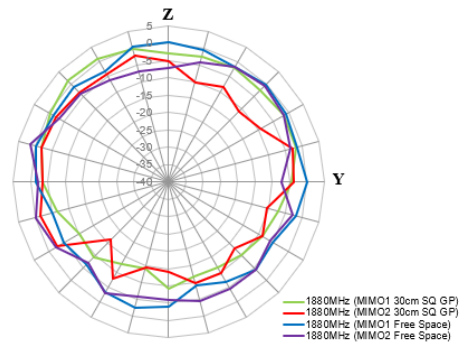
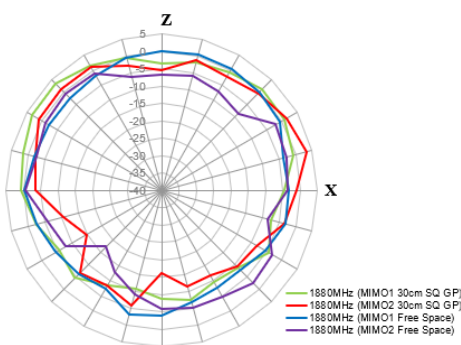
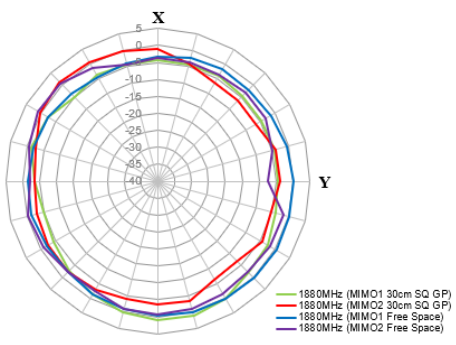

1990MHz

MIMO 1 – 30cmx30cm
Ground Plane

Azimuth = 0.0
Elevation = 0.0
Roll = -35.0

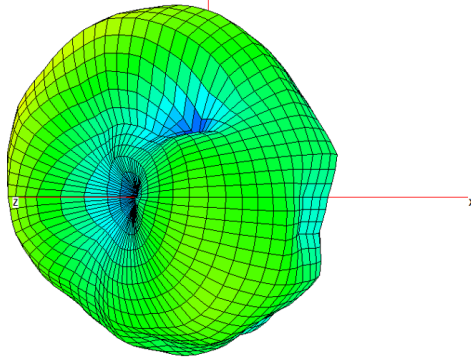

MIMO 2 – 30cmx30cm
Ground Plane

Azimuth = 0.0
Elevation = 0.0
Roll = -35.0

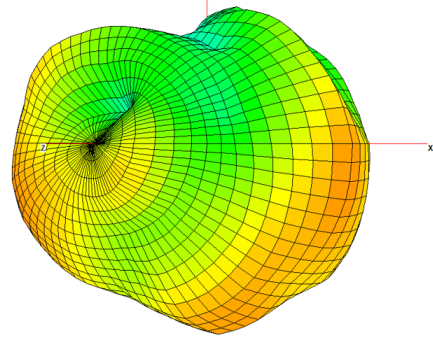

MIMO 1 – Free Space

Azimuth = 0.0
Elevation = 0.0
Roll = -35.0

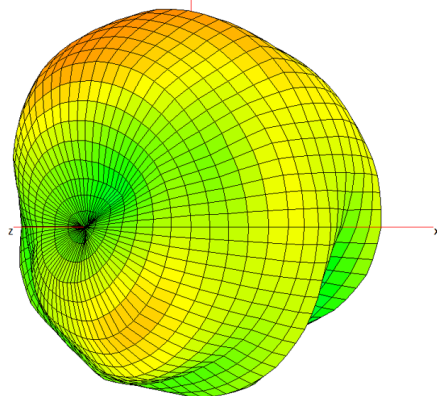

MIMO 2 – Free Space

Azimuth = 0.0
Elevation = 0.0
Roll = -35.0

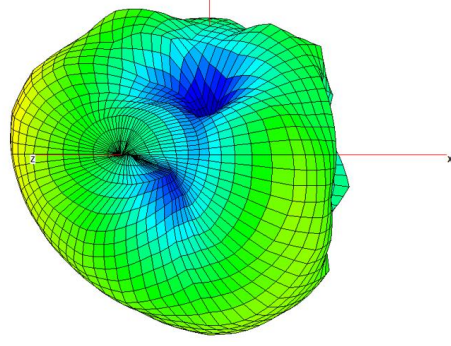

XY Plane

XZ Plane

YZ Plane

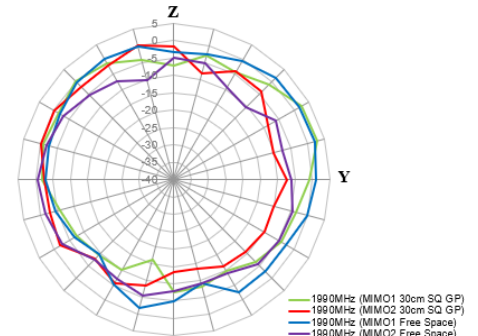
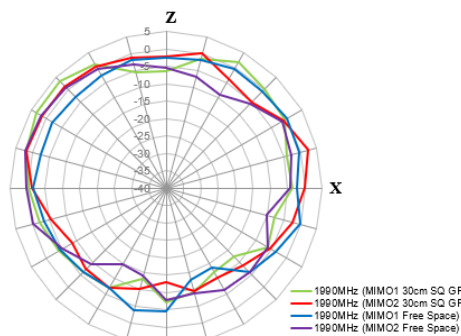
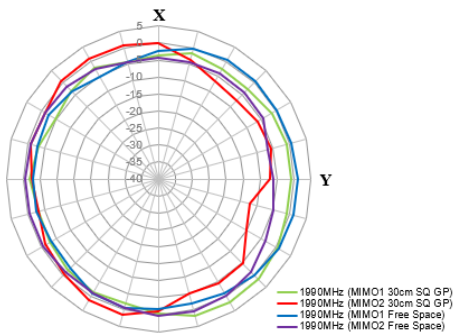

2170MHz

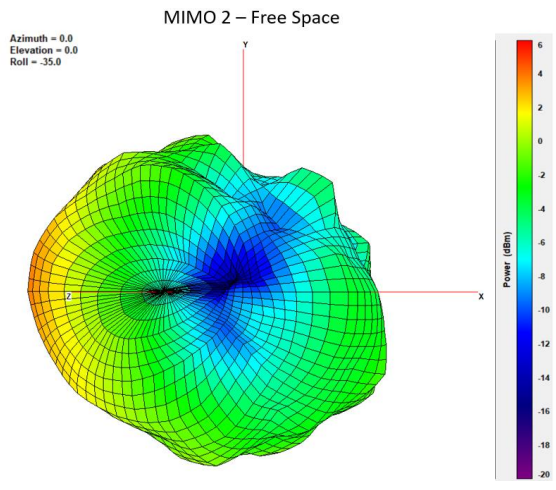
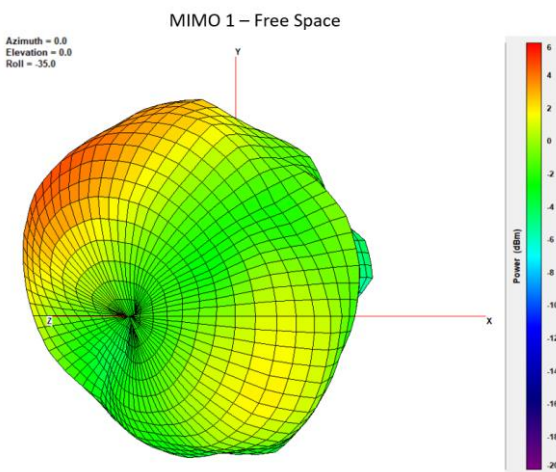
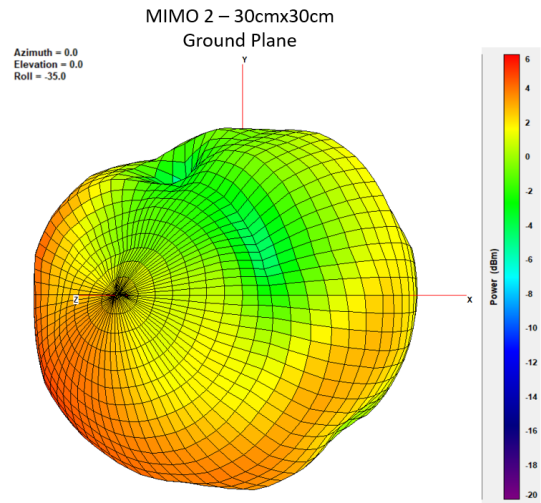
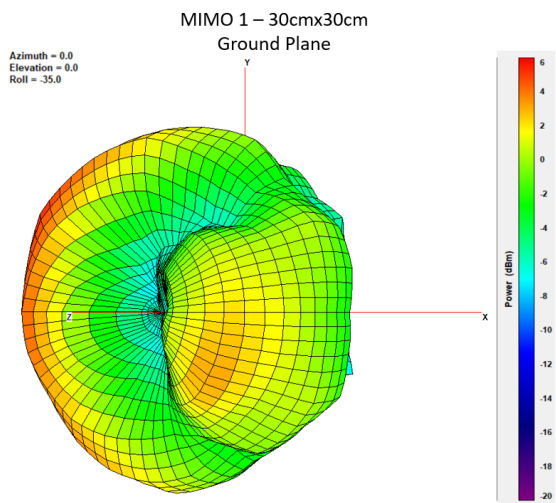

XY Plane

XZ Plane

YZ Plane

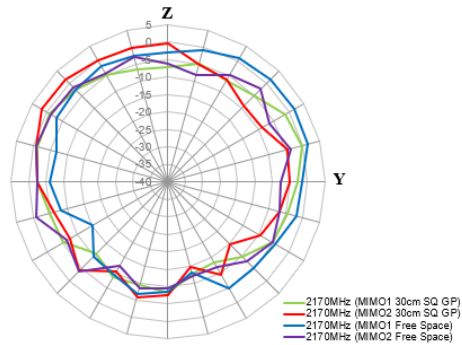
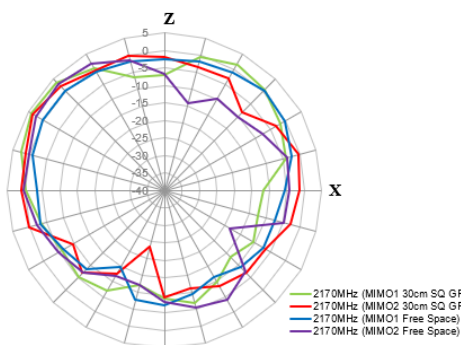
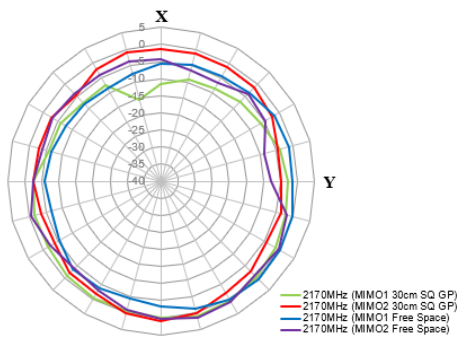

2300MHz

**MIMO 1 – 30cmx30cm
Ground Plane**

Azimuth = 0.0
Elevation = 0.0
Roll = -35.0

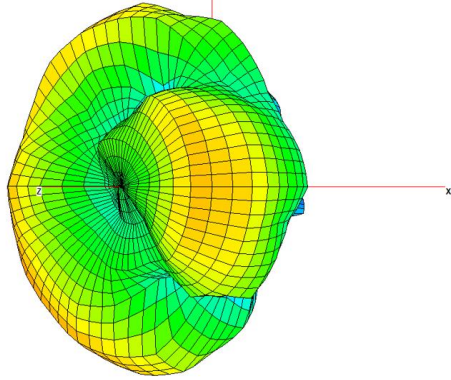

**MIMO 2 – 30cmx30cm
Ground Plane**

Azimuth = 0.0
Elevation = 0.0
Roll = -35.0

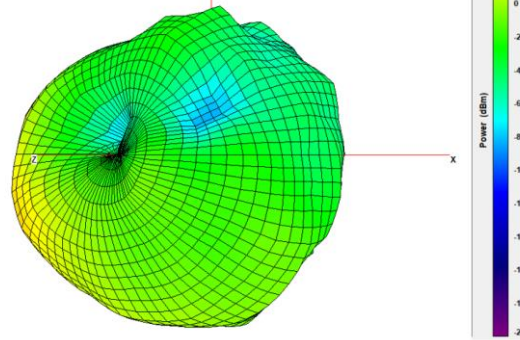

MIMO 1 – Free Space

Azimuth = 0.0
Elevation = 0.0
Roll = -35.0

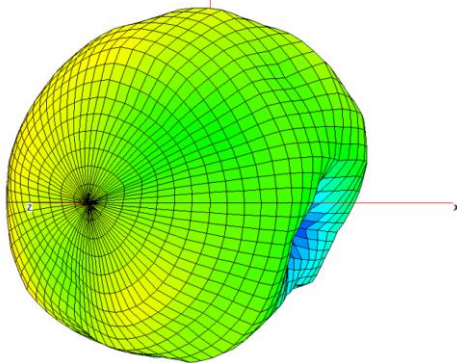

MIMO 2 – Free Space

Azimuth = 0.0
Elevation = 0.0
Roll = -35.0

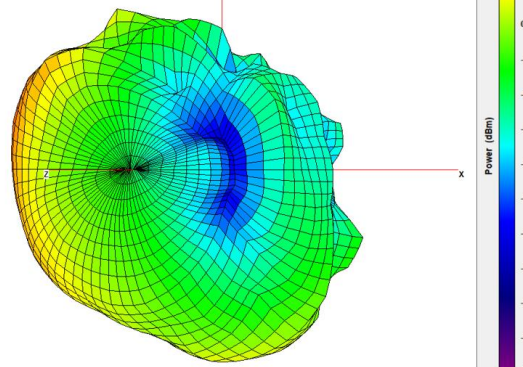

XY Plane

XZ Plane

YZ Plane

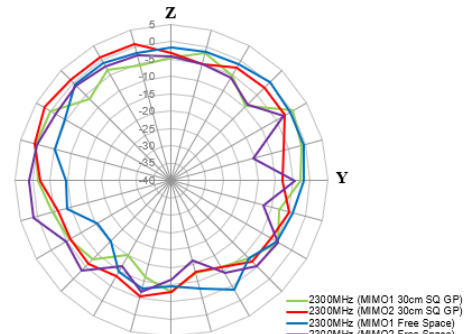
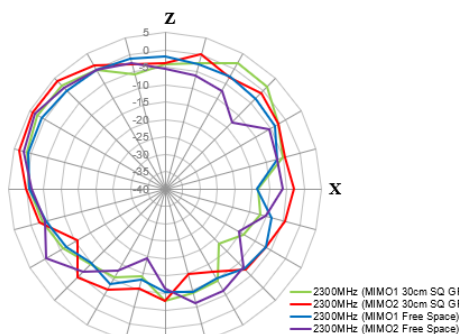
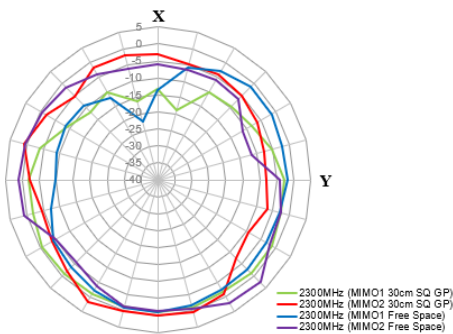

2500MHz

MIMO 1 – 30cmx30cm
Ground Plane

Azimuth = 0.0
Elevation = 0.0
Roll = -35.0

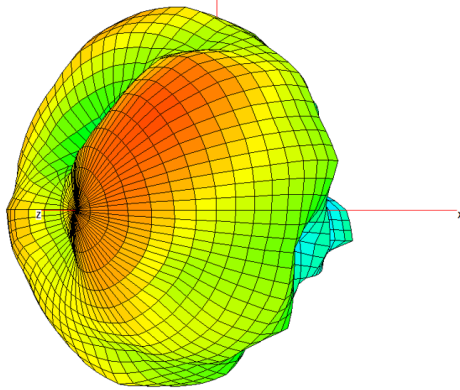

MIMO 2 – 30cmx30cm
Ground Plane

Azimuth = 0.0
Elevation = 0.0
Roll = -35.0

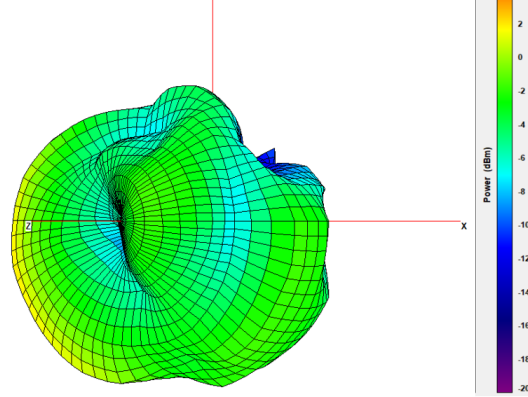

MIMO 1 – Free Space

Azimuth = 0.0
Elevation = 0.0
Roll = -35.0

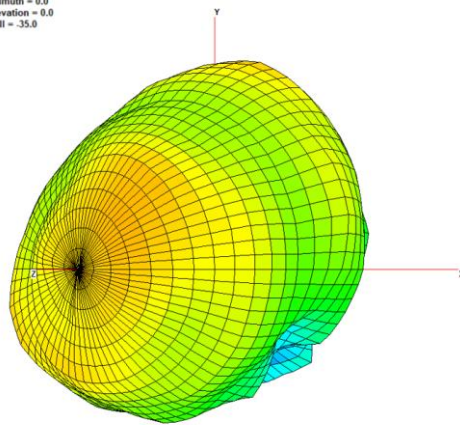

MIMO 2 – Free Space

Azimuth = 0.0
Elevation = 0.0
Roll = -35.0

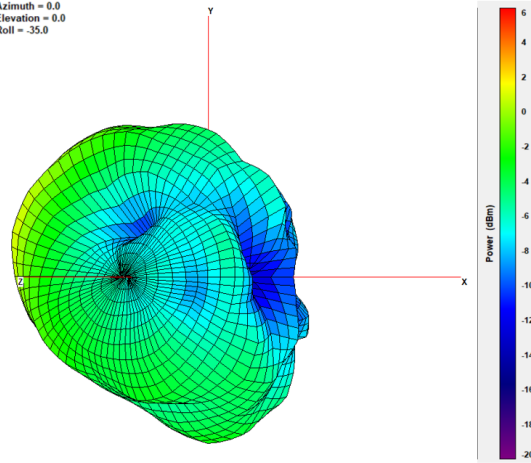

XY Plane

XZ Plane

YZ Plane

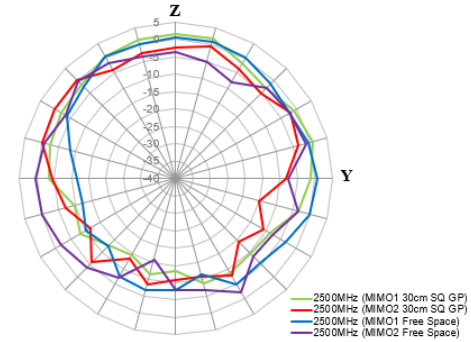
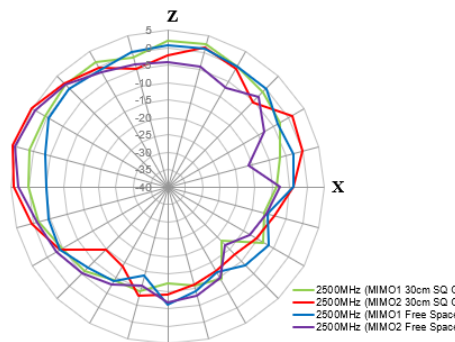
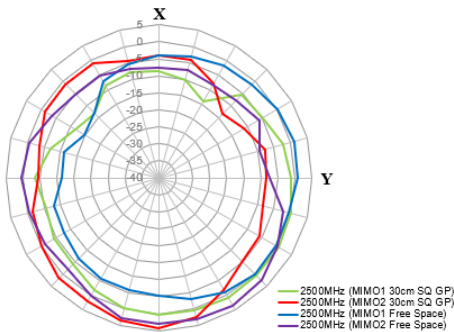

2570MHz

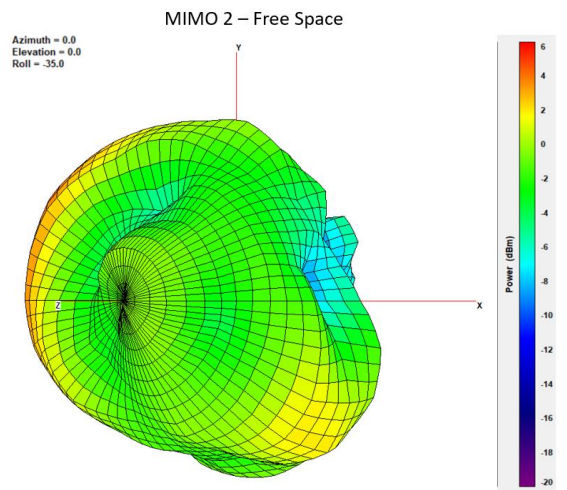
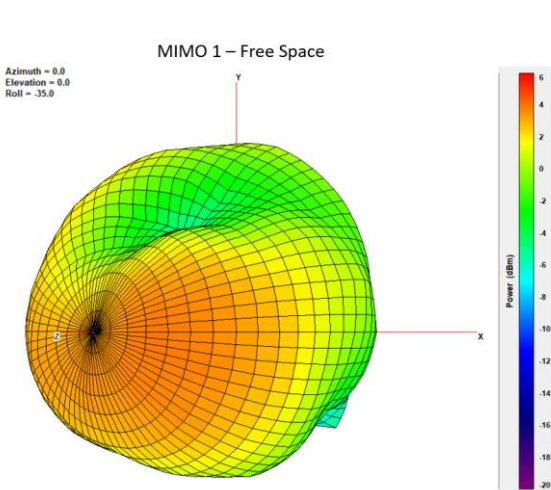
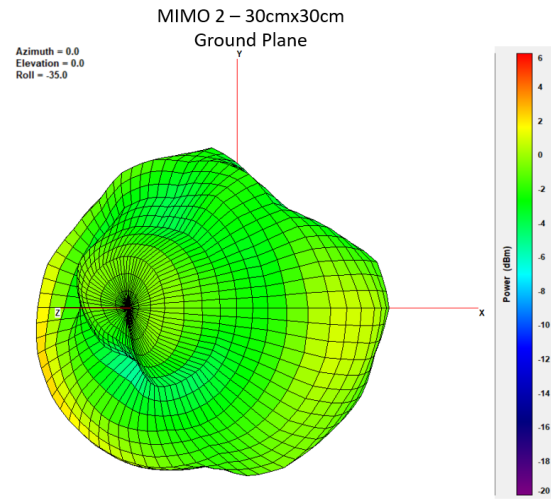
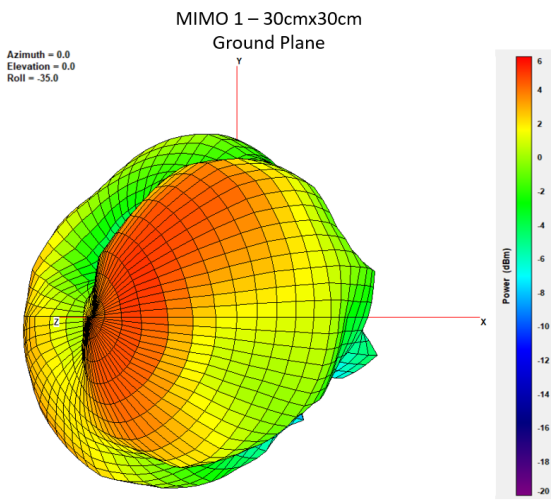

XY Plane

XZ Plane

YZ Plane

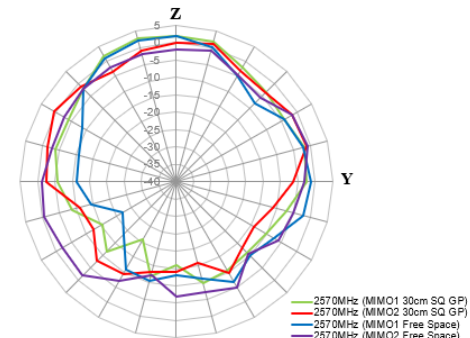
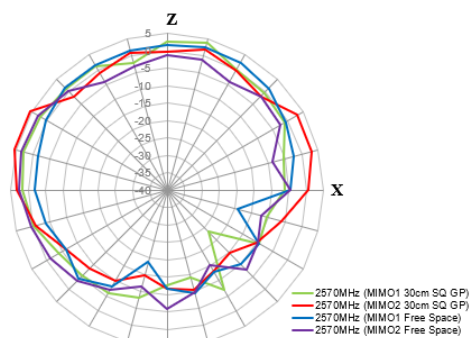
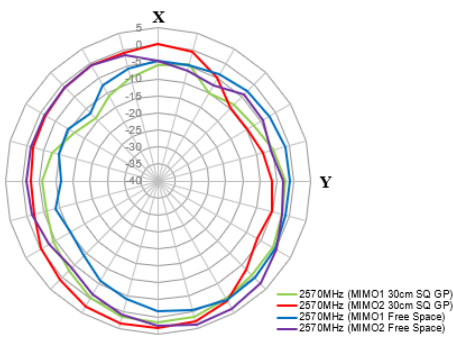

2700MHz

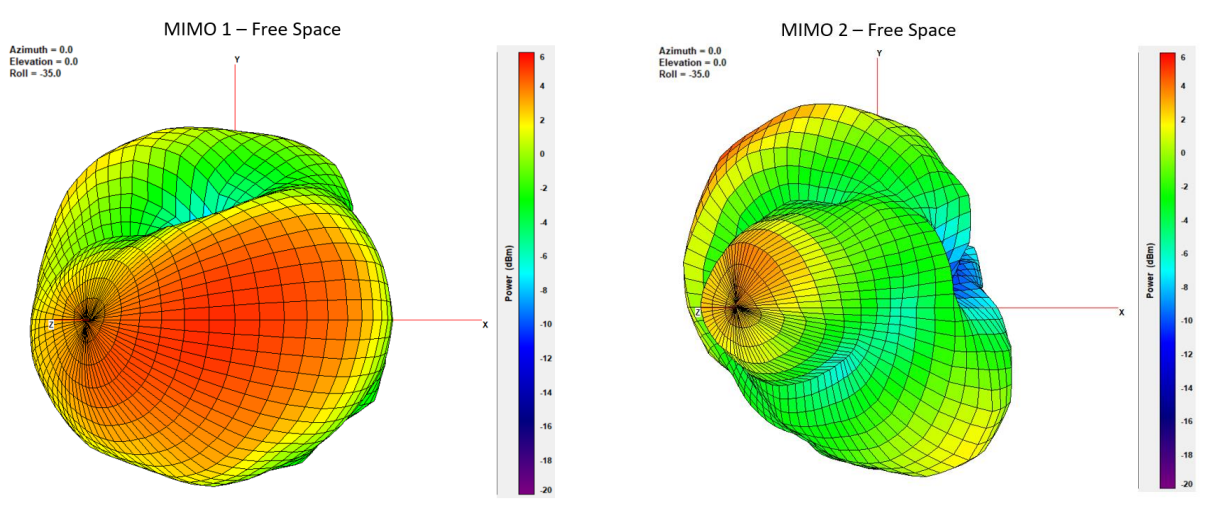
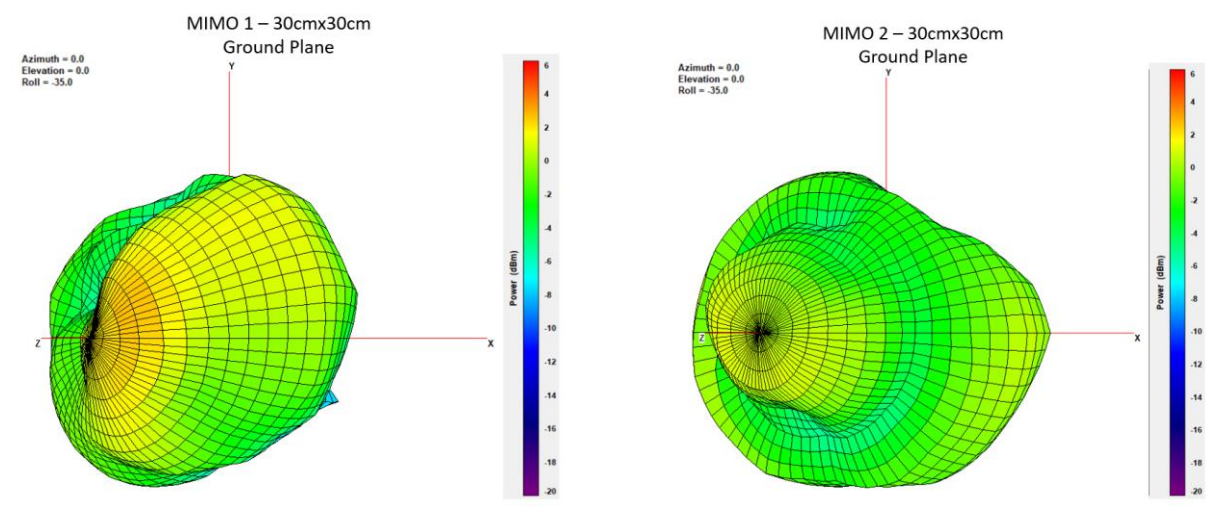

XY Plane
XZ Plane
YZ Plane

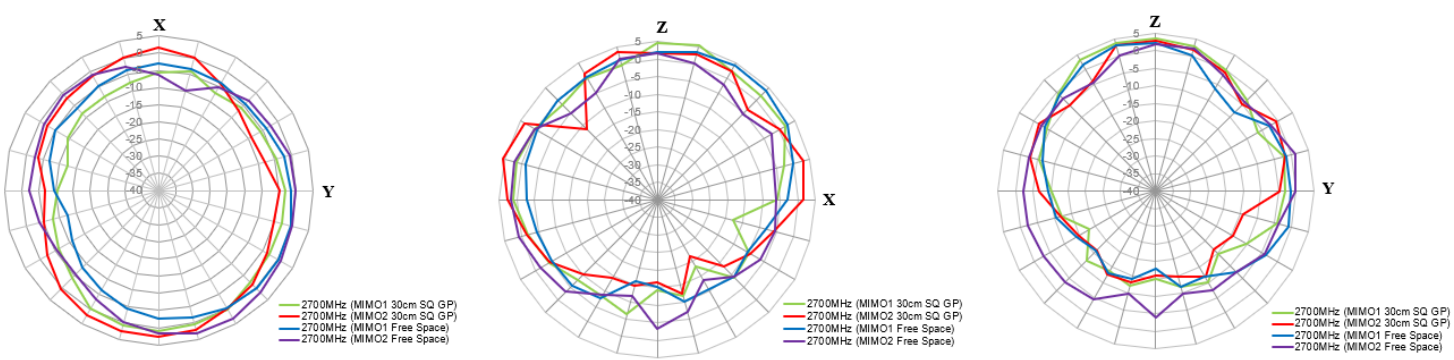

3200MHz

**MIMO 1 – 30cmx30cm
Ground Plane**

Azimuth = 0.0
Elevation = 0.0
Roll = -35.0

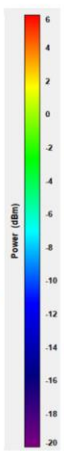
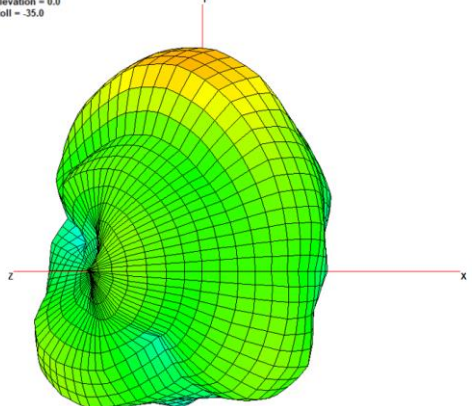

**MIMO 2 – 30cmx30cm
Ground Plane**

Azimuth = 0.0
Elevation = 0.0
Roll = -35.0

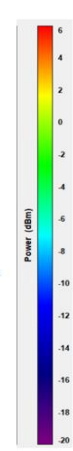
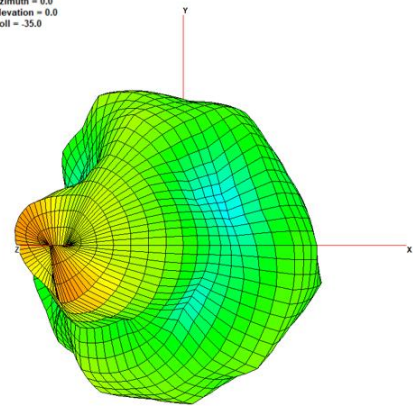

MIMO 1 – Free Space

Azimuth = 0.0
Elevation = 0.0
Roll = -35.0

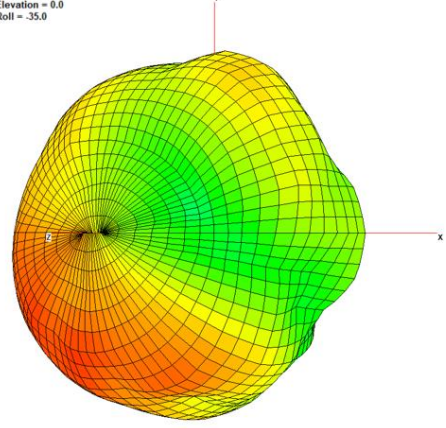

MIMO 2 – Free Space

Azimuth = 0.0
Elevation = 0.0
Roll = -35.0

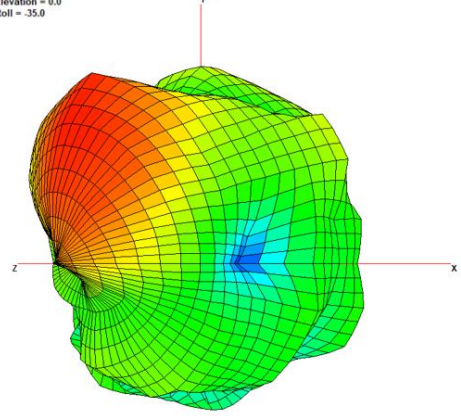

XY Plane

XZ Plane

YZ Plane

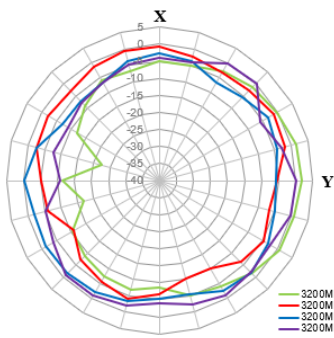

— 3200MHz (MIMO1 30cm SQ GP)
— 3200MHz (MIMO2 30cm SQ GP)
— 3200MHz (MIMO1 Free Space)
— 3200MHz (MIMO2 Free Space)

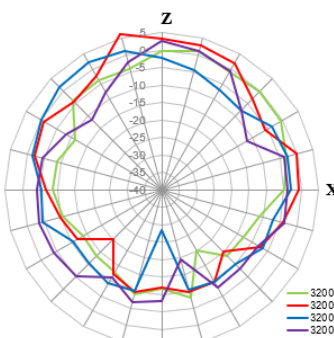

— 3200MHz (MIMO1 30cm SQ GP)
— 3200MHz (MIMO2 30cm SQ GP)
— 3200MHz (MIMO1 Free Space)
— 3200MHz (MIMO2 Free Space)

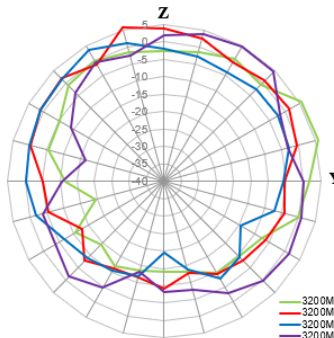

— 3200MHz (MIMO1 30cm SQ GP)
— 3200MHz (MIMO2 30cm SQ GP)
— 3200MHz (MIMO1 Free Space)
— 3200MHz (MIMO2 Free Space)

4200MHz

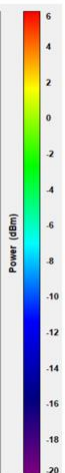
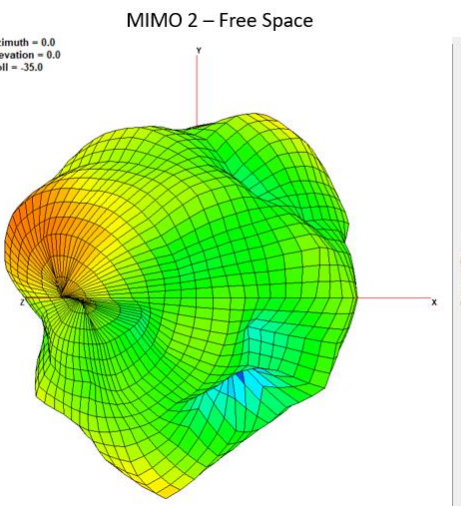
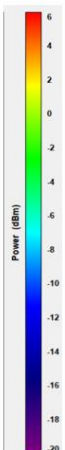
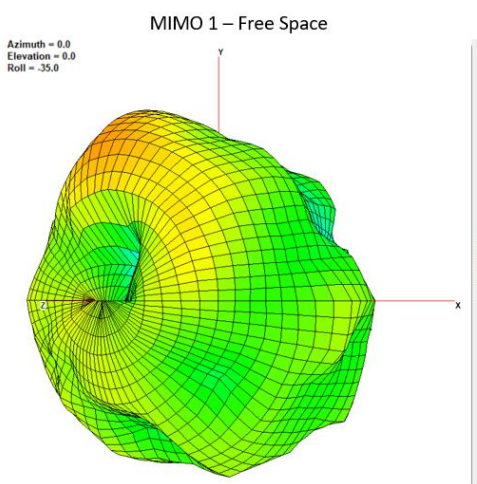
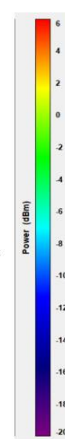
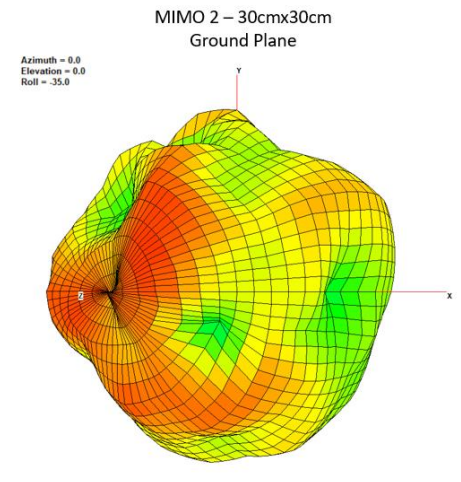
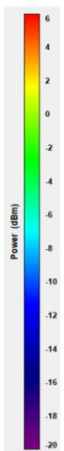
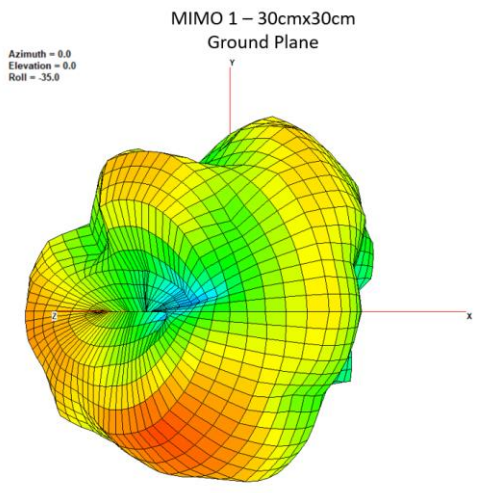

XY Plane

XZ Plane

YZ Plane

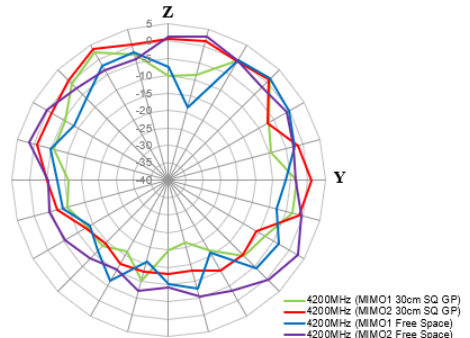
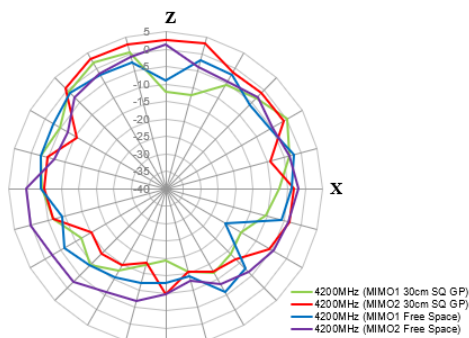
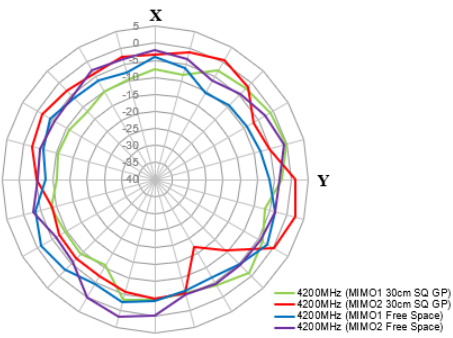

5150MHz

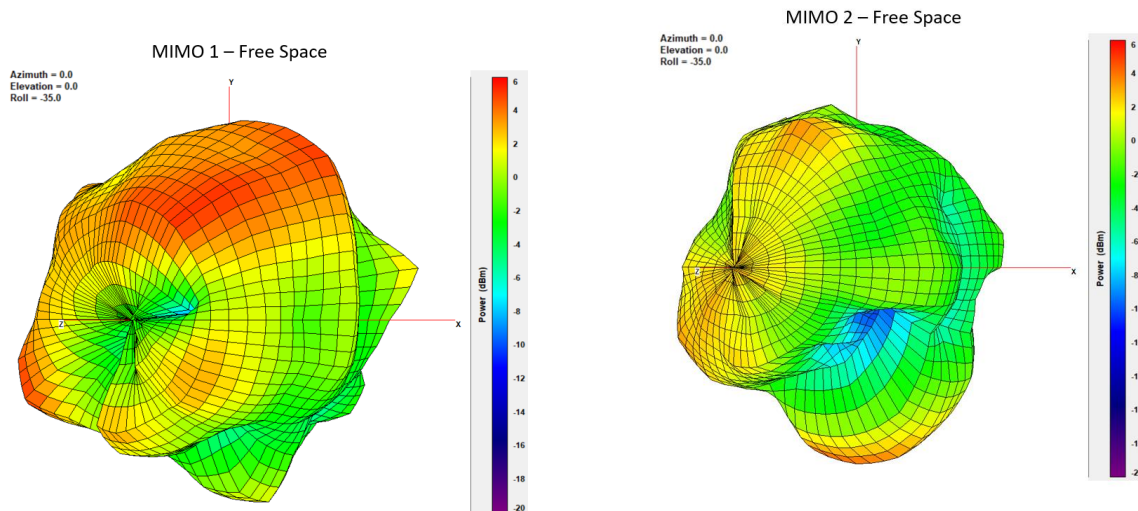
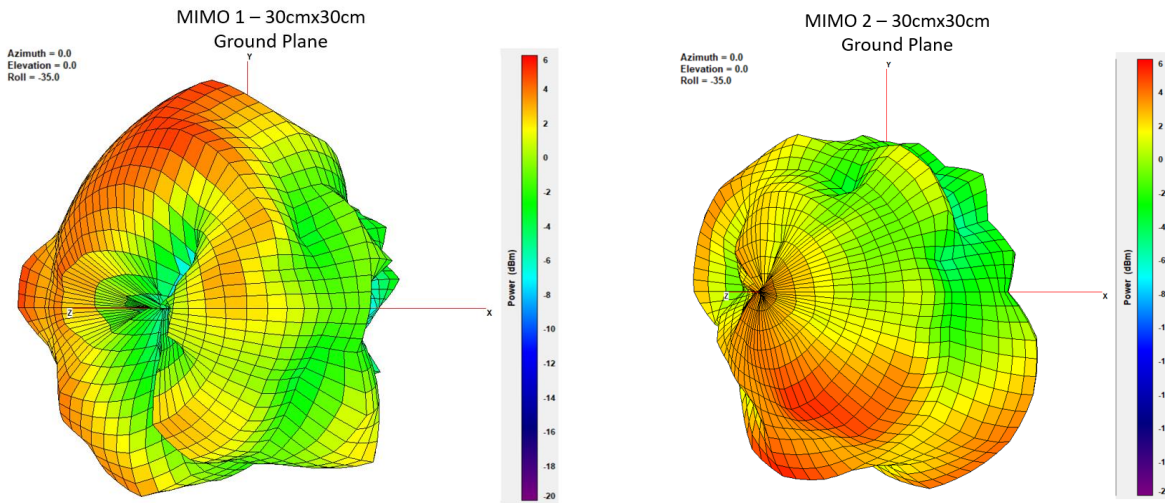

XY Plane

XZ Plane

YZ Plane

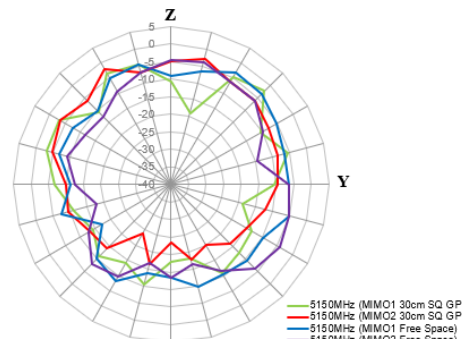
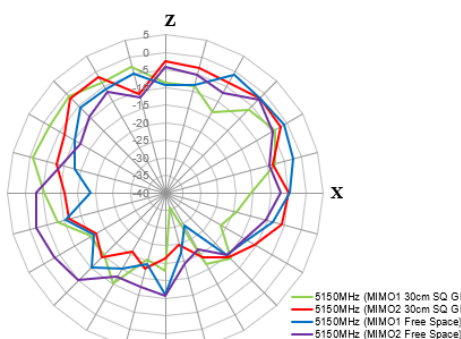
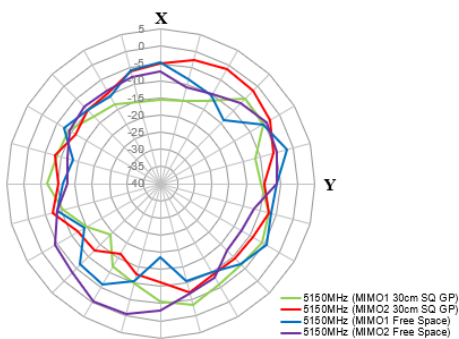

5550MHz

**MIMO 1 – 30cmx30cm
Ground Plane**

Azimuth = 0.0
Elevation = 0.0
Roll = -35.0

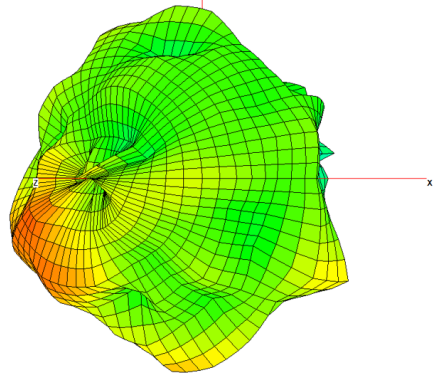

**MIMO 2 – 30cmx30cm
Ground Plane**

Azimuth = 0.0
Elevation = 0.0
Roll = -35.0

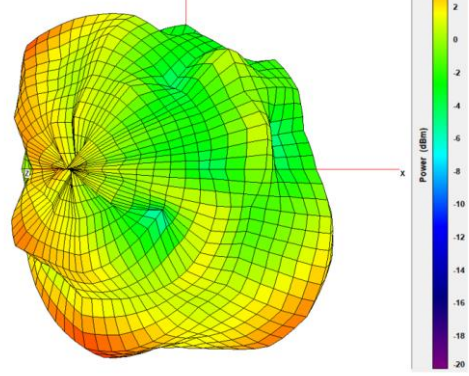

MIMO 1 – Free Space

Azimuth = 0.0
Elevation = 0.0
Roll = -35.0

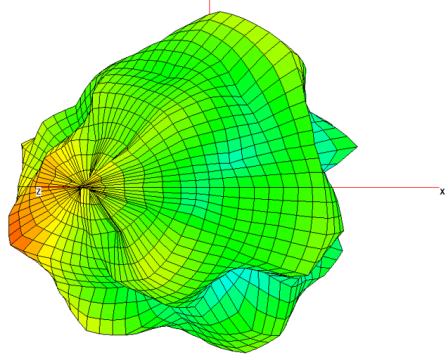

MIMO 2 – Free Space

Azimuth = 0.0
Elevation = 0.0
Roll = -35.0

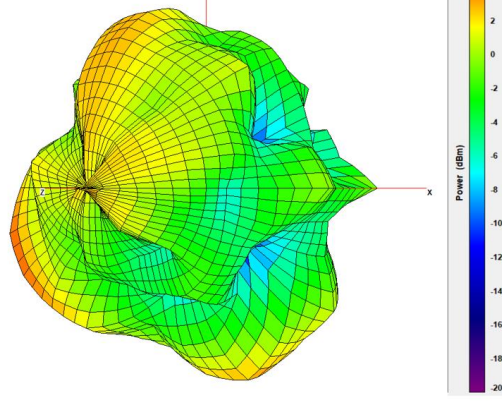

XY Plane

XZ Plane

YZ Plane

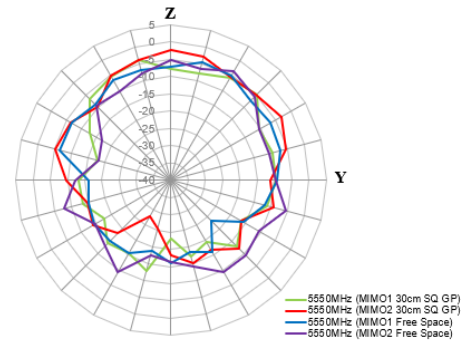
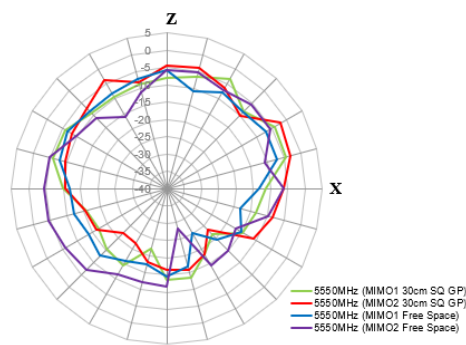
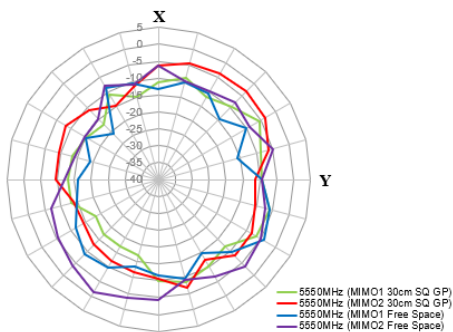

5. Mechanical Drawing

Top View

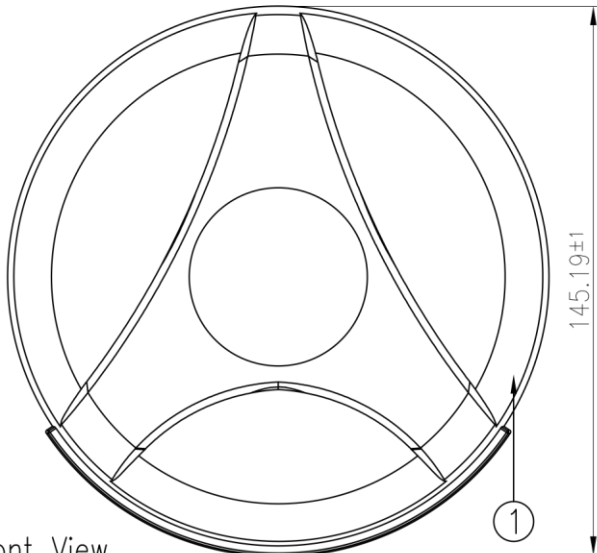

Bottom Thread View

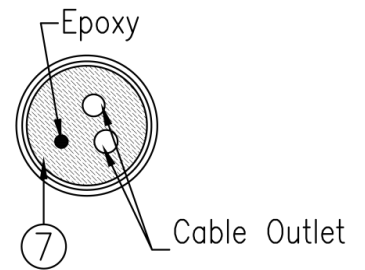

Front View

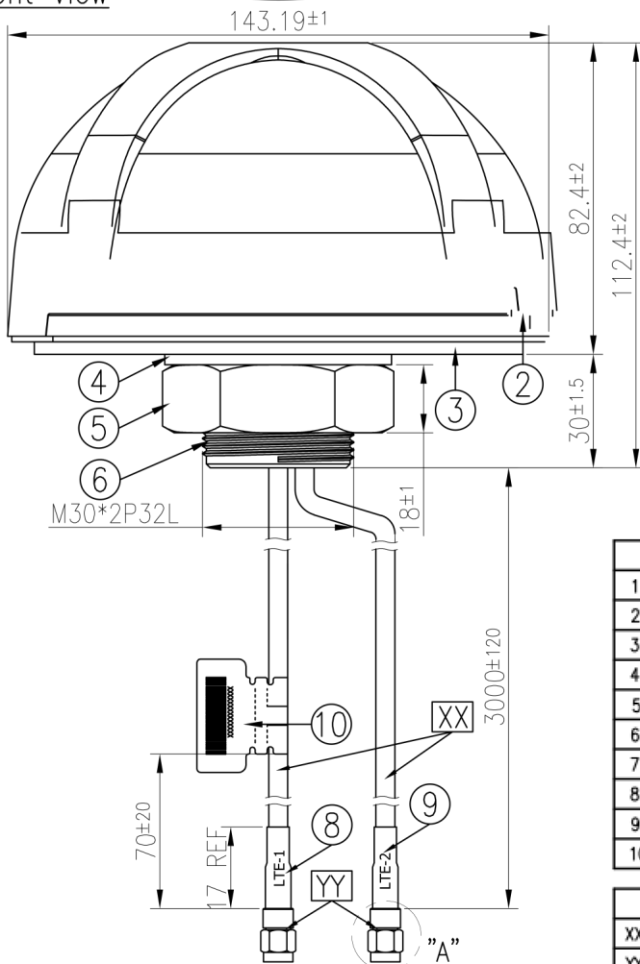

SMA(M)ST

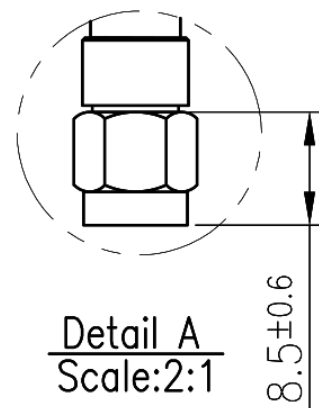

Detail A
Scale: 2:1

	Name	P/N	Material	Finish	QTY
1	Housing	000112L060015A	PC540	White	1
2	Closed Cell Foam	001011F030039A	DP-3060W	Black	1
3	M30 Nut	000411F000015A	Steel AISI 1215	Ni Plated	1
4	Washer	000411F010015A	Steel AISI 1215	Ni Plated	1
5	Waterproof Gasket	000711F000015A	Silicon Rubber	Black	1
6	Heat Shrink Tube	001311F010015A	PE	Black	2
7	2G/3G/4G MIMO1	001012L080015A	Coated Paper	Gray	1
8	2G/3G/4G MIMO2	001012L090015A	Coated Paper	White	1
9	3M Adhesive	001011F030015A	3M 9448 HK	White Liner	1
10	M30x 2 Thread 32L	000311F000015A	Zinc Alloy	Ni Plated	1

	Name	P/N	Spec	Finish	QTY
XX	Cable Type	301413A000015A	CFD200	Black	2
YY	Connector Type	200212G010015A	SMA(M)ST	Gold	2

6. Installation

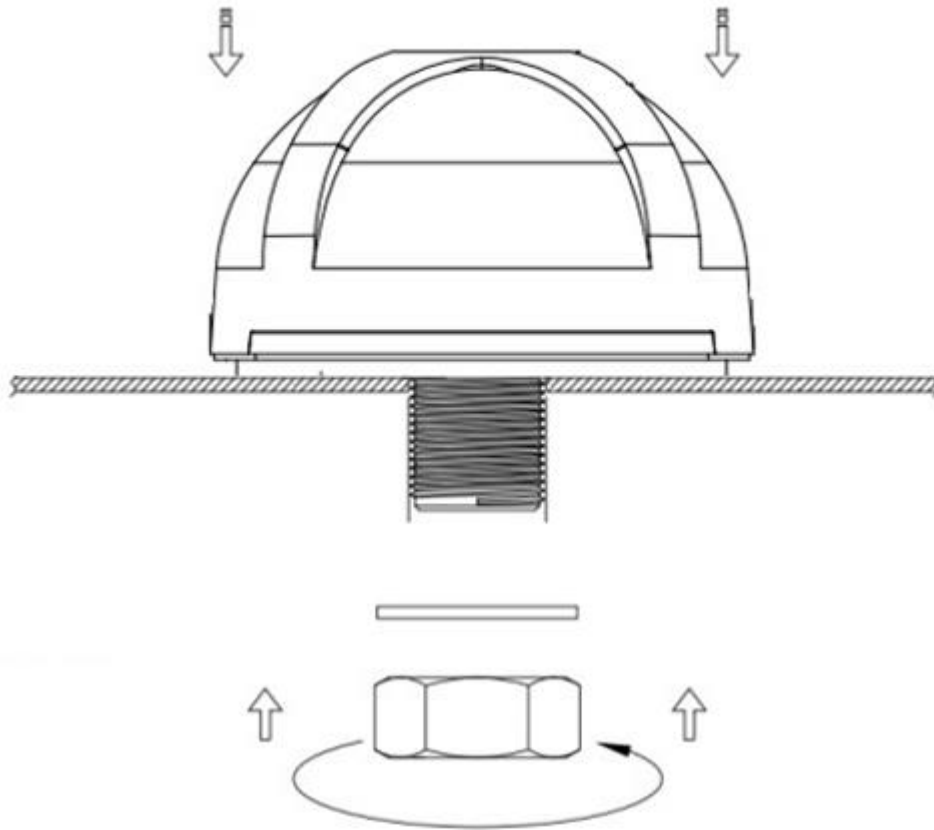

Recommended torque for mounting: 5-7Nm

(Torque value obtained with antenna mounted on 1mm thick SUS-316 bracket)

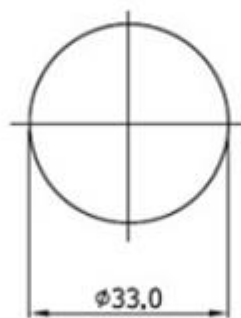

**Recommended
Mounting Hole**

Unit:mm

7. Packaging

1pc MA741.A.BI.001 per box
 Box Dimensions – 185 x 170 x 177mm
 Weight – 1.4Kg

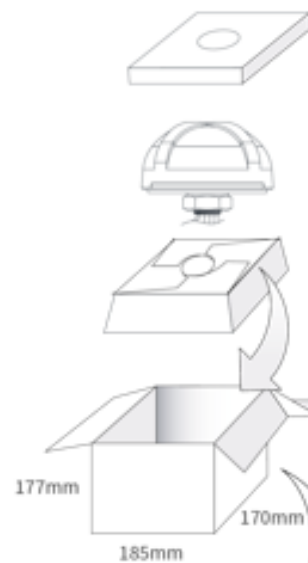

8pcs MA741.A.BI.001 per Carton
 Carton Dimensions – 384 x 350 x 388mm
 Weight – 11.2Kg

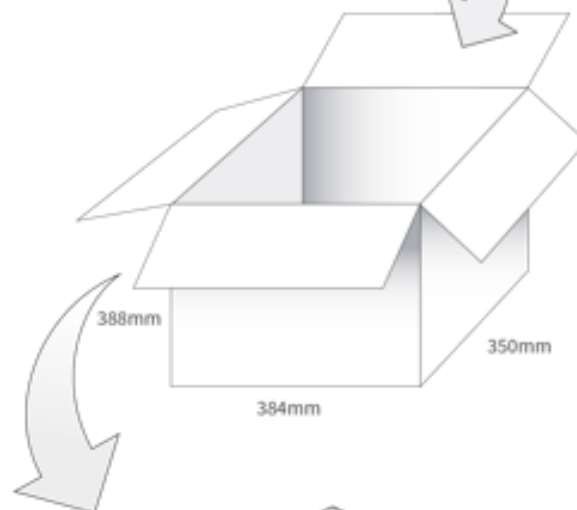

32 Cartons per pallet
 Pallet Dimensions – 1100 x 1100mm

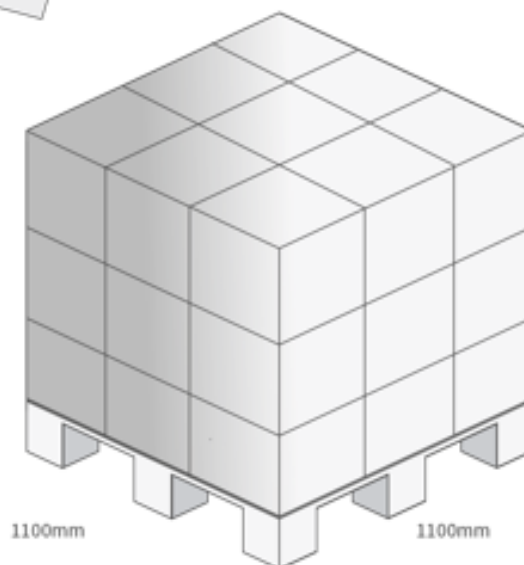

Changelog for the datasheet

SPE-24-8-002 – MA741.A.BI.001

Revision: B (Current Version)	
Date:	2024-02-21
Changes:	Updated test setup photos
Changes Made by:	Gary West

Previous Revisions

Revision: A (Original First Release)	
Date:	2024-01-03
Notes:	
Author:	Jack Conroy



TAOGLAS®

www.taoglas.com



Mouser Electronics

Authorized Distributor

Click to View Pricing, Inventory, Delivery & Lifecycle Information:

[Taoglas:](#)

[MA741.W.A.BI.001](#)