



Datasheet

Pantheon MA741 2-in-1 Permanent Mount Antenna

Part No:
MA741.B.BI.001

Description:

Pantheon Antenna 2-in-1 MA741
Permanent Mount 5G/4G *2 MIMO

Features:

2 x 5G/4G Cellular Antennas (MIMO)
IP67 Waterproof
High Efficiency / Peak Gain Outdoor Antenna
Dimensions: Ø143.2 x 82.4mm
Cables: 3m CFD-200 as standard, Fully customizable
Connectors: SMA(M) as standard, Fully customizable
RoHs & Reach Compliant

1. Introduction	3
2. Specifications	4
3. Antenna Characteristics	7
4. Radiation Patterns	9
5. Mechanical Drawing	27
6. Installation	28
7. Packaging	29
<hr/>	
Changelog	30

Taoglas makes no warranties based on the accuracy or completeness of the contents of this document and reserves the right to make changes to specifications and product descriptions at any time without notice. Taoglas reserves all rights to this document and the information contained herein. Reproduction, use or disclosure to third parties without express permission is strictly prohibited.



1. Introduction



The Taoglas MA741 Pantheon 2-in-1 antenna is an omnidirectional heavy-duty, fully IP67 waterproof external M2M antenna for use in telematics, transportation, and remote monitoring applications. This unique antenna delivers powerful MIMO antenna technology for 5G/4G Cellular.

The Pantheon MA741 covers all 5G bands from 600-6000MHz, exhibiting excellent performance at key 5G bands such as band 71(617MHz) and the repurposed CBRS and C-band frequencies from 3400-4200MHz. This ensures the Pantheon is prepared for mission critical applications.

Typical Applications Include:

- Public Safety
- Passenger Bus and Rail Services
- Digital Signage
- Commercial Transportation and Fleet Management

All five high-performance antennas are integrated into an extremely robust IP67 permanent mount compact antenna package measuring just 82.4mm in height and 143.2mm in diameter.

The antenna has its own ground-plane and can radiate on any mounting environment like metal or plastic without affecting performance. The cables are low loss allowing for lengths of up to 10 meters (32' and 9.70"), critical for buses, trains, and other commercial transport applications.

Customized cables and connector version available, contact your regional Taoglas customer support team for further information. The enclosure is also available in White, MA741.W.B.BI.001.

2. Specifications

5G/4G MIMO									
Band	Frequency (MHz)			Efficiency (%)	Average Gain (dB)	Peak Gain (dBi)	VSWR	Impedance	Polarization
5G NR/4G Band 5,8,12,13,14,17,18,20,26,27,28, 29,71	617~960	MIMO 1	Free Space	61	-2.2	3.3	3 Max	50Ω	Linear
			30X30cm GroundPlane	35	-1.7	3.5			
		MIMO 2	Free Space	69	-4.7	2.5			
			30X30cm GroundPlane	26	-6.1	1.4			
5G NR/4G Band 21,32,74,75,76	1427~1518	MIMO 1	Free Space	36	-4.4	2.8			
			30X30cm GroundPlane	21	-4.8	2.8			
		MIMO 2	Free Space	34	-7.0	-0.5			
			30X30cm GroundPlane	18	-7.8	0.5			
4G/3G Band 1,2,3,4,9,23,25,35,39,66	1710~2200	MIMO 1	Free Space	58	-2.4	3.1			
			30X30cm GroundPlane	48	-2.4	5.4			
		MIMO 2	Free Space	57	-3.2	3.2			
			30X30cm GroundPlane	47	-3.3	4.4			
Wi-Fi 2400	2400~2500	MIMO 1	Free Space	44	-3.6	2.1			
			30X30cm GroundPlane	64	-3.2	4.0			
		MIMO 2	Free Space	47	-1.9	5.2			
			30X30cm GroundPlane	67	-1.8	5.8			
4G/3G Band 7,38,41	2490~2690	MIMO 1	Free Space	51	-3.0	4.6			
			30X30cm GroundPlane	65	-2.6	4.7			
		MIMO 2	Free Space	55	-1.9	5.4			
			30X30cm GroundPlane	68	-1.7	6.2			
5G NR/4G Band 22,42,43,48,77,78,79	3300~5000	MIMO 1	Free Space	34	-5.2	5.8			
			30X30cm GroundPlane	41	-5.1	8.1			
		MIMO 2	Free Space	35	-4.0	4.7			
			30X30cm GroundPlane	42	-3.9	6.8			
LTE5200/ Wi-Fi 5800	5150~5925	MIMO 1	Free Space	16	-8.1	1.2			
			30X30cm GroundPlane	23	-8.2	2.4			
		MIMO 2	Free Space	16	-6.5	3.0			
			30X30cm GroundPlane	22	-6.7	3.3			

Mechanical	
Antenna Dimensions	Height 82.4mm x Diameter 143.19mm
Casing	Wonderloy PC-540 PC/ABS Alloy
Waterproof	IP67
5G/4G MIMO 1	3m CFD-200 SMA(M)
5G/4G MIMO 2	3m CFD-200 SMA(M)
Base and thread	CAN10 Zinc Alloy
Thread diameter	M30 x 2 (30mm)
Nut	Nickel Plated Steel
Foam	3M 9448HK
Weight(kg)	1.16Kg
Recommended Torque for Mounting	5-7Nm
Enviornmental	
Operation Temperature	-40°C to 85°C
Storage Temperature	-40°C to 90°C
Humidity	Non-condensing 65°C 95% RH

5G/4G Bands			
Band Number	5GNR / FR1 / LTE / LTE-Advanced / WCDMA / HSPA / HSPA+ / TD-SCDMA		
	Uplink	Downlink	Covered
1	UL: 1920 to 1980	DL: 2110 to 2170	✓
2	UL: 1850 to 1910	DL: 1930 to 1990	✓
3	UL: 1710 to 1785	DL: 1805 to 1880	✓
4	UL: 1710 to 1755	DL: 2110 to 2155	✓
5	UL: 824 to 849	DL: 869 to 894	✓
7	UL: 2500 to 2570	DL: 2620 to 2690	✓
8	UL: 880 to 915	DL: 925 to 960	✓
9	UL: 1749.9 to 1784.9	DL: 1844.9 to 1879.9	✓
11	UL: 1427.9 to 1447.9	DL: 1475.9 to 1495.9	✓
12	UL: 699 to 716	DL: 729 to 746	✓
13	UL: 777 to 787	DL: 746 to 756	✓
14	UL: 788 to 798	DL: 758 to 768	✓
17	UL: 704 to 716	DL: 734 to 746	✓
18	UL: 815 to 830	DL: 860 to 875	✓
19	UL: 830 to 845	DL: 875 to 890	✓
20	UL: 832 to 862	DL: 791 to 821	✓
21	UL: 1447.9 to 1462.9	DL: 1495.9 to 1510.9	✓
22	UL: 3410 to 3490	DL: 3510 to 3590	✓
23	UL: 2000 to 2020	DL: 2180 to 2200	✓
24	UL: 1625.5 to 1660.5	DL: 1525 to 1559	✓
25	UL: 1850 to 1915	DL: 1930 to 1995	✓
26	UL: 814 to 849	DL: 859 to 894	✓
27	UL: 807 to 824	DL: 852 to 869	✓
28	UL: 703 to 748	DL: 758 to 803	✓
29	UL: -	DL: 717 to 728	✓
30	UL: 2305 to 2315	DL: 2350 to 2360	✓
31	UL: 452.5 to 457.5	DL: 462.5 to 467.5	✗
32	UL: -	DL: 1452 - 1496	✓
35		1850 to 1910	✓
38		2570 to 2620	✓
39		1880 to 1920	✓
40		2300 to 2400	✓
41		2496 to 2690	✓
42		3400 to 3600	✓
43		3600 to 3800	✓
48		3550 to 3700	✓
66	UL: 1710-1780	DL: 2110-2200	✓
71		617 to 698	✓
74/75/76		1427 to 1518	✓
78		3300 to 3800	✓
79		4400 to 5000	✓
85	698-716	728-746	✓

3. Antenna Characteristics

3.1 Return Loss

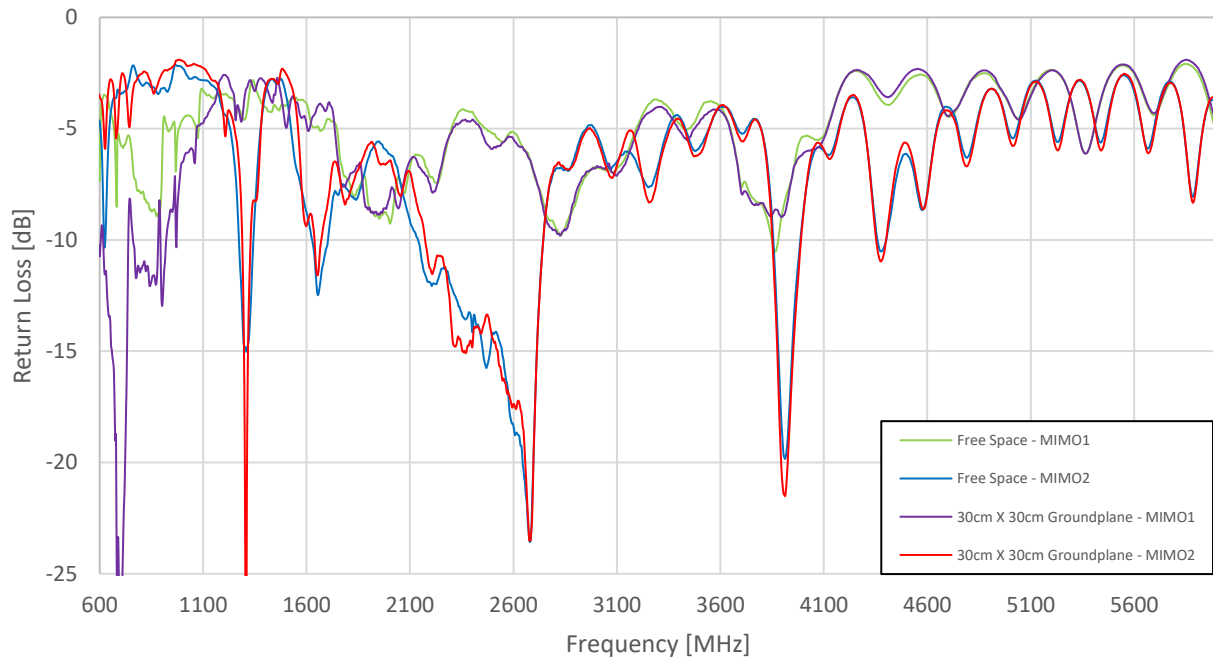

3.2 Efficiency

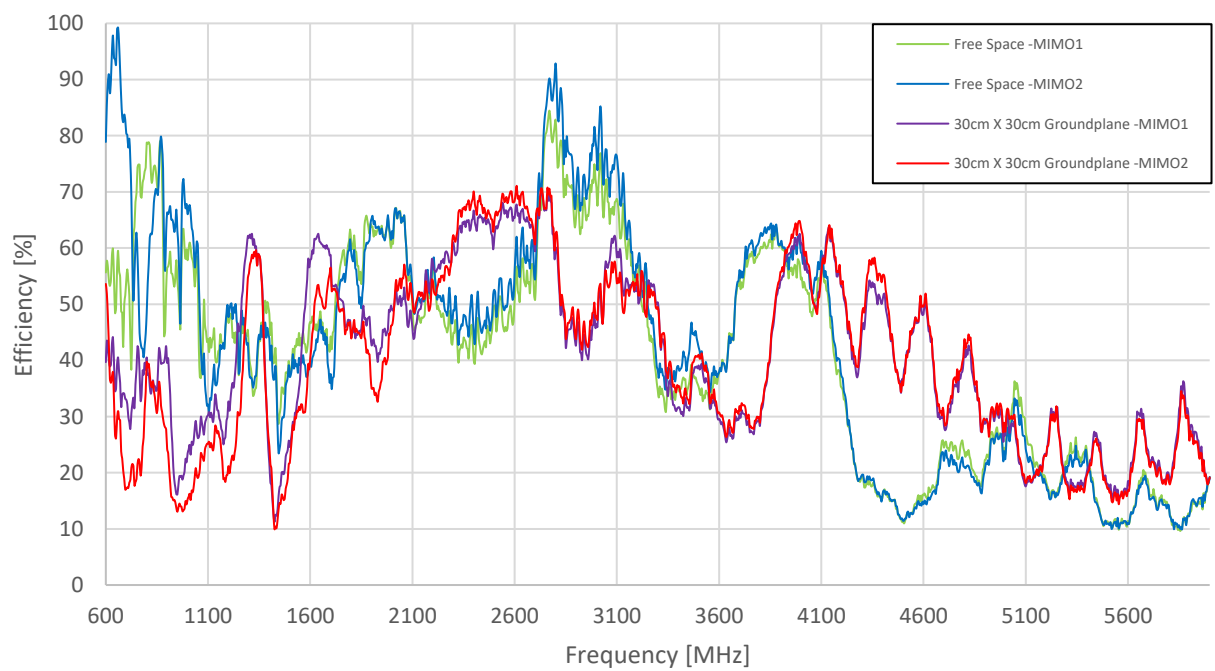

3.3 Peak Gain

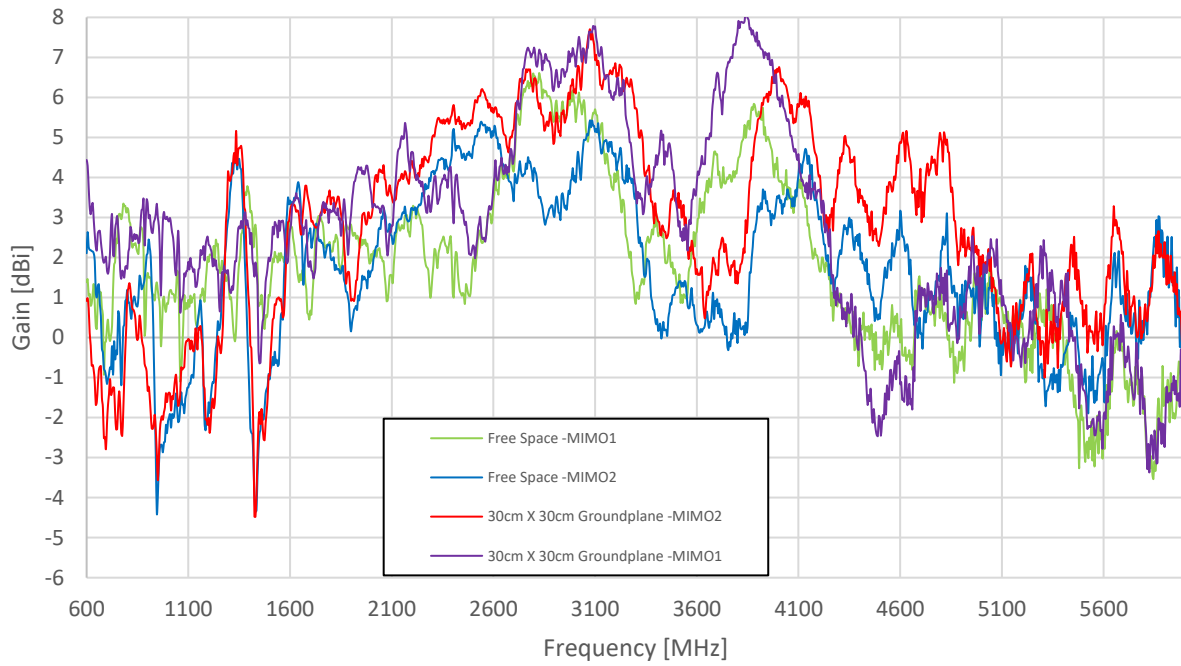

3.4 Average Gain

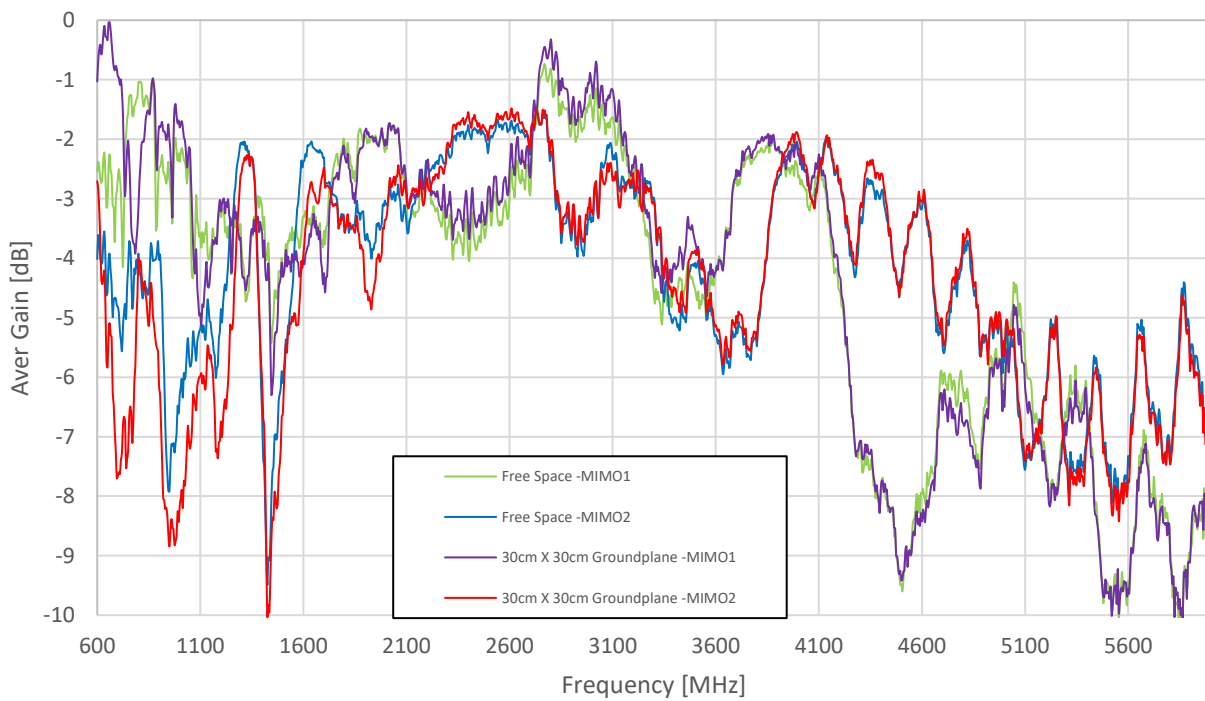

4. Radiation Patterns

4.1 Test Setup

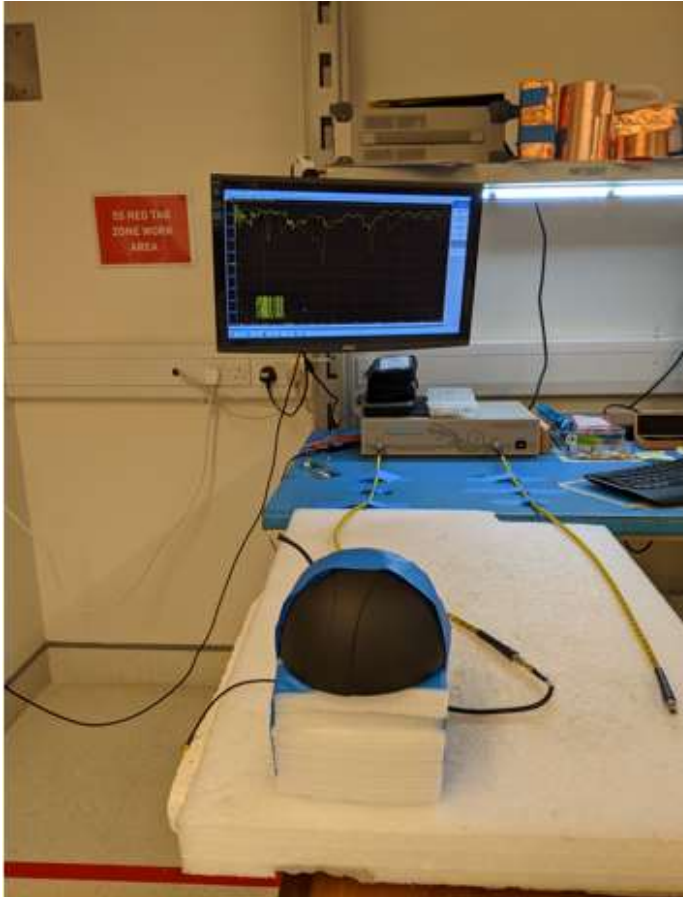

VNA Test Set-up

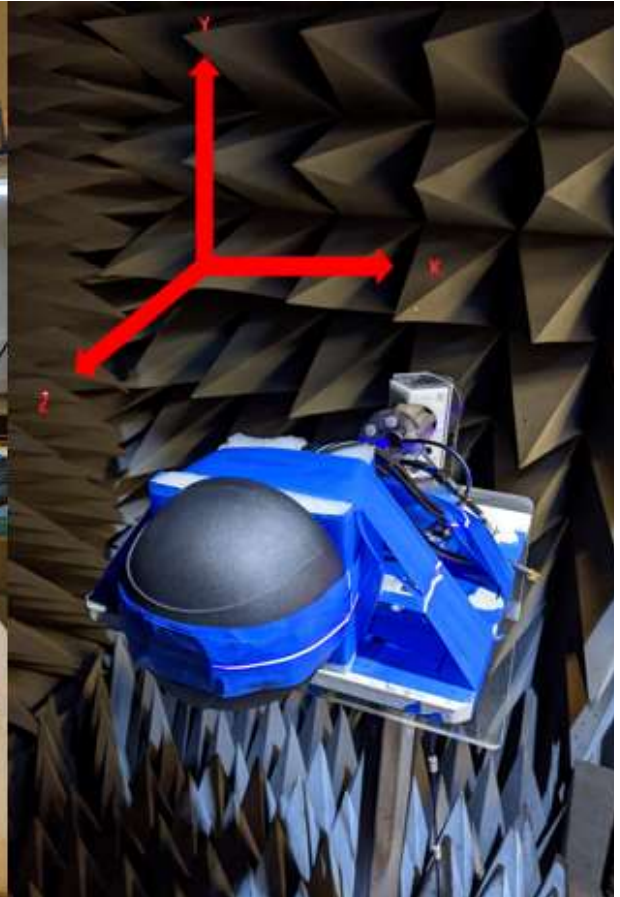

Chamber Test Set-up

4.2 705MHz 3D and 2D Cellular Radiation Patterns

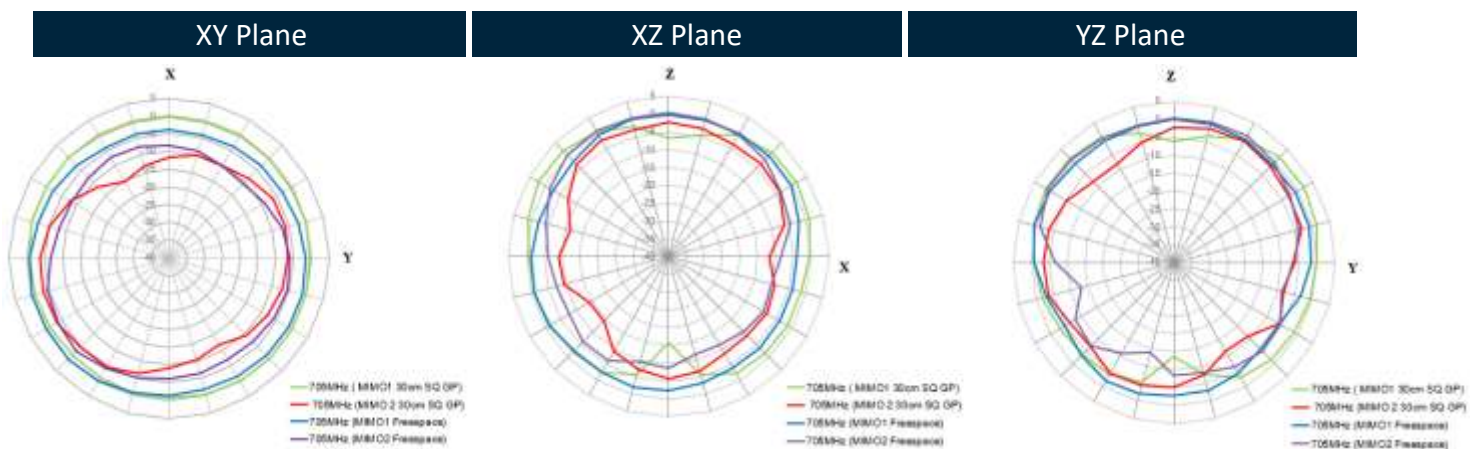
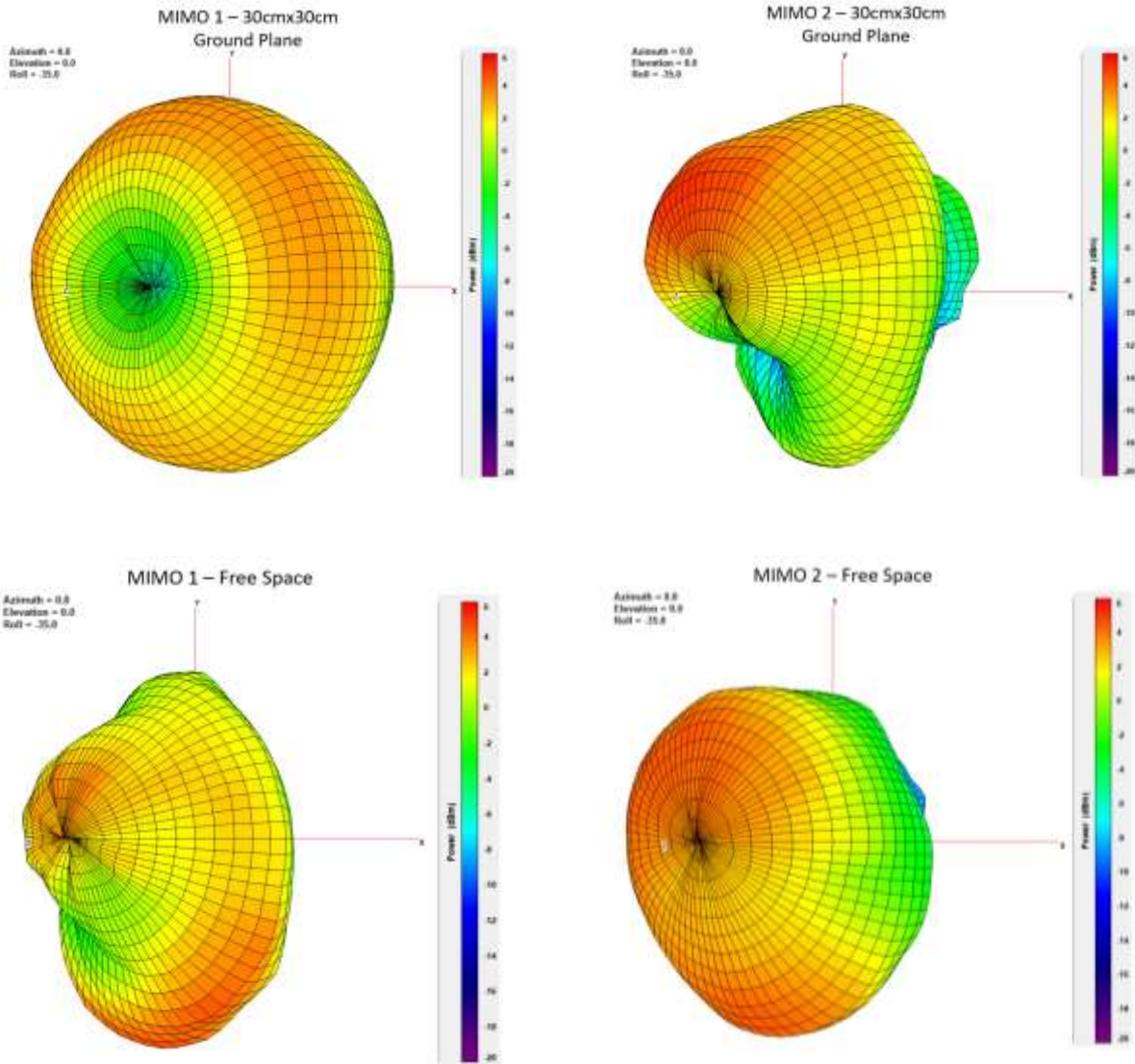

750MHz

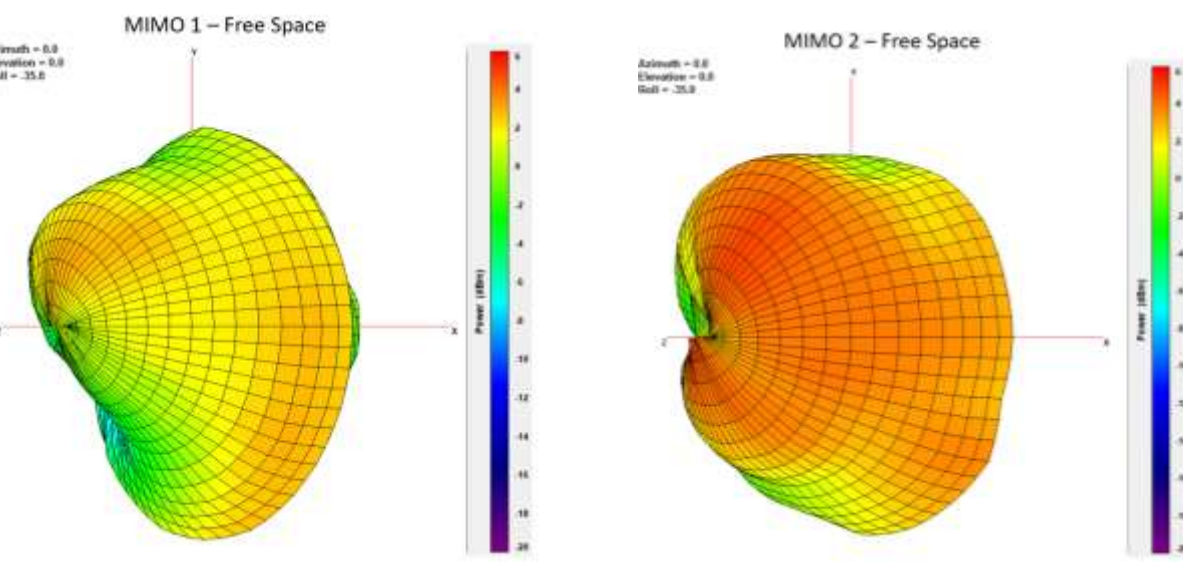
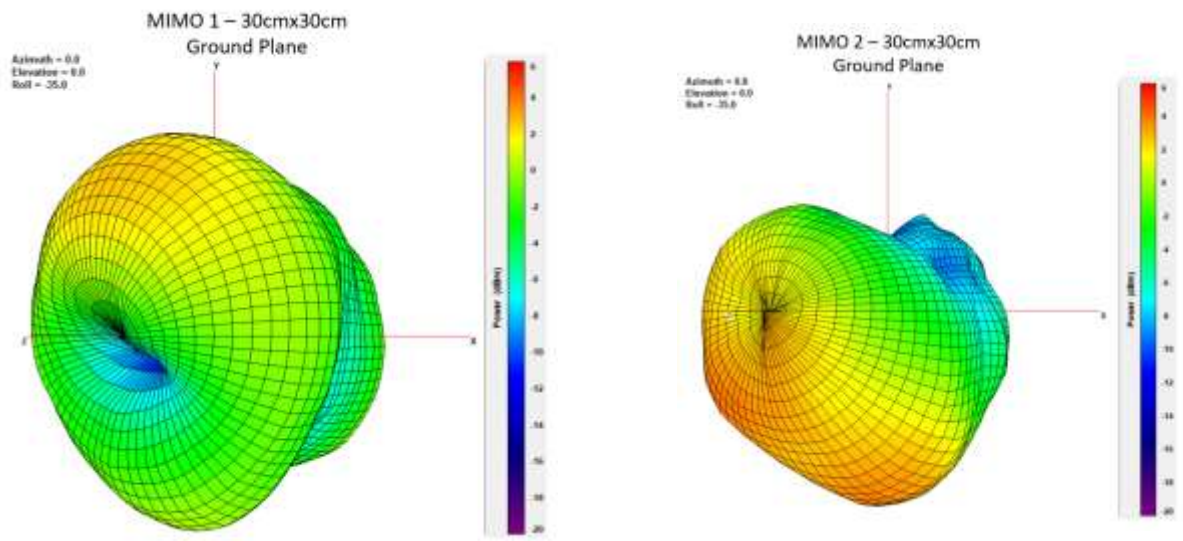

XY Plane
XZ Plane
YZ Plane

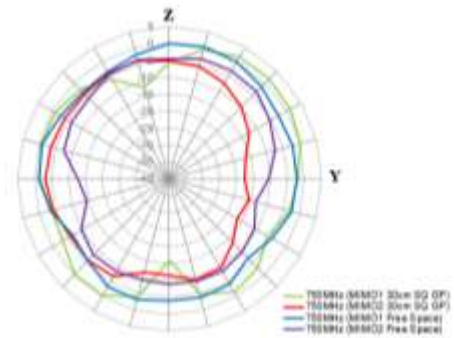
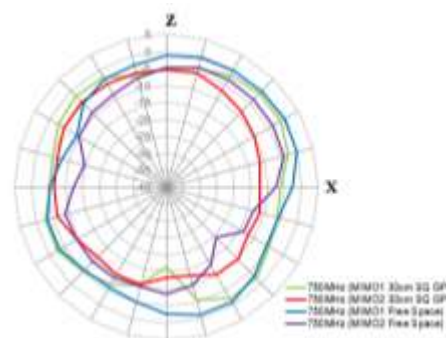
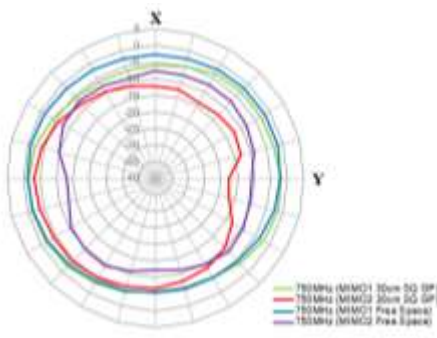

825MHz

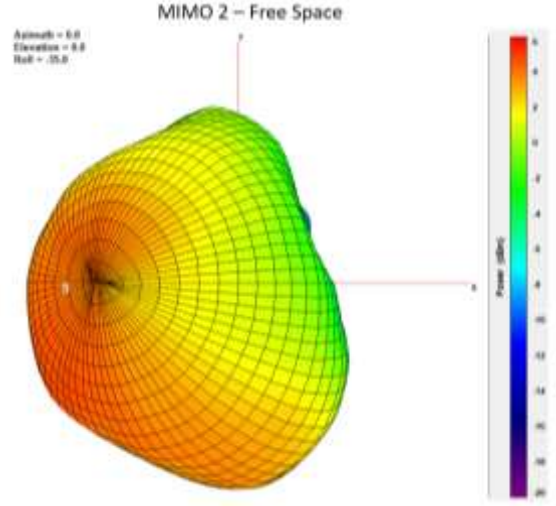
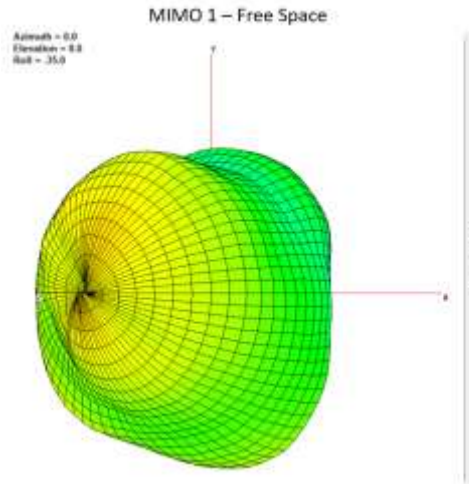
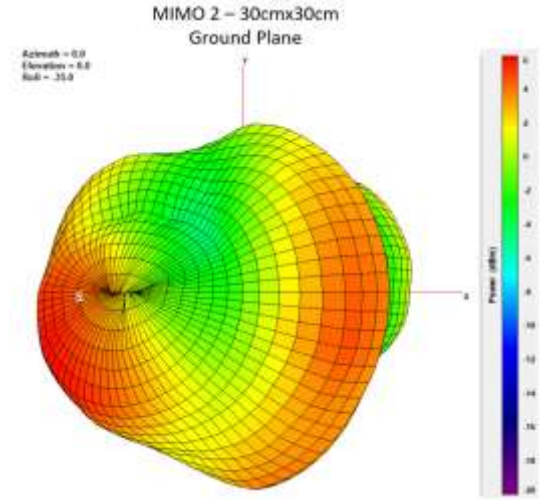
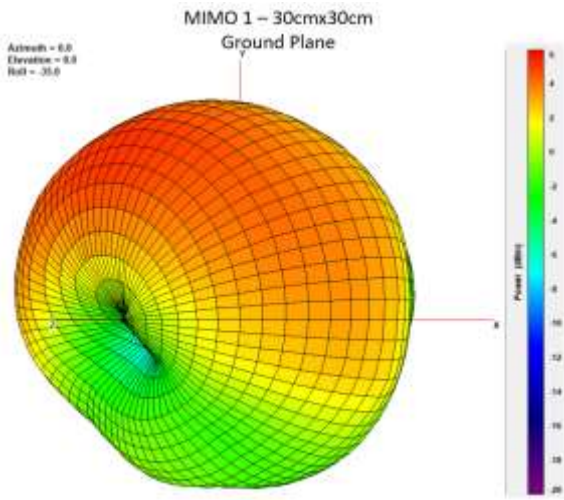

XY Plane

XZ Plane

YZ Plane

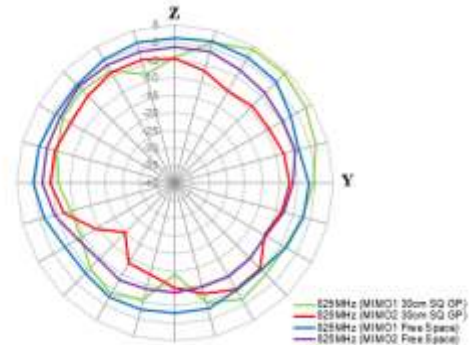
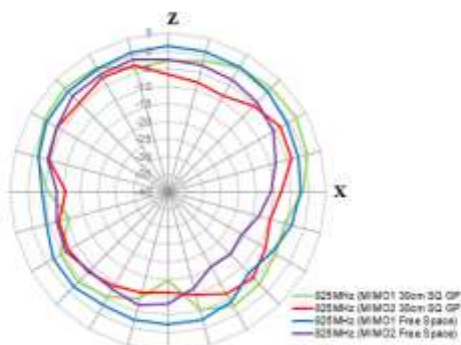
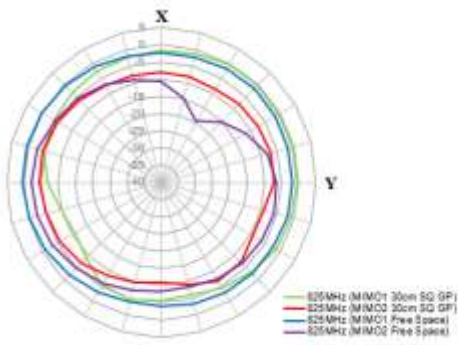

880MHz

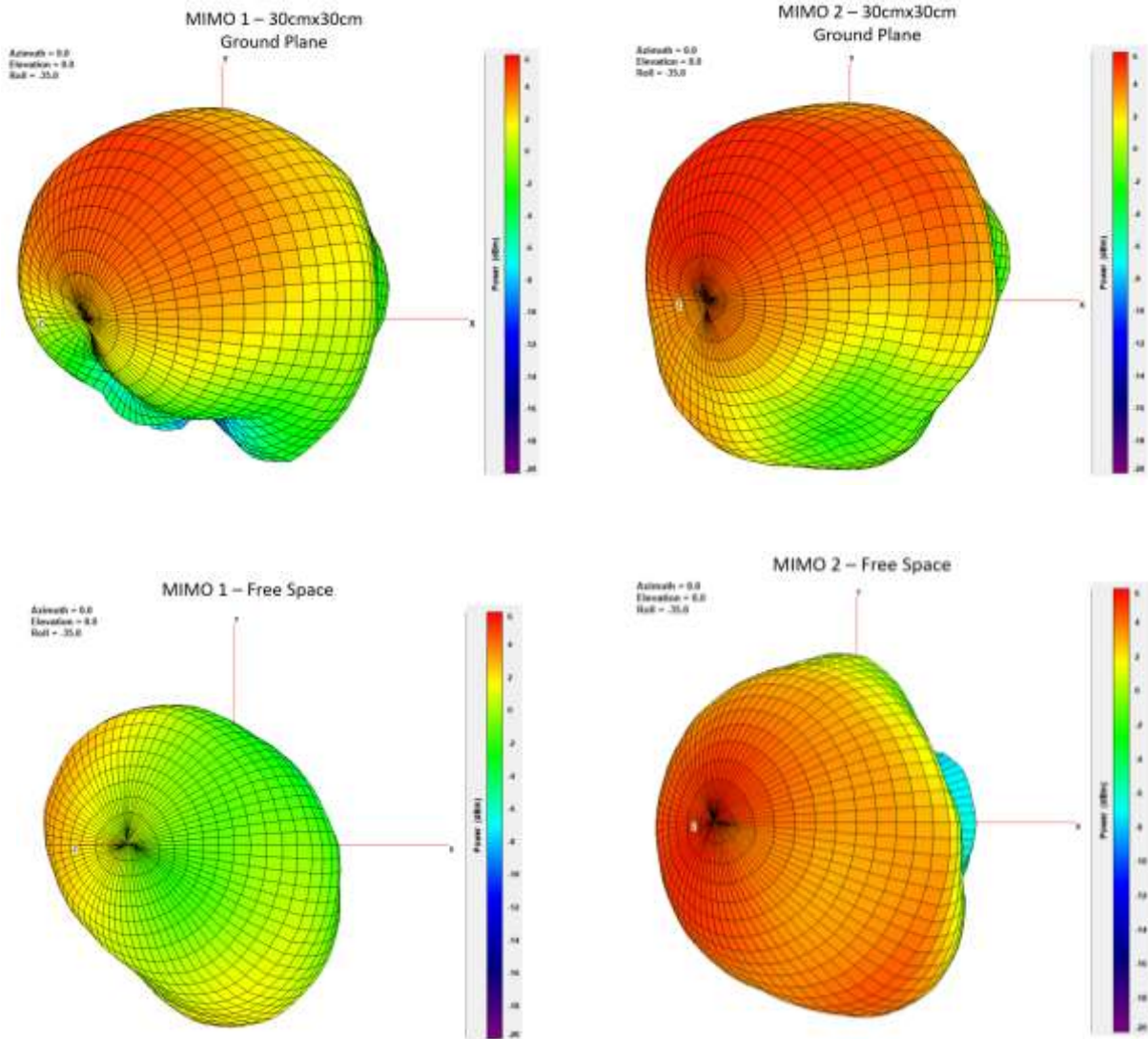

XY Plane

XZ Plane

YZ Plane

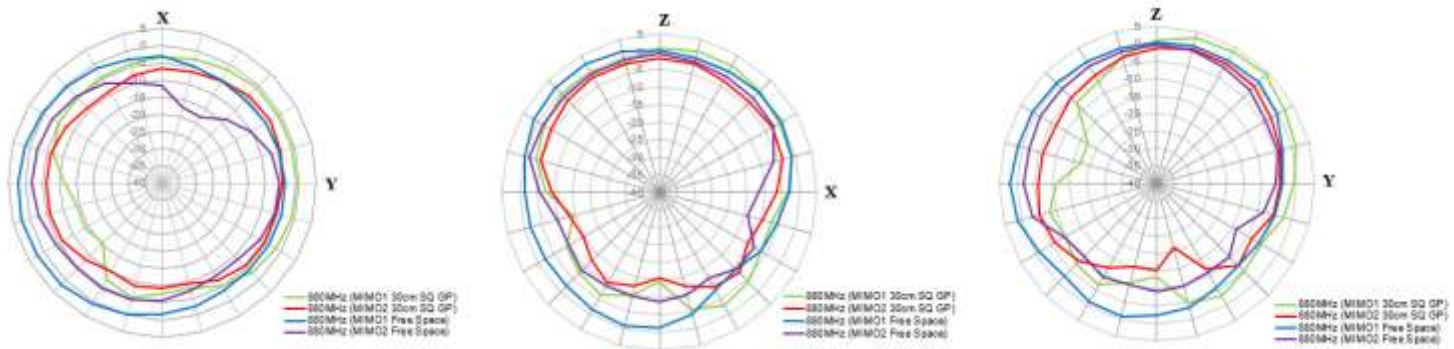

960MHz

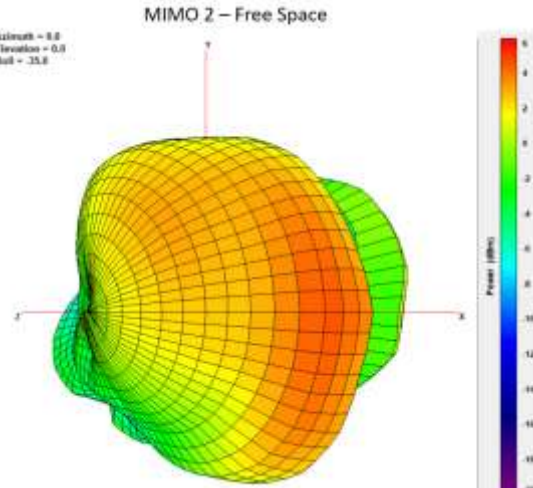
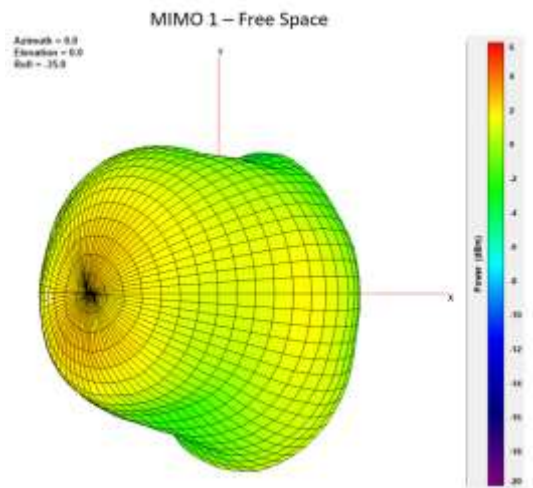
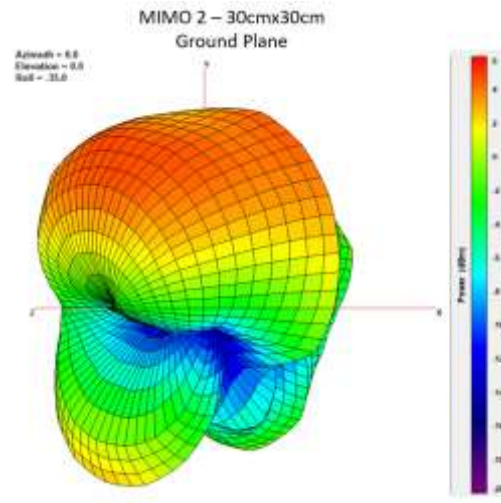
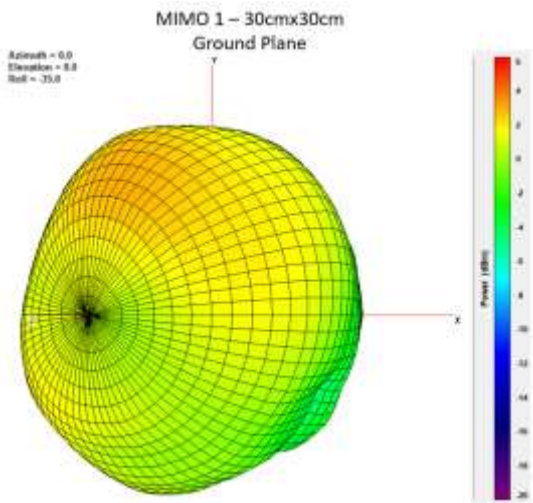

XY Plane

XZ Plane

YZ Plane

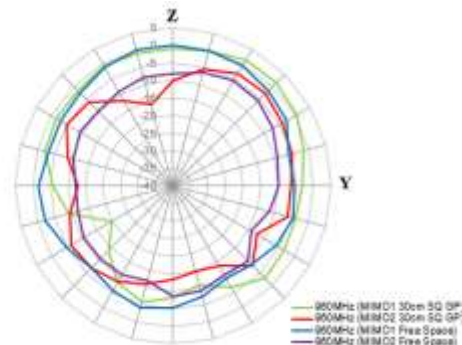
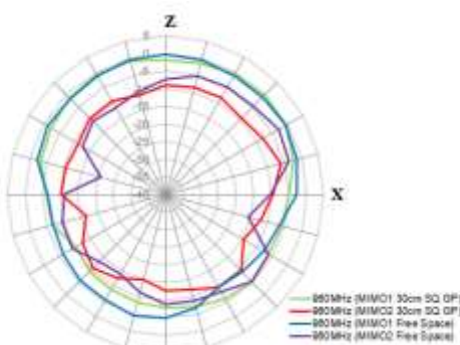
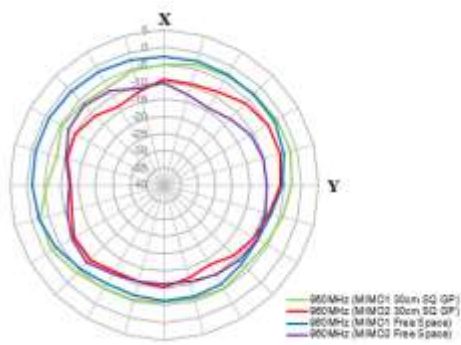

1710MHz

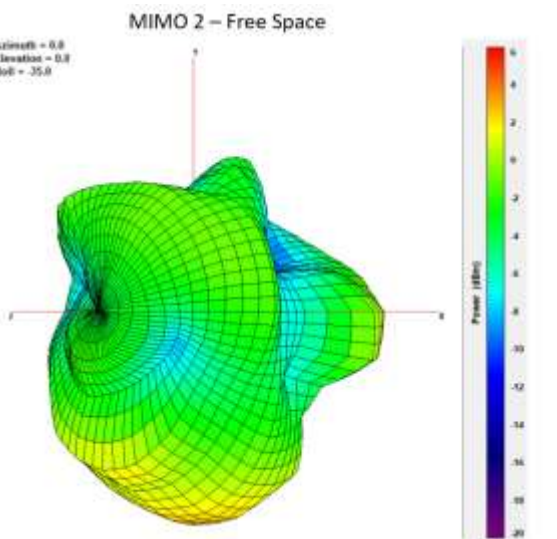
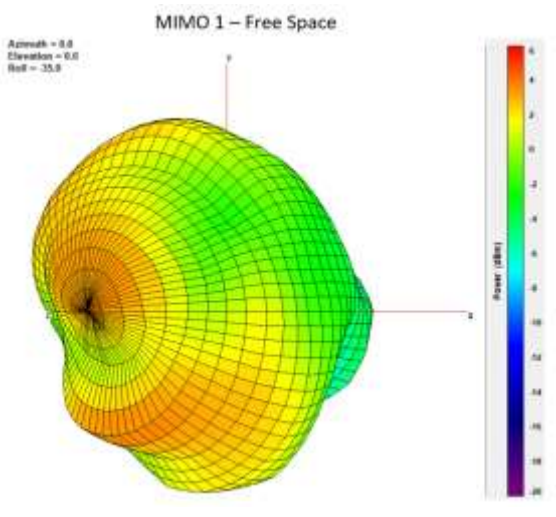
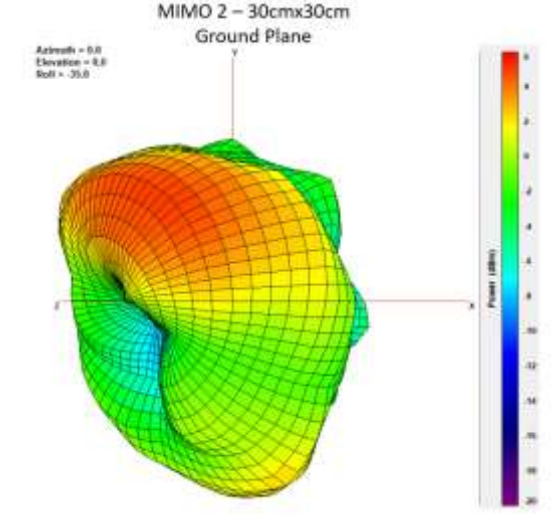
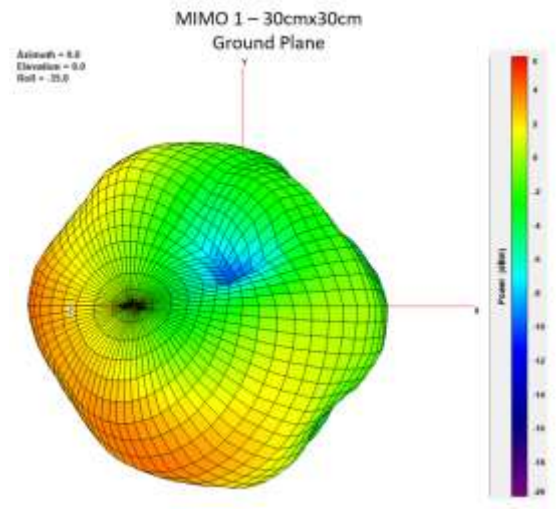

XY Plane

XZ Plane

YZ Plane

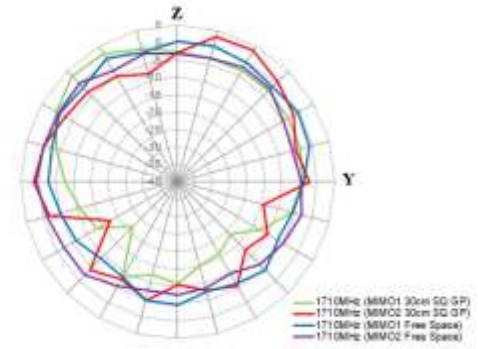
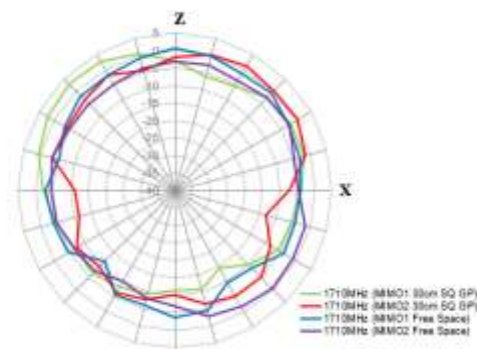
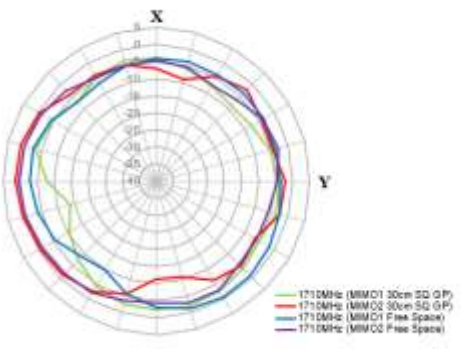

1880MHz

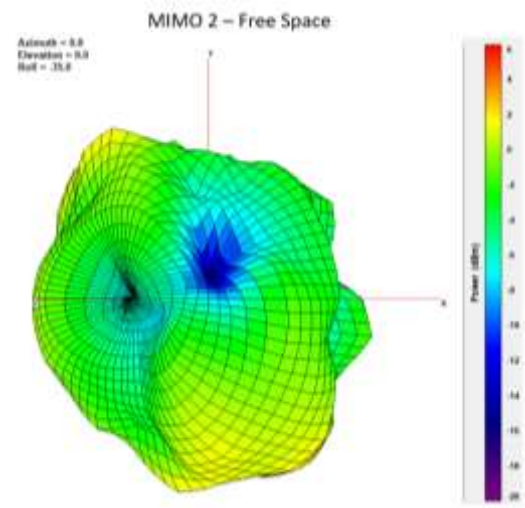
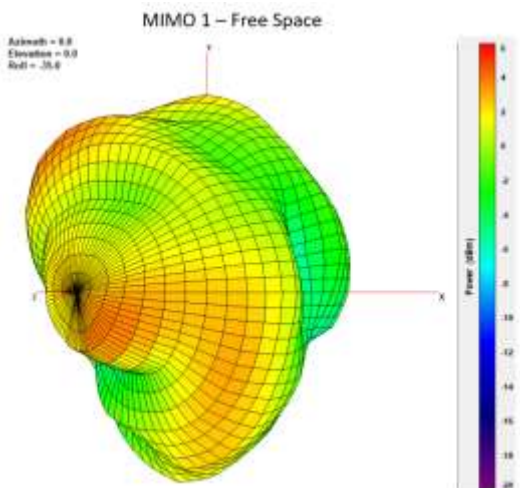
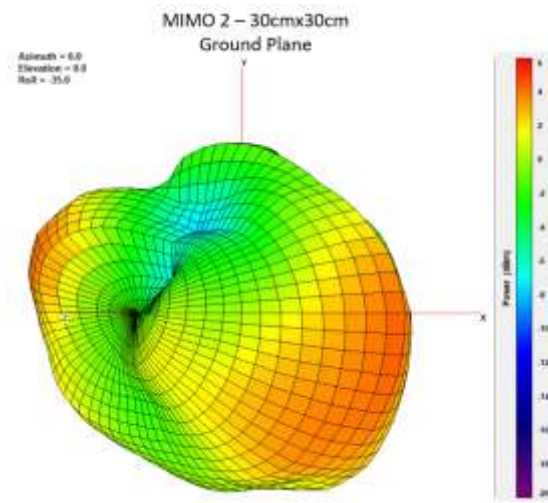
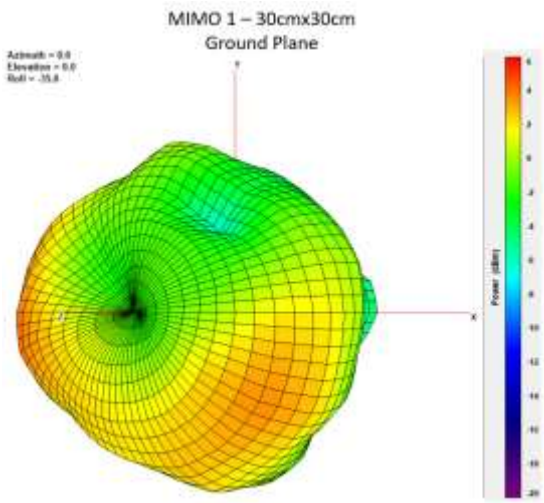

XY Plane

XZ Plane

YZ Plane

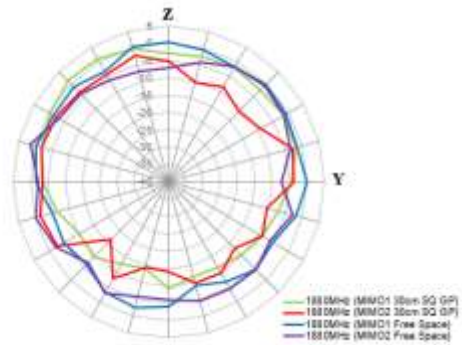
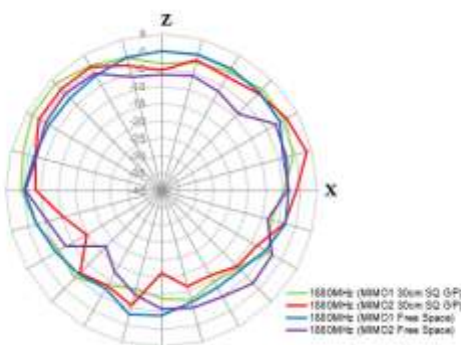
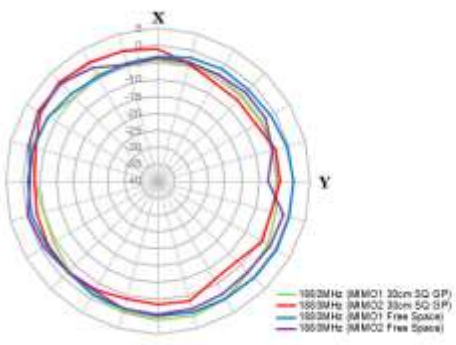

1990MHz

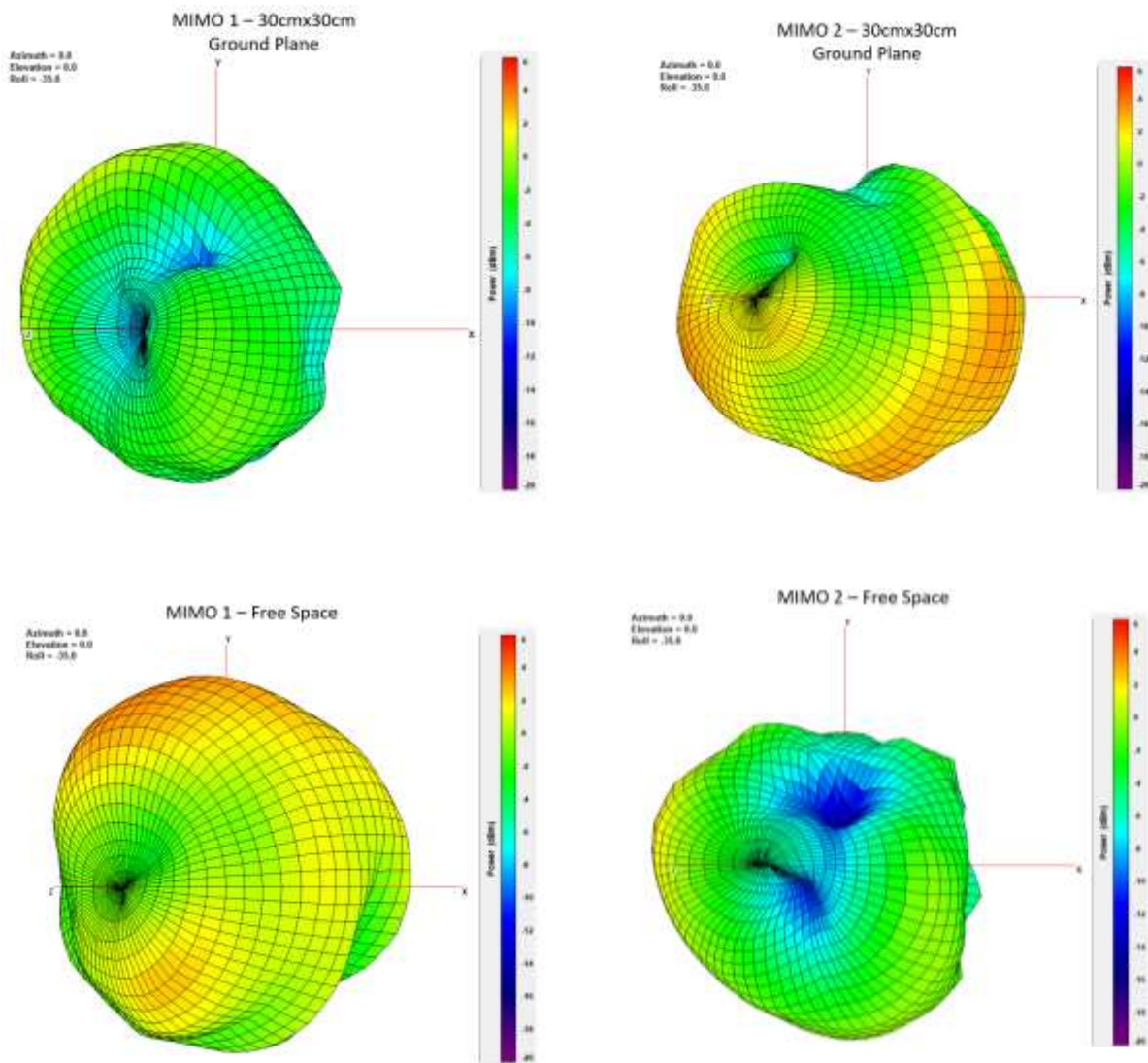

XY Plane

XZ Plane

YZ Plane

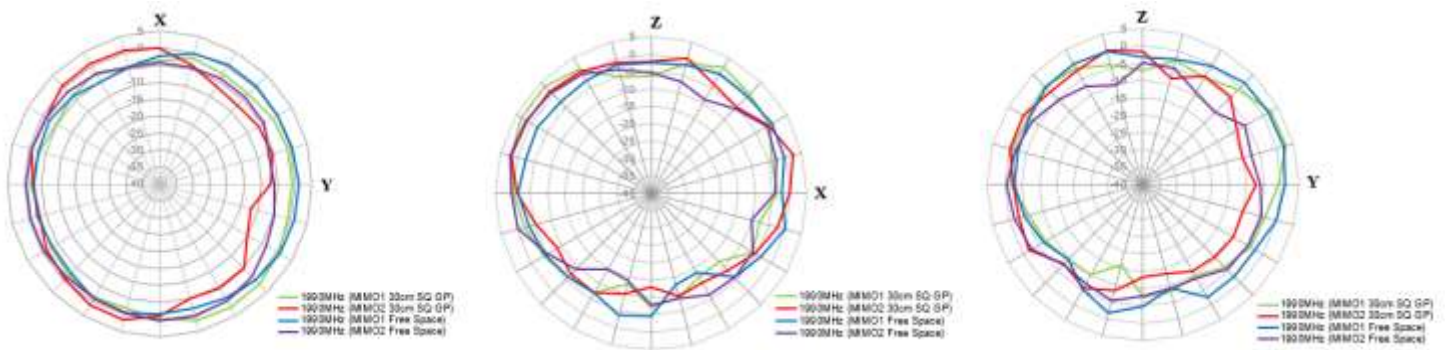

2170MHz

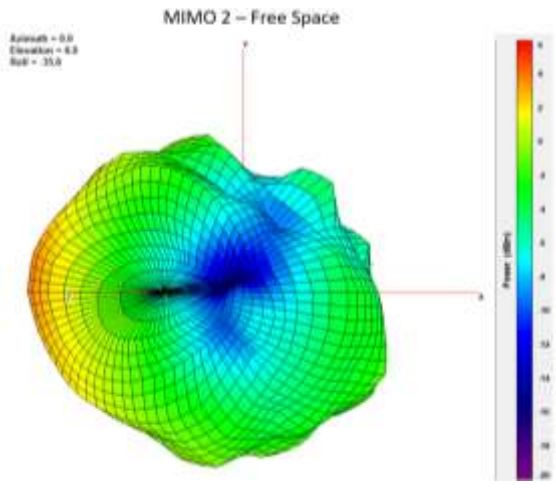
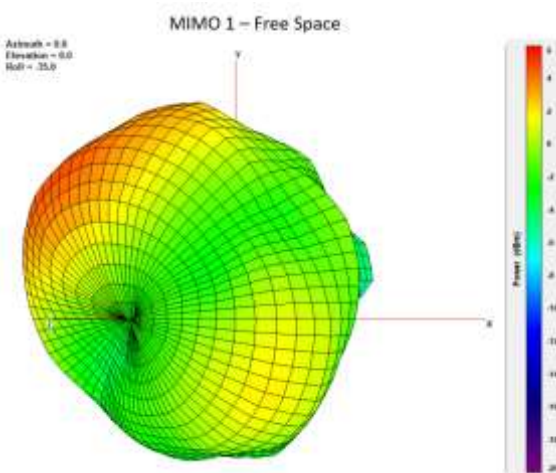
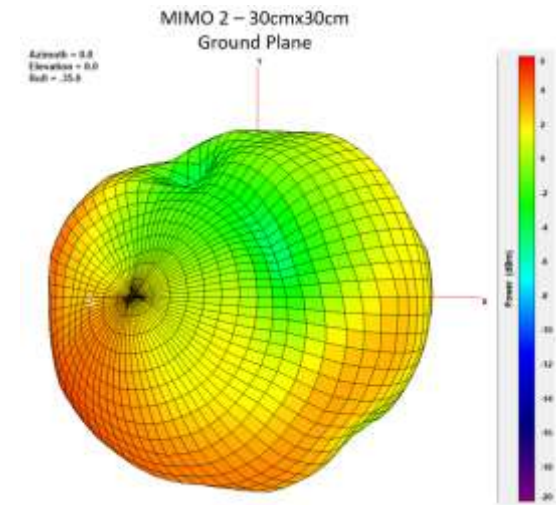
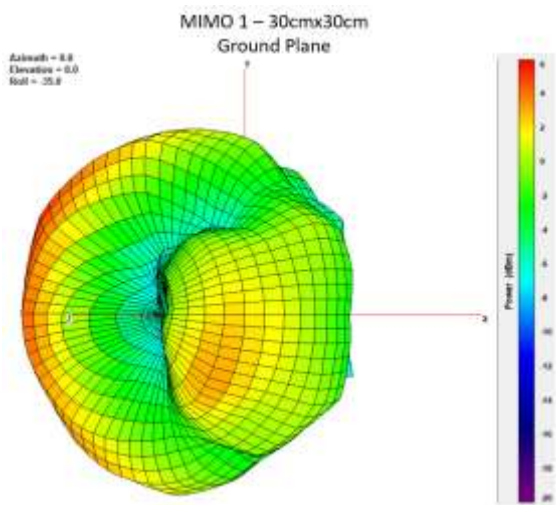

XY Plane

XZ Plane

YZ Plane

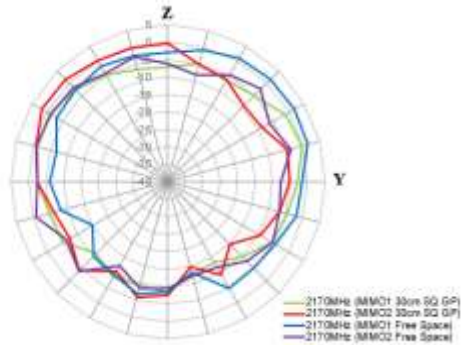
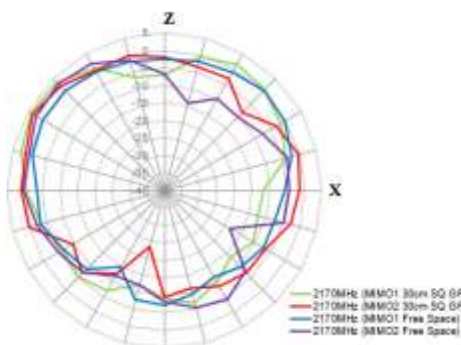
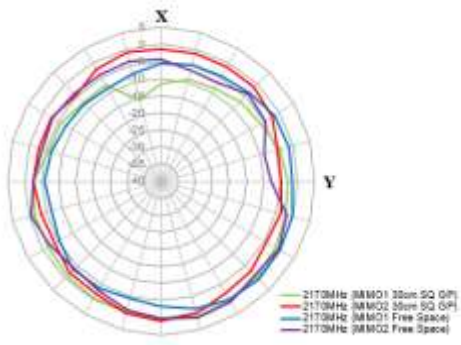

2300MHz

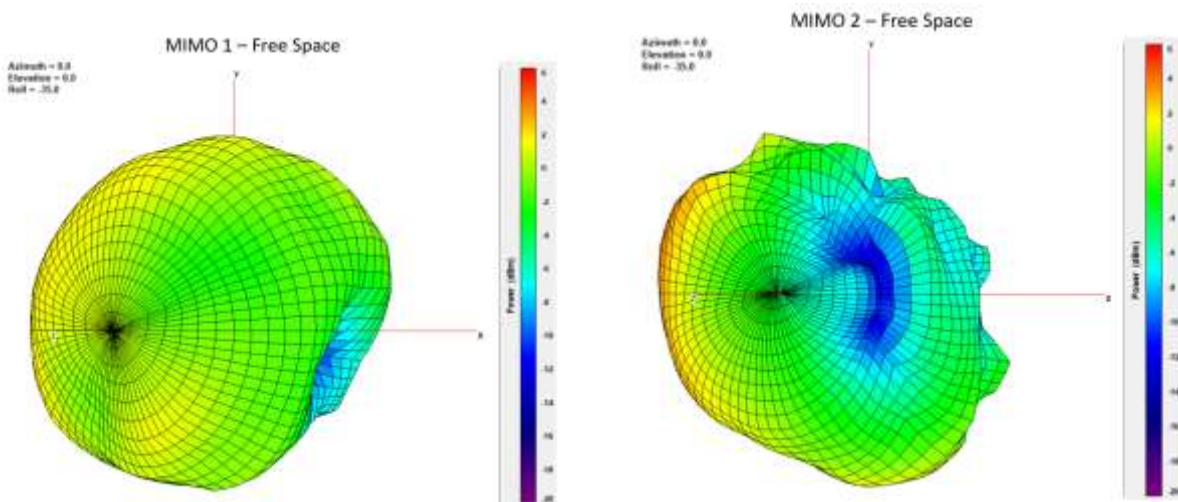
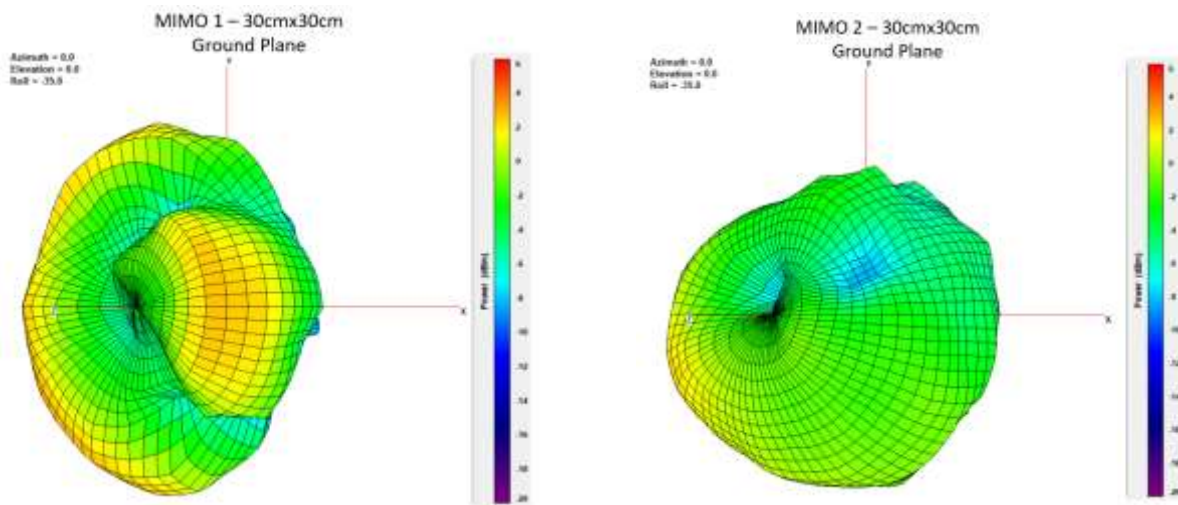

XY Plane
XZ Plane
YZ Plane

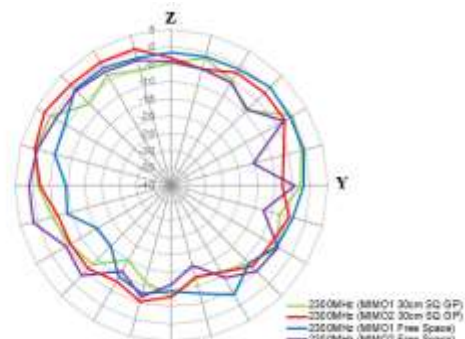
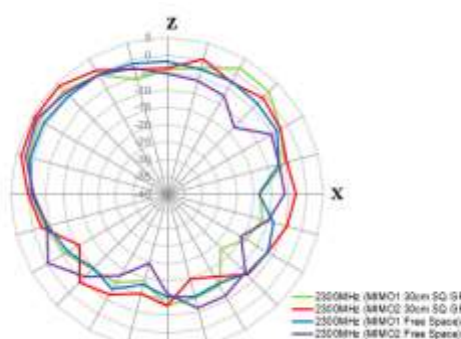
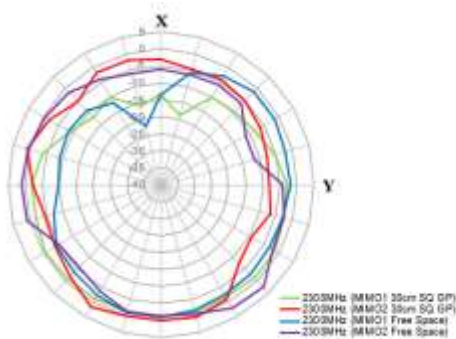

2500MHz

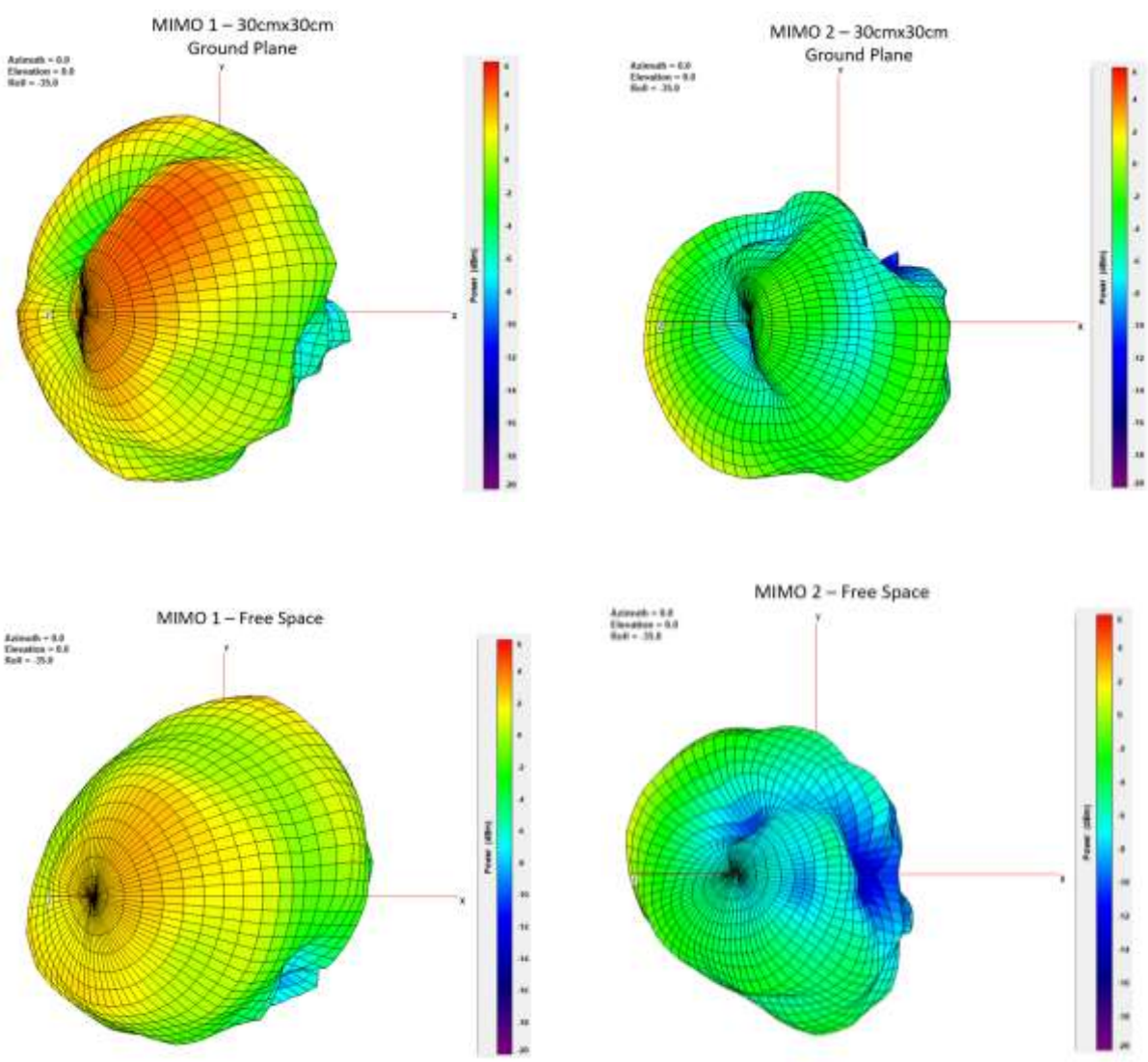

XY Plane

XZ Plane

YZ Plane

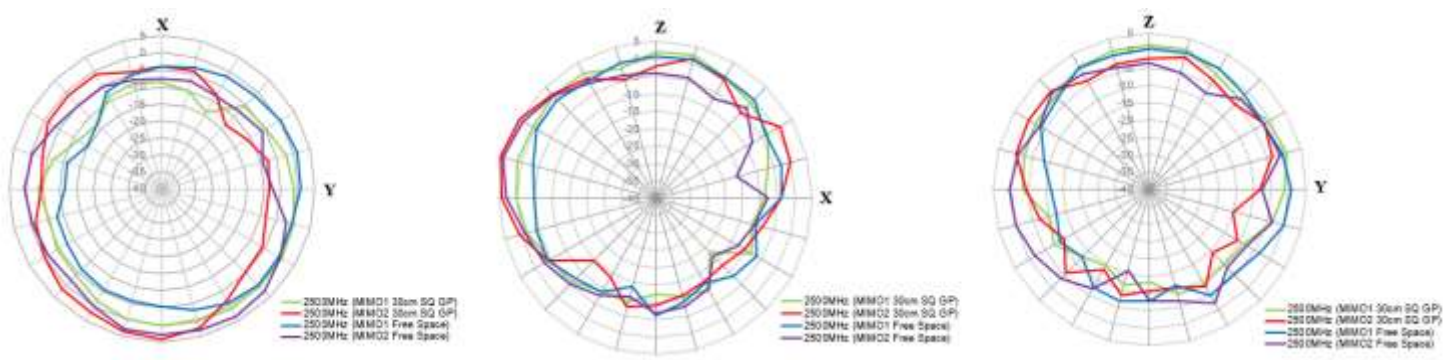

2570MHz

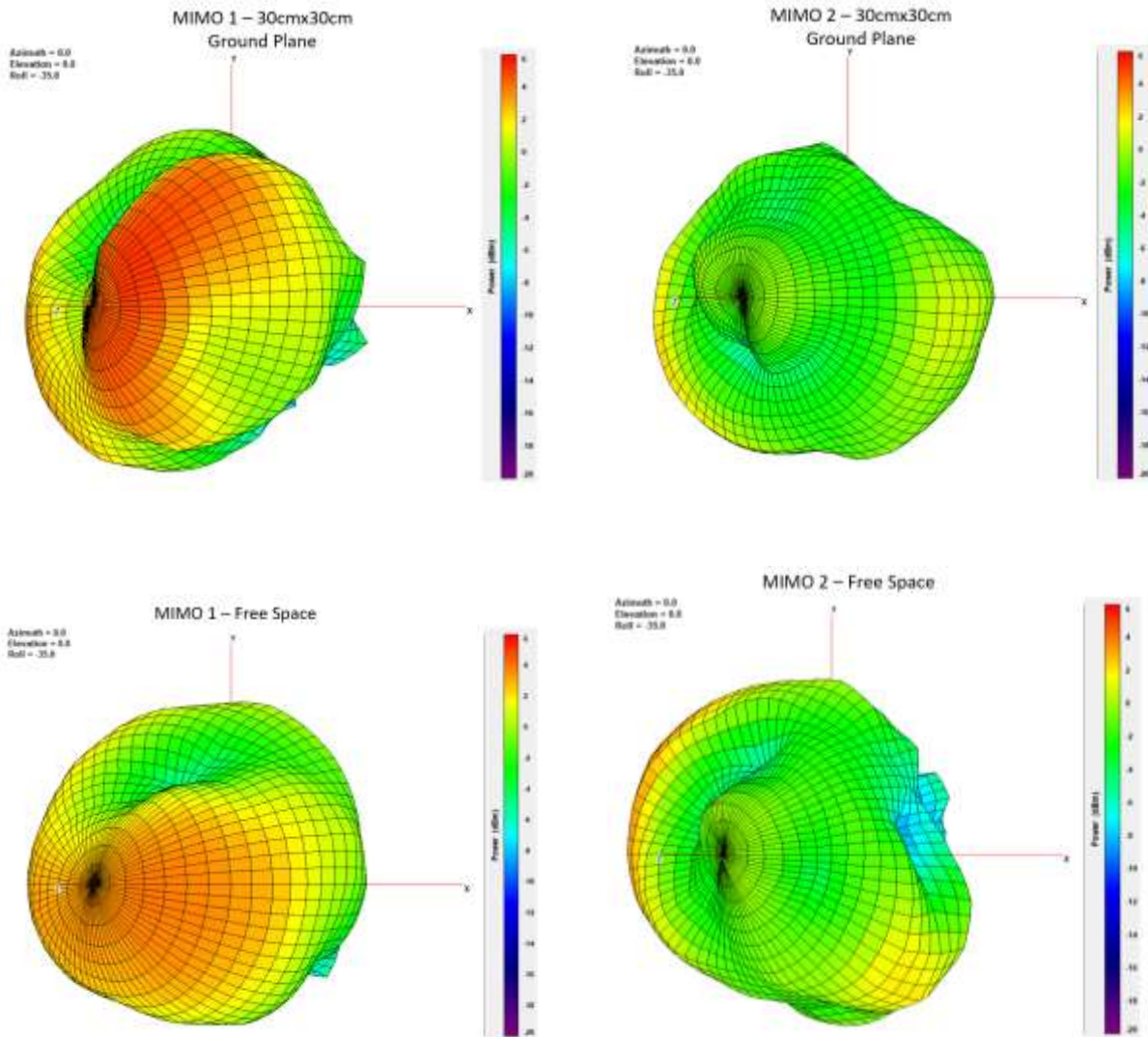

XY Plane
XZ Plane
YZ Plane

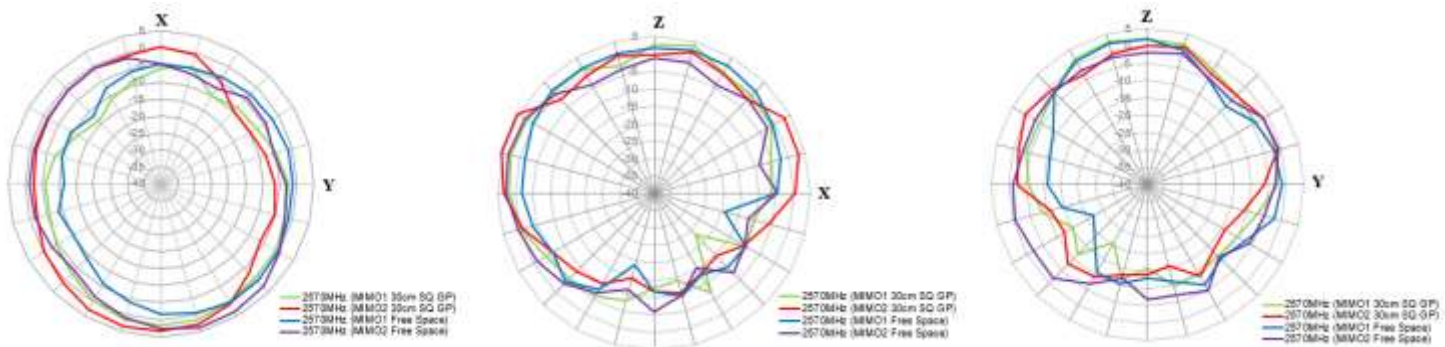

2700MHz

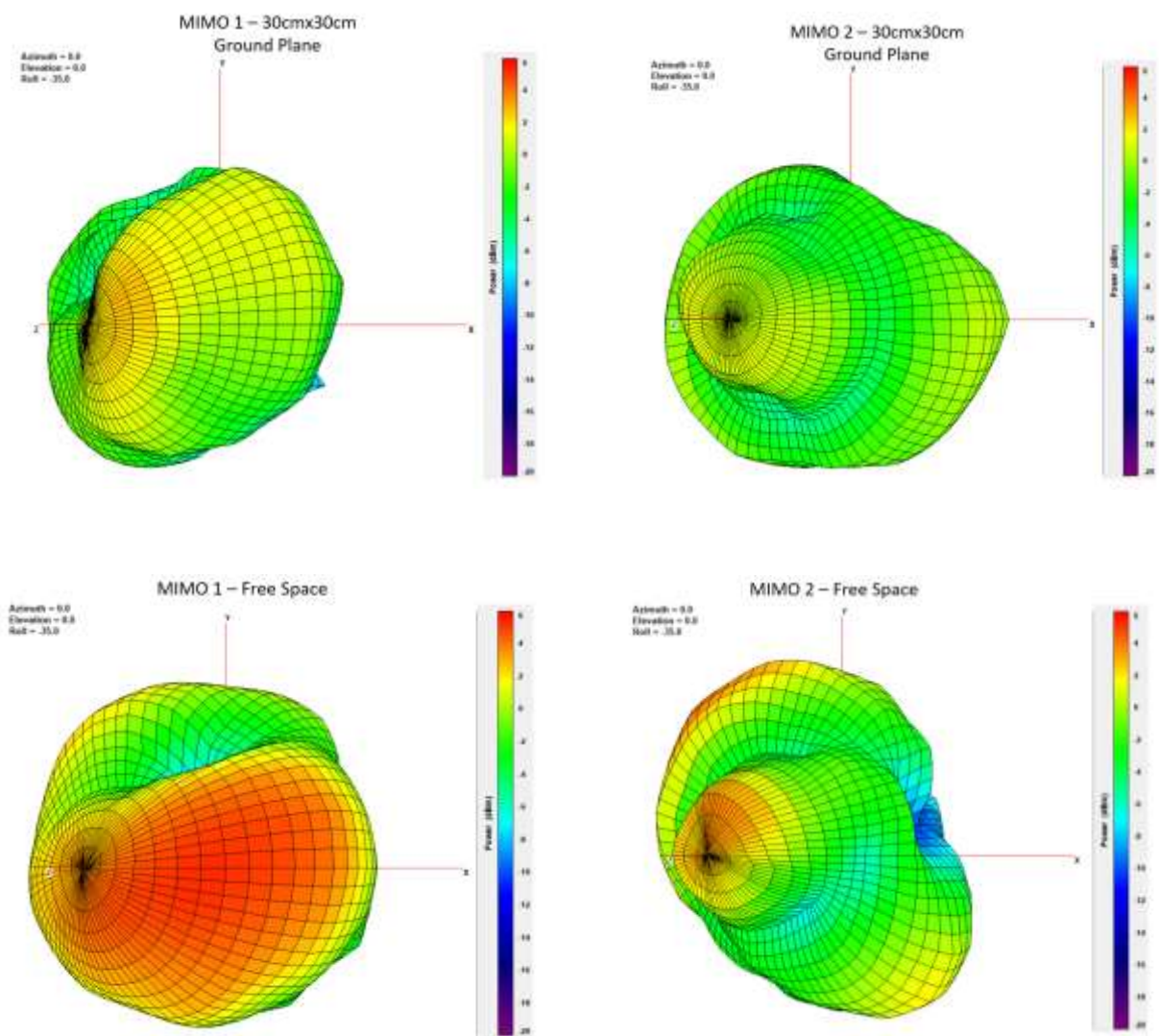

XY Plane
XZ Plane
YZ Plane

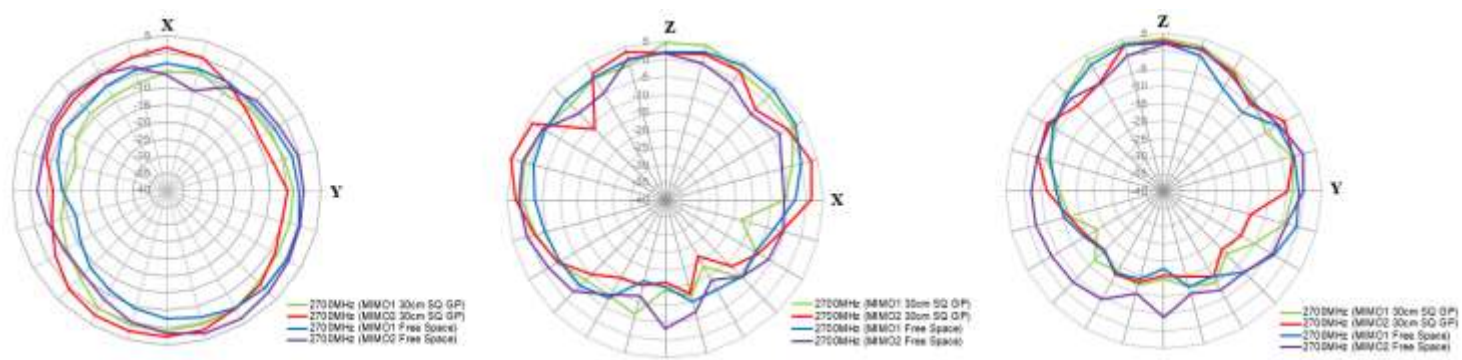

3200MHz

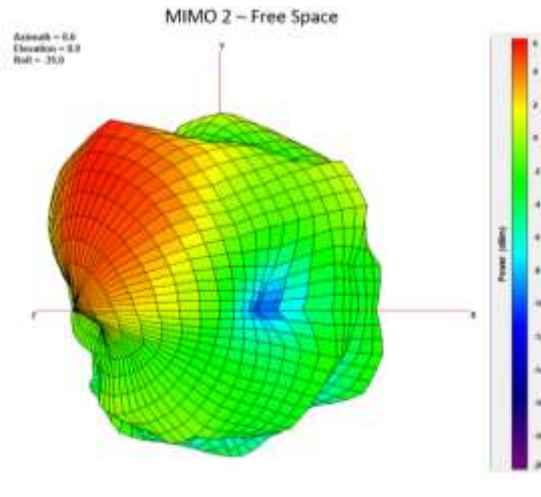
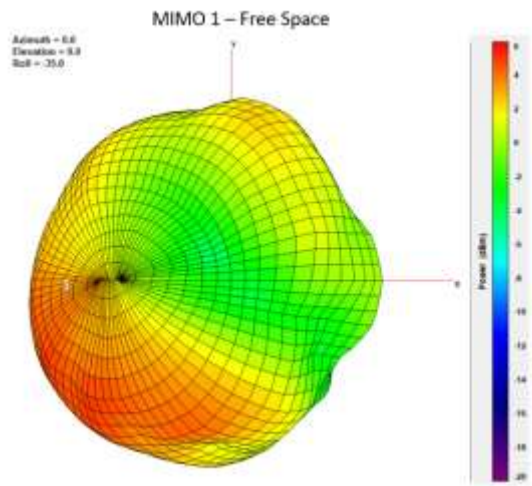
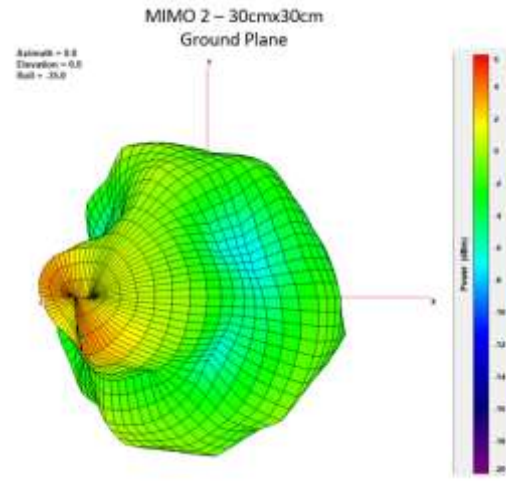
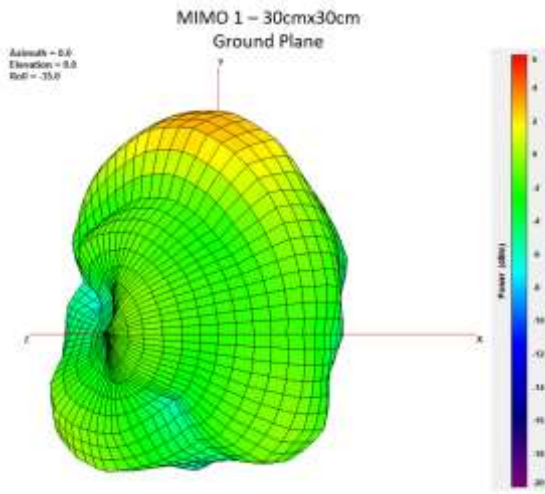

XY Plane

XZ Plane

YZ Plane

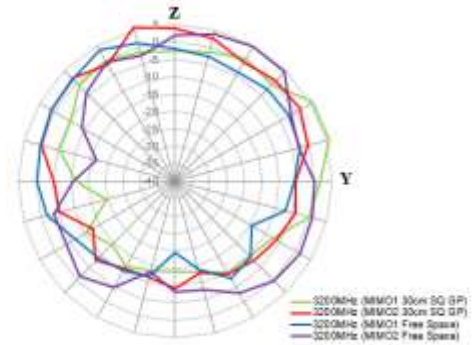
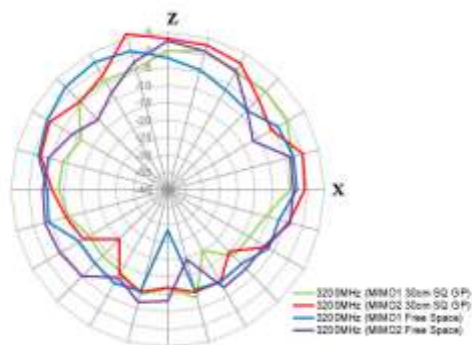
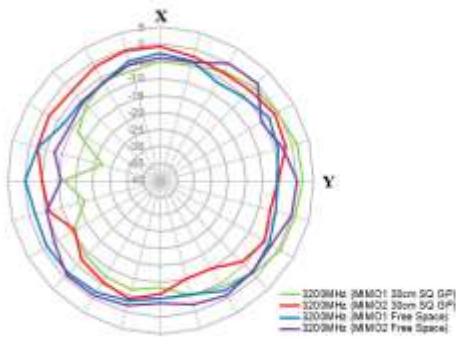

4200MHz

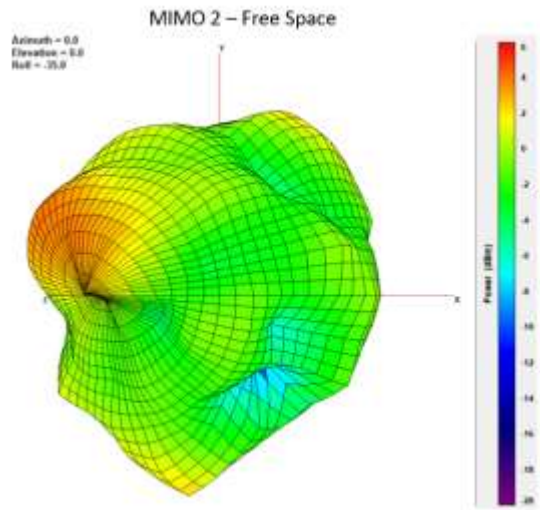
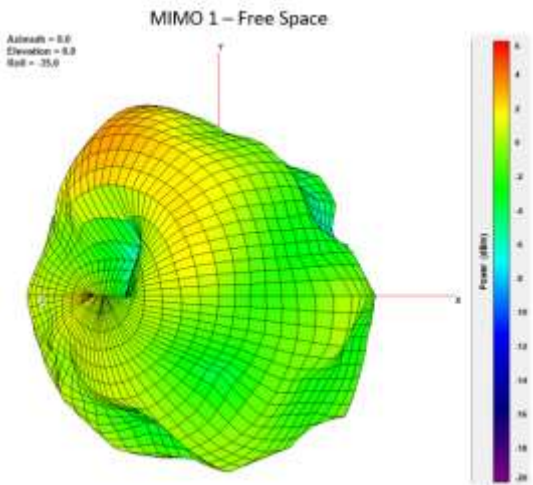
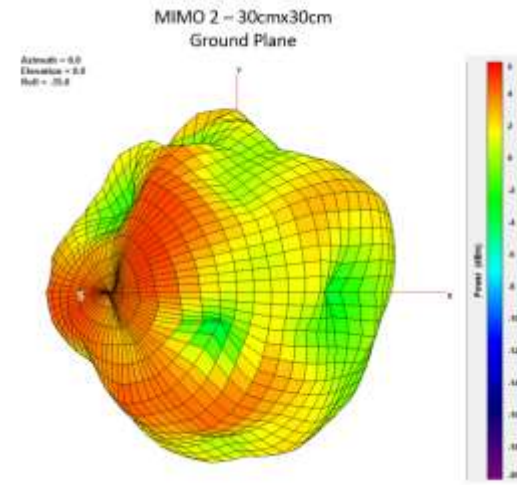
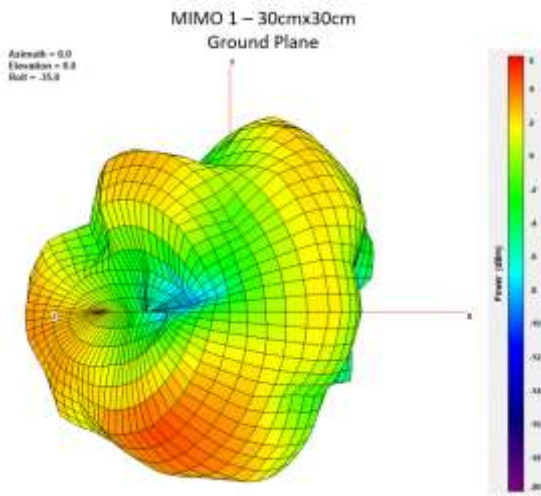

XY Plane

XZ Plane

YZ Plane

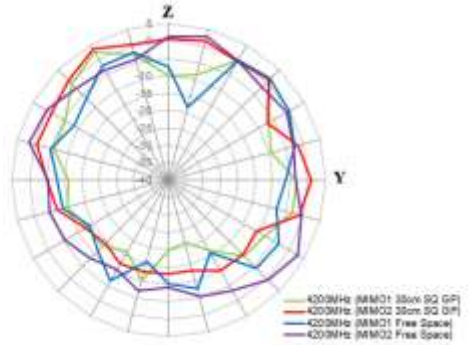
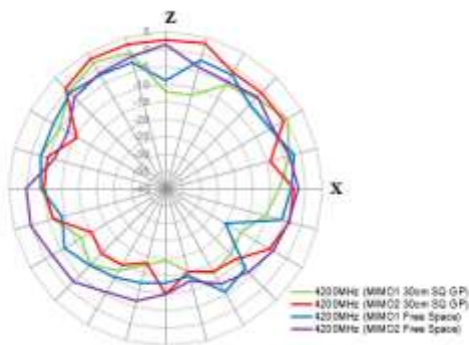
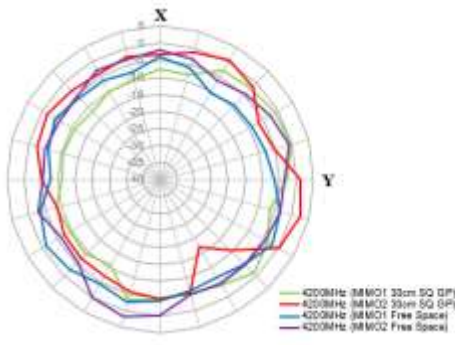

5150MHz

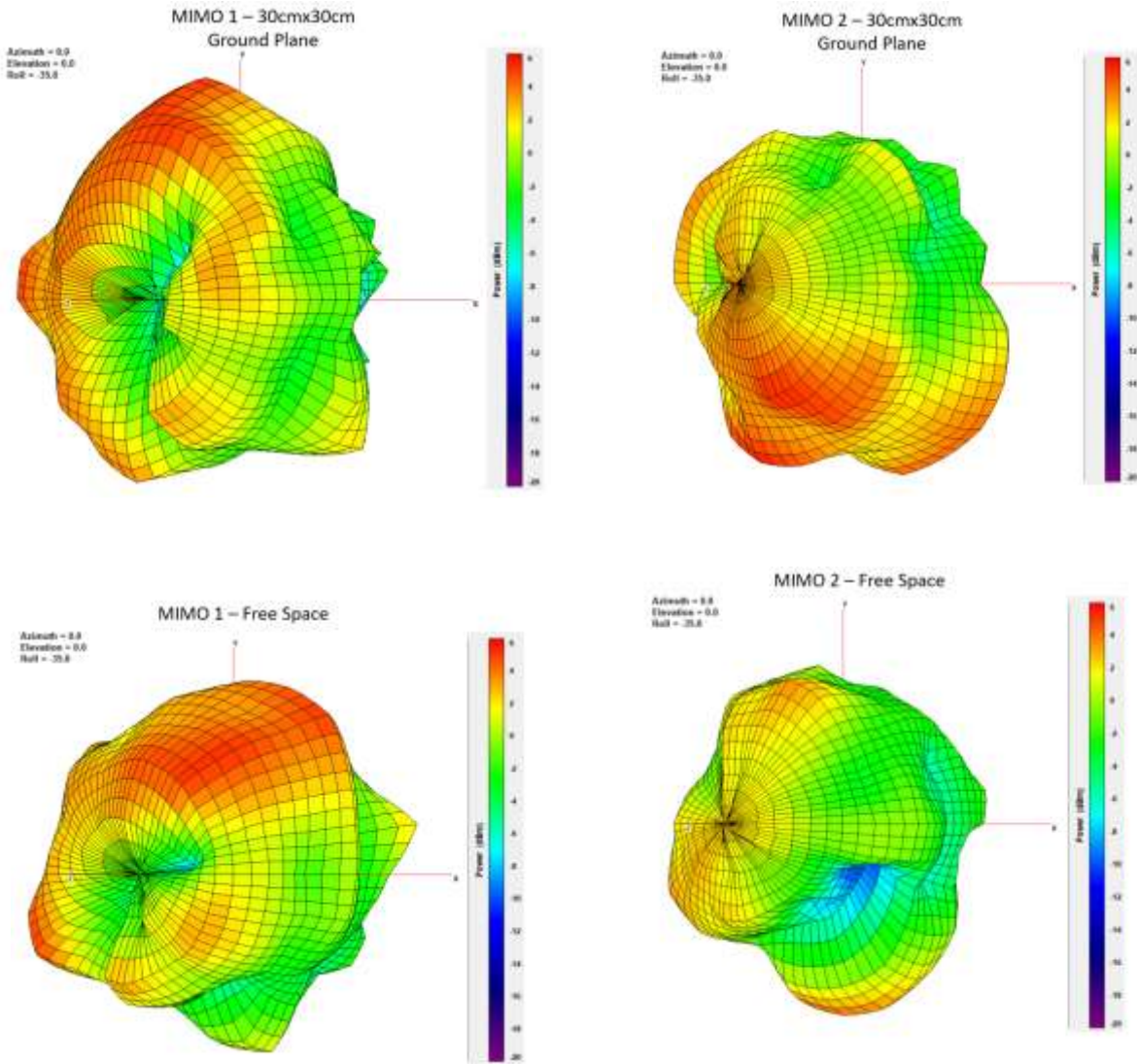

XY Plane

XZ Plane

YZ Plane

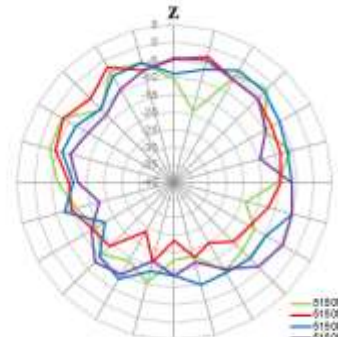
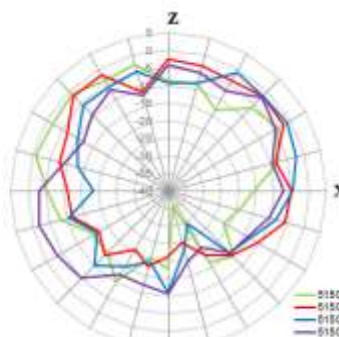
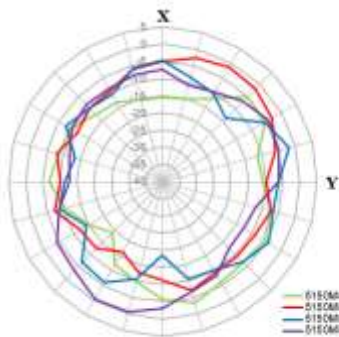

5550MHz

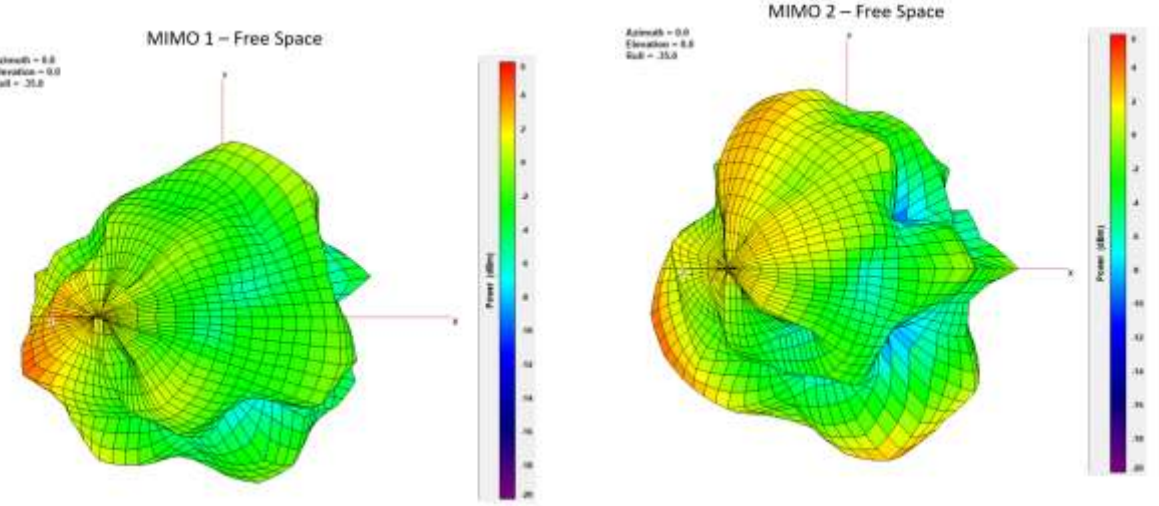
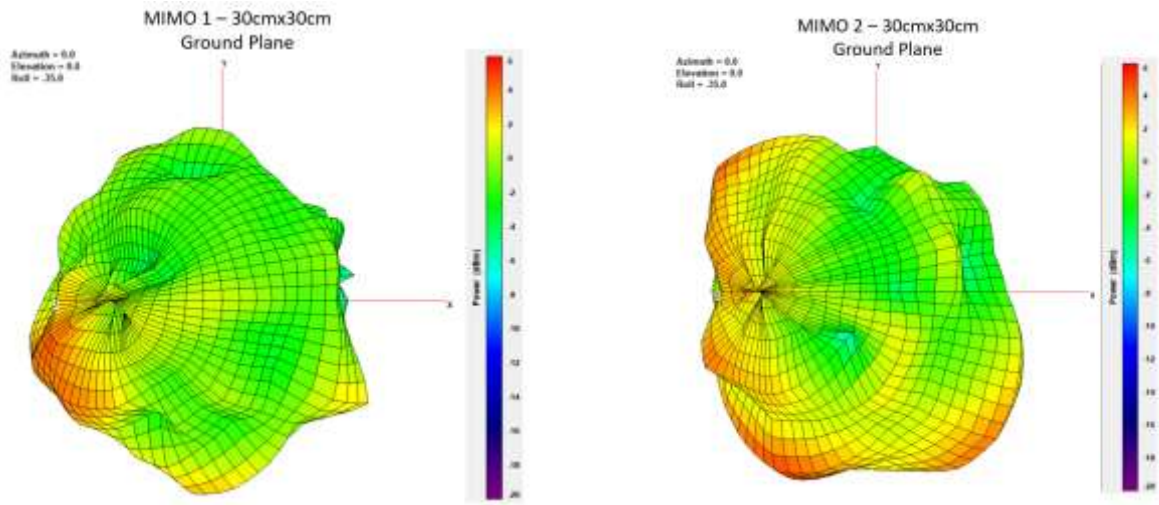

XY Plane

XZ Plane

YZ Plane

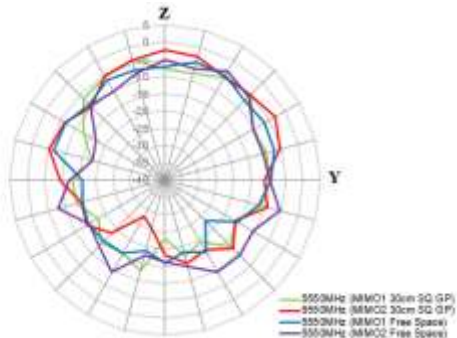
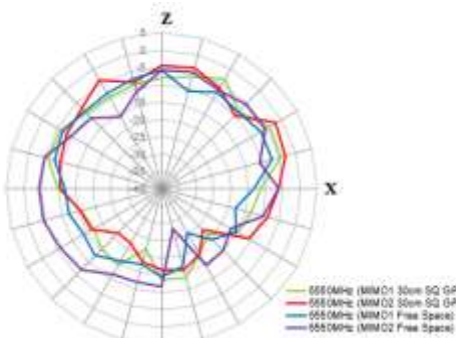
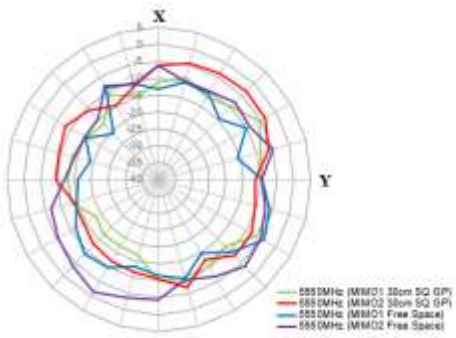

5. Mechanical Drawing

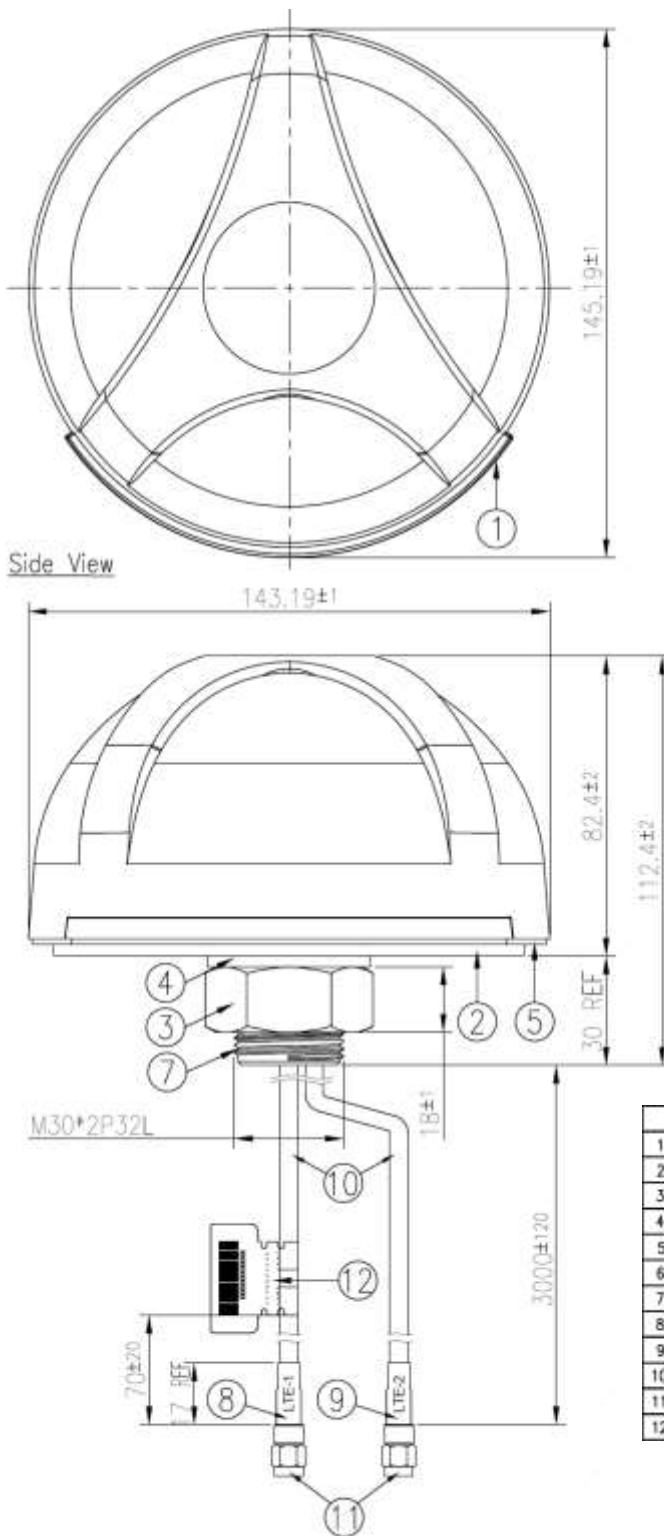

△ Bottom Thread View

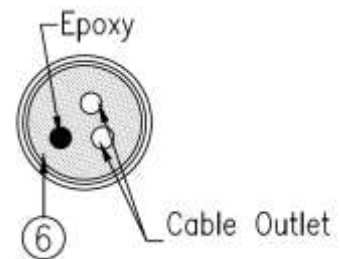

	Name	P/N	Material	Finish	QTY
1	Housing	000111F010015A	ABS+PC/PC540	Black	1
2	Adhesive Foam(Black Foam)	001011F030039A	3M 9448HK+CR4305	White Liner	1
3	M30 Nut	000411F000015A	Steel AISI 1006	Ni Plated	1
4	Washer M30	000411F010015A	Steel AISI 1006	Ni Plated	1
5	Waterproof Gasket	000711F000015A	Silicon Rubber	Black	1
6	Rubber Stopper	000711F010015A	Silicone Rubber	Black	1
7	M30x 2 Thread 32L	000311F000015A	Zinc Alloy	Ni Plated	1
8	Heat Shrink Tube (LTE-1)	001317C020000A	PE	Red Tube/White Text	1
9	Heat Shrink Tube (LTE-2)	001317C030000A	PE	Red Tube/White Text	1
10	CFD200 Coaxial Cable	301415C010000A	PE	Black	2
11	SMA(M)ST	200212G010015A	Brass	Au Plated	2
12	Barcode Label	001013G000015A	PEPA	White	1

6. Installation

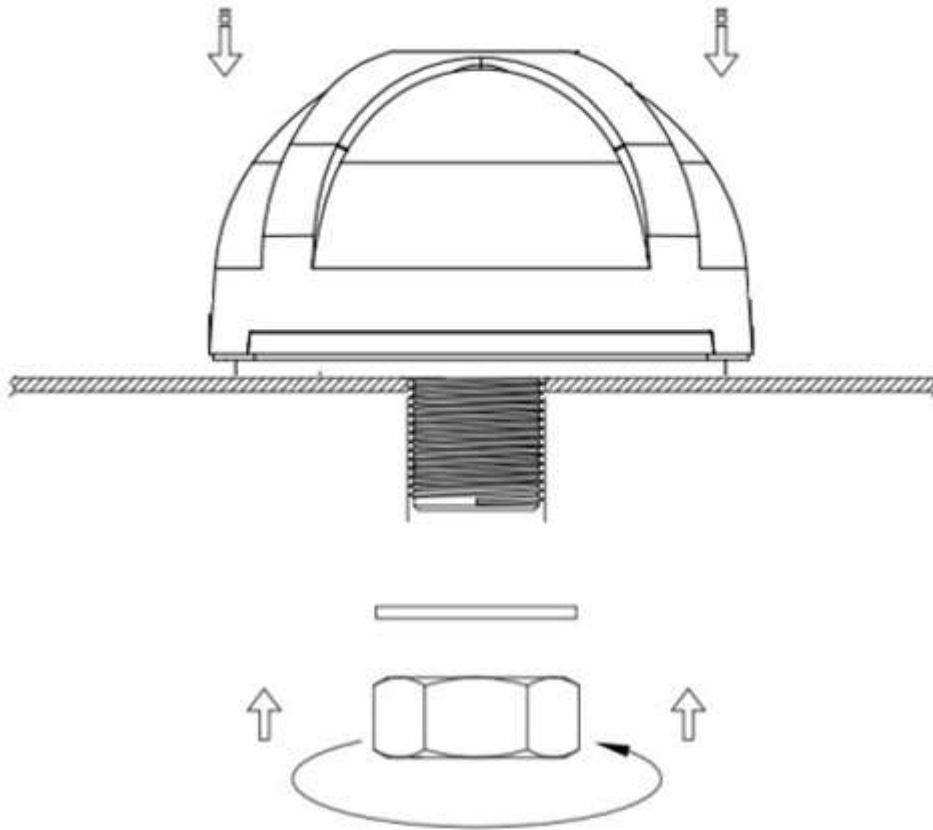

Recommended torque for mounting: 5-7Nm

(Torque value obtained with antenna mounted on 1mm thick SUS-316 bracket)

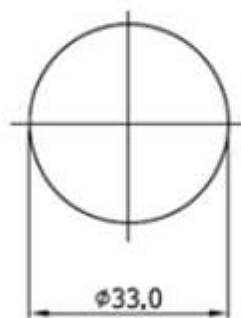

**Recommended
Mounting Hole**

Unit:mm

7. Packaging

MA741.B.BI.001

Packaging Specifications

1 MA741.B.BI.001 per box
 Box Dimensions - 185*170*180 mm
 Total Weight - 1.26Kg

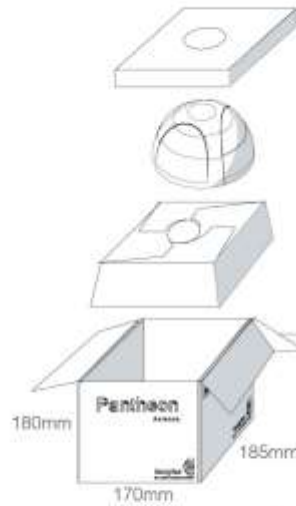

8 boxes per carton
 Carton Dimensions - 380*350*380mm
 Total Weight - 11Kg

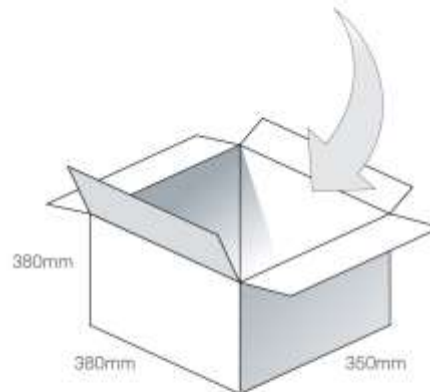

Pallet Dimensions 1100*1100*1290mm
 24 Cartons per pallet
 6 Cartons per layer
 4 Layers

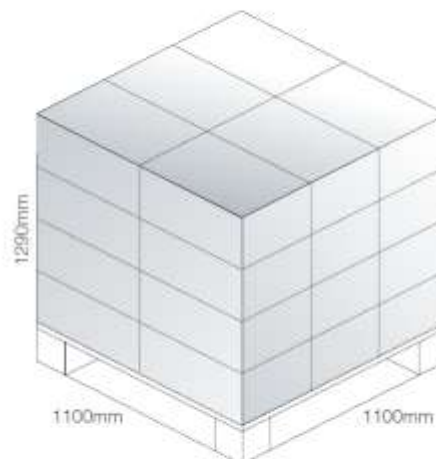

Changelog for the datasheet

SPE-15-8-032– MA741.B.BI.001

Revision: E (Current Version)

Date:	2022-06-02
Changes:	Full datasheet update.
Changes Made by:	Cesar Sousa

Previous Revisions

Revision: D

Date:	2021-05-04
Changes:	Updated Specifications
Changes Made by:	Gary West

Revision: C

Date:	2017-04-04
Changes:	Added LTE Band Table
Changes Made by:	Peter Monahan

Revision: B

Date:	2016-01-02
Changes:	updated packaging
Changes Made by:	Aine Doyle

Revision: A (Original First Release)

Date:	2015-09-08
Notes:	
Author:	Technical Writer



TAOGLAS®

www.taoglas.com



Mouser Electronics

Authorized Distributor

Click to View Pricing, Inventory, Delivery & Lifecycle Information:

[Taoglas:](#)

[MA741.B.BI.001](#)