



# TAOGLAS®



# Datasheet

**Part No:**  
*MA343.W.LBI.001*

**Description**

3-in-1 White Magnet Mount GNSS and 2x 4G LTE MIMO  
With 2m of RG-174 Cable and SMA(M) Connectors

**Features:**

Low-profile Magnetic Mount Antenna  
2\* 4G/LTE MIMO covering 600-6000MHz  
1\* GPS-GLONASS  
Dims: 58mm \* 58mm \* 65mm  
Cable: 2m of RG174  
Connector: SMA(M)  
RoHS & Reach Compliant

|           |                                |           |
|-----------|--------------------------------|-----------|
| <b>1.</b> | <b>Introduction</b>            | <b>3</b>  |
| <b>2.</b> | <b>Specification</b>           | <b>4</b>  |
| <b>3.</b> | <b>Mechanical Drawing</b>      | <b>7</b>  |
| <b>4.</b> | <b>Packaging</b>               | <b>8</b>  |
| <b>5.</b> | <b>Antenna Characteristics</b> | <b>9</b>  |
| <b>6.</b> | <b>LNA Characteristics</b>     | <b>15</b> |
| <b>7.</b> | <b>Radiation Patterns</b>      | <b>18</b> |
| <hr/>     |                                |           |
|           | Changelog                      | 48        |

Taoglas makes no warranties based on the accuracy or completeness of the contents of this document and reserves the right to make changes to specifications and product descriptions at any time without notice. Taoglas reserves all rights to this document and the information contained herein. Reproduction, use or disclosure to third parties without express permission is strictly prohibited.

Ireland & USA  
ISO 9001:2015  
Certified



Taiwan  
ISO 9001:2015  
Certified



# 1. Introduction



The Taoglas MA343 magnetic mount antenna is a high performance 3-in-1 combination antenna with GNSS and 2x 5G/4G MIMO. The robust, compact housing is just at only 65mm tall and 58mm in diameter, it is an ideal for external antenna for assets requiring GNSS, Cellular and Wi-Fi connectivity.

The GPS/GLONASS/Galileo antenna has stable gain and radiation patterns on all bands. The 5G/4G antenna, covers all worldwide LTE bands, includes many sub 6GHz, 5G FR1 bands and includes fallback to 3G/2G bands where required.

The IP67 rated enclosure is made from a durable, UV resistant ASA material that makes it resistant to vandalism or impact. An integrated rubber O-ring under the enclosure prevents water ingress under the antenna. It is mounted from the inside of the user device enclosure and the small thread allows for installation in situations where space is minimal.

Typical applications include:

- Smart Metering and Remote Monitoring
- Digital Signage
- Transportation and Telematics

Cable type and length, and connectors are fully customizable, and the MA343 can also be customized for other configurations. It is also available in black (MA343.A.LBI.001). Contact your regional Taoglas customer support team for more information.

## 2. Specification

| GNSS Frequency Bands |                         |                           |                    |                    |                   |
|----------------------|-------------------------|---------------------------|--------------------|--------------------|-------------------|
| GPS                  | L1<br>1575.42 MHz       | L2<br>1227.6 MHz          | L5<br>1176.45 MHz  |                    |                   |
|                      | ■                       | □                         | □                  |                    |                   |
| GLONASS              | G1<br>1602 MHz          | G2<br>1248 MHz            | G3<br>1207 MHz     |                    |                   |
|                      | ■                       | □                         | □                  |                    |                   |
| Galileo              | E1<br>1575.24 MHz       | E5a<br>1176.45 MHz        | E5b<br>1201.5 MHz  | E6<br>1278.75 MHz  |                   |
|                      | ■                       | □                         | □                  | □                  |                   |
| BeiDou               | B1C<br>1575.42 MHz      | B1I<br>1561 MHz           | B2a<br>1176.45 MHz | B2b<br>1207.14 MHz | B3<br>1268.52 MHz |
|                      | ■                       | ■                         | □                  | □                  | □                 |
| L-Band               | L-Band<br>1542 MHz      |                           |                    |                    |                   |
|                      | □                       |                           |                    |                    |                   |
| QZSS (Regional)      | L1<br>1575.42 MHz       | L2C<br>1227.6 MHz         | L5<br>1176.45 MHz  | L6<br>1278.75e6    |                   |
|                      | ■                       | □                         | □                  | □                  |                   |
| IRNSS (Regional)     | L5<br>1176.45 MHz       |                           |                    |                    |                   |
|                      | □                       |                           |                    |                    |                   |
| SBAS                 | L1/E1/B1<br>1575.42 MHz | L5/B2a/E5a<br>1176.45 MHz | G1<br>1602 MHz     | G2<br>1248 MHz     | G3<br>1207 MHz    |
|                      | ■                       | □                         | ■                  | □                  | □                 |

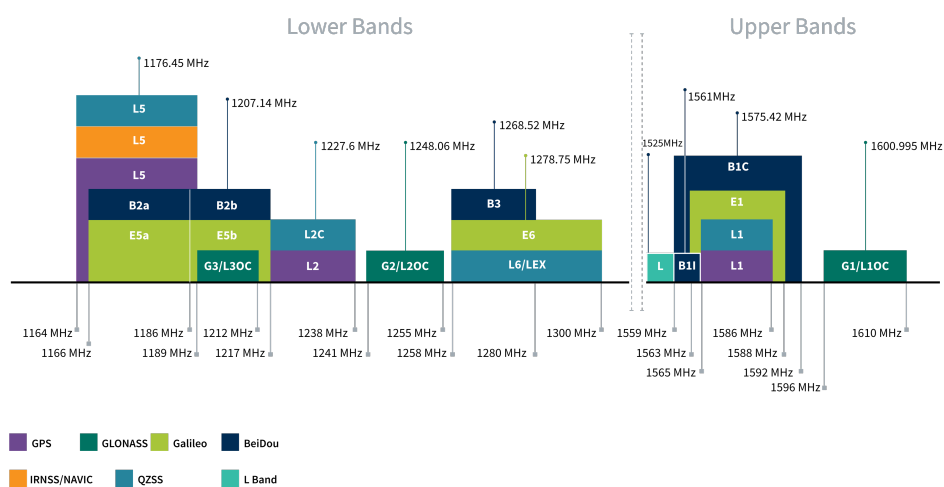

GNSS Bands and Constellations



| GNSS Electrical                |       |         |       |
|--------------------------------|-------|---------|-------|
| Frequency (MHz)                | 1561  | 1575.42 | 1603  |
| VSWR (max.)                    | 3:1   | 3:1     | 3:1   |
| Passive Antenna Efficiency (%) | 28.22 | 36.12   | 45.39 |
| Passive Antenna Gain (dBi)     | -3.73 | -1.2    | -1.2  |
| Polarization                   | RHCP  |         |       |
| Impedance                      | 50 Ω  |         |       |

| LNA and Filter Electrical Properties |  |         |      |
|--------------------------------------|--|---------|------|
| Frequency (MHz)                      | 1561                                   | 1575.42 | 1603 |
| Gain (dB)                            | 31.7                                   | 31.2    | 29.8 |
| Noise (dB)                           | 2.29                                   | 2.15    | 2.5  |
| Voltage Range                        | 1.8-5.5V                               |         |      |
| Current Consumption                  | 9 ± 3                                  |         |      |
| Out-off-band rejection (dB)          | > 70 @700-960MHz , > 60 @ 1710-6000MHz |         |      |

| LTE Electrical                             |                 |             |                |                   |                 |           |              |                   |                  |
|--|-----------------|-------------|----------------|-------------------|-----------------|-----------|--------------|-------------------|------------------|
| Band                                       | Frequency (MHz) | Measurement | Efficiency (%) | Average Gain (dB) | Peak Gain (dBi) | Impedance | Polarization | Radiation Pattern | Max. input power |
| 5GNR/4G Band71                             | 617-698         | LTE1        | 28.1           | -5.51             | -0.78           | 50 Ω      | Linear       | Omni              | 2W               |
|  |                 | LTE2        | 24.7           | -6.07             | -0.91           |           |              |                   |                  |
| 4G/3G Band 12,13,14,17,28,29               | 698-824         | LTE1        | 44.7           | -3.50             | 0.99            |           |              |                   |                  |
|  |                 | LTE2        | 43.3           | -3.63             | 1.12            |           |              |                   |                  |
| 4G/3G/NB-IoT/Cat M Band 5,8,18,19,20,26,27 | 824-960         | LTE1        | 46.7           | -3.31             | 0.99            |           |              |                   |                  |
|  |                 | LTE2        | 57.4           | -2.41             | 1.55            |           |              |                   |                  |
| 5GNR/4G Band 21,32,74,75,76                | 1427-1518       | LTE1        | 33.2           | -4.79             | 2.87            |           |              |                   |                  |
|  |                 | LTE2        | 30.6           | -5.15             | 2.68            |           |              |                   |                  |
| 4G/3G Band 1,2,3,4,9,23,25,35,39,66        | 1710-2200       | LTE1        | 65.3           | -1.85             | 5.93            |           |              |                   |                  |
|  |                 | LTE2        | 63.5           | -1.97             | 5.34            |           |              |                   |                  |
| 4G/3G Band 7,30,38,40,41                   | 2300-2690       | LTE1        | 69.0           | -1.61             | 5.64            |           |              |                   |                  |
|  |                 | LTE2        | 70.9           | -1.50             | 5.95            |           |              |                   |                  |
| 5GNR/4G Band 22,42,48,77,78,79             | 3300-5000       | LTE1        | 55.7           | -2.54             | 6.84            |           |              |                   |                  |
|  |                 | LTE2        | 61.6           | -2.10             | 6.70            |           |              |                   |                  |
| LTE5200/Wi-Fi5800                          | 5150-5925       | LTE1        | 57.3           | -2.42             | 6.00            |           |              |                   |                  |
|  |                 | LTE2        | 56.4           | -2.48             | 5.97            |           |              |                   |                  |

### Mechanical

|                   |                |
|-------------------|----------------|
| <b>Dimensions</b> | 58 x 58 x 65mm |
| <b>Material</b>   | ASA            |
| <b>Connector</b>  | SMA(M)         |
| <b>Cable</b>      | 2m of RG174    |

### Environmental

|                                   |             |
|-----------------------------------|-------------|
| <b>Temperature Range</b>          | -40 - +85°C |
| <b>RoHs &amp; REACH Compliant</b> | Yes         |

### 3. Mechanical Drawing

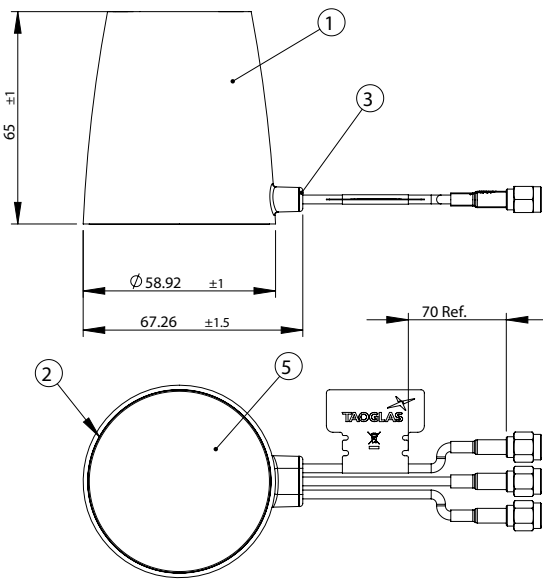
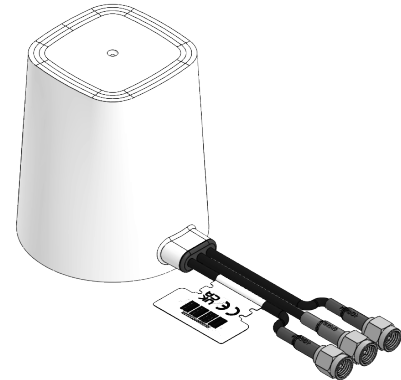
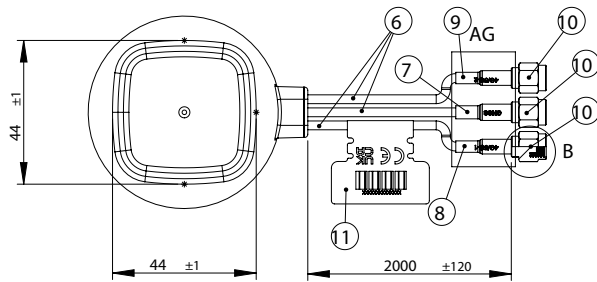

DETAIL AG  
SCALE 1 : 1

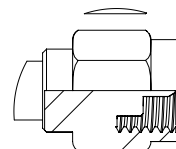

DETAIL B  
SCALE 2 : 1

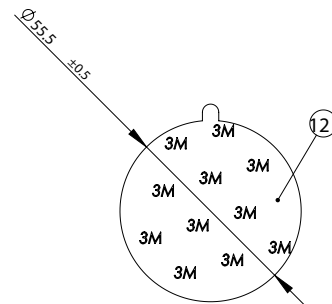

Accessory

|    | Name                             | Material        | Finish               | Qty |
|----|----------------------------------|-----------------|----------------------|-----|
| 1  | Top housing                      | ASA             | White                | 1   |
| 2  | Bottom housing                   | ASA             | Black                | 1   |
| 3  | Grommet                          | Silicone Rubber | Black                | 1   |
| 4  | Magnet pack/N48                  | NdFeB           | Ni Plated            | 1   |
| 5  | Matte Silver Label               | PET             | Matte Silver         | 1   |
| 6  | RG174 Coaxial Cable              | PVC             | Black                | 3   |
| 7  | Heat Shrink Tube(GNSS)           | PE              | Blue Tube/White Text | 1   |
| 8  | Heat Shrink Tube(4G/5G-1)        | PE              | Red Tube/White Text  | 1   |
| 9  | Heat Shrink Tube(4G/5G-2)        | PE              | Red Tube/White Text  | 1   |
| 10 | SMA/MST Plug for RG-316/RG-174   | Brass           | Au Plated            | 3   |
| 11 | CE,WEEE and UKCA mark logo Label | PEPA            | White                | 1   |
| 12 | Double Sided Adhesive            | 3M VHB 5952     | Black foam/Red liner | 1   |

## 4. Packaging

1 PCS /PE Bag  
Weight: 161g

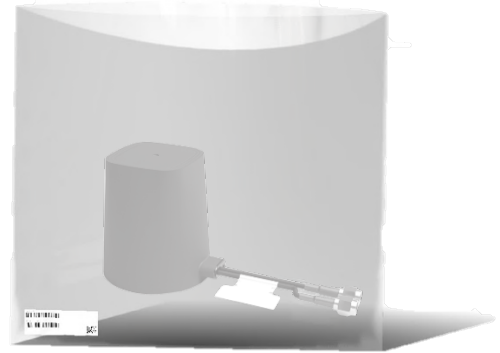

60 PCS / Carton  
Dimensions: 430 x 380 x 280mm  
Weight: 10.76Kg



## 5. Antenna Characteristics

### 5.1 Test Setup

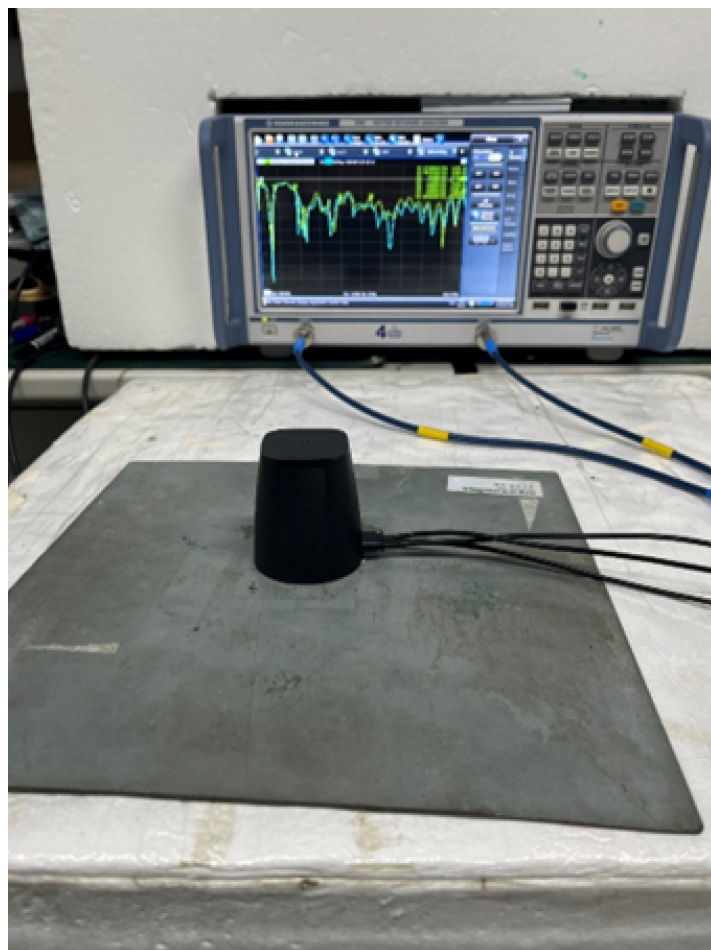
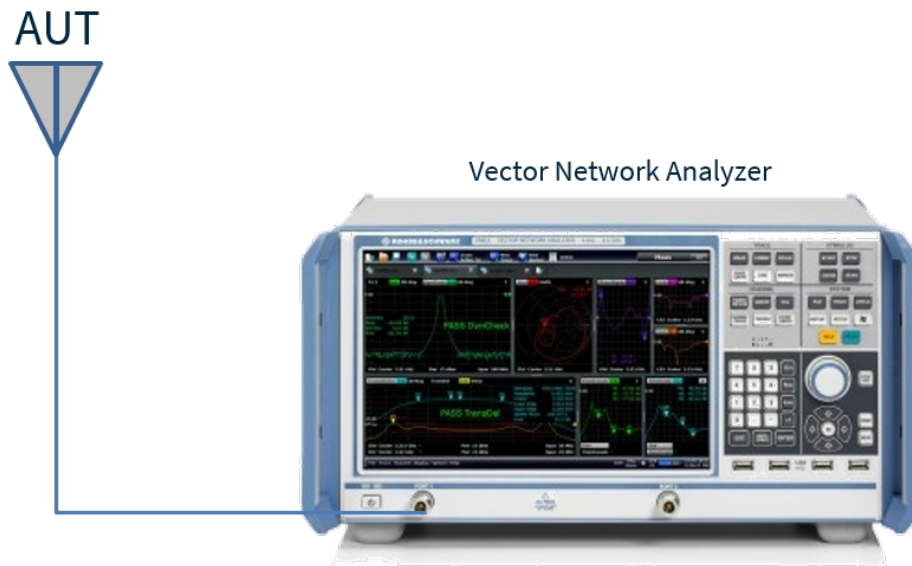

## 5.2 GNSS - Return Loss

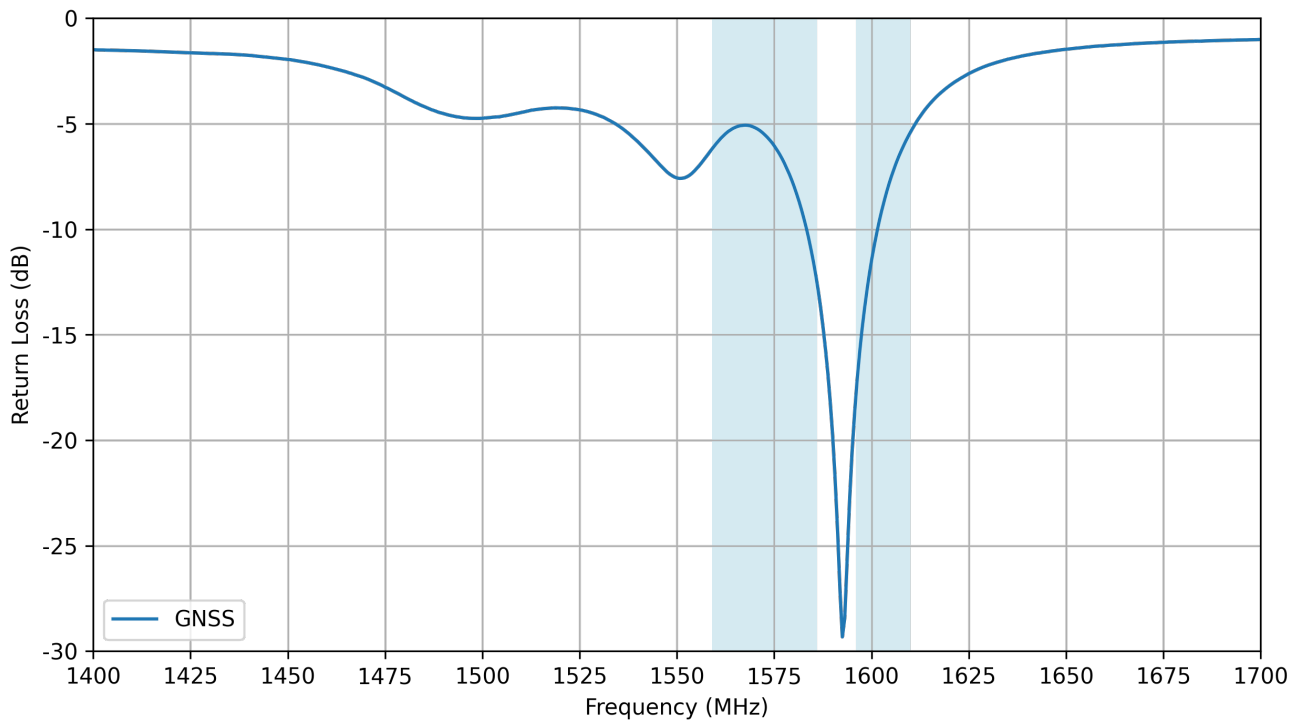

## 5.3 GNSS - VSWR

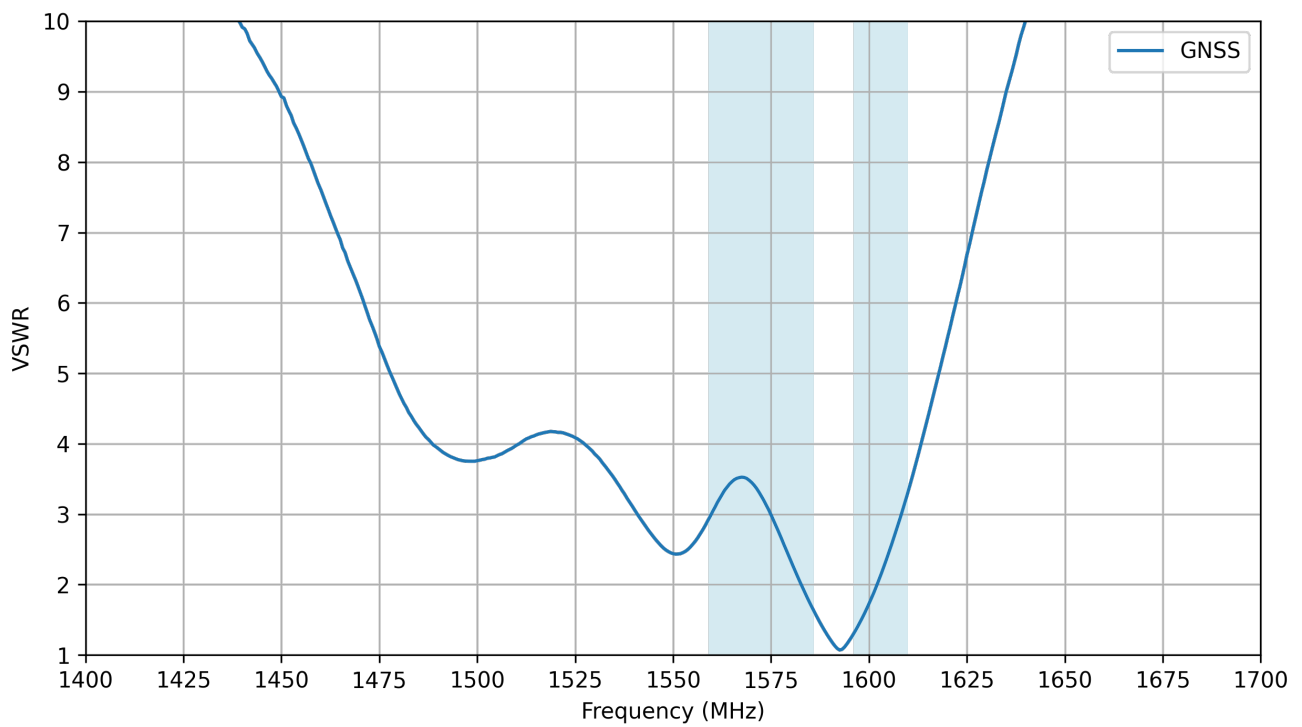

## 5.4 GNSS - Efficiency

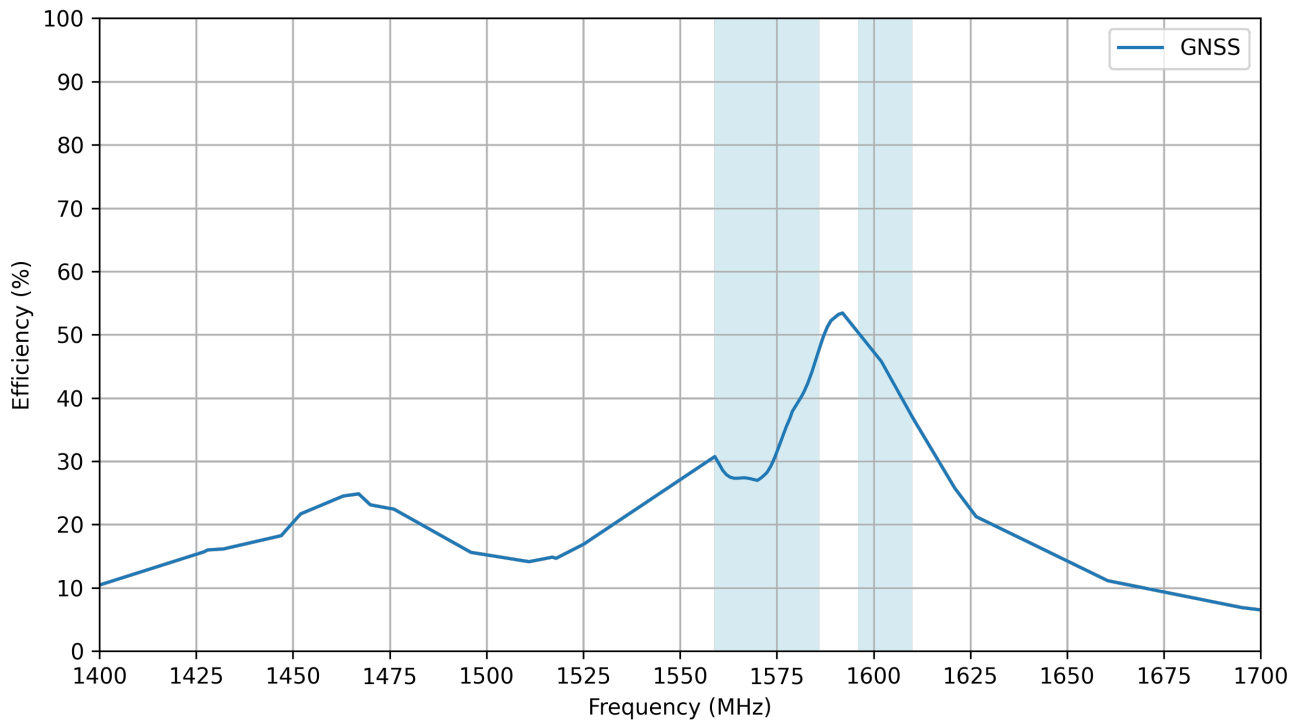

## 5.5 GNSS - Average Gain

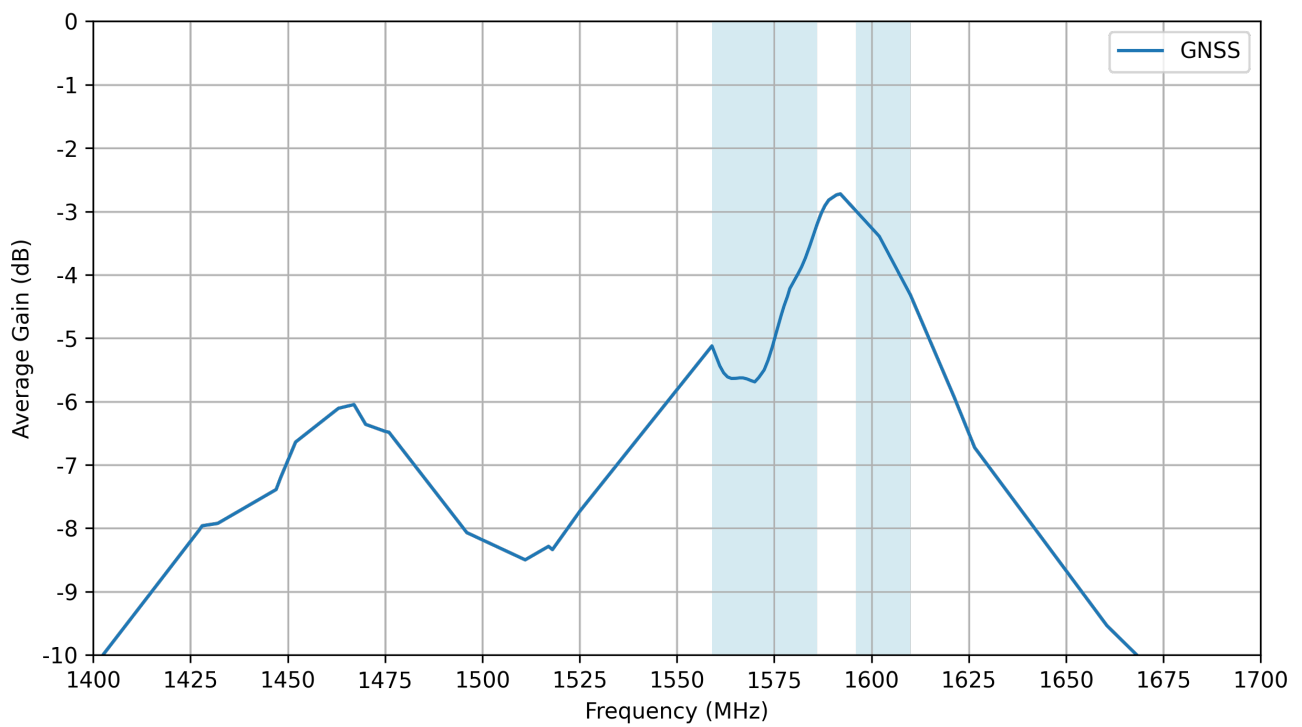



## 5.6 GNSS - Peak Gain (Gtotal)

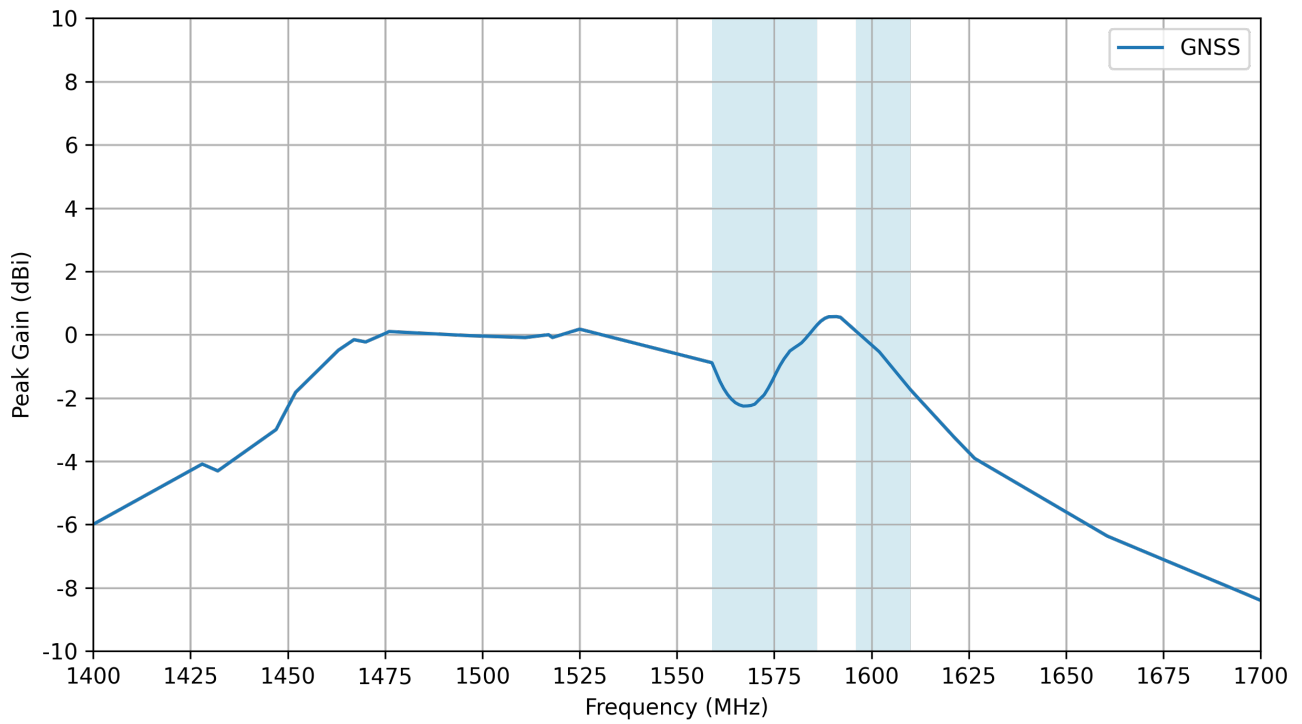

## 5.7 LTE - Return Loss

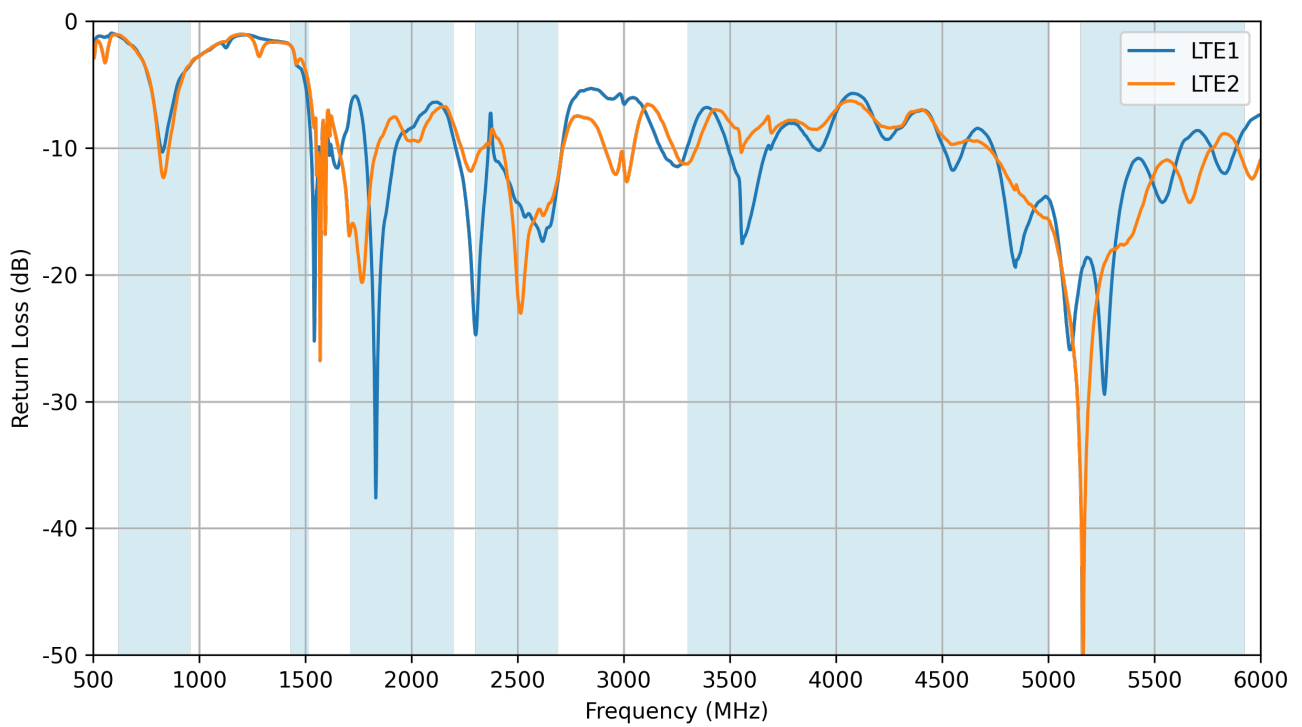

## 5.8 LTE - VSWR

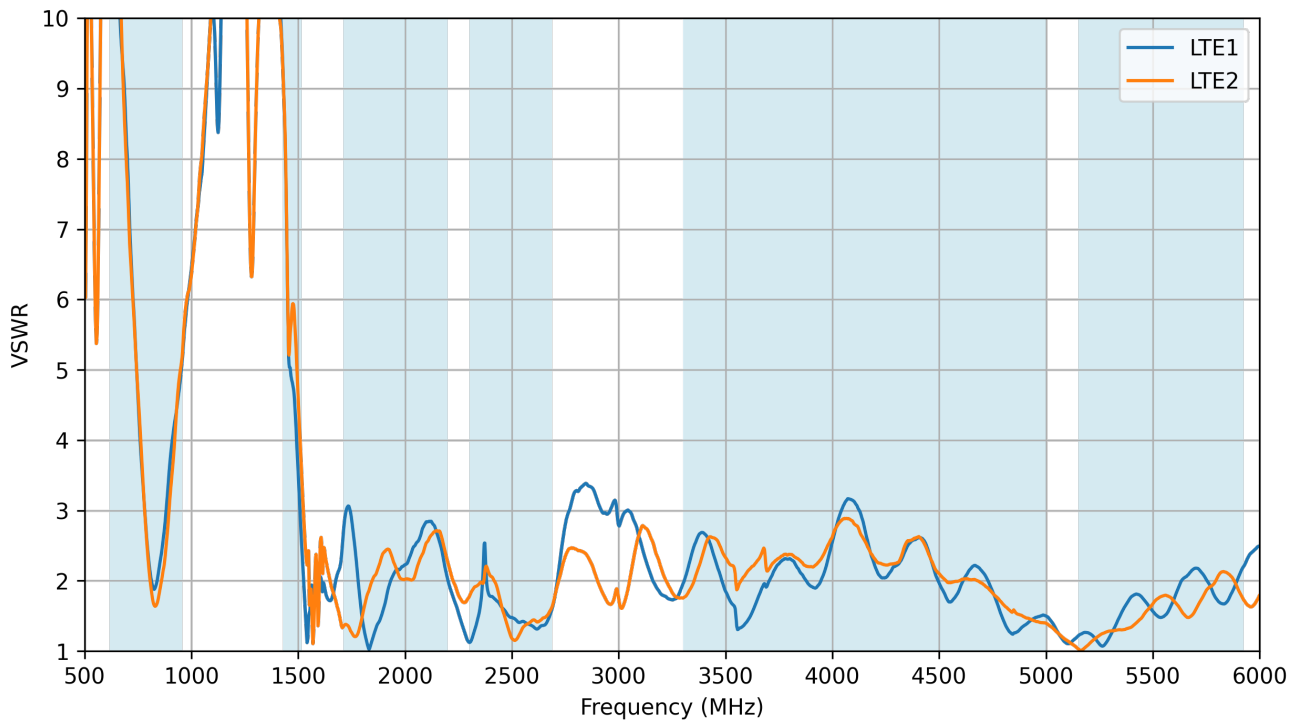

## 5.9 LTE - Efficiency

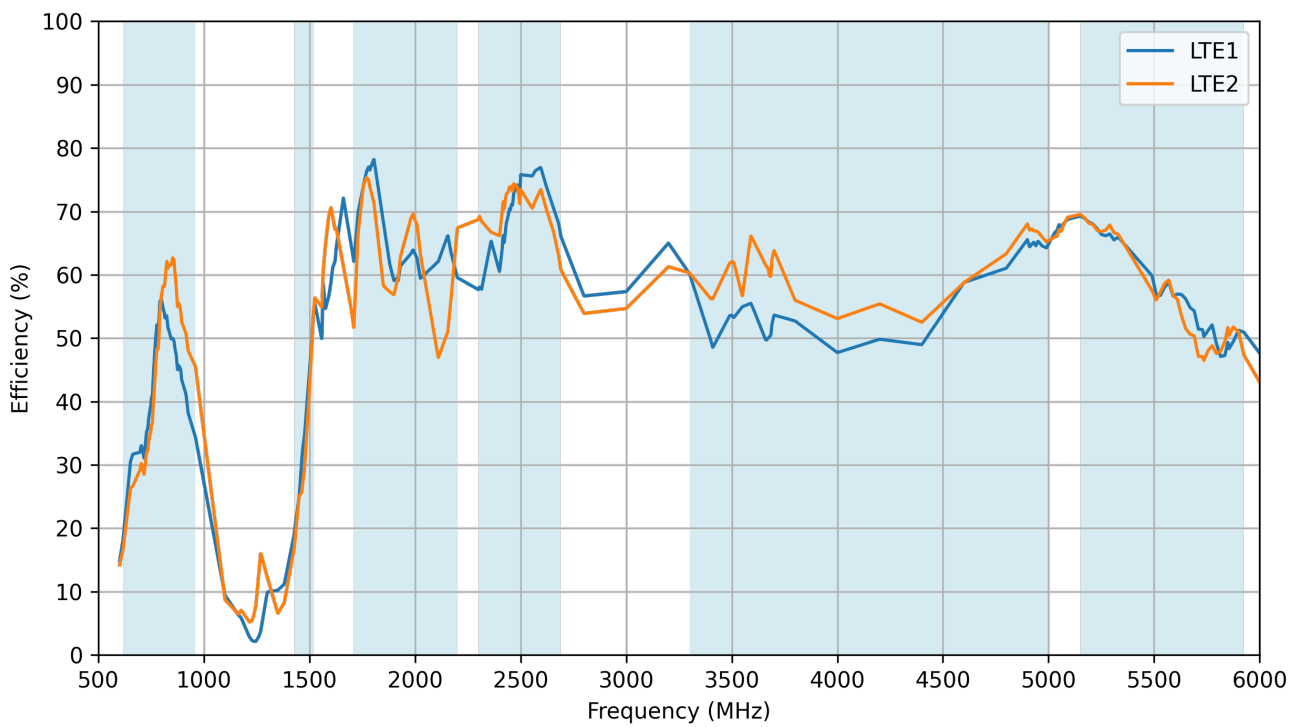

### 5.10 LTE - Average Gain

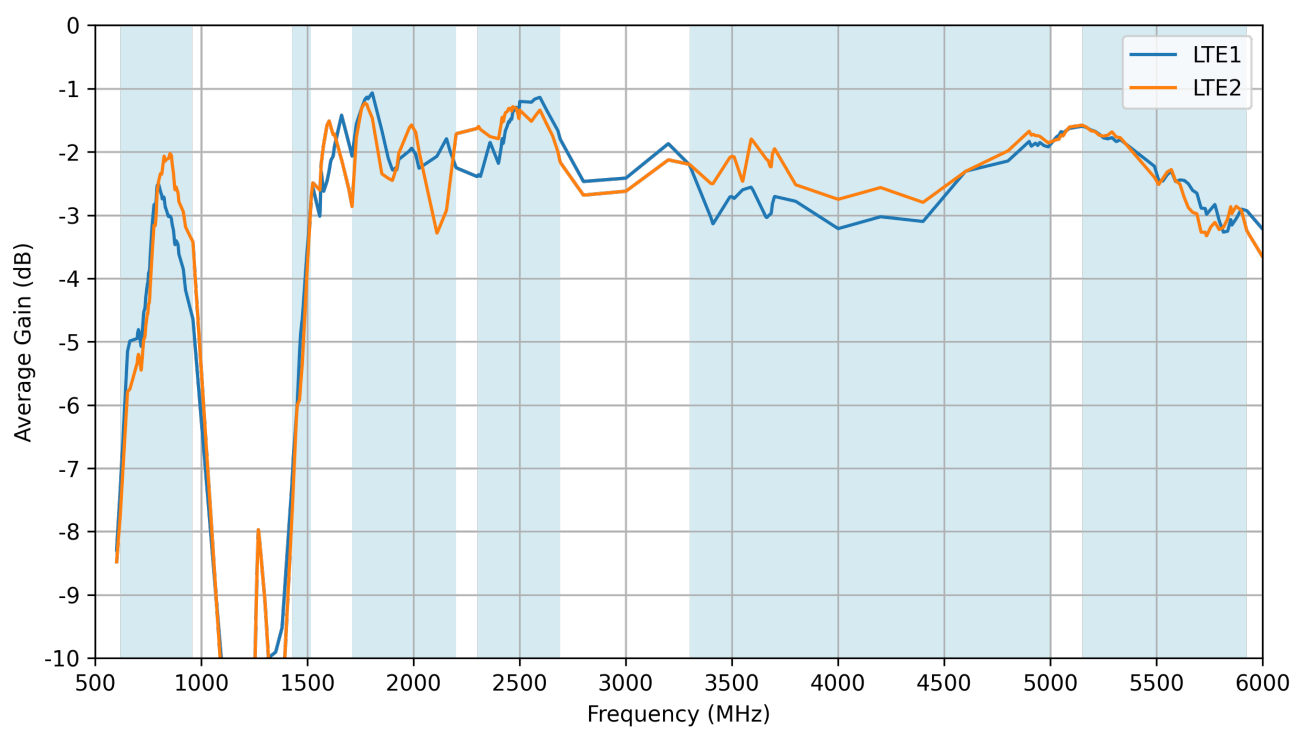

### 5.11 LTE - Peak Gain

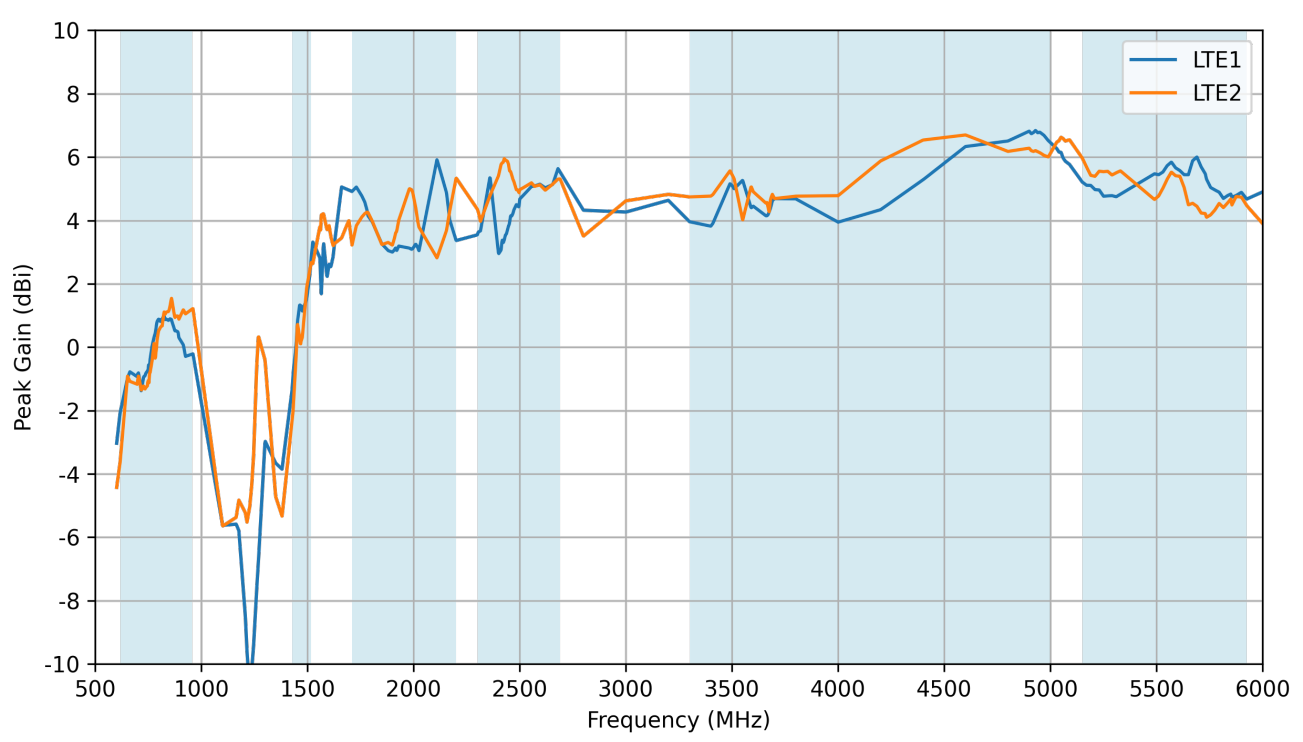

## 6. LNA Characteristics

### 6.1 Block Diagram

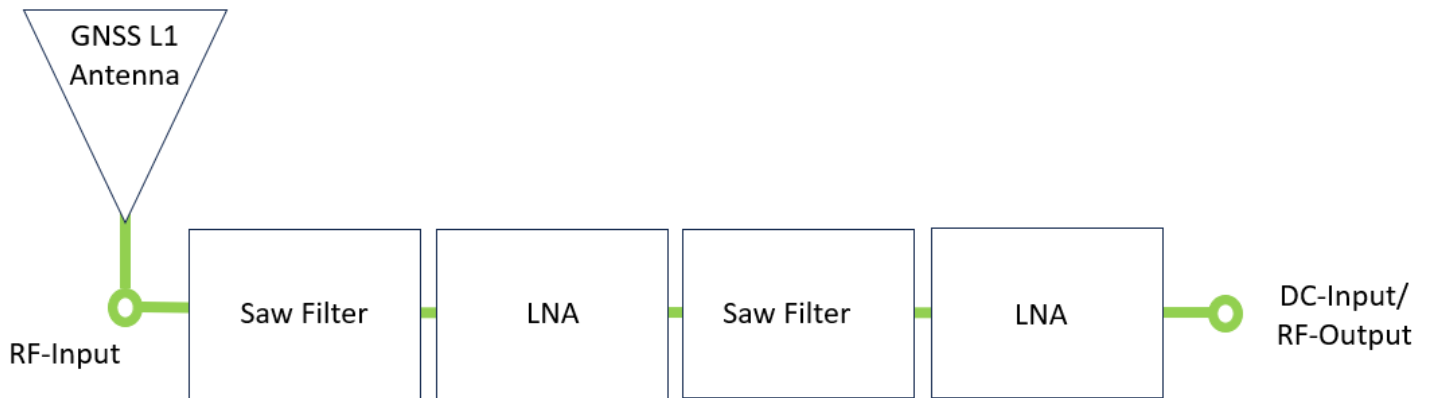

### 6.2 Gain

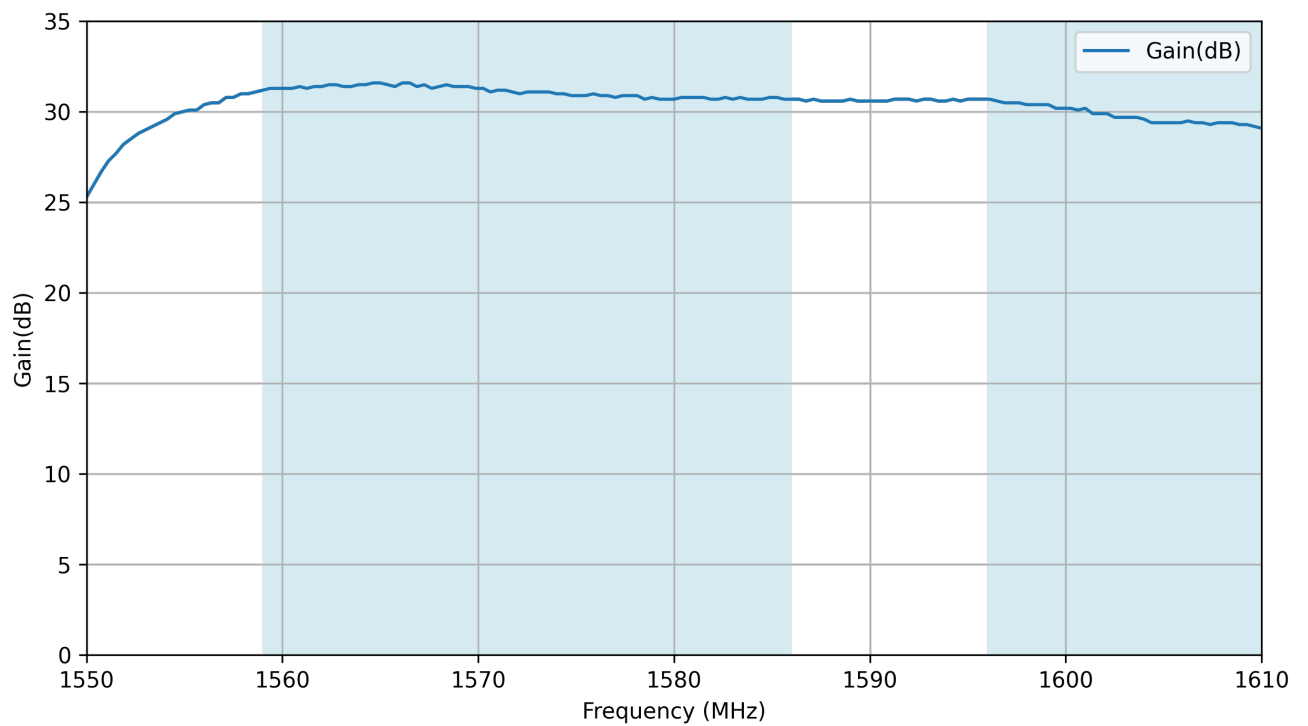

### 6.3 Noise Figure

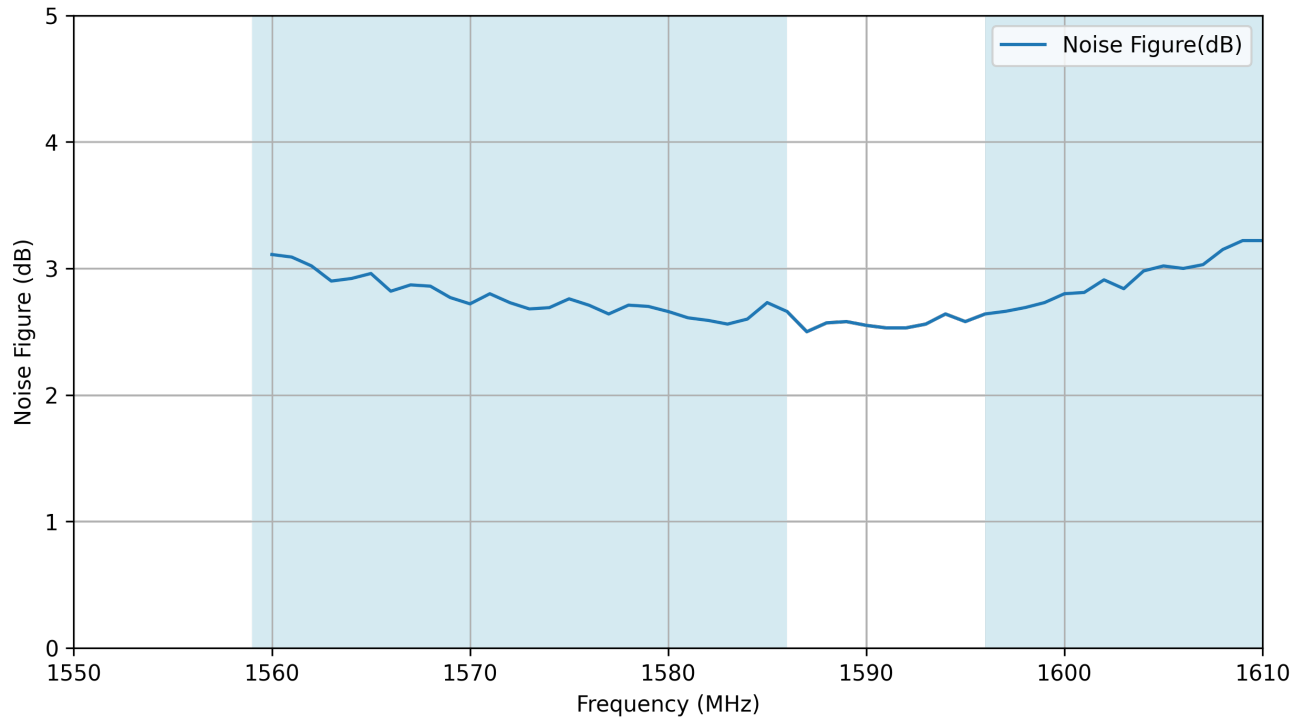

### 6.4 Wide Band Gain

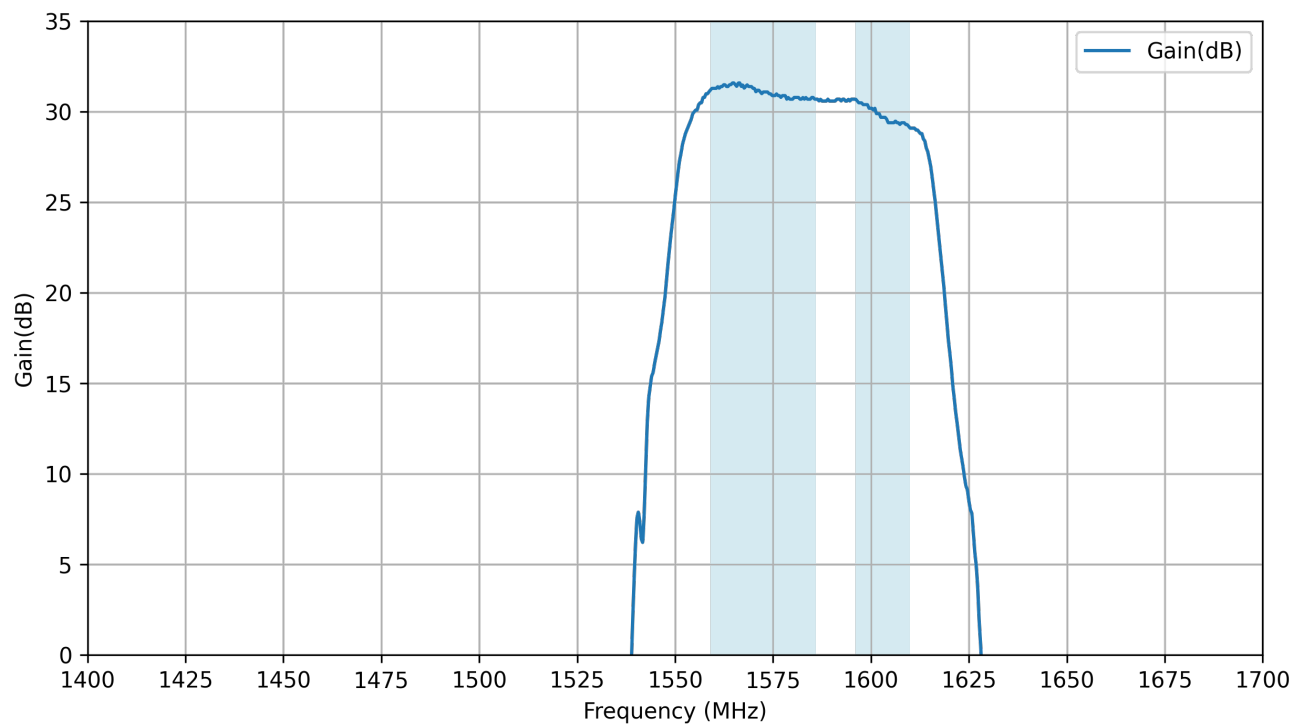

## 6.5 Out Of Band Rejection

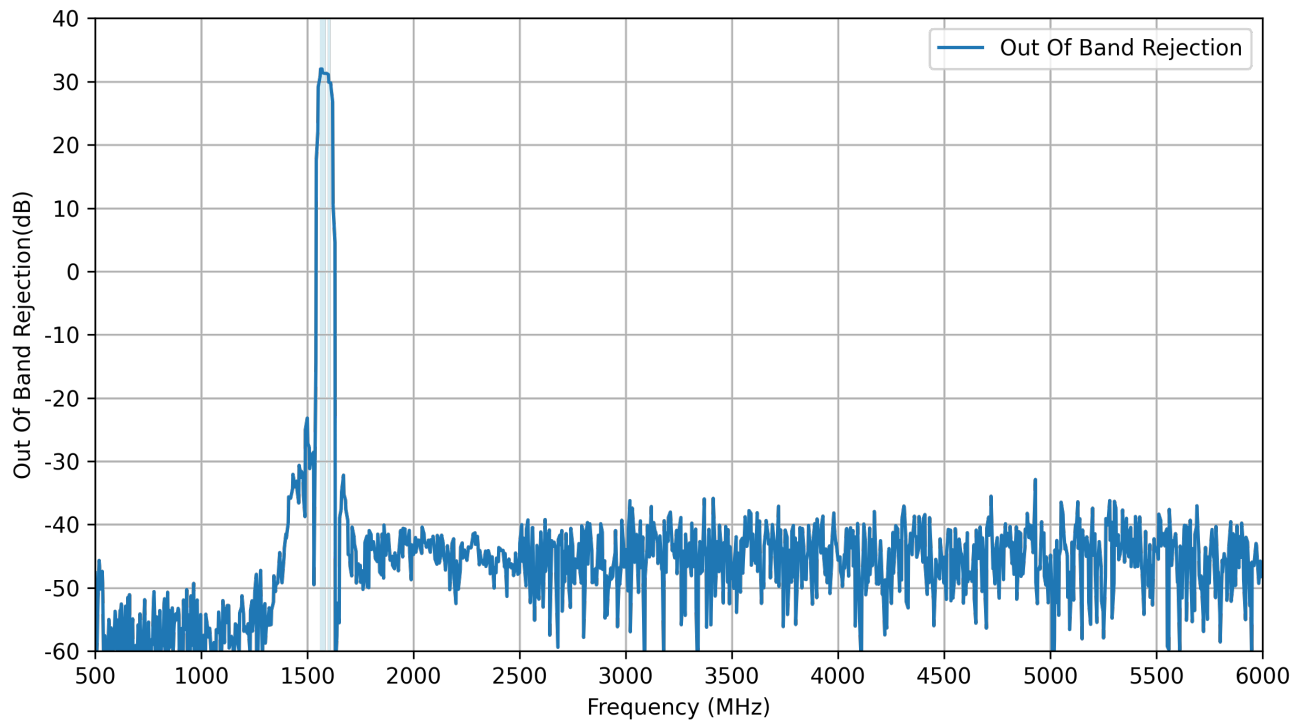

## 6.6 Group Delay

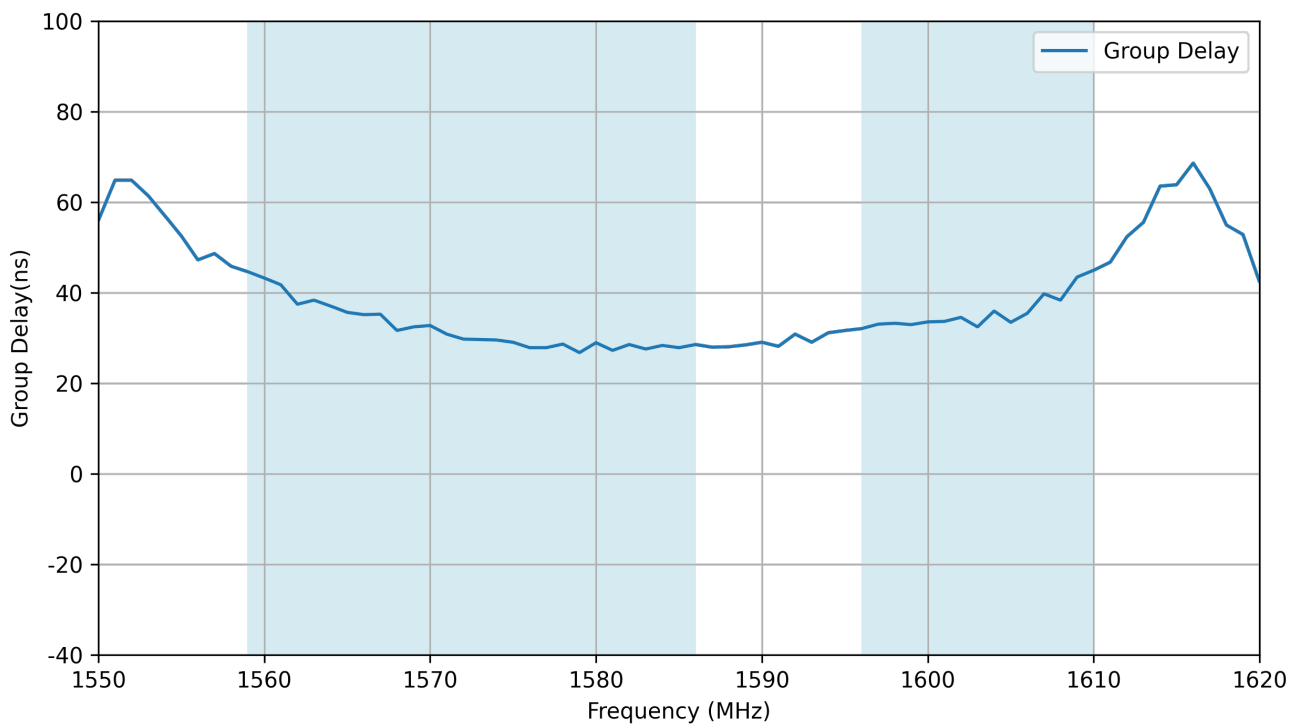

# 7. Radiation Patterns

## 7.1 Test Setup

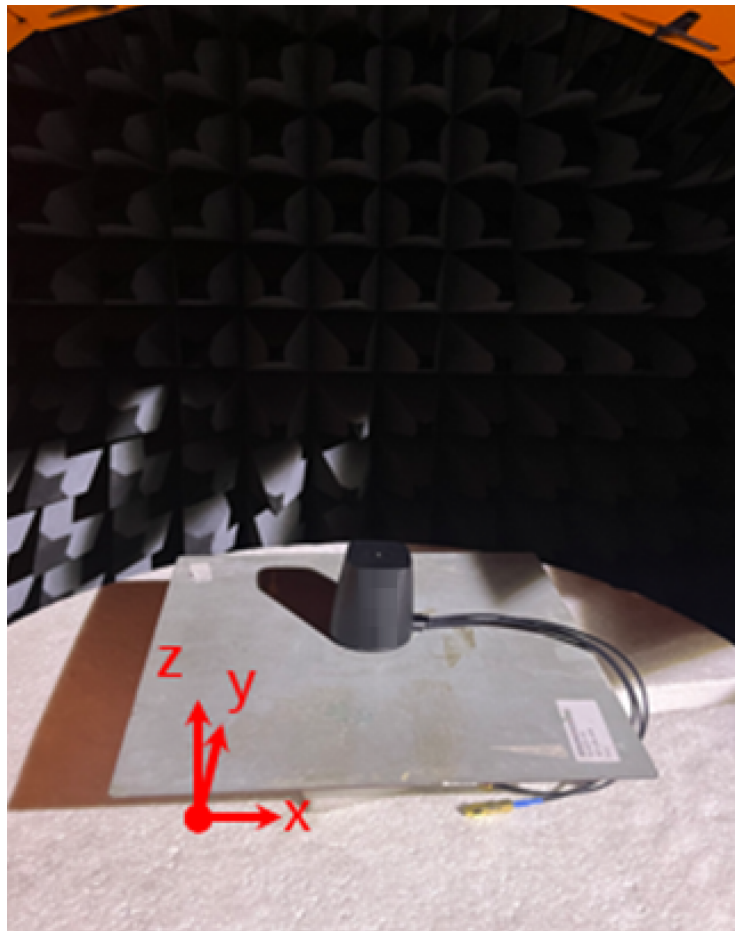
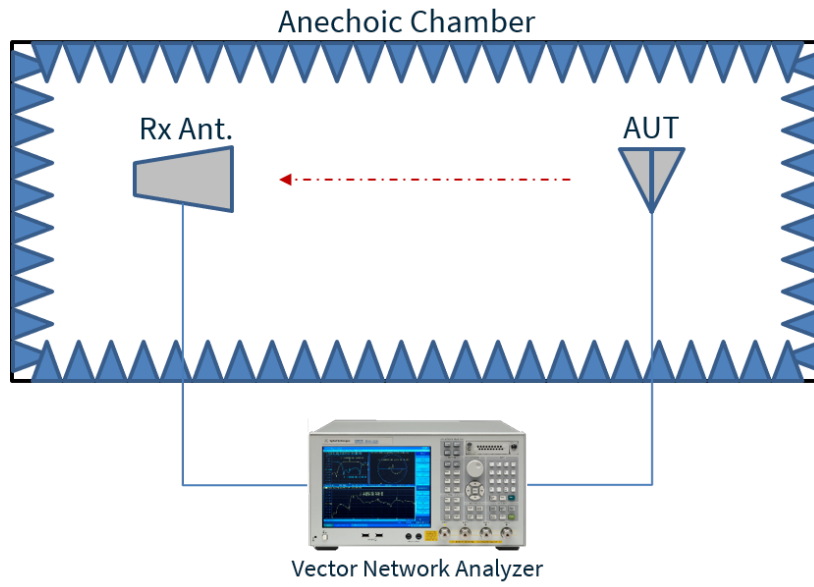

Chamber Set-up on 30x30cm Ground Plane



## 7.2 GNSS Patterns at 1576 MHz

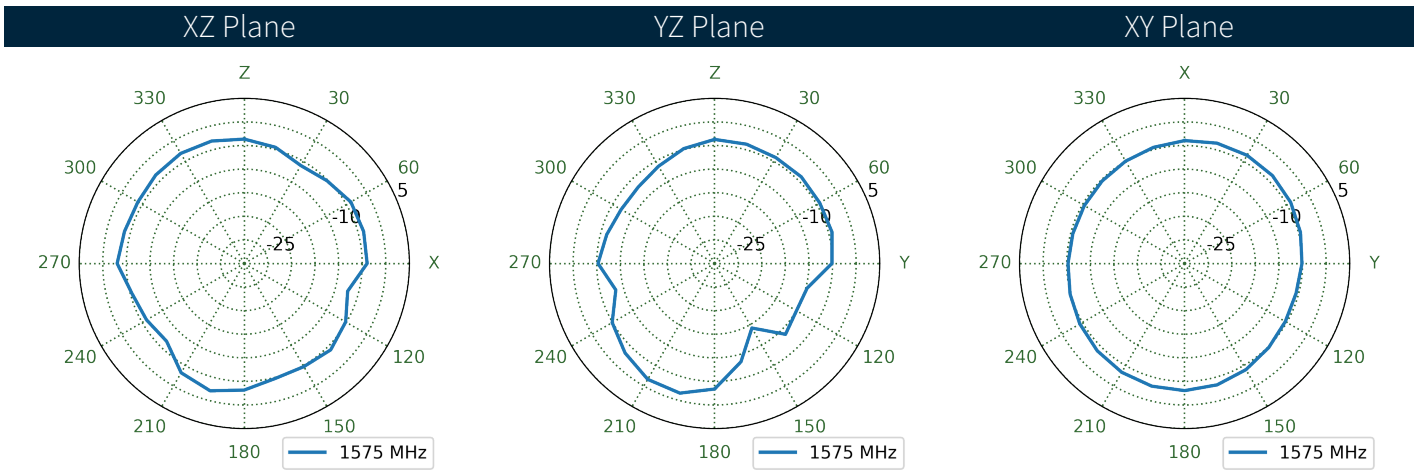
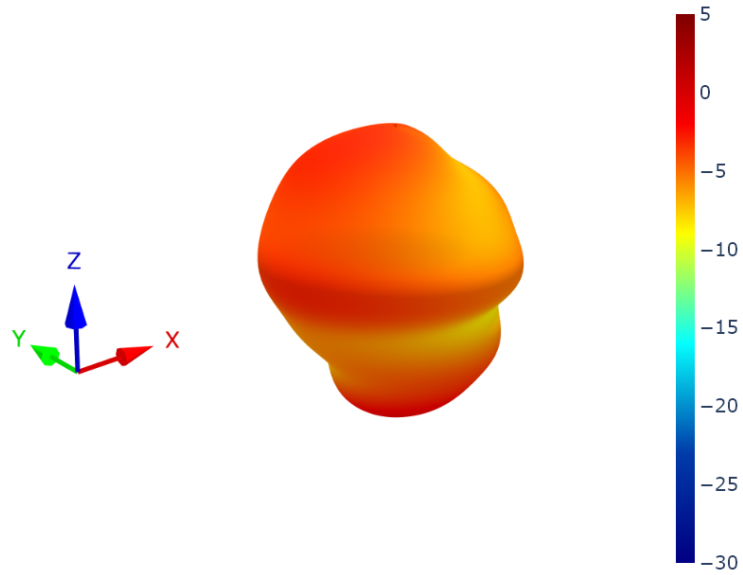

## 7.3 GNSS Patterns at 1562 MHz

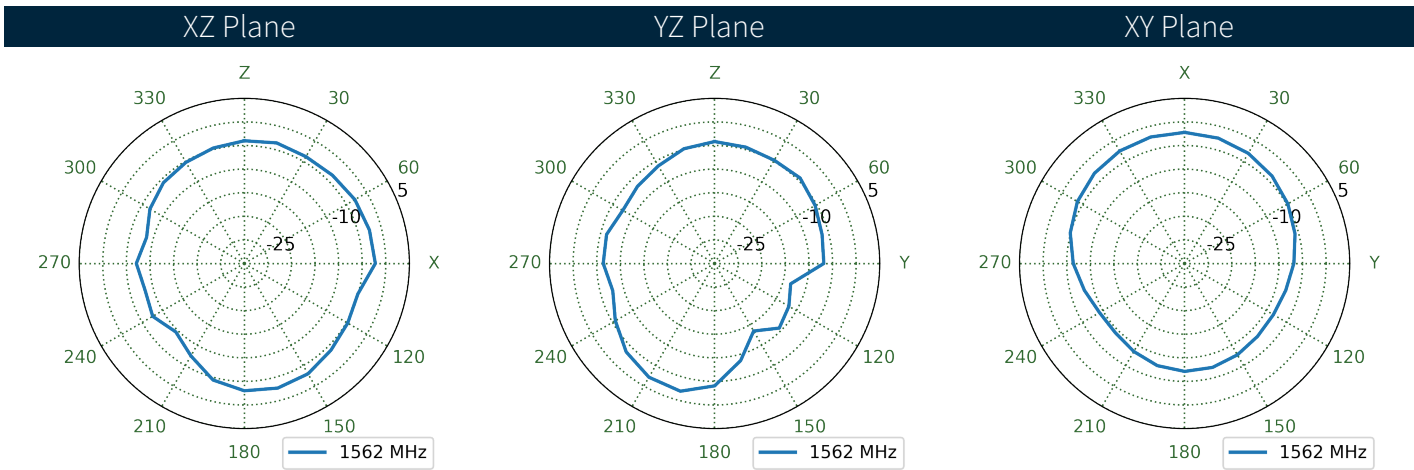
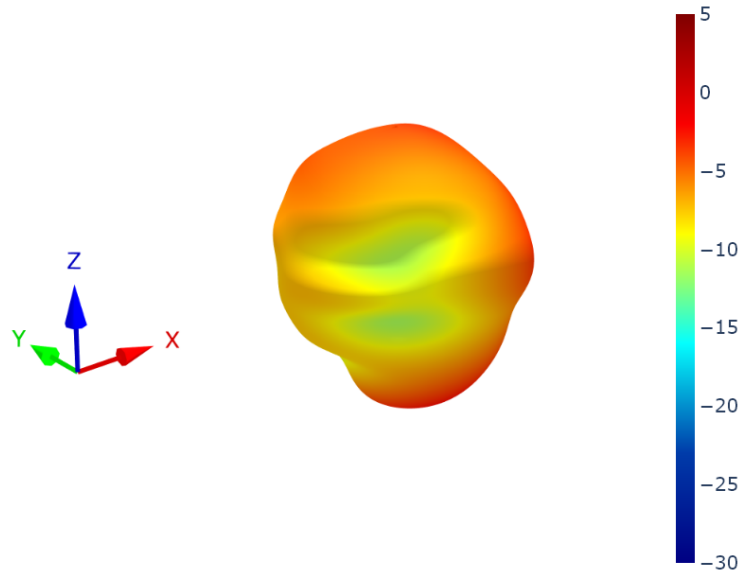

7.4 GNSS Patterns at 1602 MHz

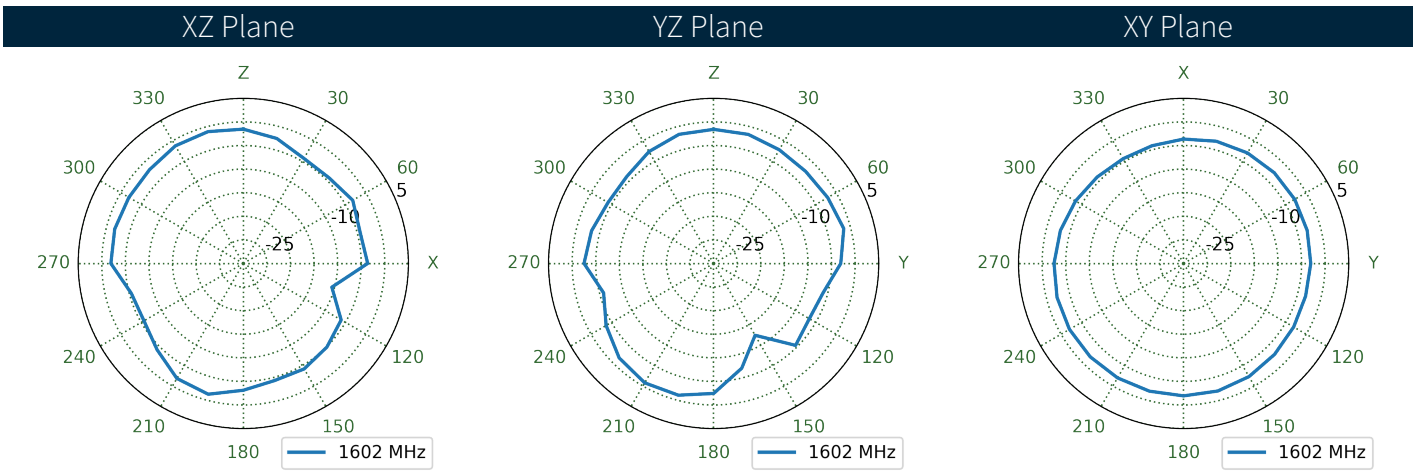
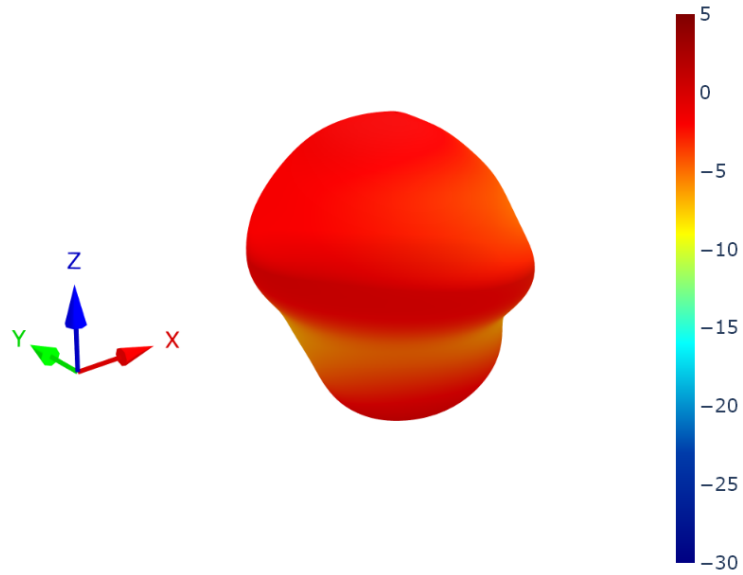

7.5 LTE1 Patterns at 650 MHz

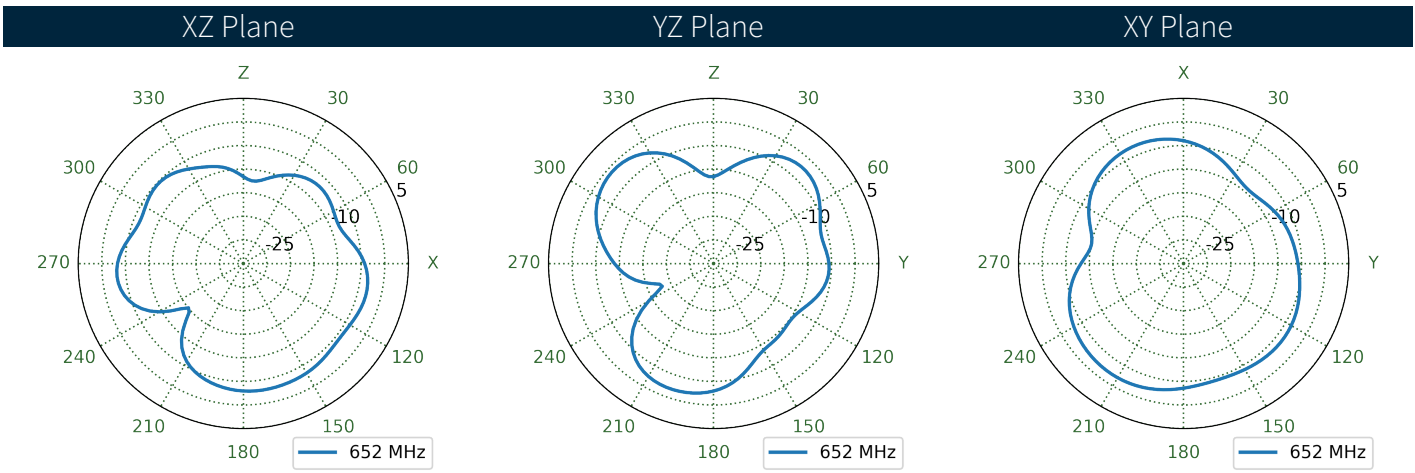
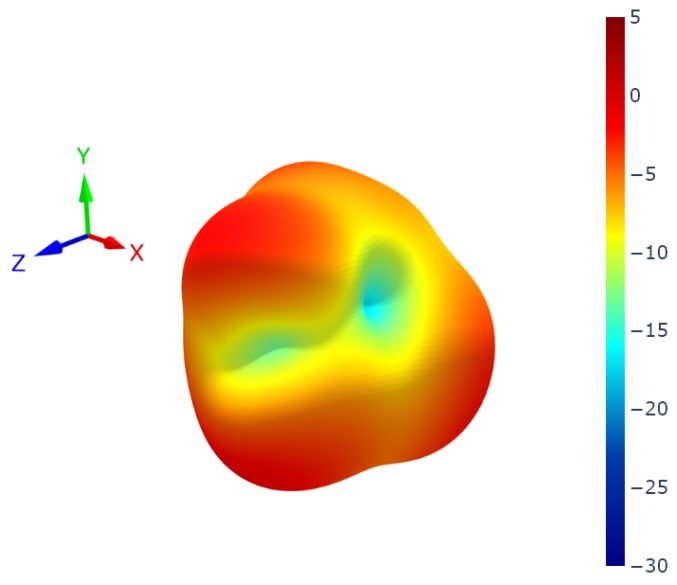

7.6 LTE2 Patterns at 650 MHz

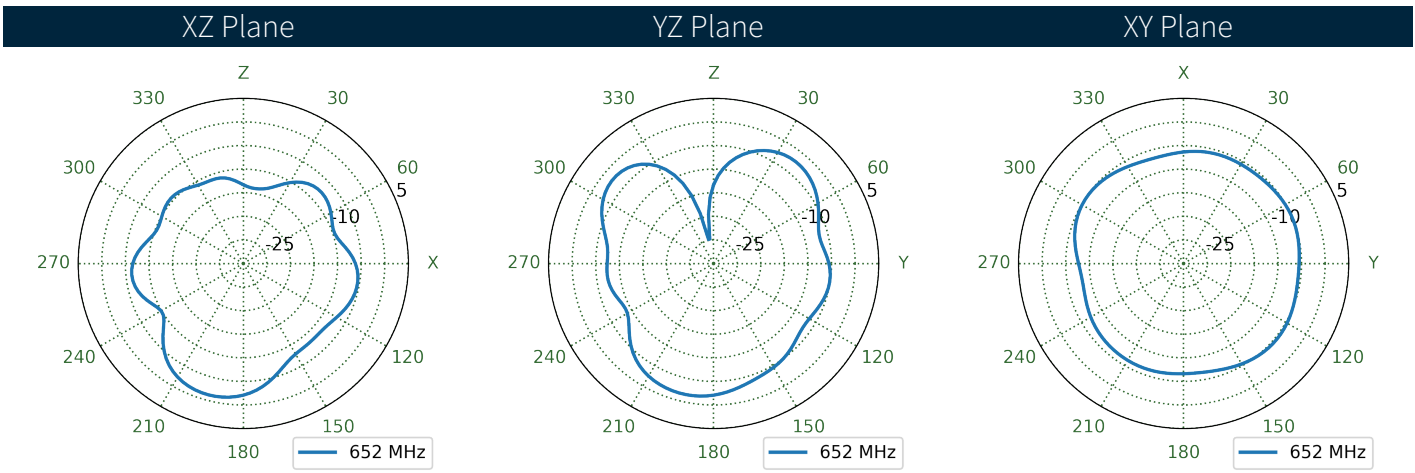
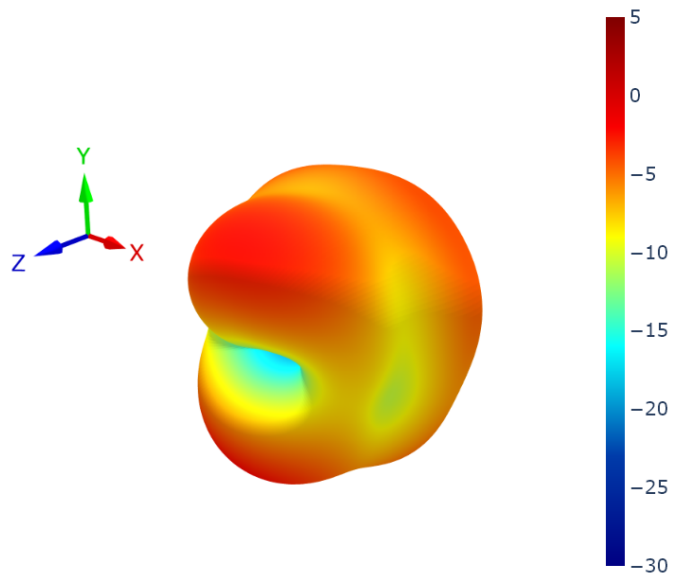

7.7 LTE1 Patterns at 750 MHz

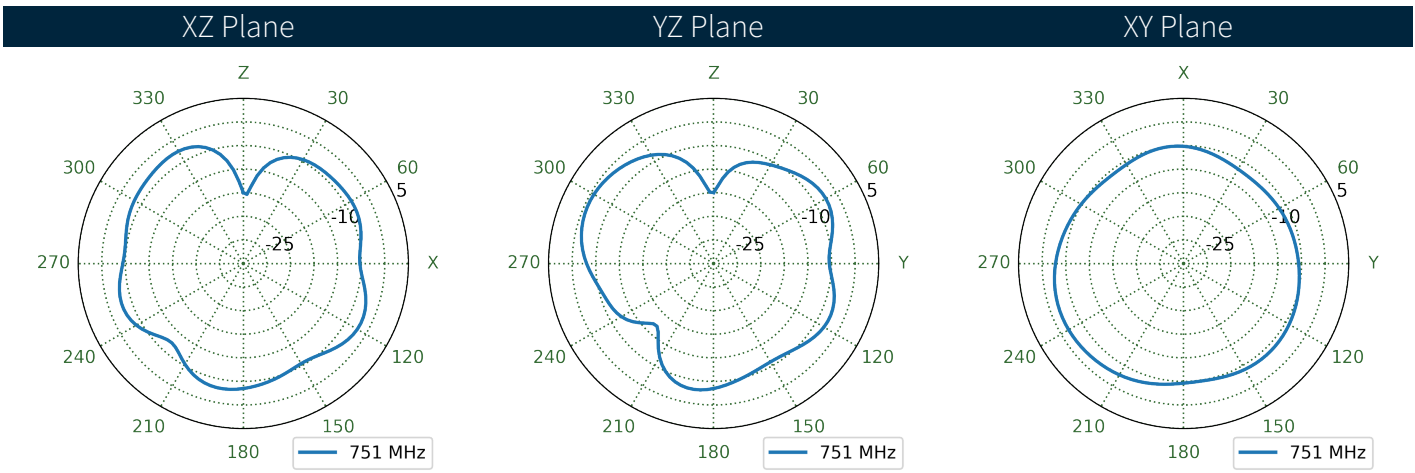
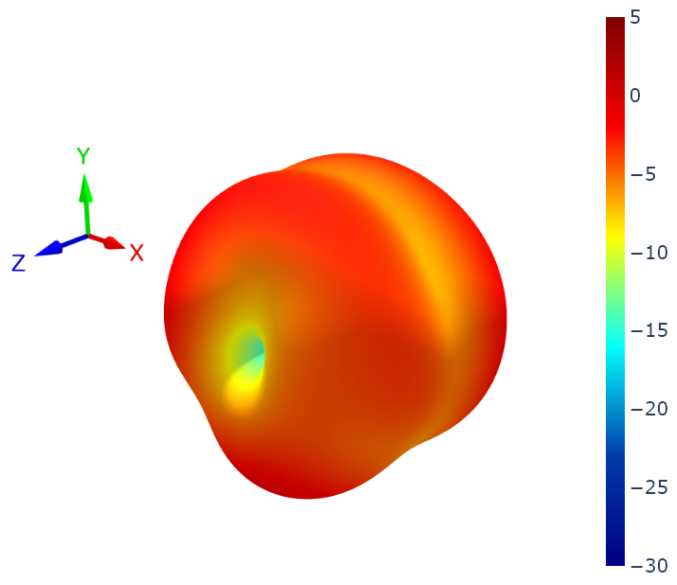

7.8 LTE2 Patterns at 750 MHz

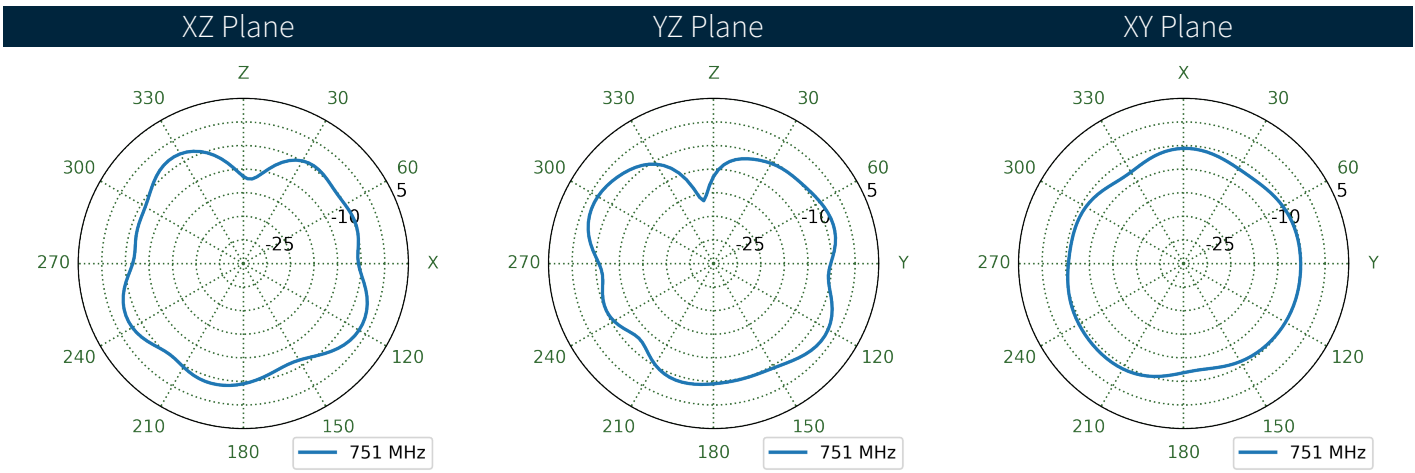
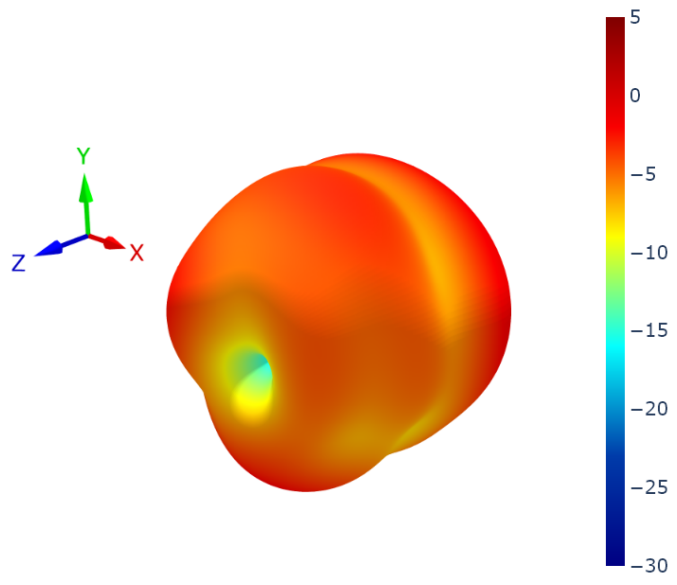



7.9 LTE1 Patterns at 890 MHz

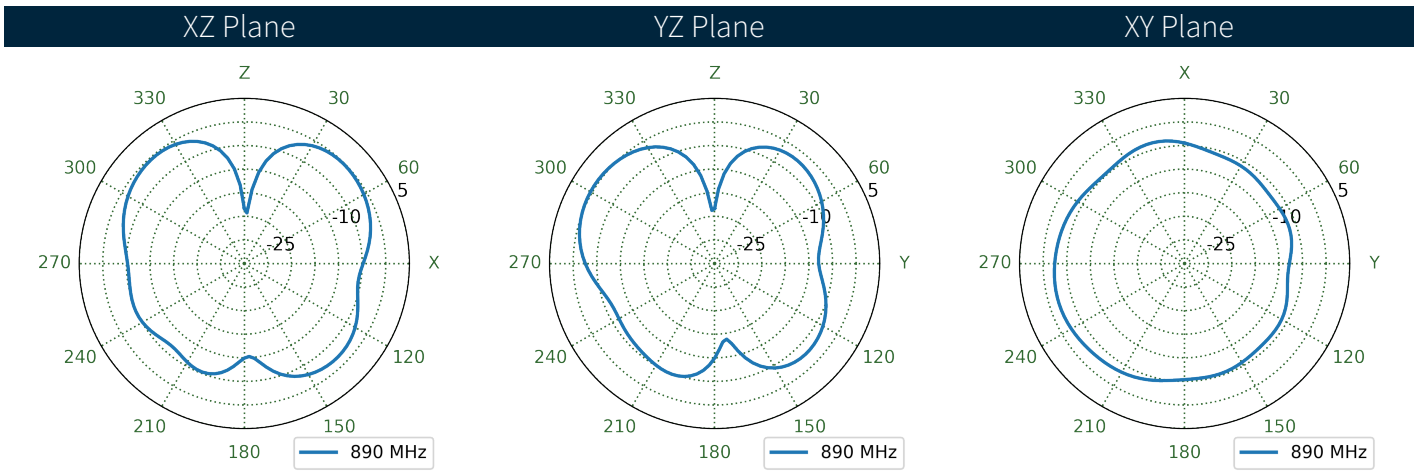
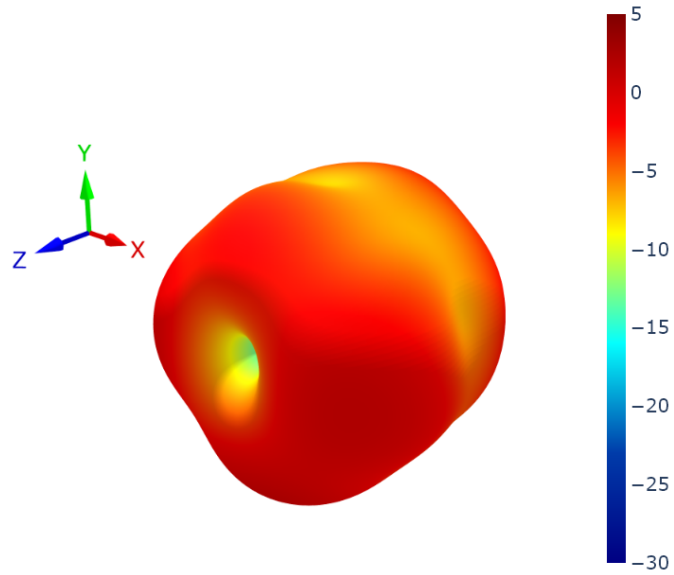

7.10 LTE2 Patterns at 890 MHz

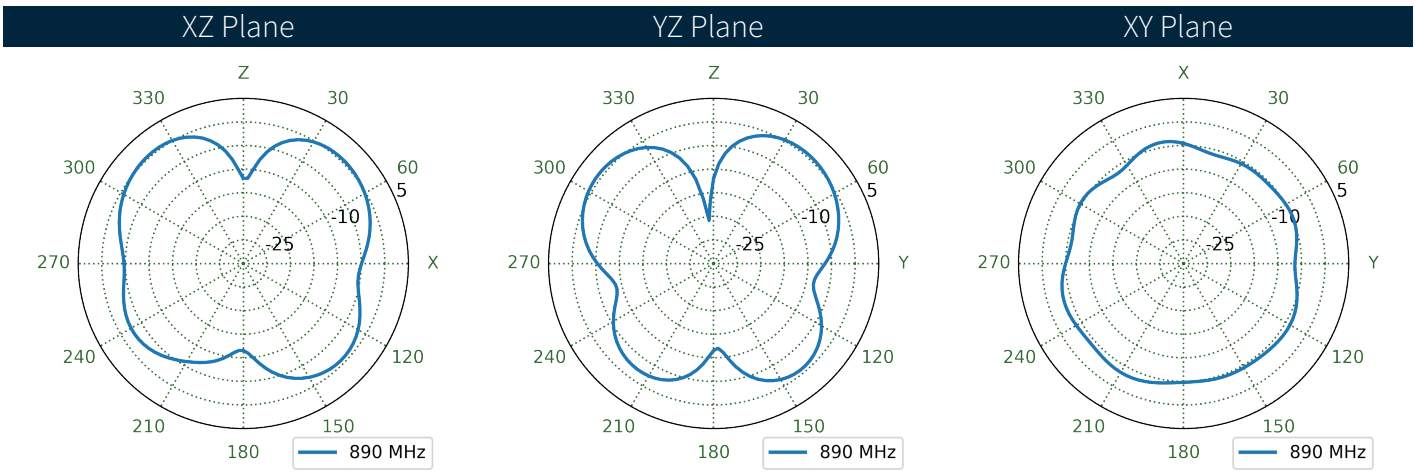
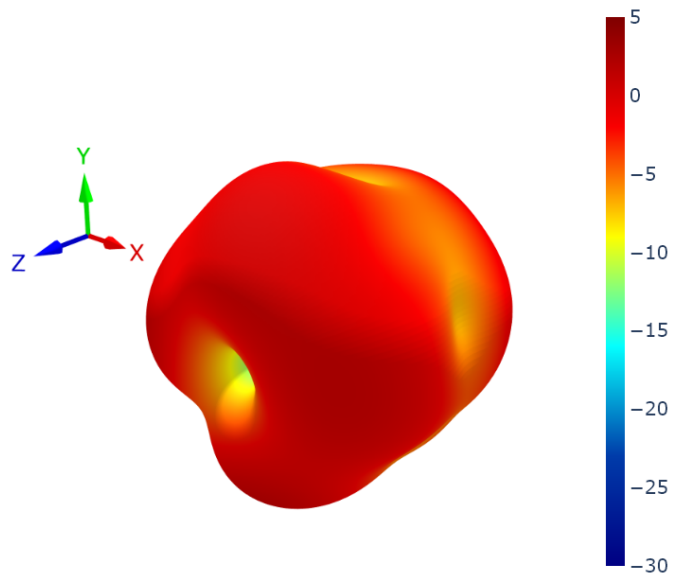

7.11 LTE1 Patterns at 1470 MHz

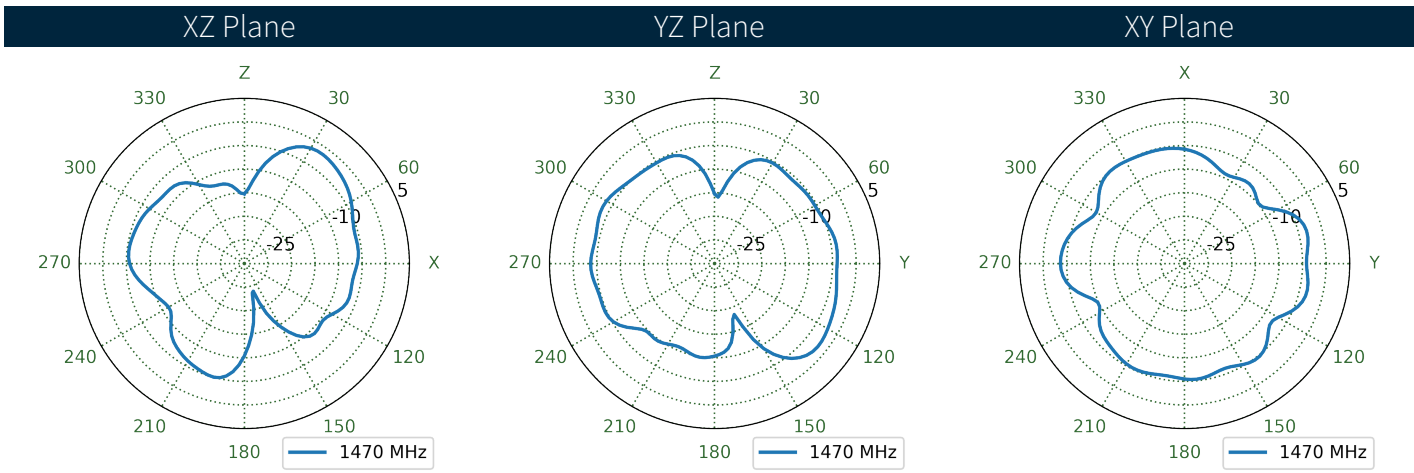
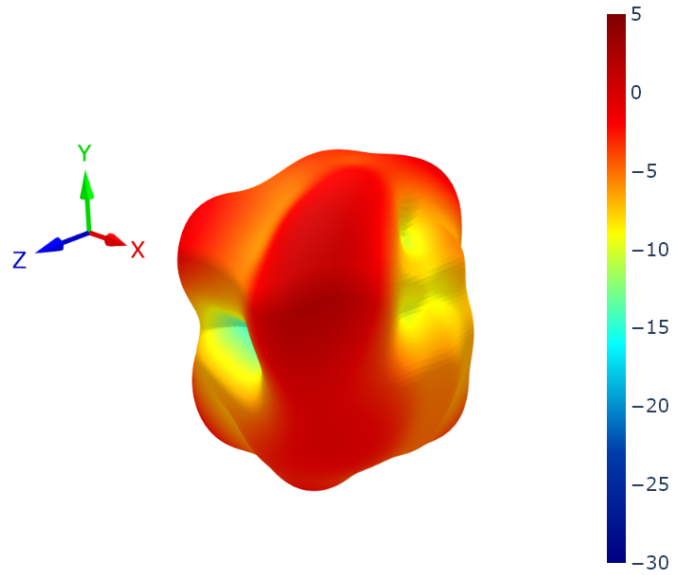

## 7.12 LTE2 Patterns at 1470 MHz

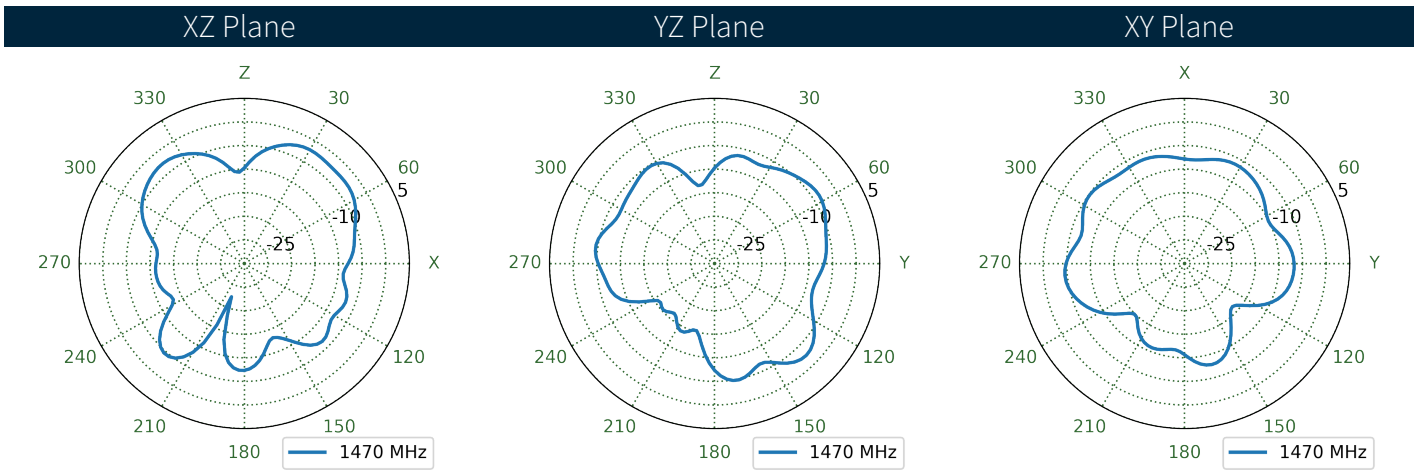
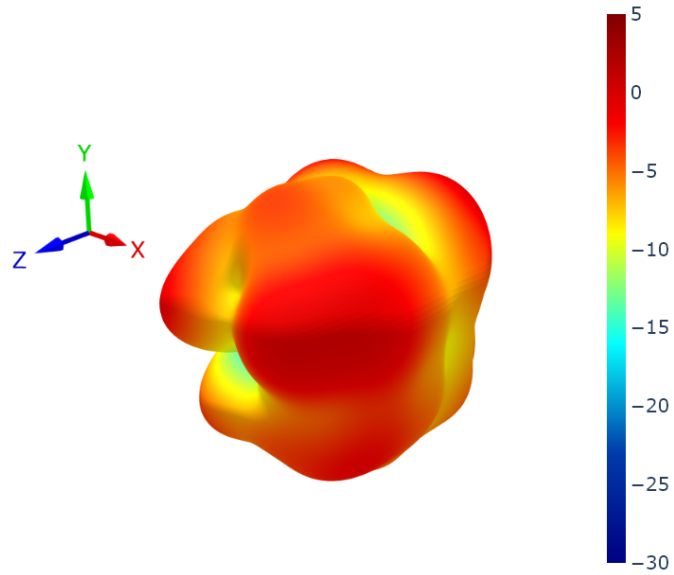

7.13 LTE1 Patterns at 1805 MHz

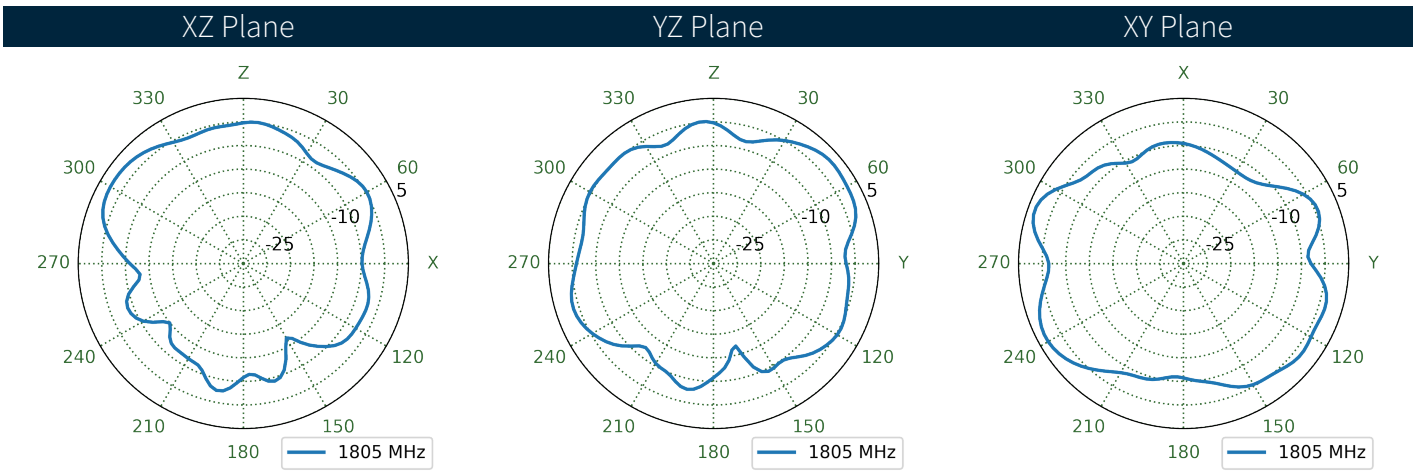
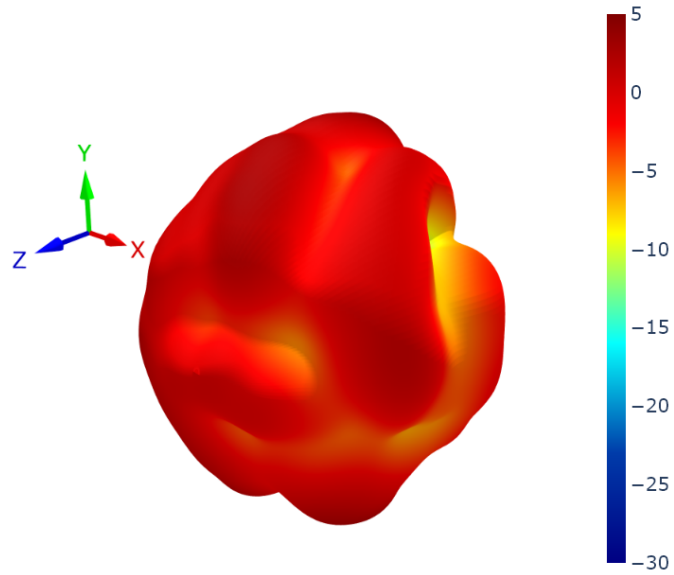

7.14 LTE2 Patterns at 1805 MHz

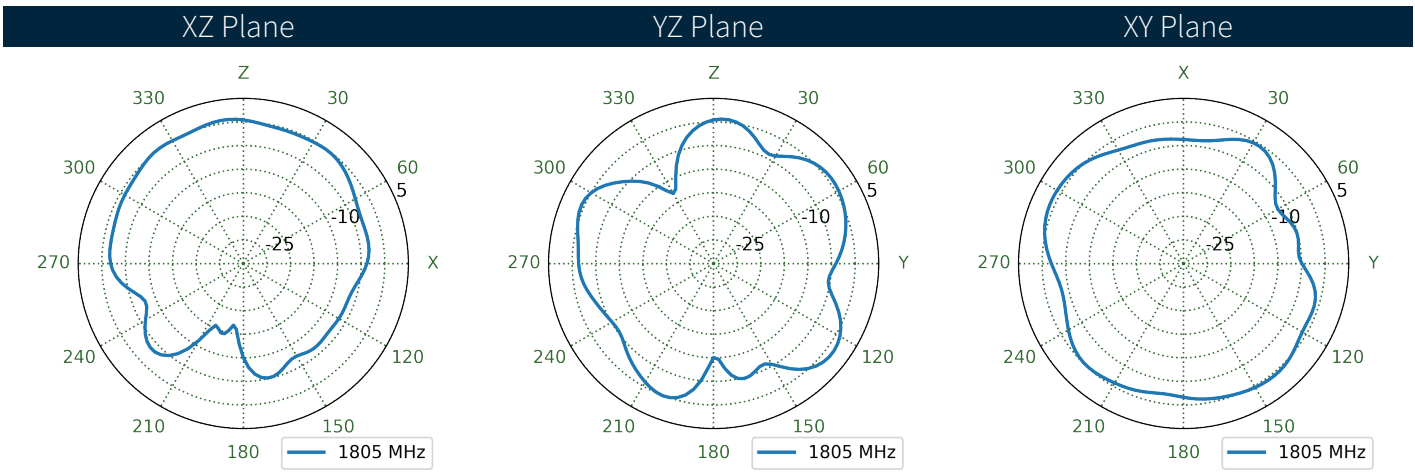
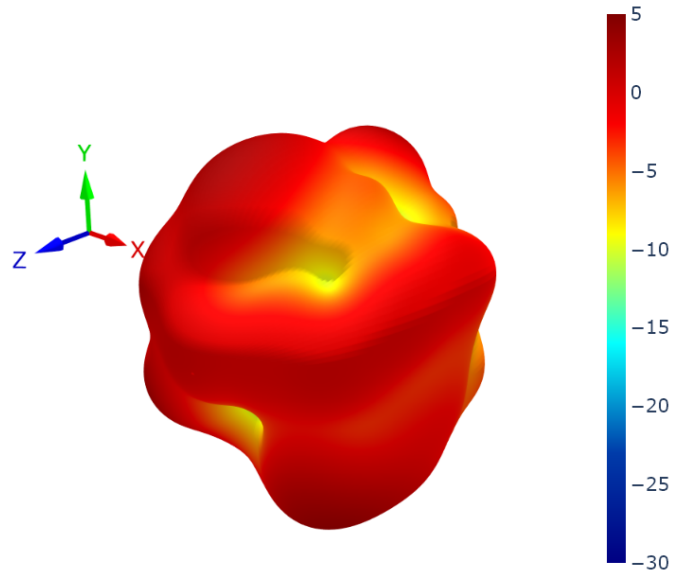

7.15 LTE1 Patterns at 1920 MHz

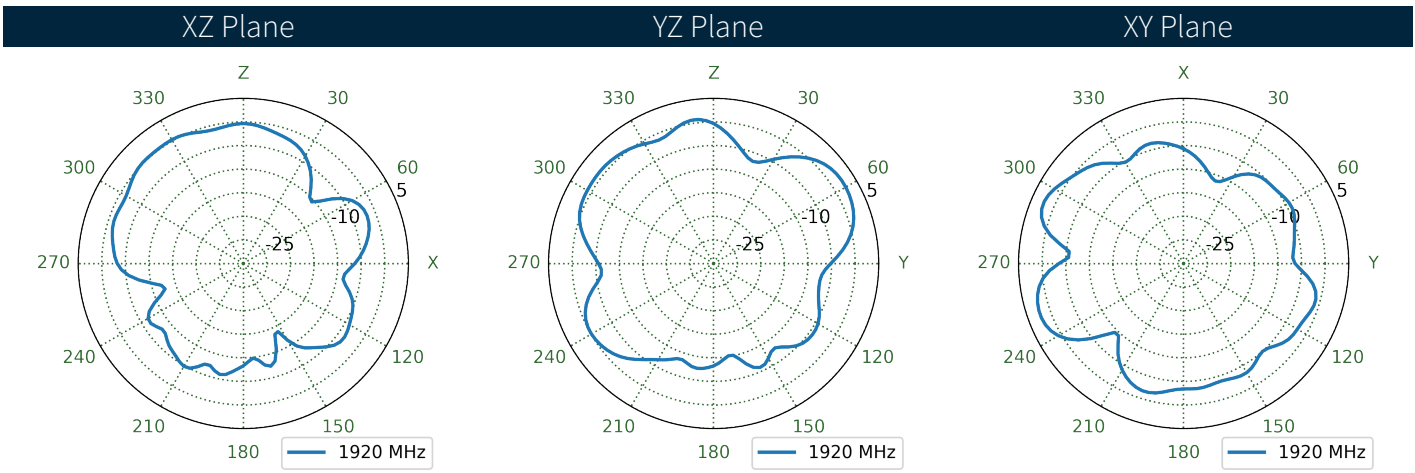
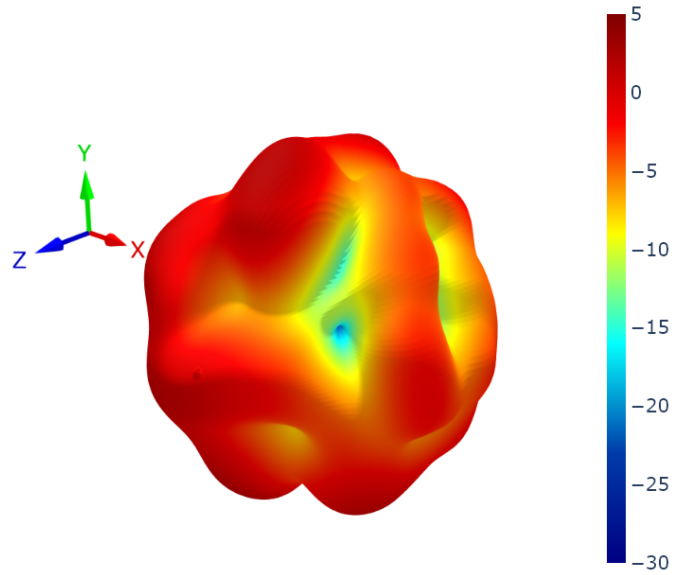

7.16 LTE2 Patterns at 1920 MHz

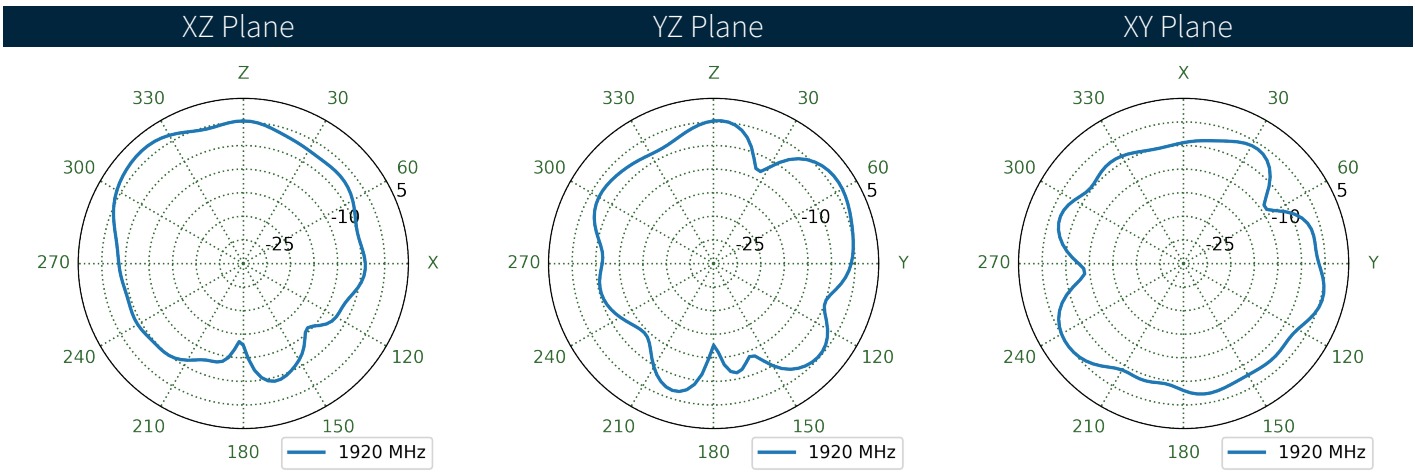
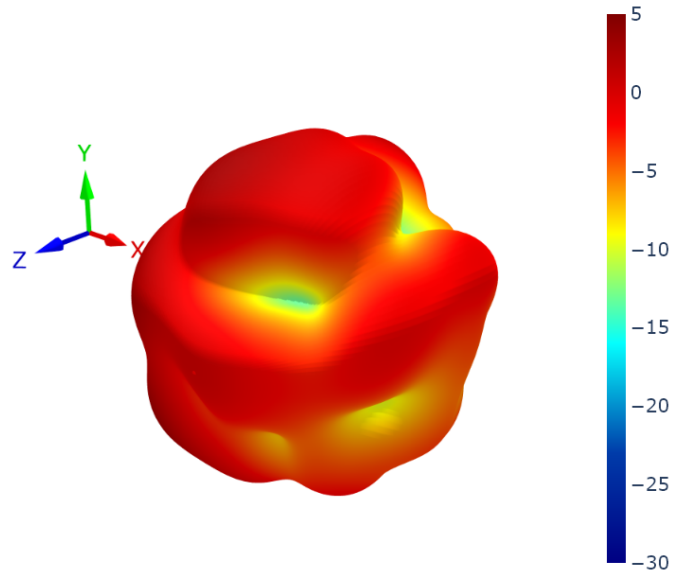



7.17 LTE1 Patterns at 1990 MHz

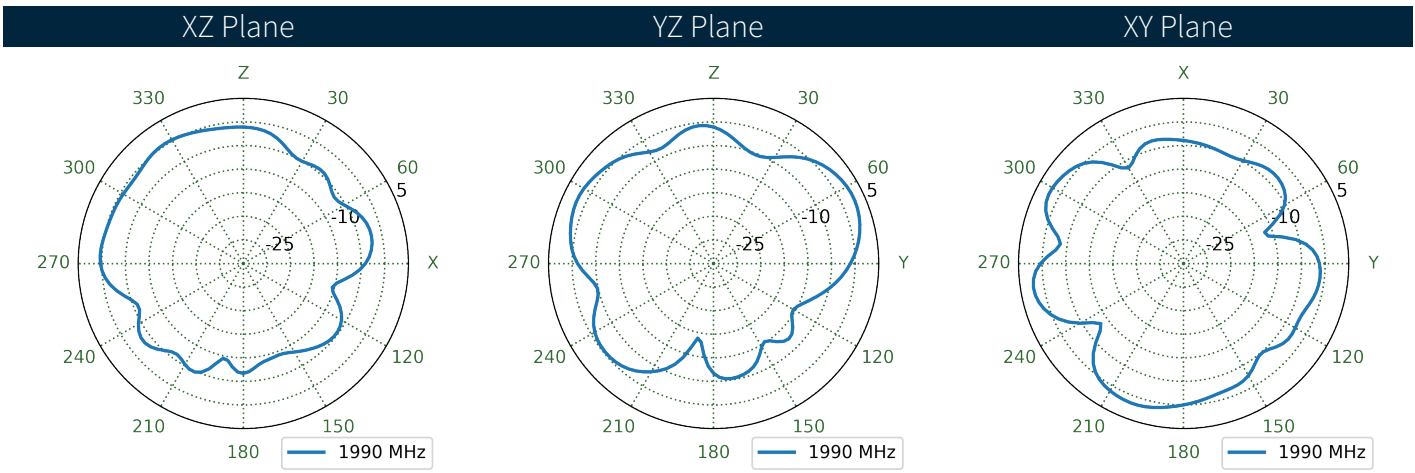
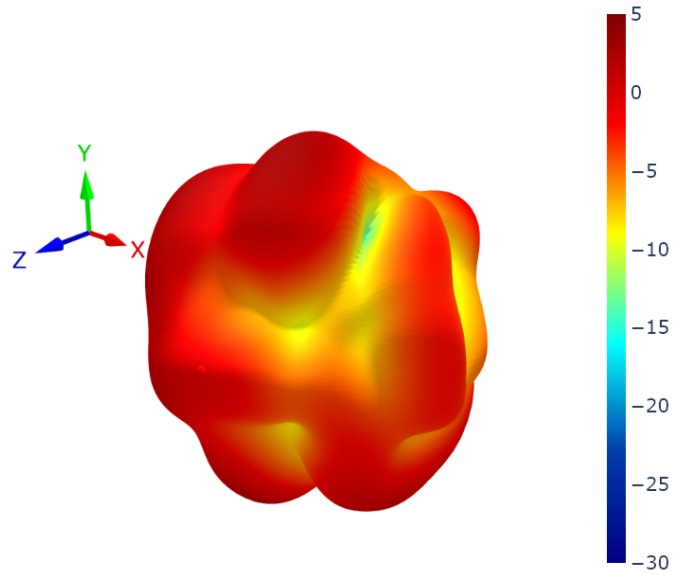

7.18 LTE2 Patterns at 1990 MHz

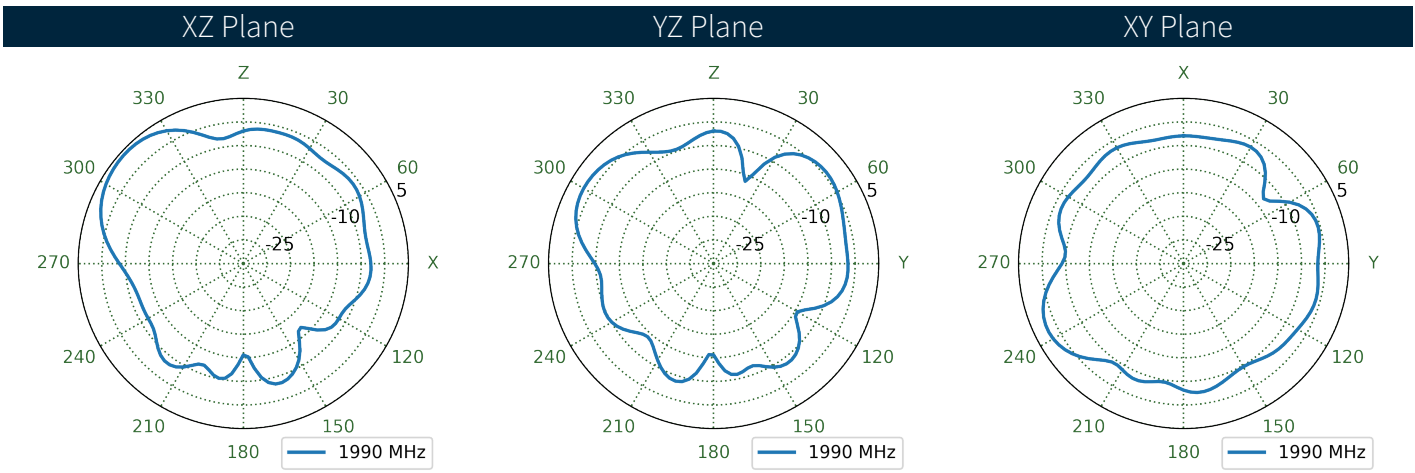
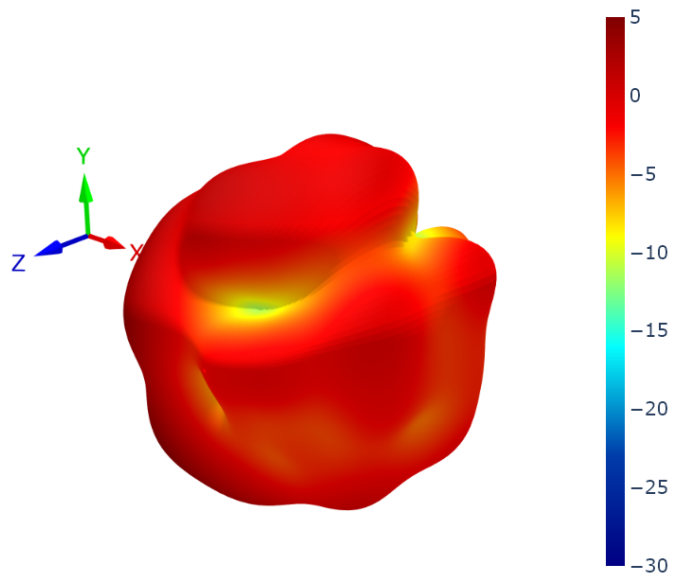

7.19 LTE1 Patterns at 2360 MHz

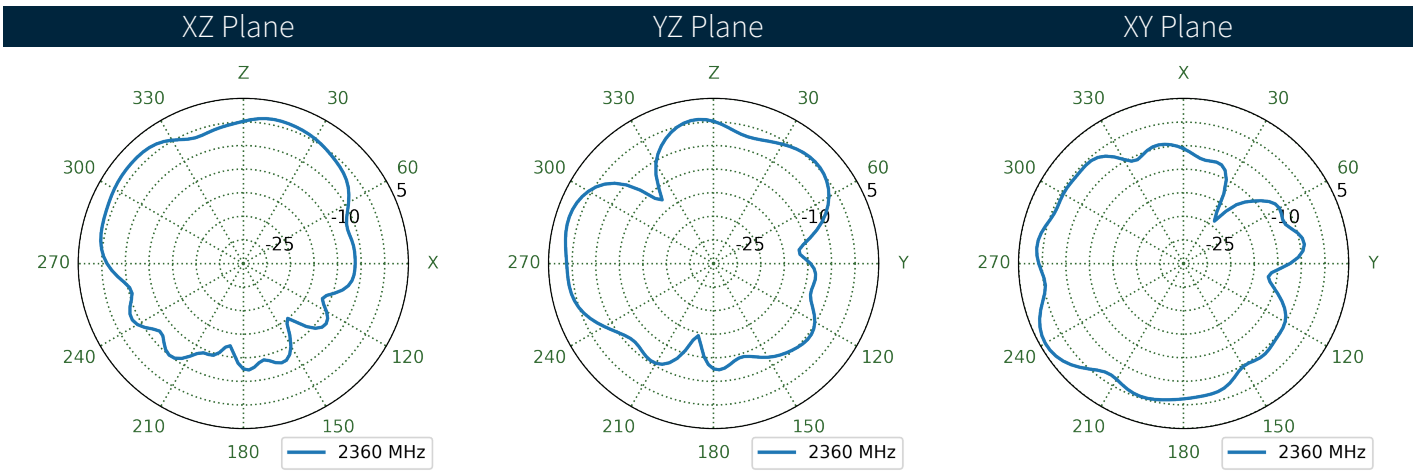
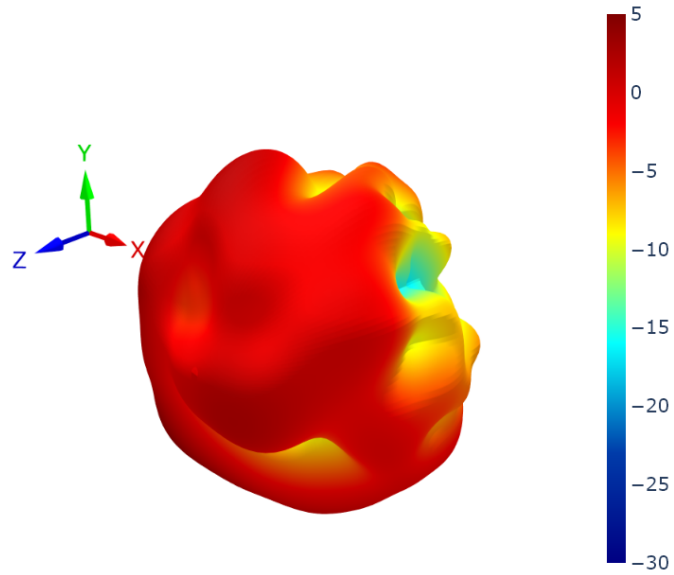

7.20 LTE2 Patterns at 2360 MHz

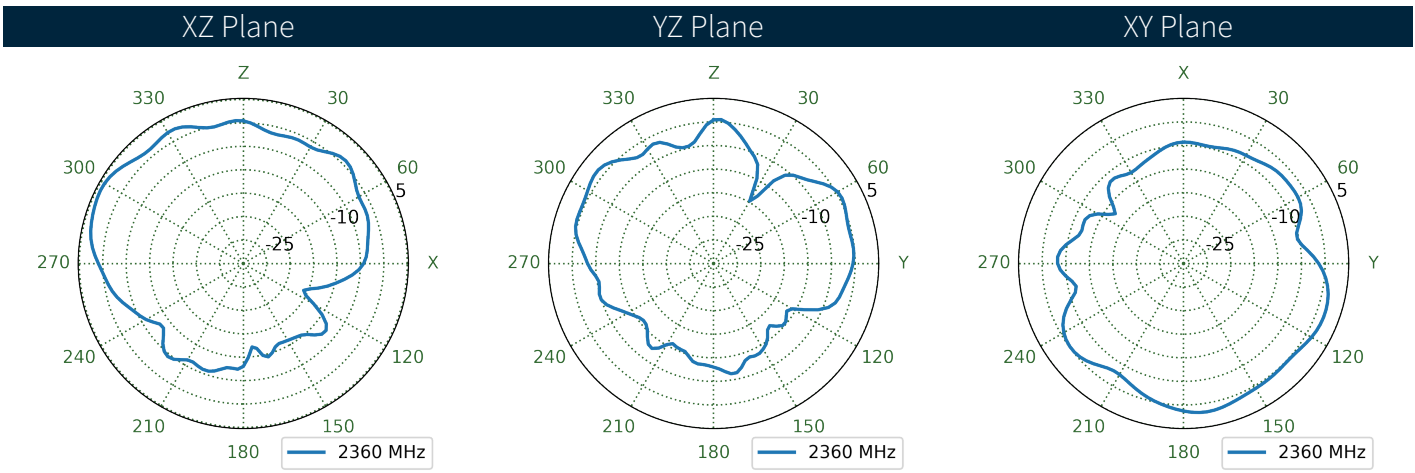
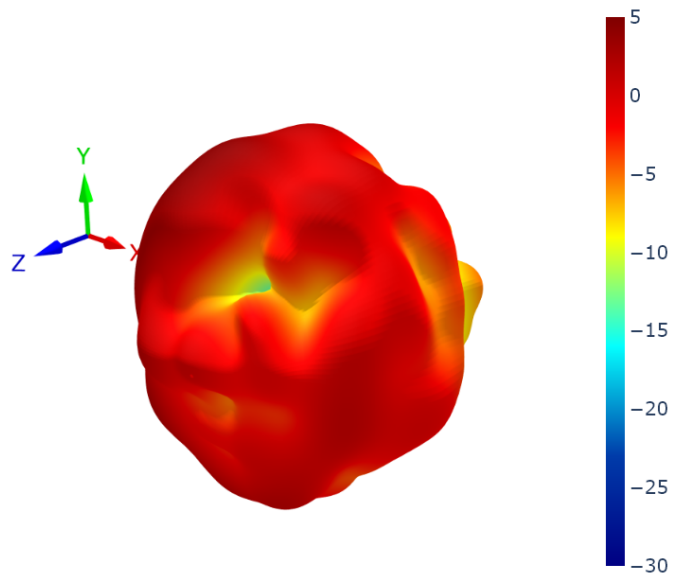

7.21 LTE1 Patterns at 2595 MHz

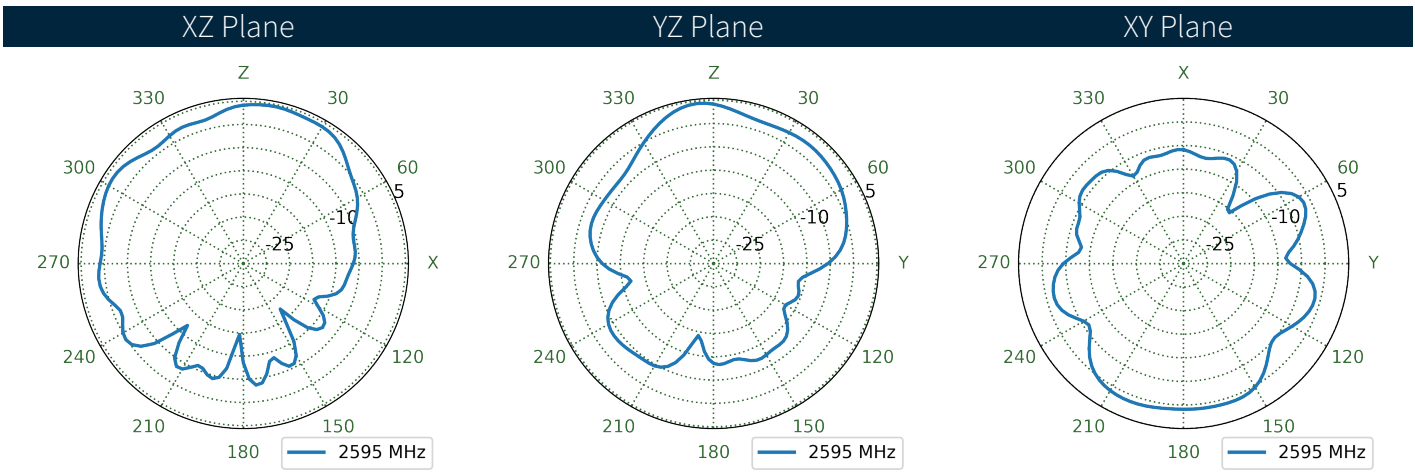
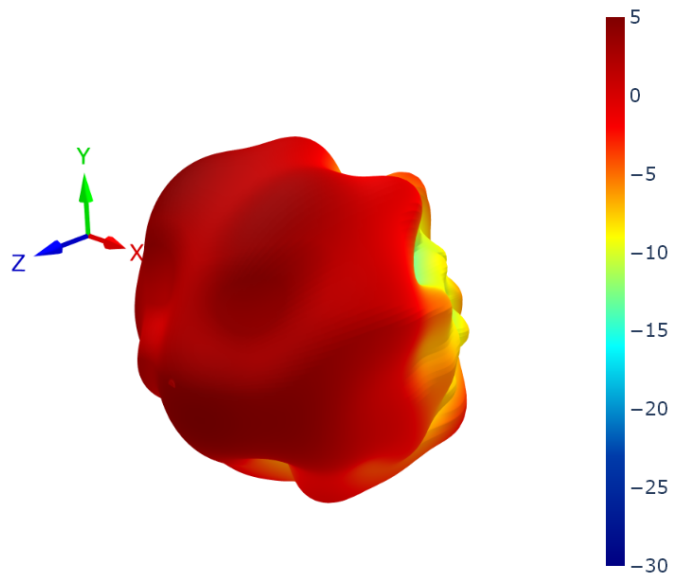

7.22 LTE2 Patterns at 2595 MHz

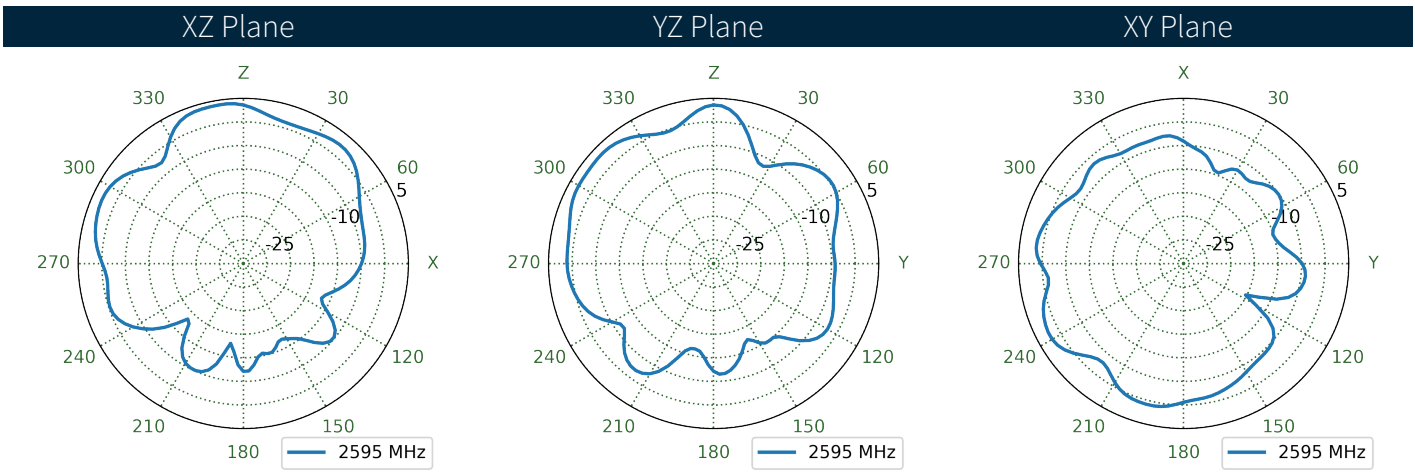
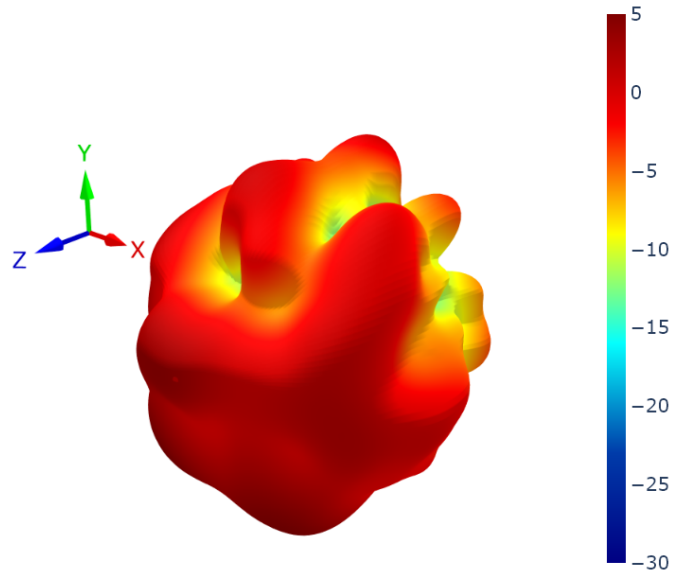

7.23 LTE1 Patterns at 3550 MHz

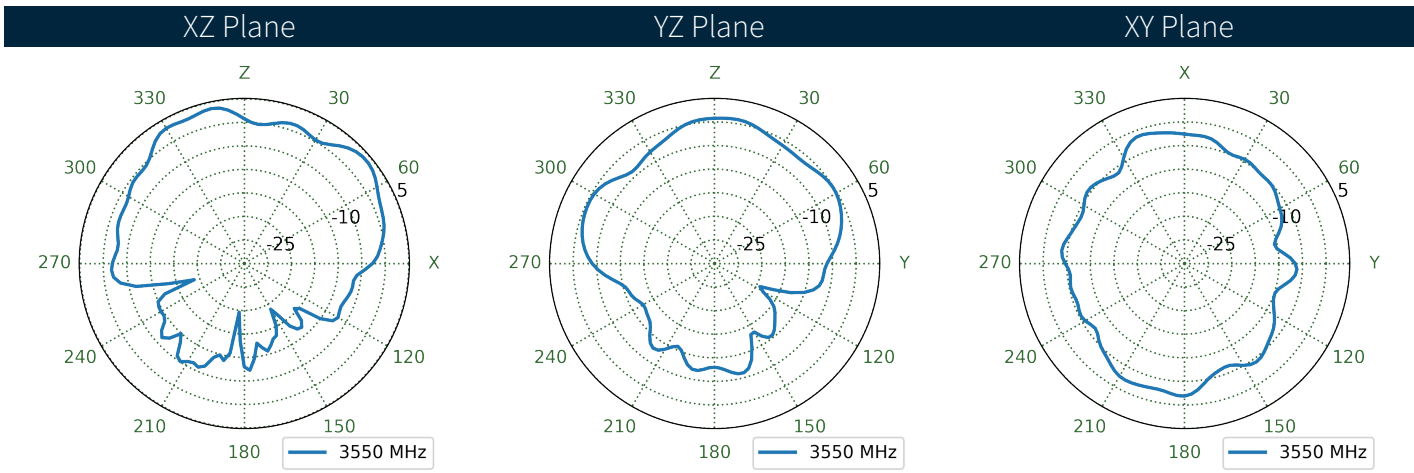
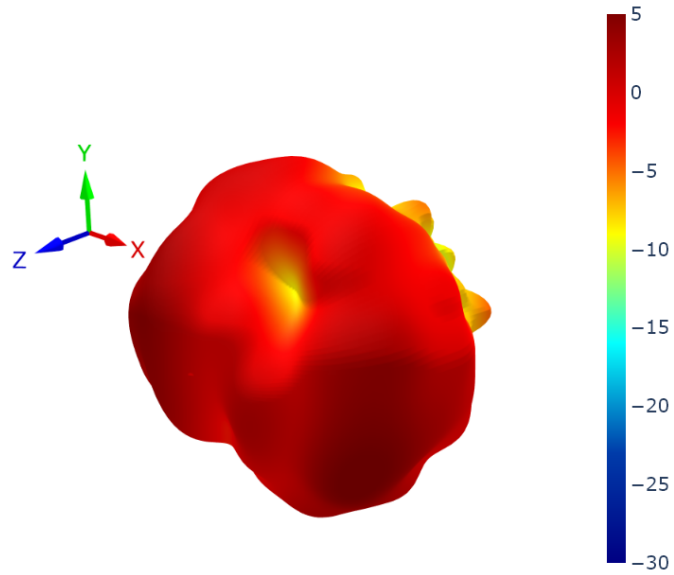

7.24 LTE2 Patterns at 3550 MHz

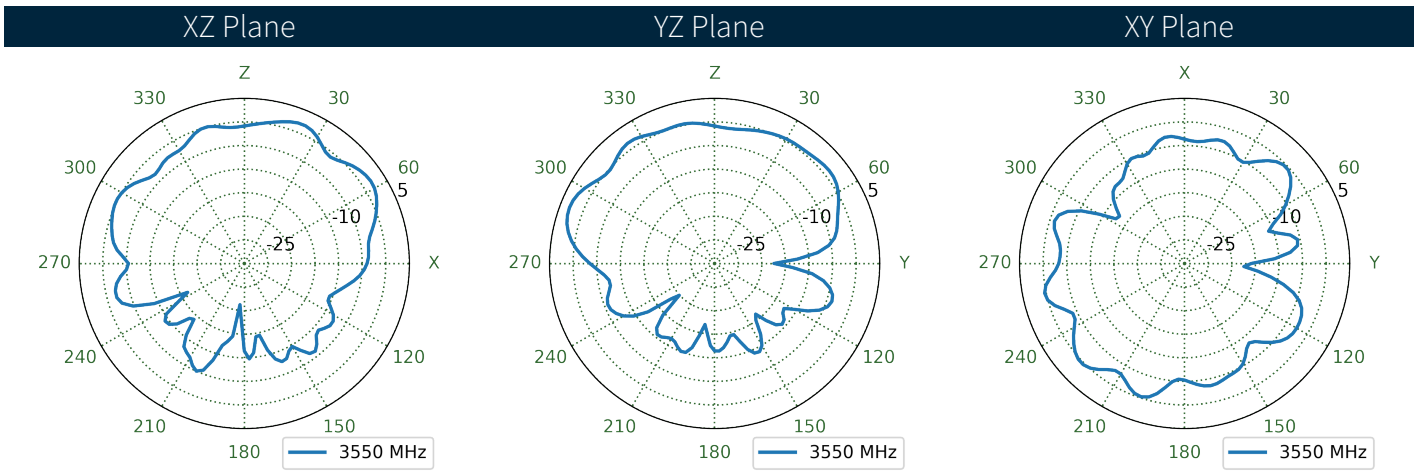
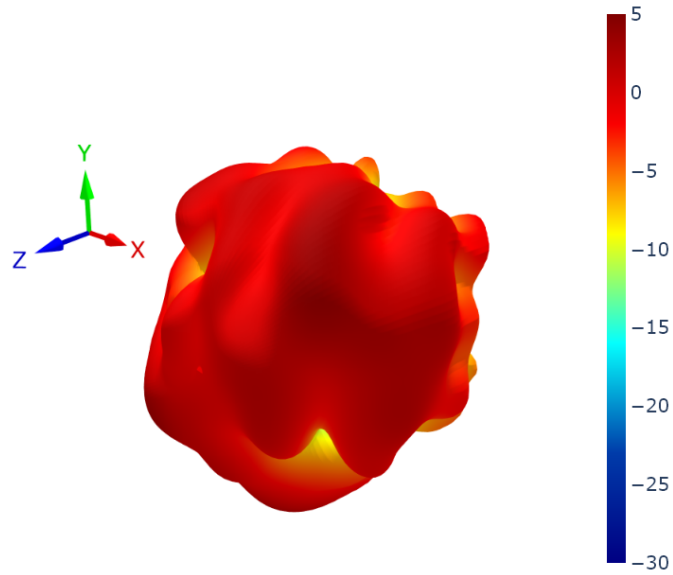



7.25 LTE1 Patterns at 4600 MHz

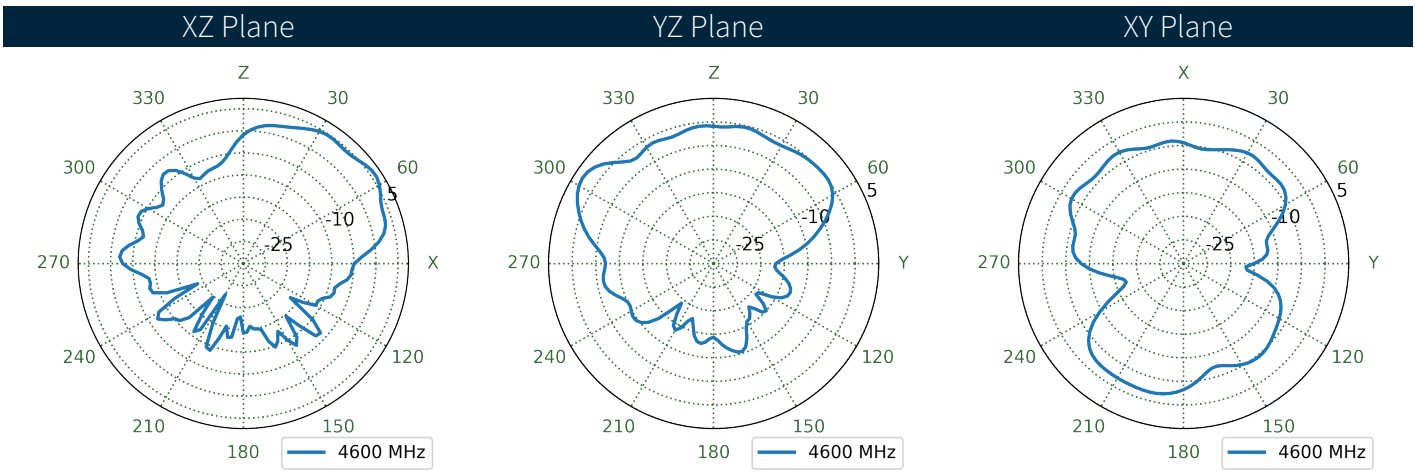
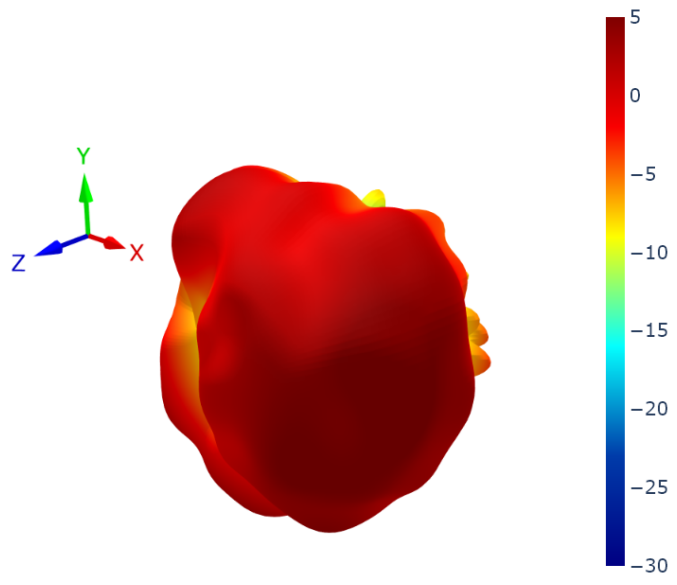

7.26 LTE2 Patterns at 4600 MHz

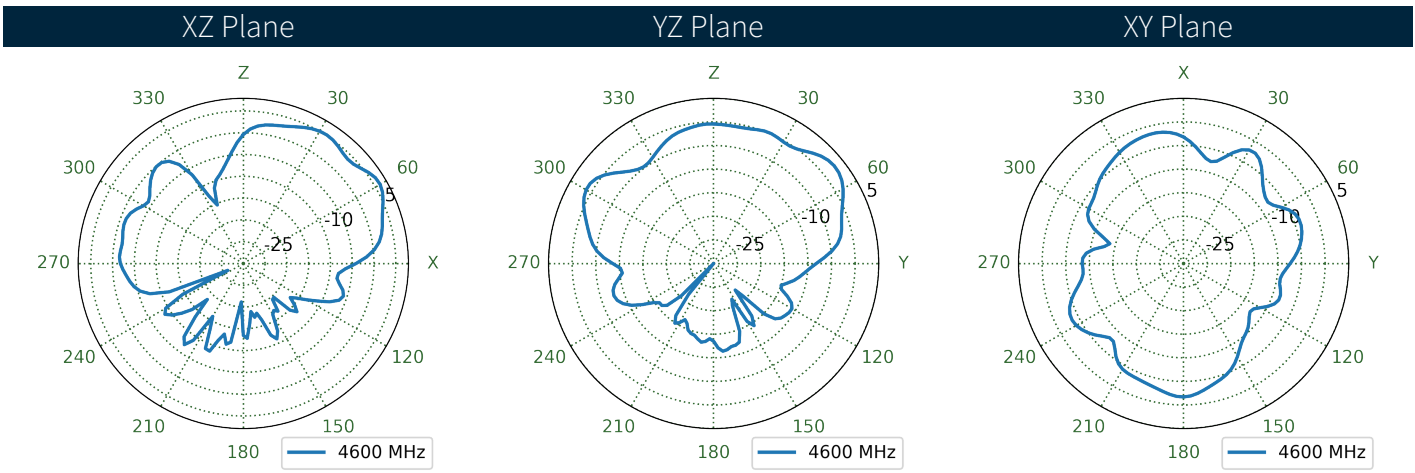
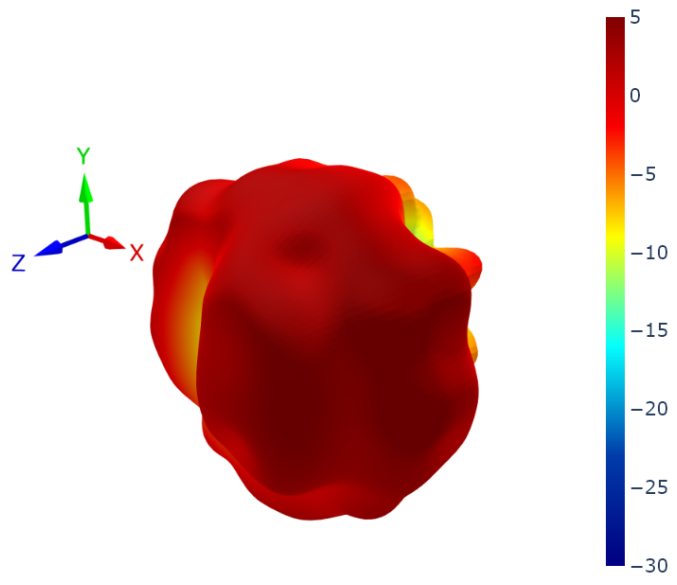

7.27 LTE1 Patterns at 4800 MHz

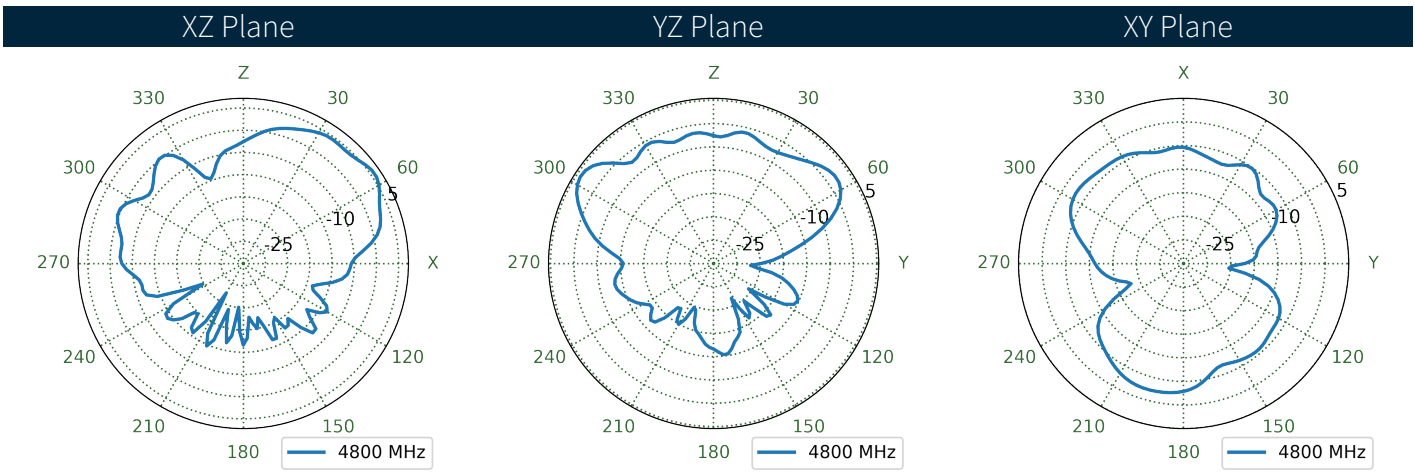
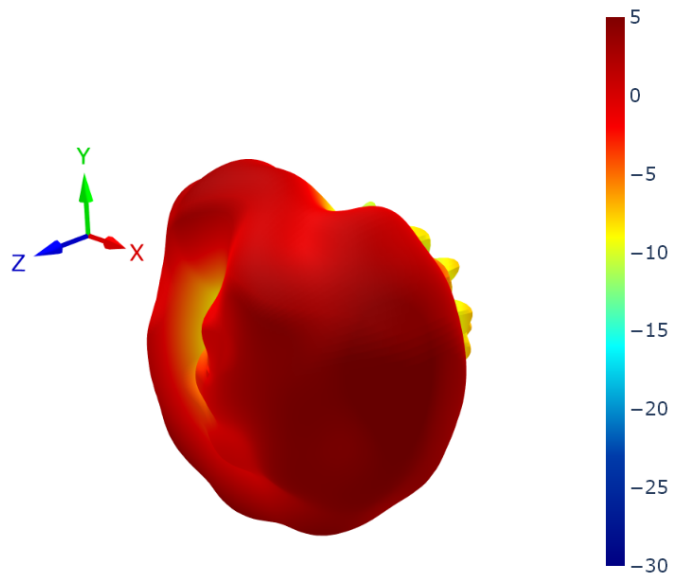

7.28 LTE2 Patterns at 4800 MHz

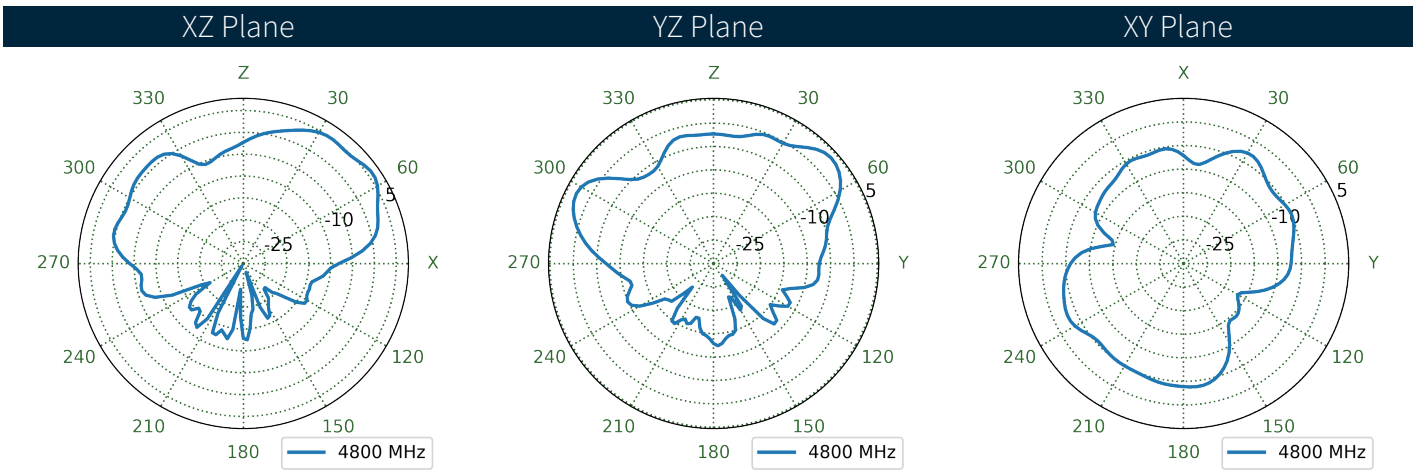
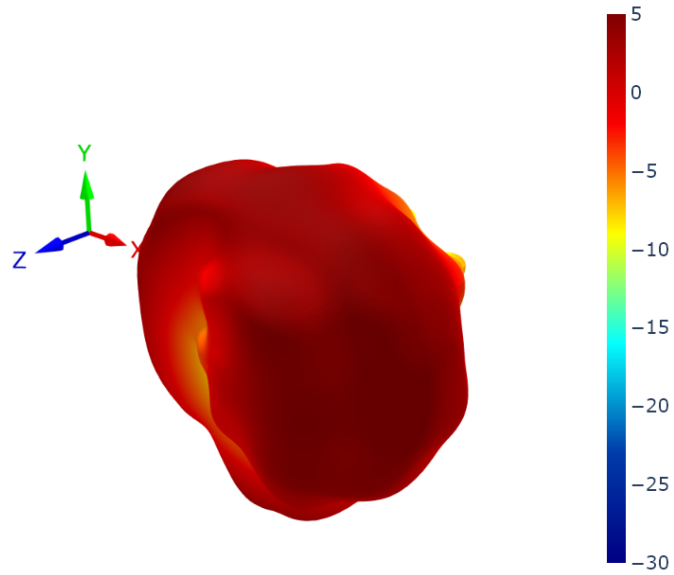

7.29 LTE1 Patterns at 5530 MHz

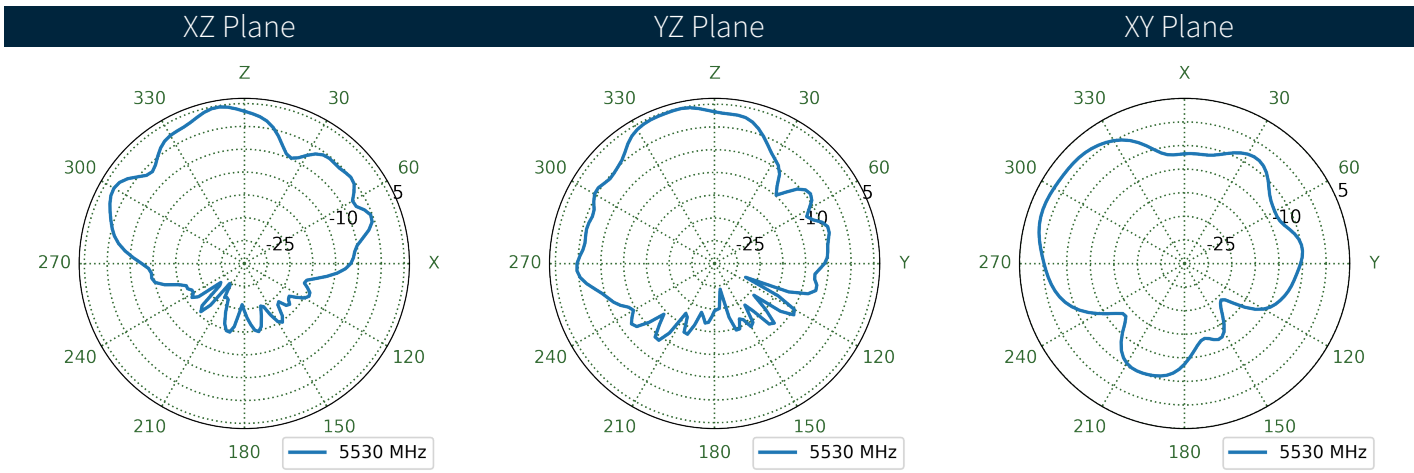
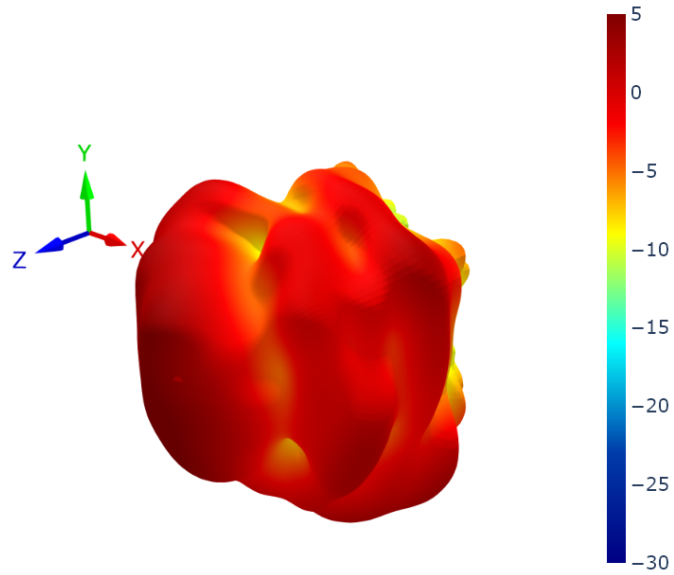

**7.30** LTE2 Patterns at 5530 MHz

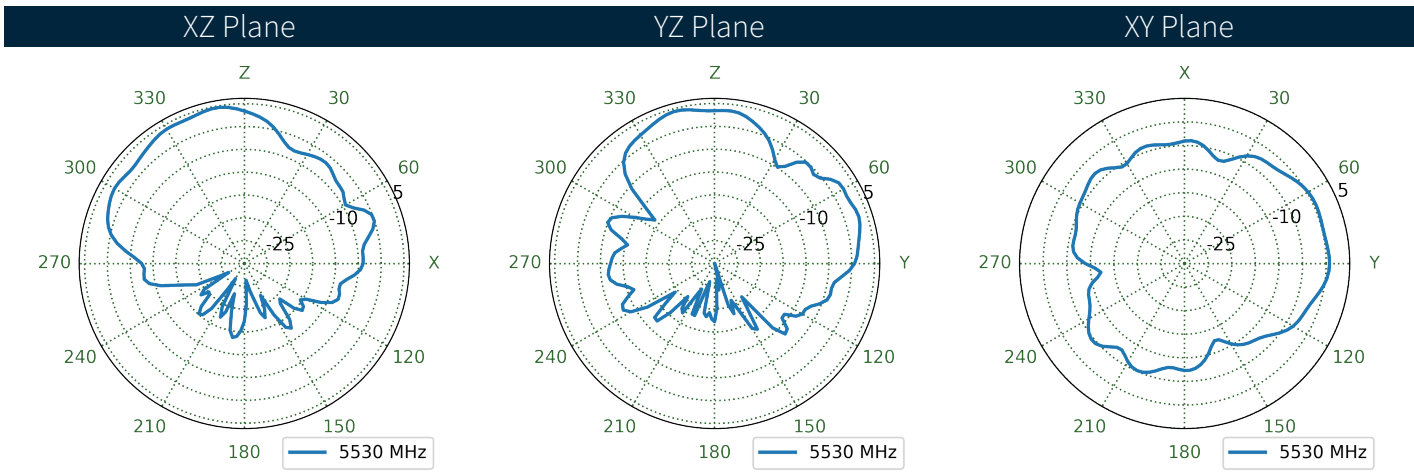
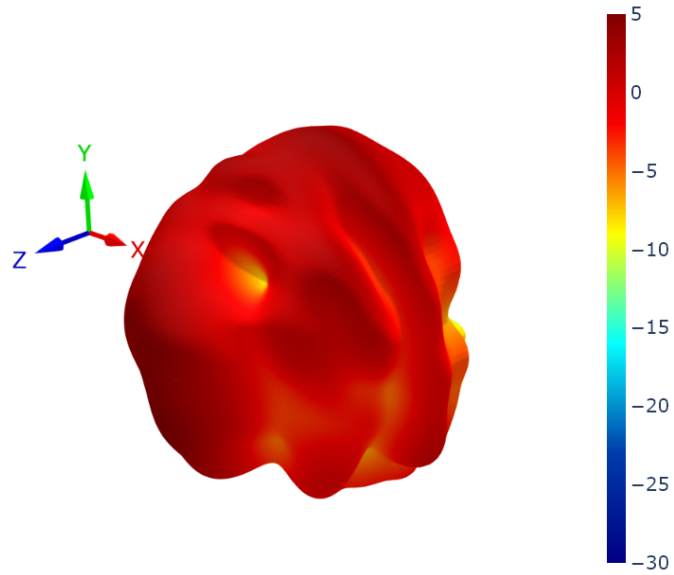

Changelog for the datasheet

**SPE-24-8-219 – MA343.W.LBI.001**

**Revision: A (Original First Release)**

Date: 2024-09-09

Notes: Initial Release

Author: Cesar Sousa

**Previous Revisions**

|  |  |
|--|--|
|  |  |
|  |  |
|  |  |
|  |  |
|  |  |





# Mouser Electronics

Authorized Distributor

Click to View Pricing, Inventory, Delivery & Lifecycle Information:

[Taoglas:](#)

[MA343.W.LBI.001](#)