



# Datasheet

## Phoenix II

**Part No:**  
GSA.8835.A.101111

### **Description:**

5G/4G I-Bar Adhesive Mount Fully IP67 Rated Low Profile Wideband Antenna

### **Features:**

5G/4G Adhesive Mount Antenna  
600-6000MHz Wideband Operation  
IP67 Rated Enclosure  
Dimensions: 105 x 30 x 7.9mm  
Connector: SMA Male Straight  
Cable: 1m of RG-174  
RoHS & REACH Compliant

1. Introduction	3
2. Specifications	4
3. Antenna Characteristics	6
4. Radiation Patterns	8
5. Mechanical Drawing	26
6. Packaging	27
<hr/>	
Changelog	28

Taoglas makes no warranties based on the accuracy or completeness of the contents of this document and reserves the right to make changes to specifications and product descriptions at any time without notice. Taoglas reserves all rights to this document and the information contained herein. Reproduction, use or disclosure to third parties without express permission is strictly prohibited.



## 1. Introduction



The Taoglas GSA.8835 is a fully IP67 rated waterproof 5G/4G external adhesive mount antenna designed for use with all Cellular modules worldwide including new 5G bands. The GSA.8835 has been designed as a fully IP67 waterproof rated enclosure and with extended wideband cellular frequency range coverage of 600-6000MHz, the newly designed GSA.8835 is ready for use at all cellular bands across 5G/4G/3G/2G.

Typical Applications Include:

- Transportation
- Agriculture
- Autonomous Vehicles/Robotics

Providing excellent efficiency and gain, this low profile(7.9mm) antenna is ideal in areas where space is at a premium. The Phoenix II is fully IP67 rated, making it an ideal solution for outdoor applications. The GSA.8835 can be mounted on glass or plastic and comes with a strong 3M 1600T adhesive already adhered to the bottom side of the antenna for ease of installation.

The Cable length and connector type is fully customizable, for more information or installation instructions, please contact your regional Taoglas Customer Support Team.

## 2. Specifications

Electrical								
Band	Frequency (MHz)	Efficiency (%)	Average Gain (dB)	Peak Gain (dBi)	Impedance	Max Input Power	Polarization	Radiation Pattern
<b>5G NR/4G</b> Band 71	617~698	38.9	-4.3	1.1	50 Ω	1W	Linear	Omni
<b>4G/3G</b> Band 12,13,14,17,28,29	698~806	56.6	-2.5	1.7				
<b>4G/3G</b> Band 5,8,18,19,20,26,27	824~960	62.1	-2.1	1.2				
<b>5G NR/4G</b> Band 21,32,74,75,76	1427~1518	69.9	-1.6	3.5				
<b>4G/3G</b> Band 1,2,3,4,9,23,25,35,39,66	1710~2200	60.5	-2.2	2.9				
<b>4G/3G</b> Band 7,38,41	2490~2690	44.1	-3.6	2.1				
<b>5G NR/4G</b> Band 22,42,48,77,78	3300~3500	37.3	-4.3	2				
<b>LTE5200/ Wi-Fi 5800</b>	5150~5925	27.5	-5.6	-1				

Mechanical	
Dimensions	30*105*7.9mm
Casing	PC+ABS
Cable	RG-174, 1000mm
Connector	SMA Male Straight
Adhesive	3M 1600T
Weight	35g

Environmental	
Ingress Protection	IP67
Temperature Range	-40°C to 85°C
Humidity	Non-condensing 65°C 95% RH
Shock (Drop Test)	1m drop on concrete 6 axes
Cable Pull	8kgf

5G/4G Bands			
Band Number	5G NR / FR1 / LTE / LTE-Advanced / WCDMA / HSPA / HSPA+ / TD-SCDMA		
	Uplink	Downlink	Covered
1	UL: 1920 to 1980	DL: 2110 to 2170	✓
2	UL: 1850 to 1910	DL: 1930 to 1990	✓
3	UL: 1710 to 1785	DL: 1805 to 1880	✓
4	UL: 1710 to 1755	DL: 2110 to 2155	✓
5	UL: 824 to 849	DL: 869 to 894	✓
7	UL: 2500 to 2570	DL: 2620 to 2690	✓
8	UL: 880 to 915	DL: 925 to 960	✓
9	UL: 1749.9 to 1784.9	DL: 1844.9 to 1879.9	✓
11	UL: 1427.9 to 1447.9	DL: 1475.9 to 1495.9	✓
12	UL: 699 to 716	DL: 729 to 746	✓
13	UL: 777 to 787	DL: 746 to 756	✓
14	UL: 788 to 798	DL: 758 to 768	✓
17	UL: 704 to 716	DL: 734 to 746	✓
18	UL: 815 to 830	DL: 860 to 875	✓
19	UL: 830 to 845	DL: 875 to 890	✓
20	UL: 832 to 862	DL: 791 to 821	✓
21	UL: 1447.9 to 1462.9	DL: 1495.9 to 1510.9	✓
22	UL: 3410 to 3490	DL: 3510 to 3590	✓
23	UL: 2000 to 2020	DL: 2180 to 2200	✓
24	UL: 1625.5 to 1660.5	DL: 1525 to 1559	✓
25	UL: 1850 to 1915	DL: 1930 to 1995	✓
26	UL: 814 to 849	DL: 859 to 894	✓
27	UL: 807 to 824	DL: 852 to 869	✓
28	UL: 703 to 748	DL: 758 to 803	✓
29	UL: -	DL: 717 to 728	✓
30	UL: 2305 to 2315	DL: 2350 to 2360	✓
31	UL: 452.5 to 457.5	DL: 462.5 to 467.5	✗
32	UL: -	DL: 1452 - 1496	✓
35		1850 to 1910	✓
38		2570 to 2620	✓
39		1880 to 1920	✓
40		2300 to 2400	✓
41		2496 to 2690	✓
42		3400 to 3600	✓
43		3600 to 3800	✗
48		3550 to 3700	✓
66	UL: 1710-1780	DL: 2110-2200	✓
71		617 to 698	✓
74/75/76		1427 to 1518	✓
77		3300 to 4200	✓
78		3300 to 3800	✓
79		4400 to 5000	✓

\* Covered Bands represent at least 20% efficiency

### 3. Antenna Characteristics

#### 3.1 Return Loss

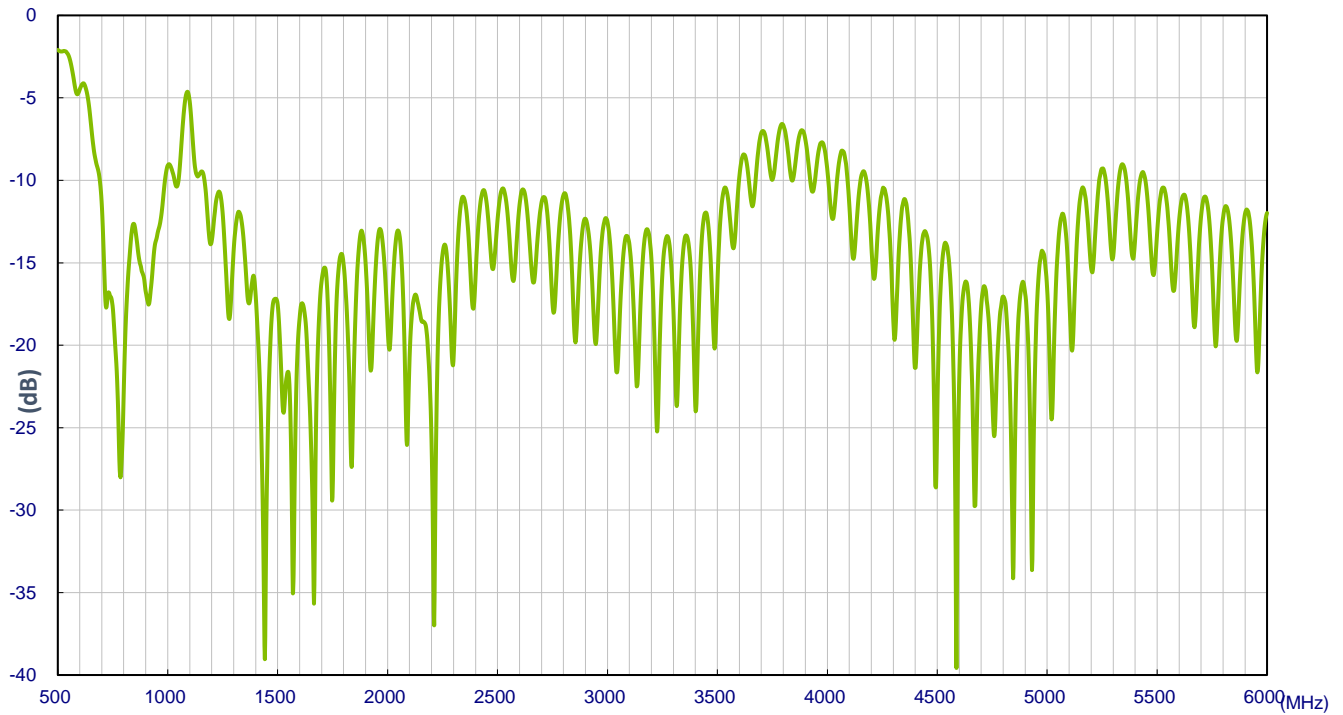

#### 3.2 Efficiency

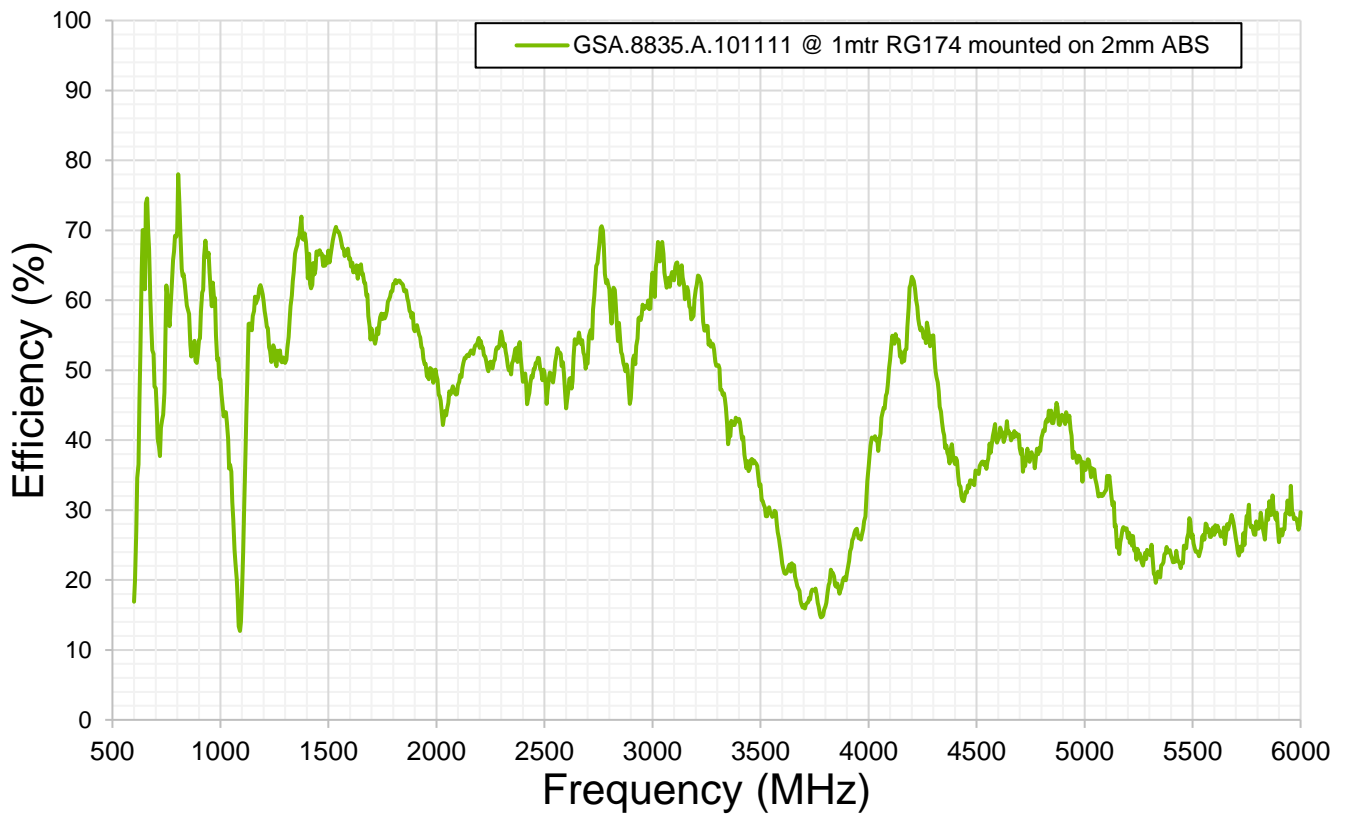

### 3.3 Average Gain

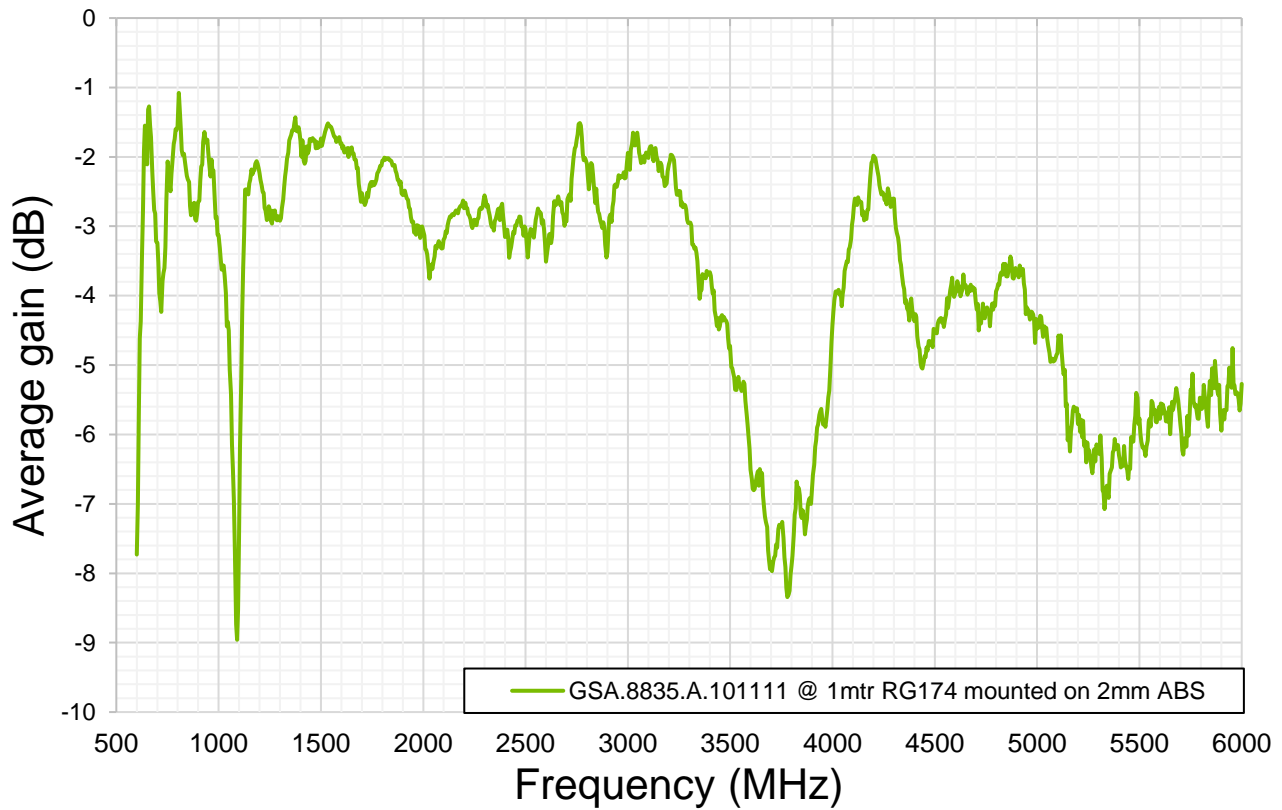

### 3.4 Peak Gain

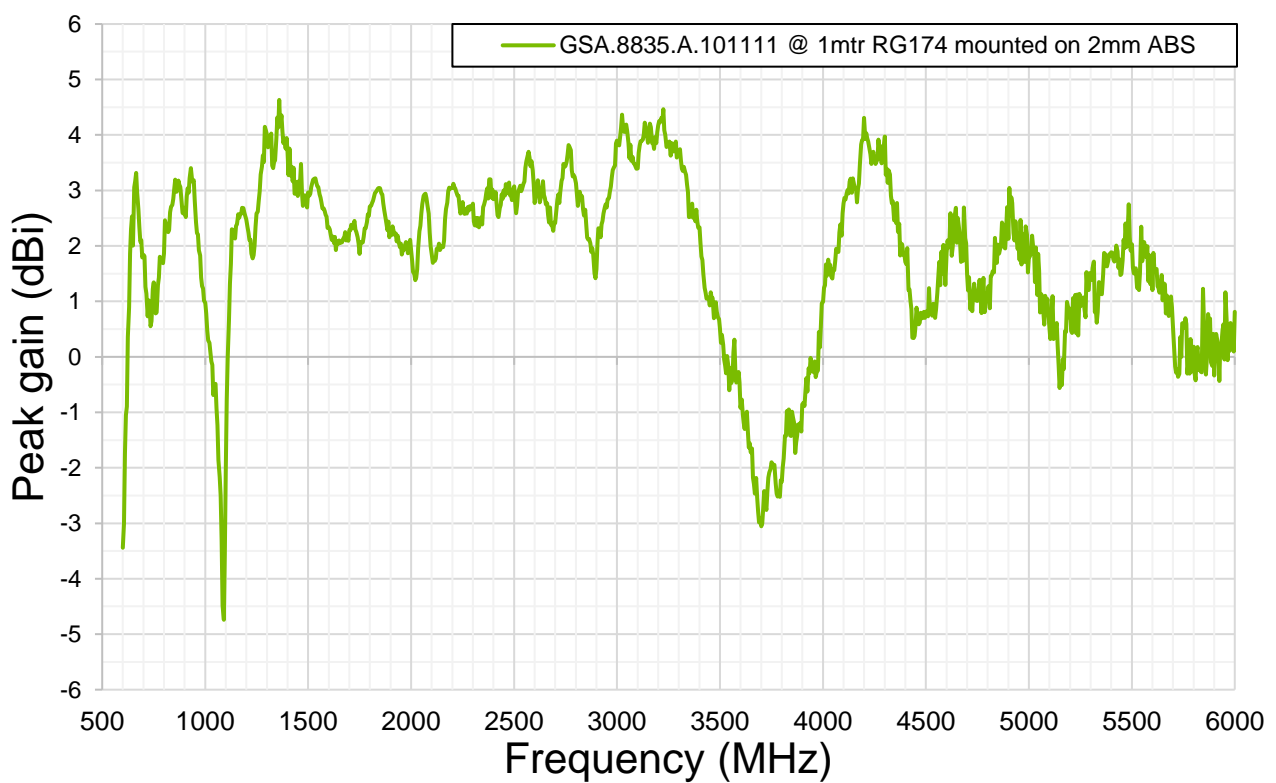

## 4. Radiation Patterns

### 4.1 Test Setup



Free space



4.2 3D and 2D Radiation Patterns

617MHz

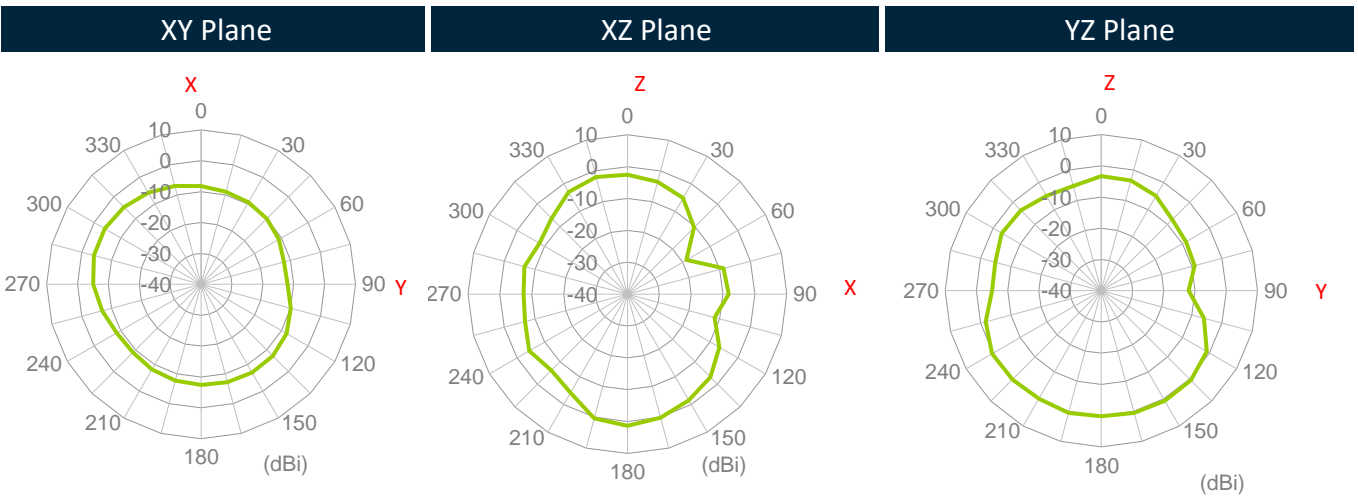
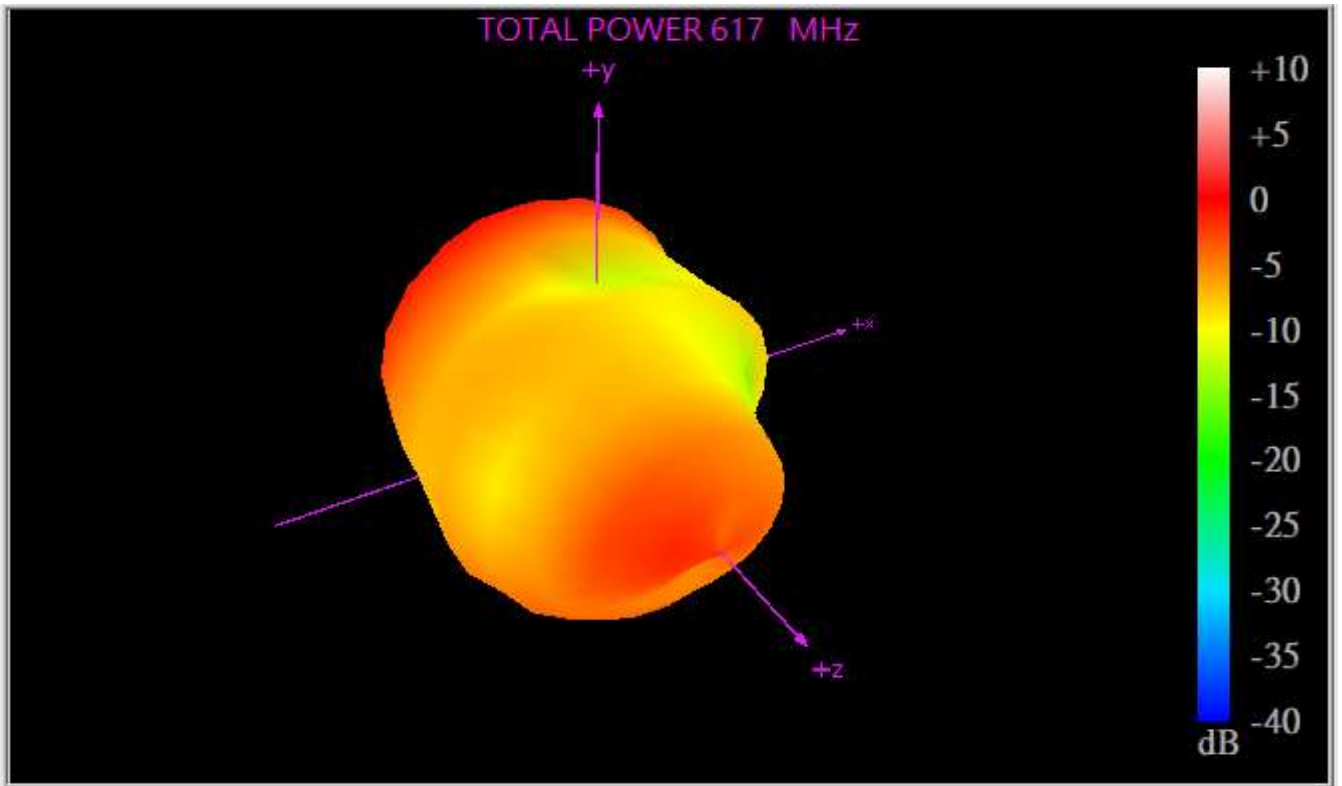

704MHz

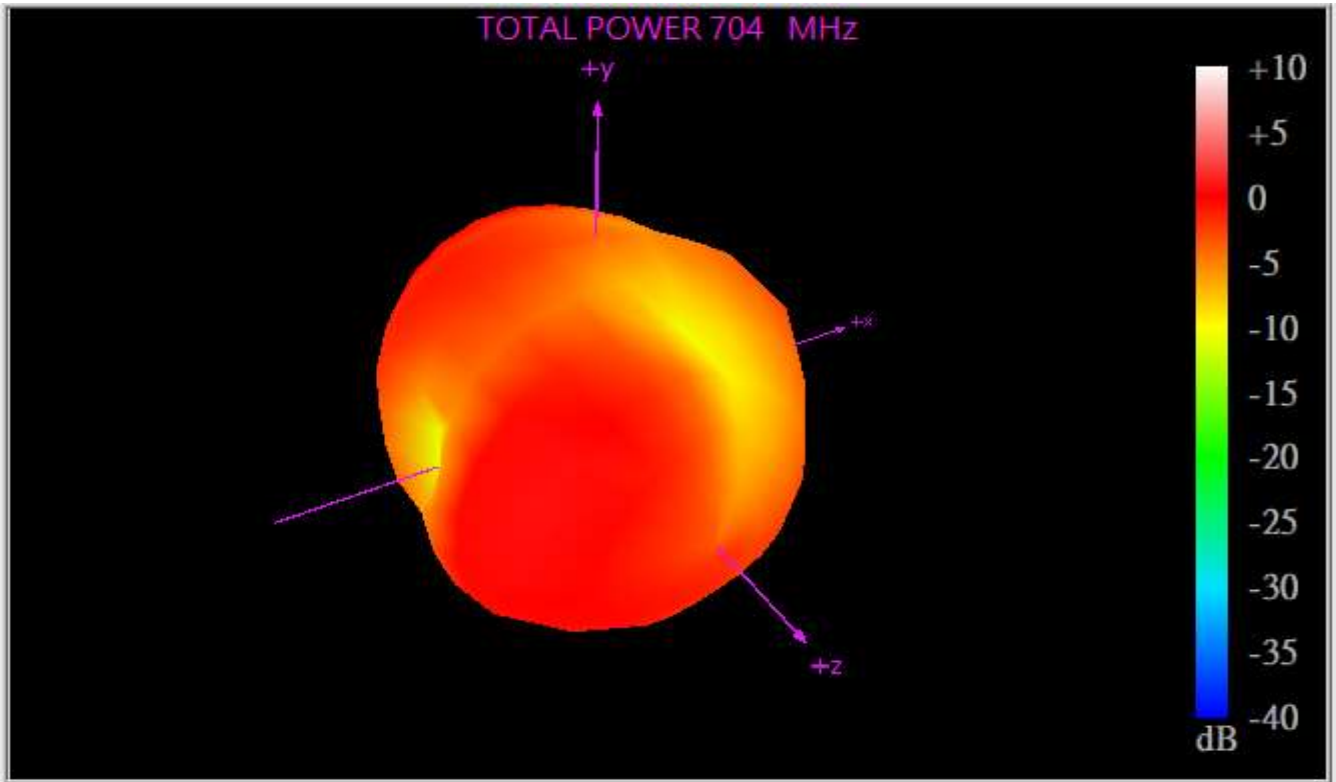

XY Plane

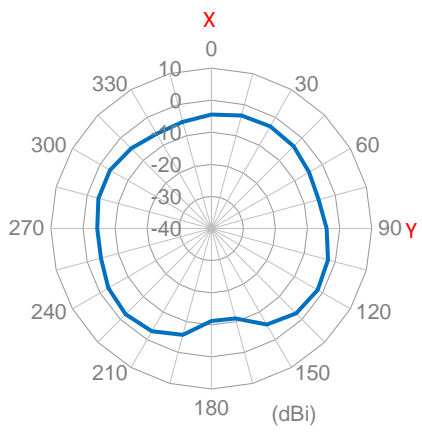

XZ Plane

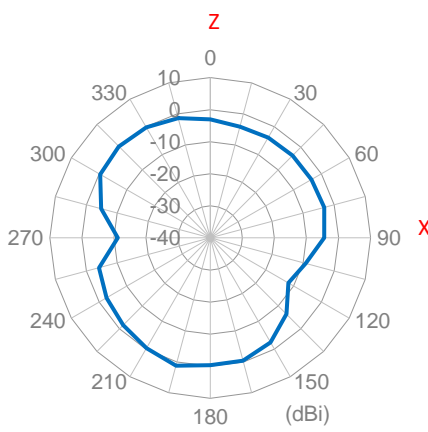

YZ Plane

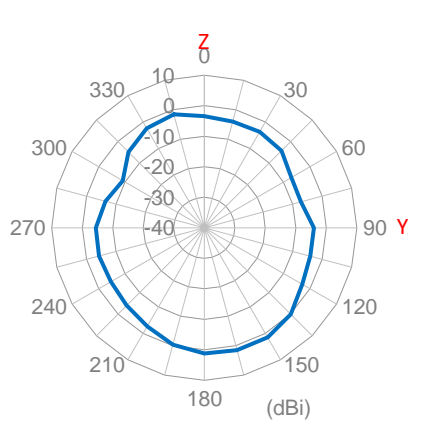

751MHz

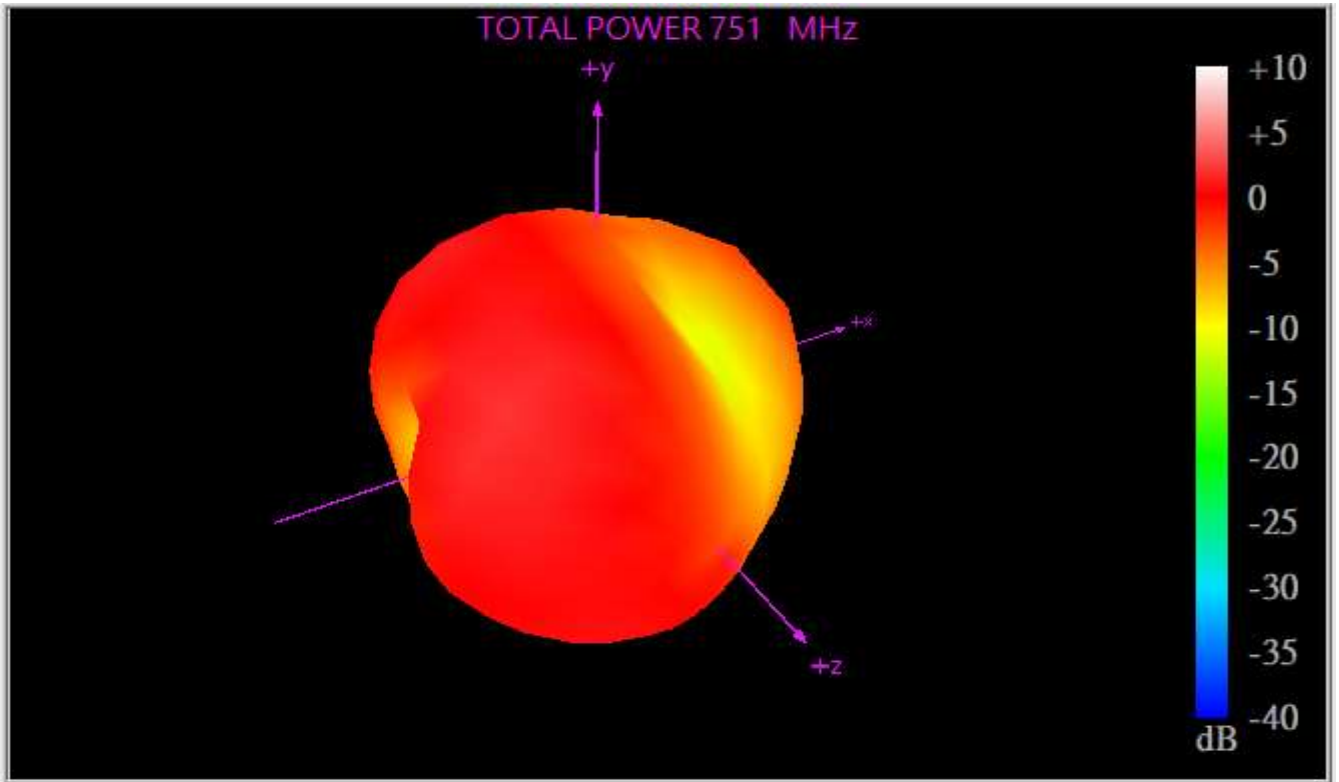

XY Plane

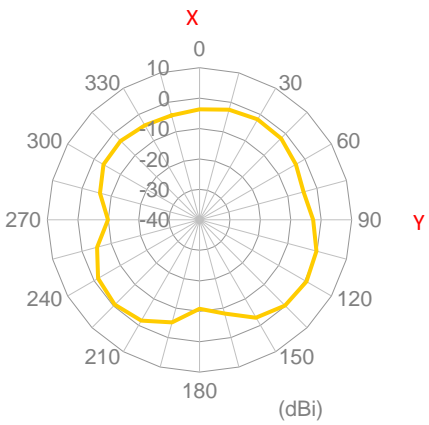

XZ Plane

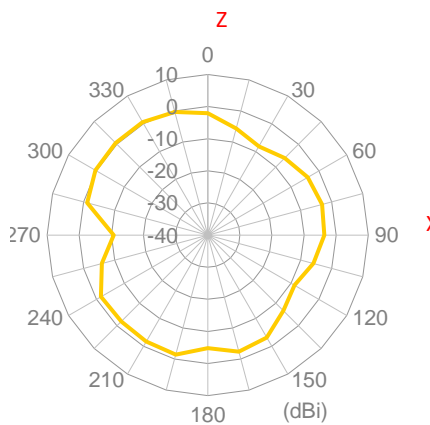

YZ Plane

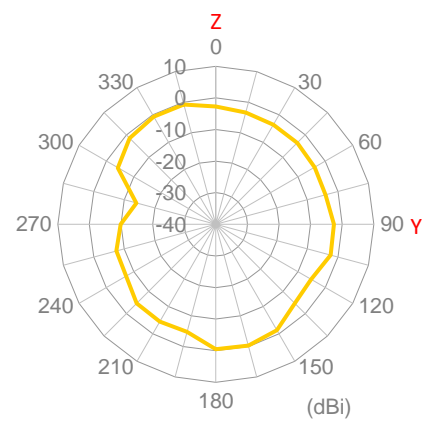

824MHz

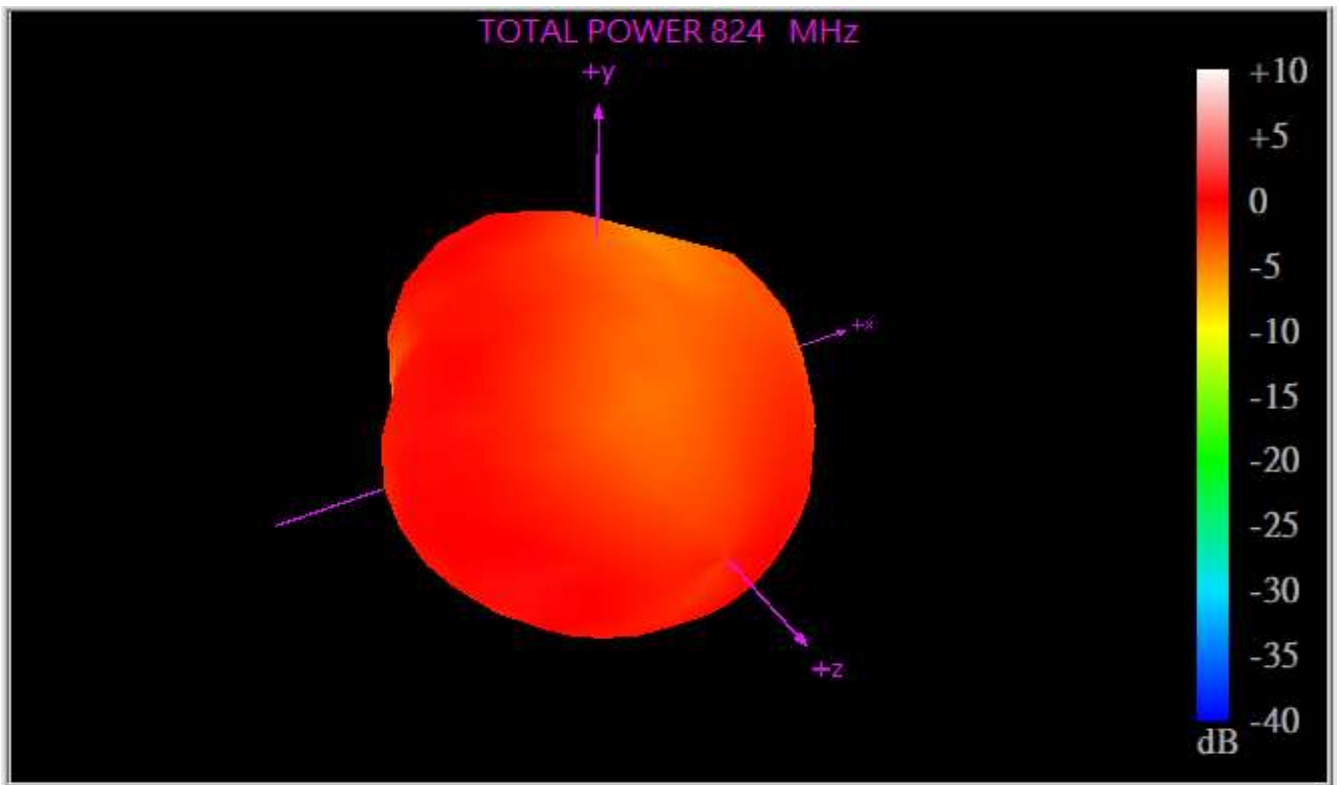

XY Plane

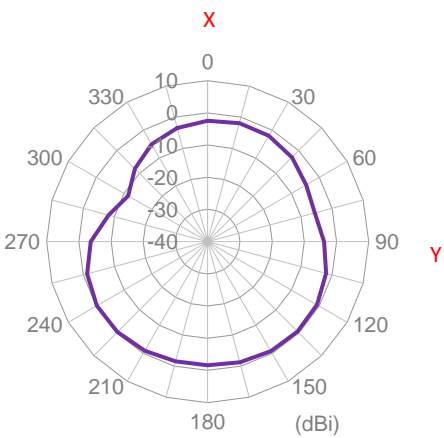

XZ Plane

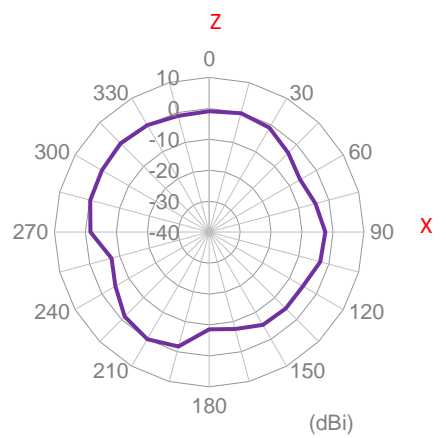

YZ Plane

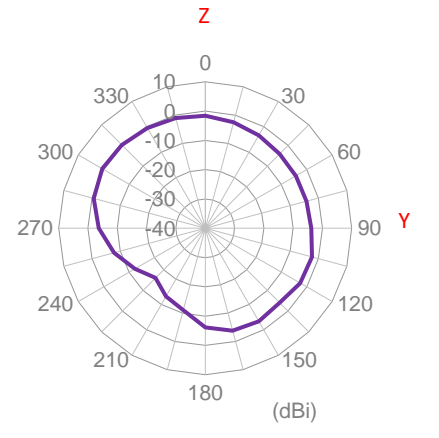

960MHz

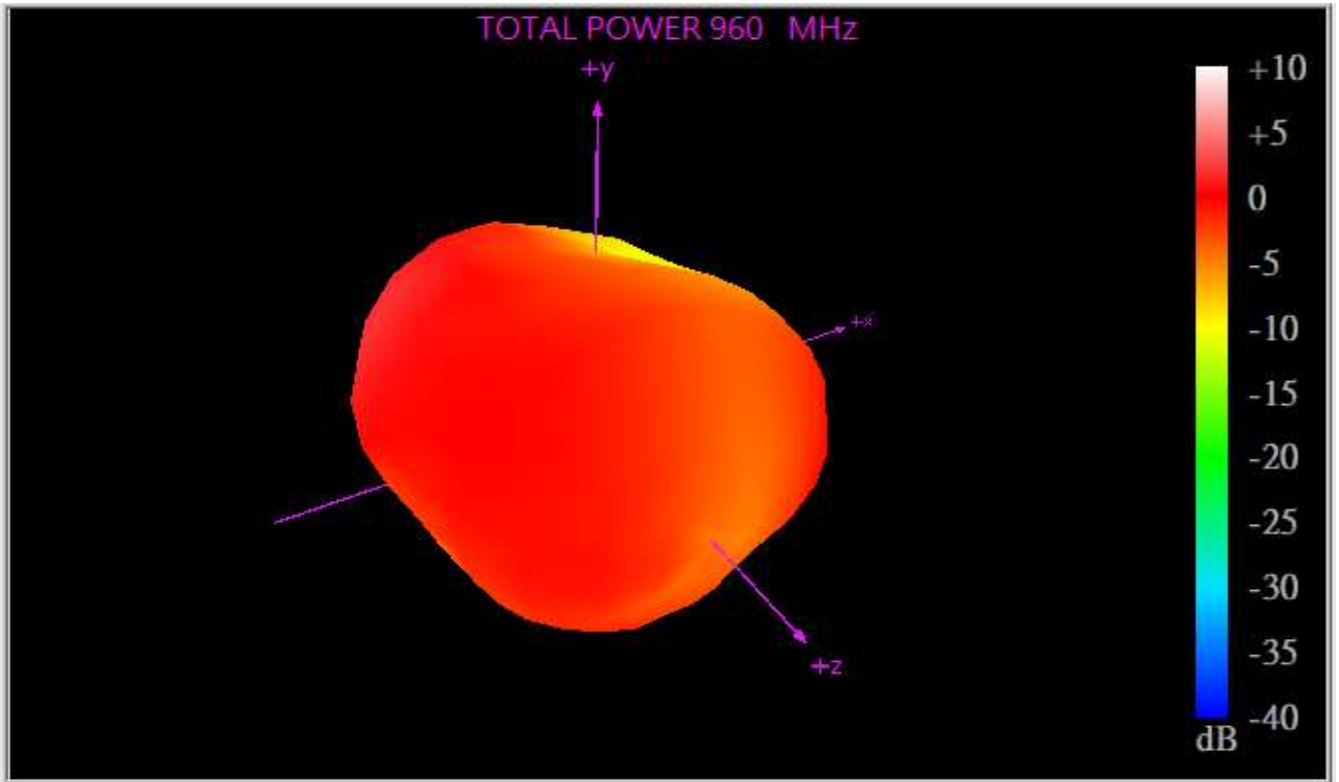

XY Plane

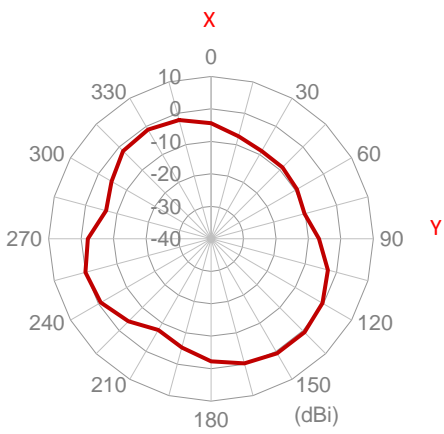

XZ Plane

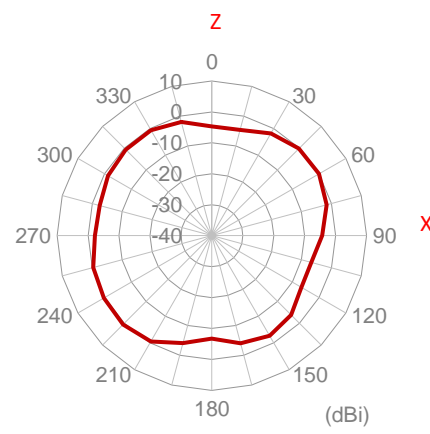

YZ Plane

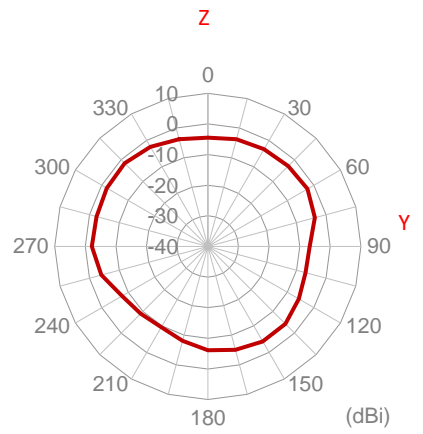

1710MHz

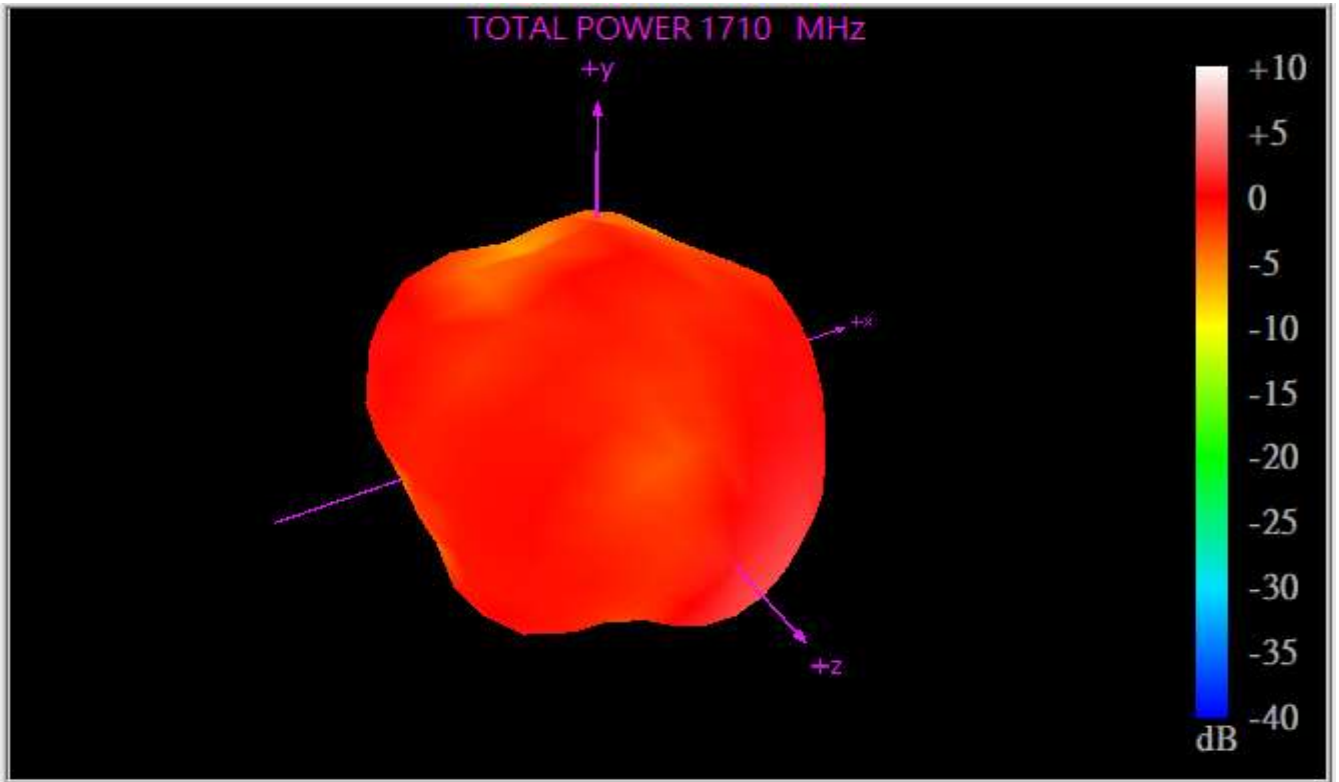

XY Plane

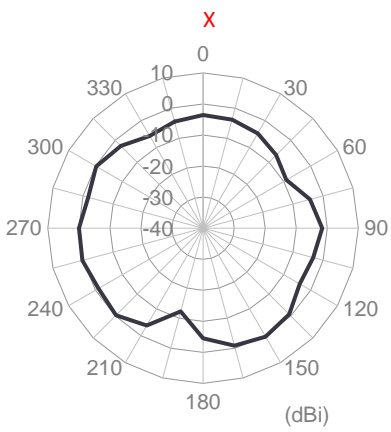

XZ Plane

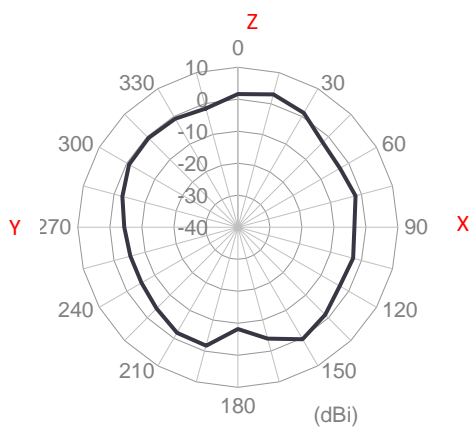

YZ Plane

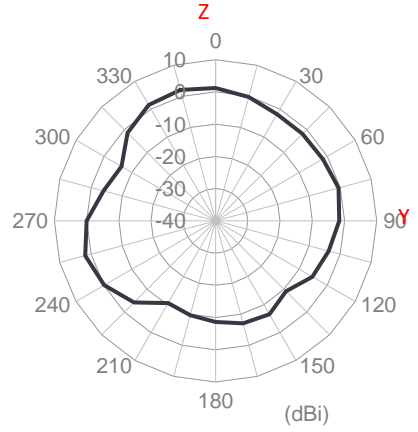

1850MHz

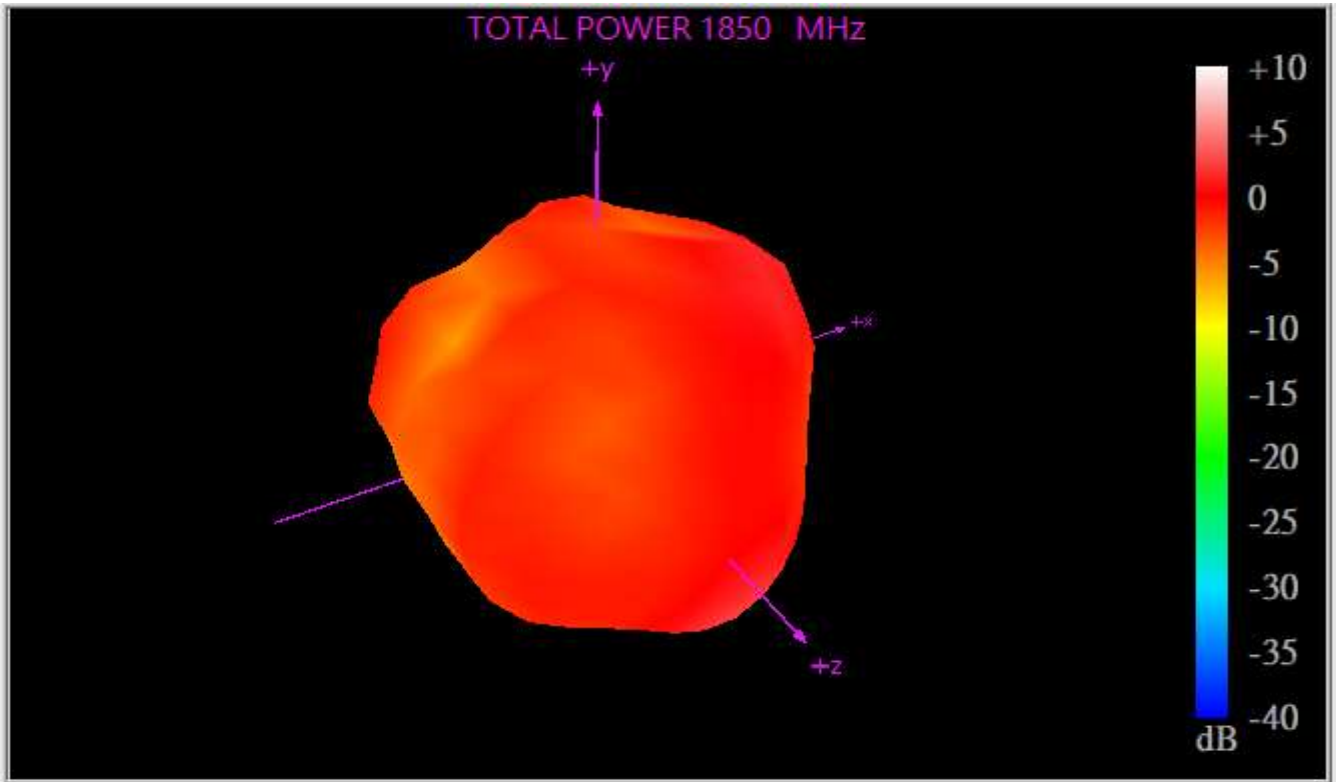

XY Plane

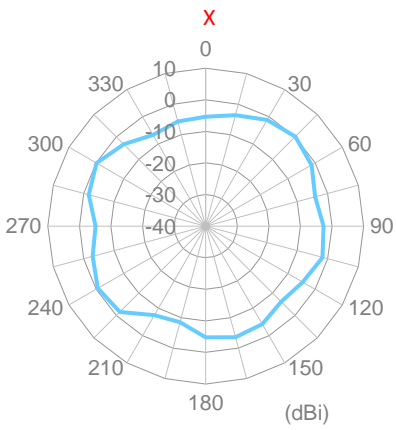

XZ Plane

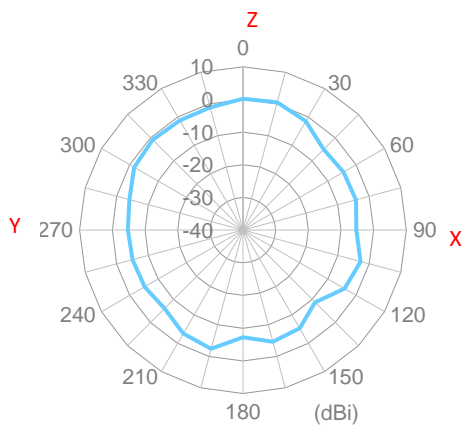

YZ Plane

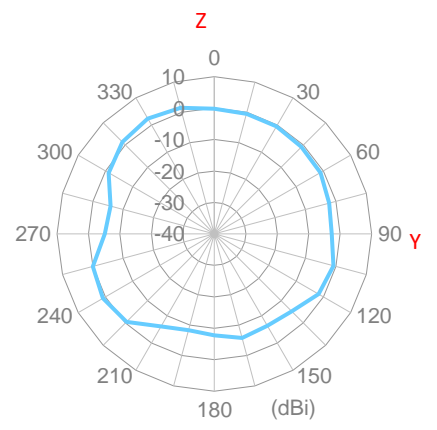

1990MHz

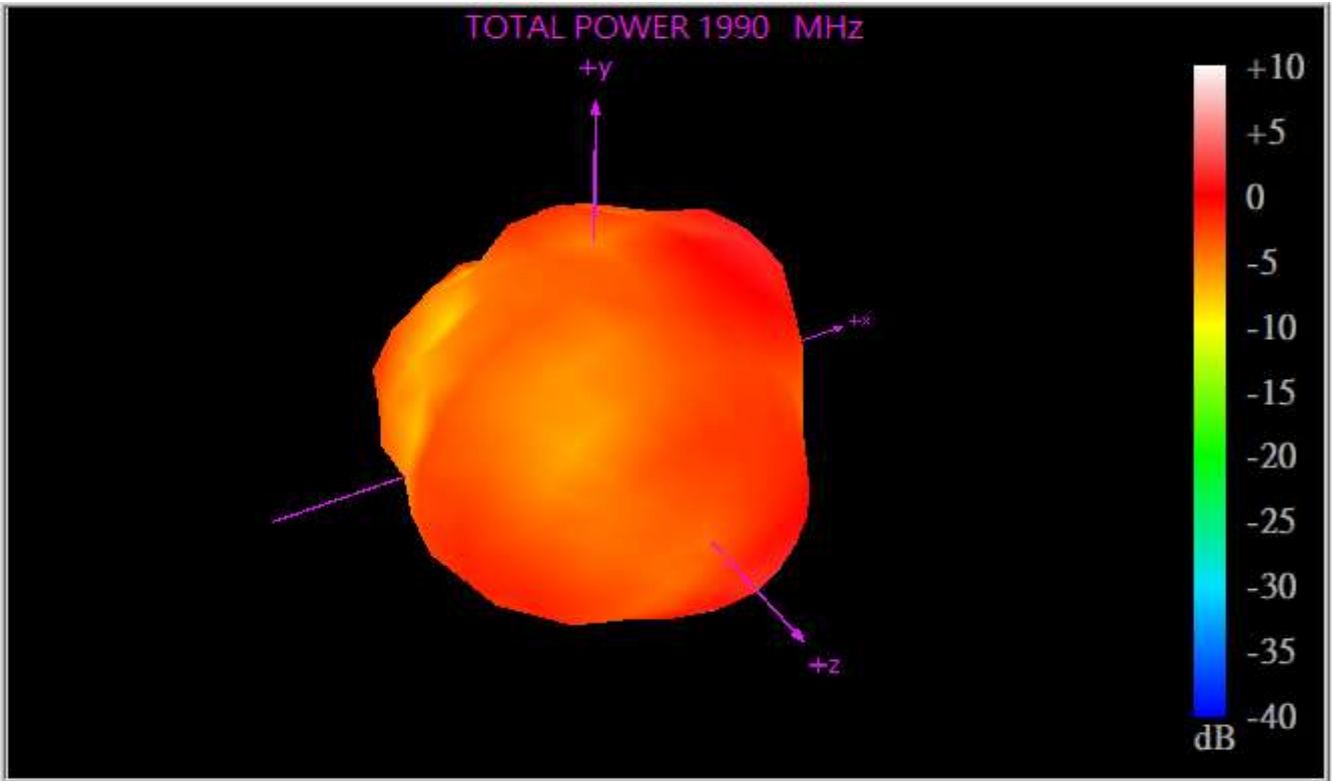

XY Plane

XZ Plane

YZ Plane

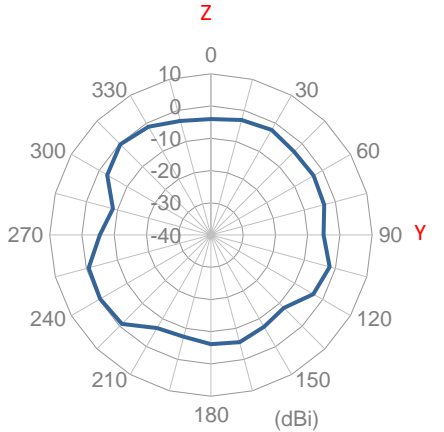
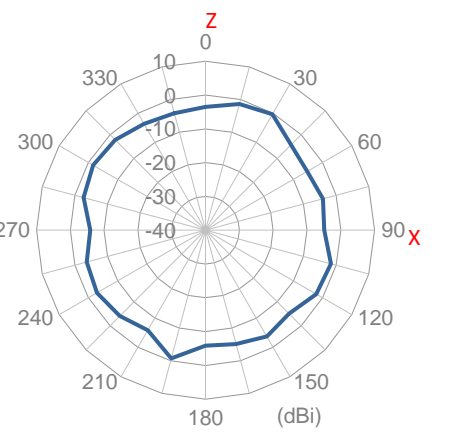
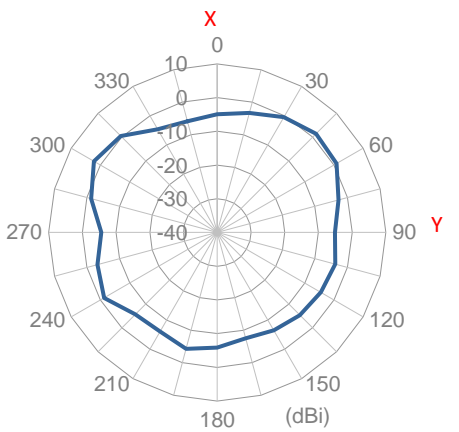



2170MHz

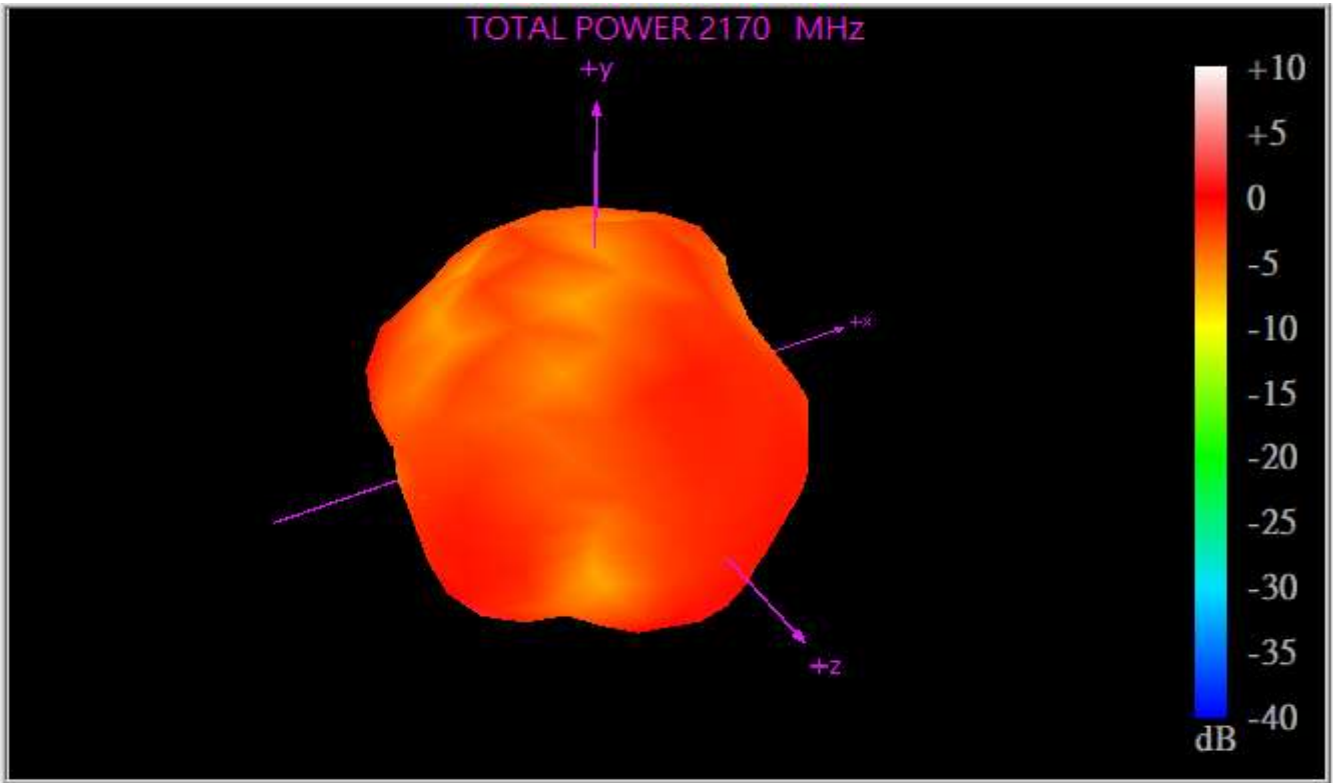

XY Plane

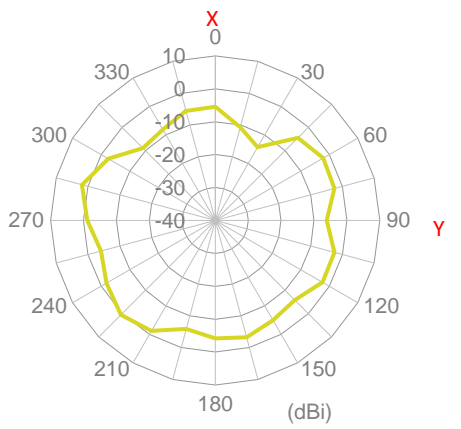

XZ Plane

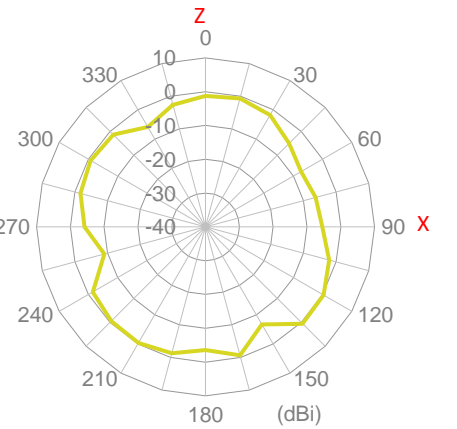

YZ Plane

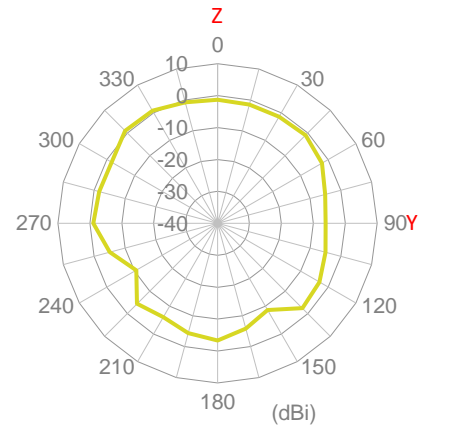

2500MHz

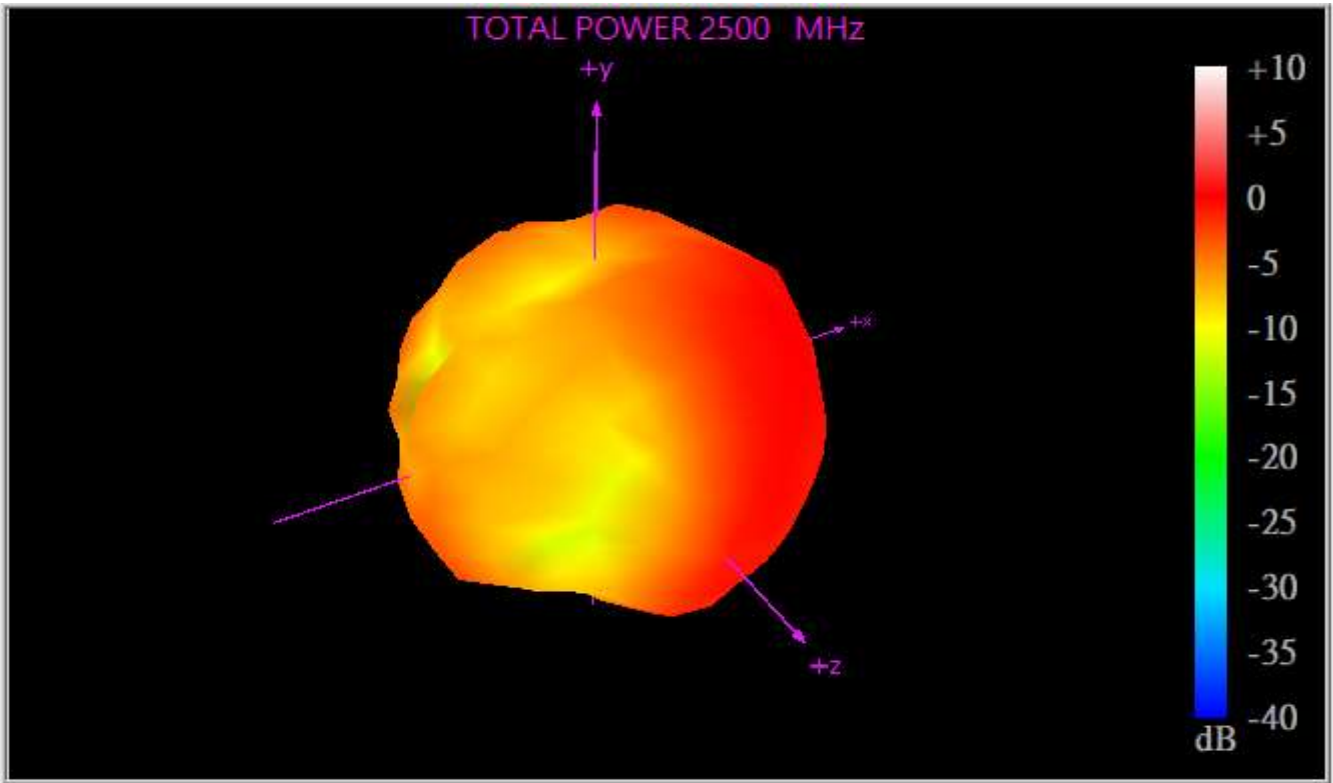

XY Plane

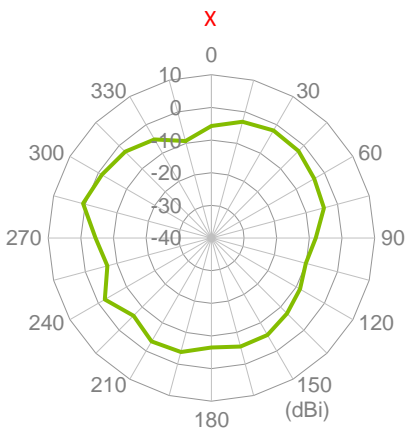

XZ Plane

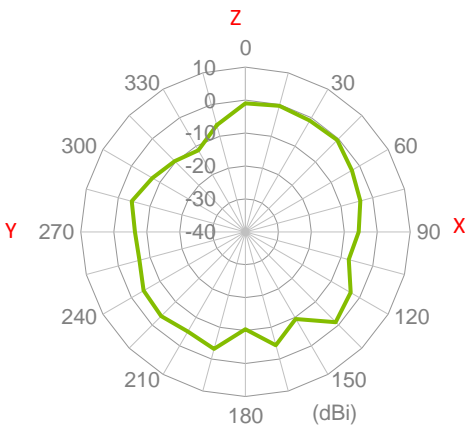

YZ Plane

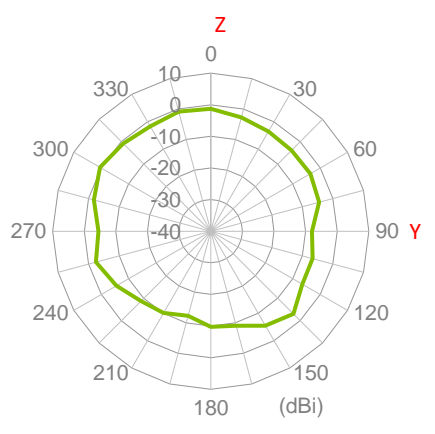

2690MHz

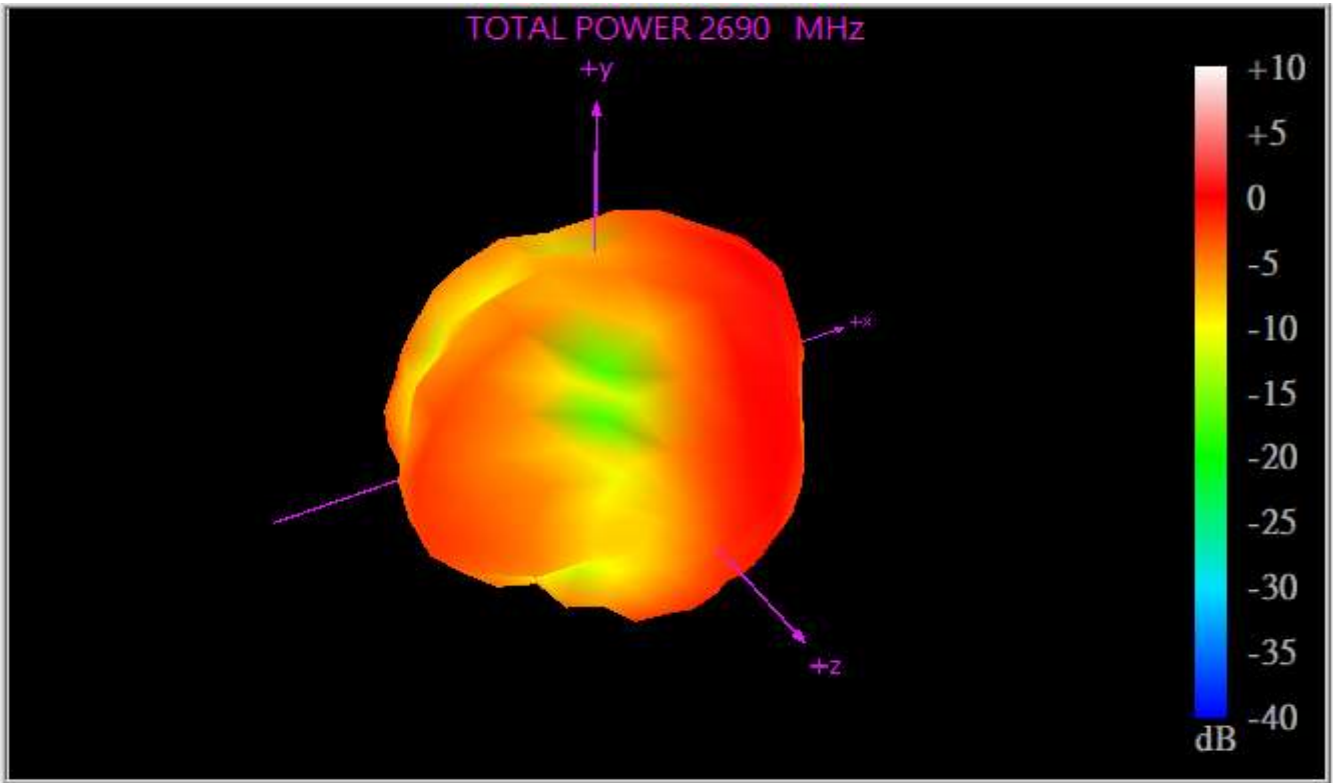

XY Plane

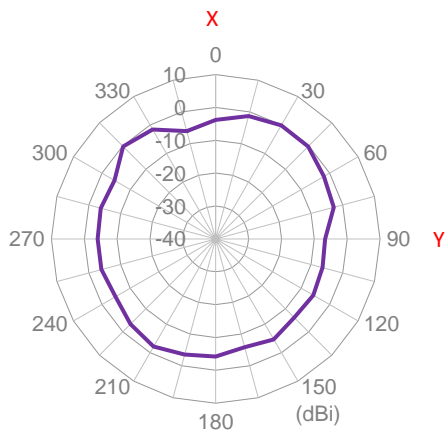

XZ Plane

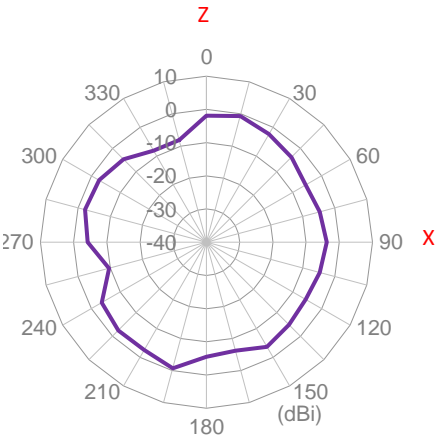

YZ Plane

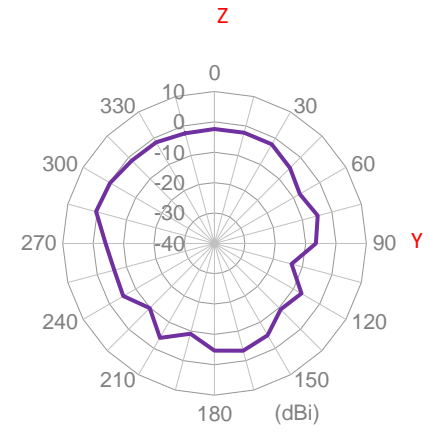

3300MHz

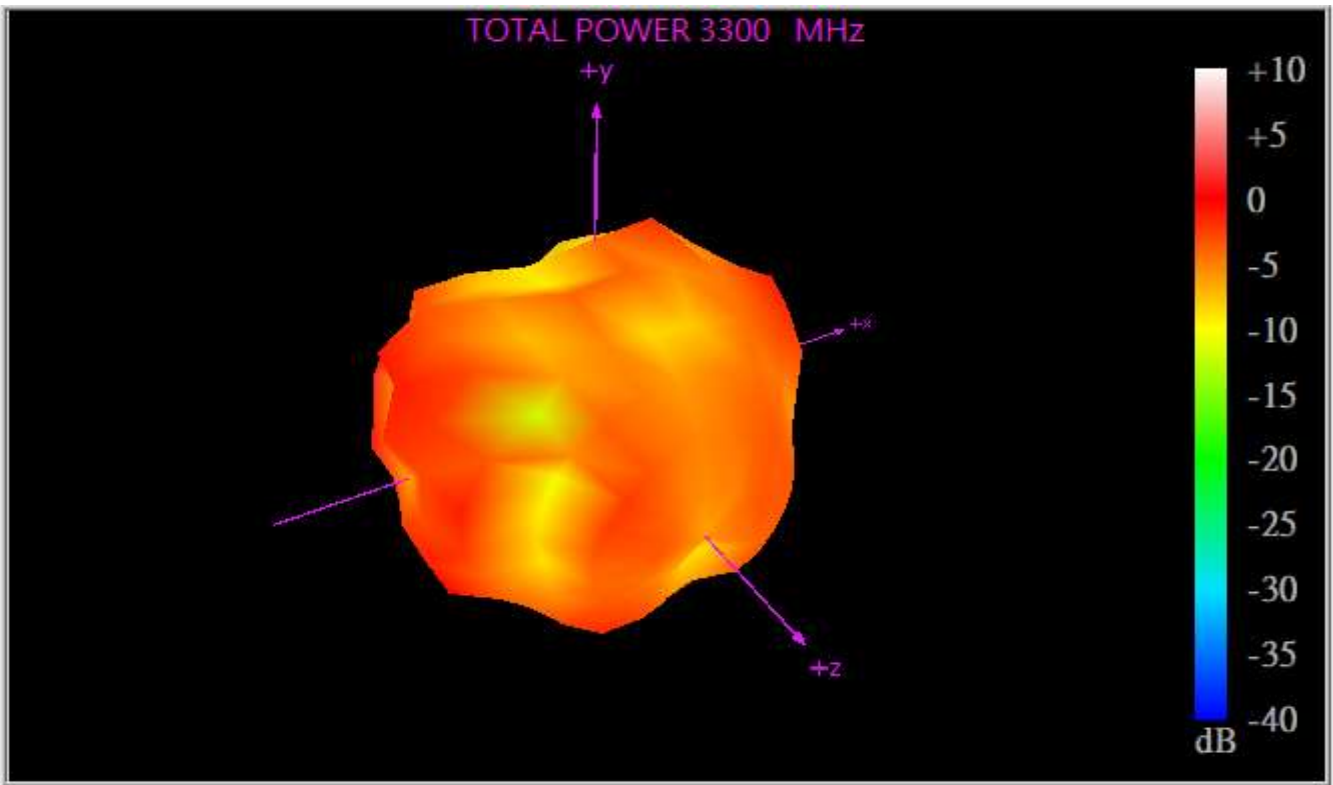

XY Plane

XZ Plane

YZ Plane

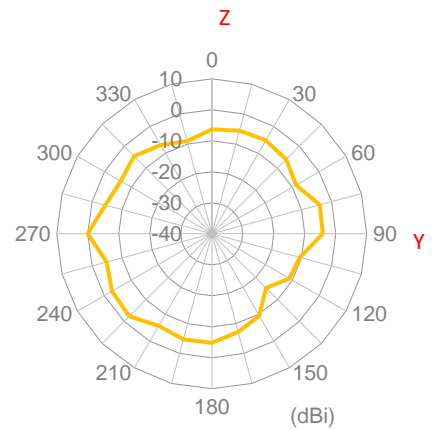
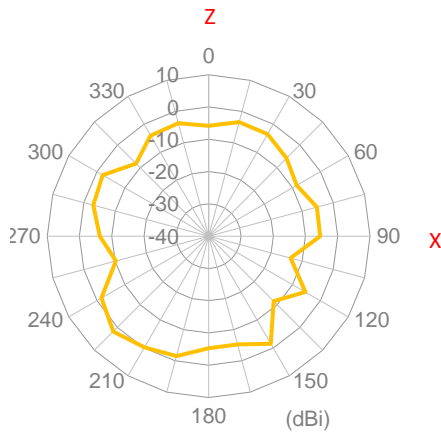
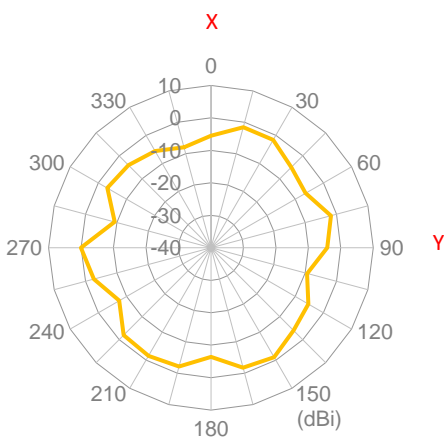

3400MHz

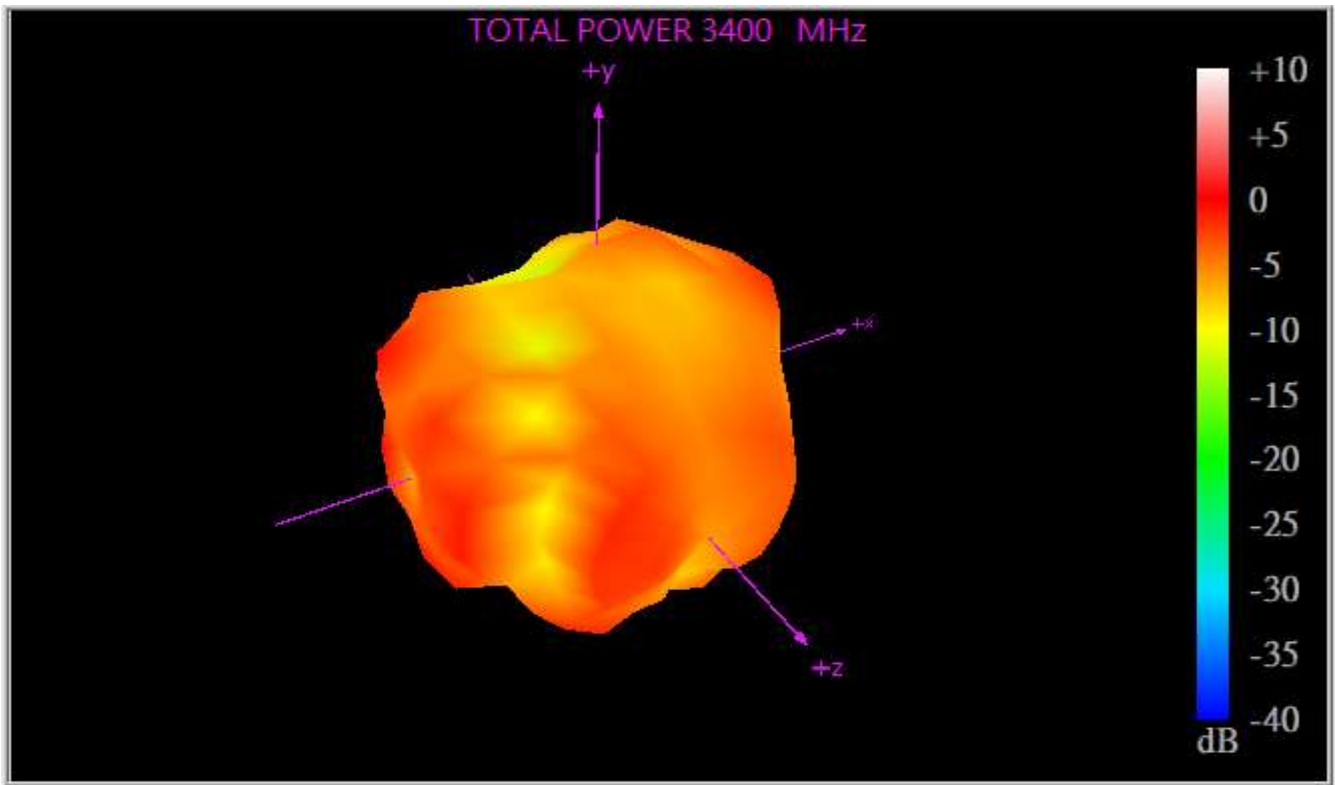

XY Plane

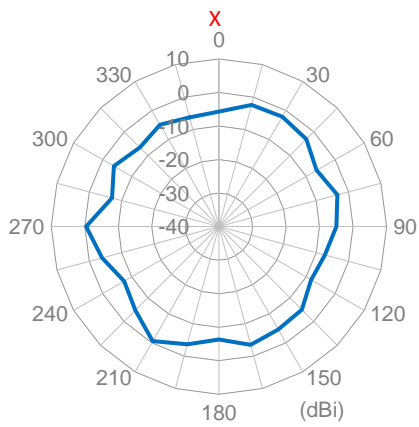

XZ Plane

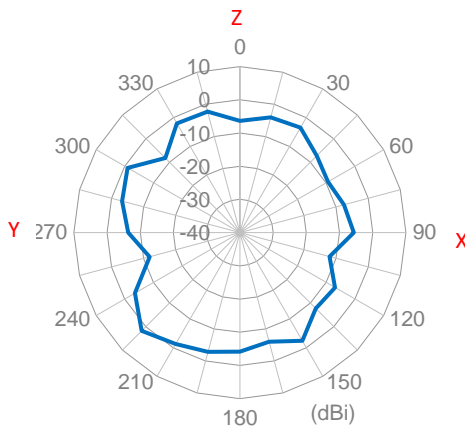

YZ Plane

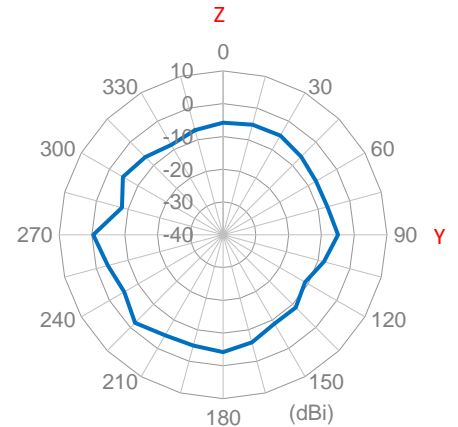

3500MHz

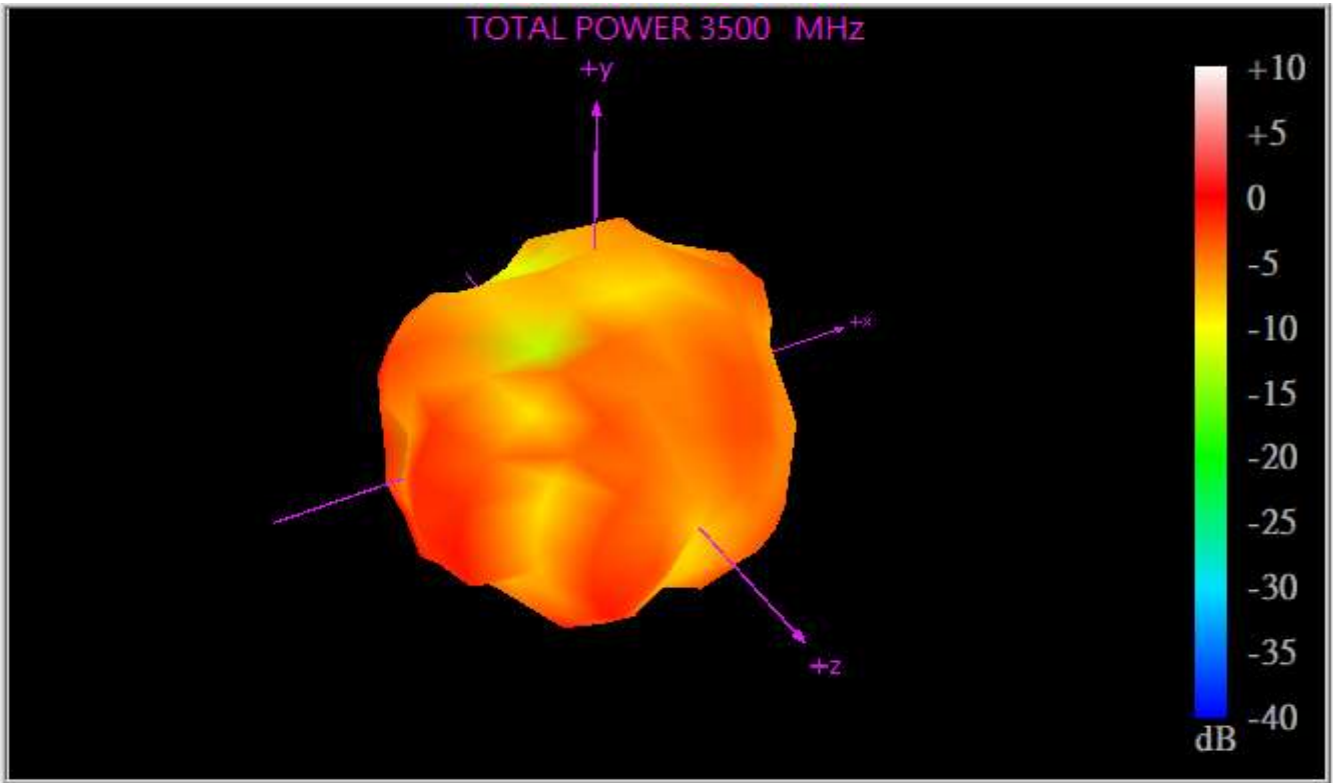

XY Plane

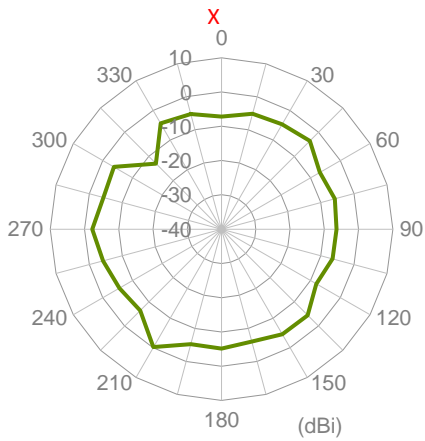

XZ Plane

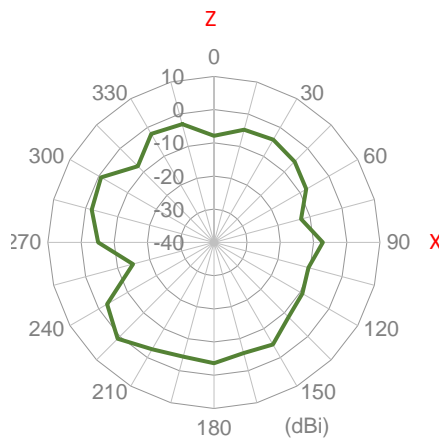

YZ Plane

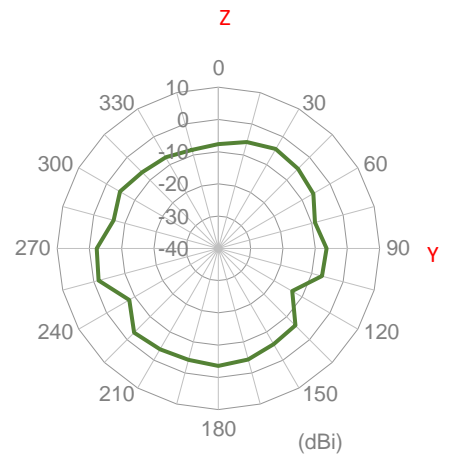

5150MHz

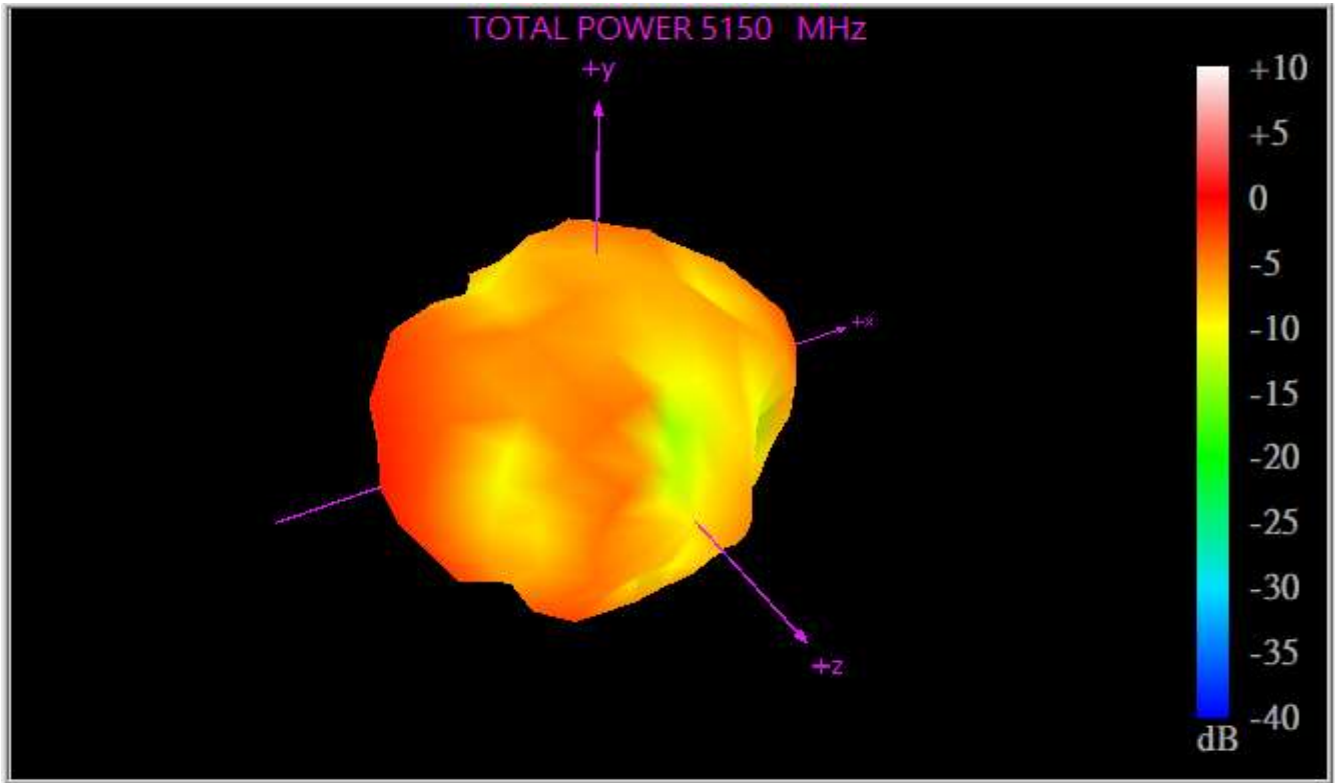

XY Plane

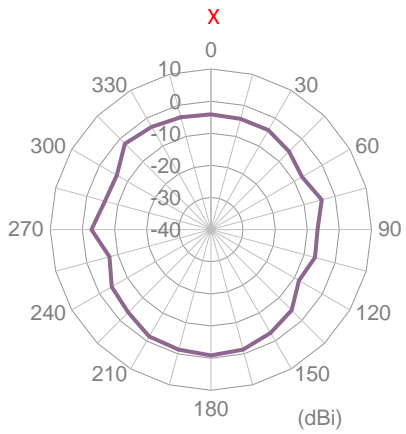

XZ Plane

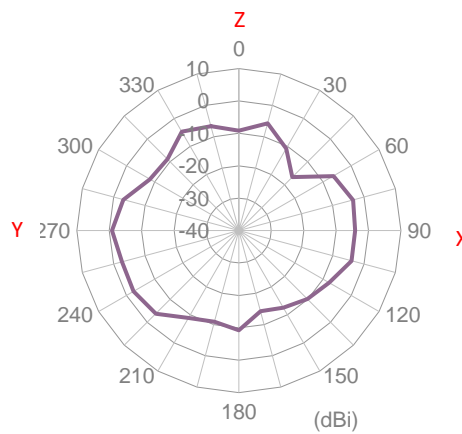

YZ Plane

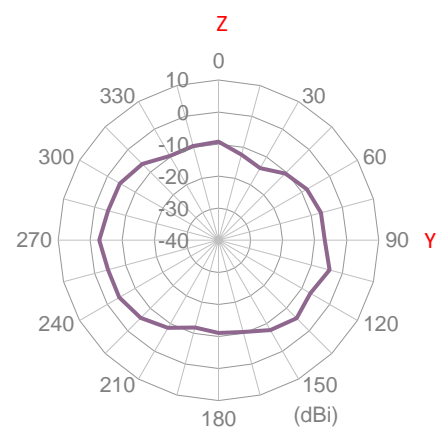

5550MHz

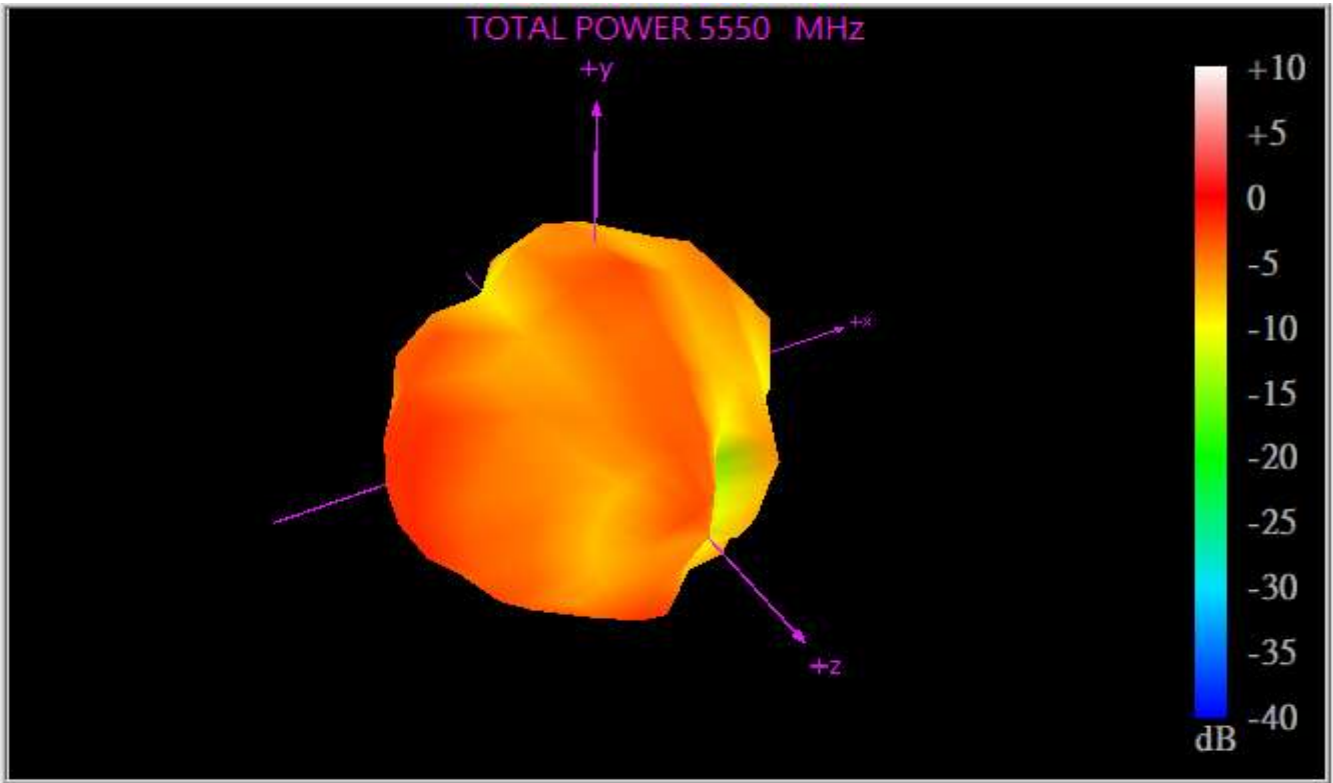

XY Plane

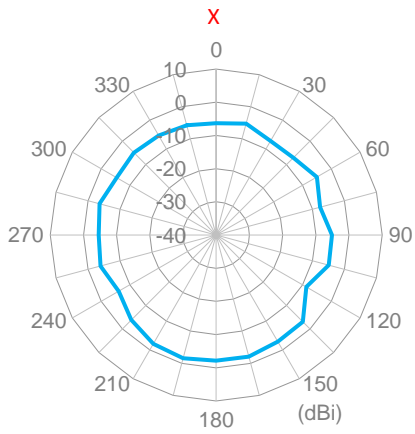

XZ Plane

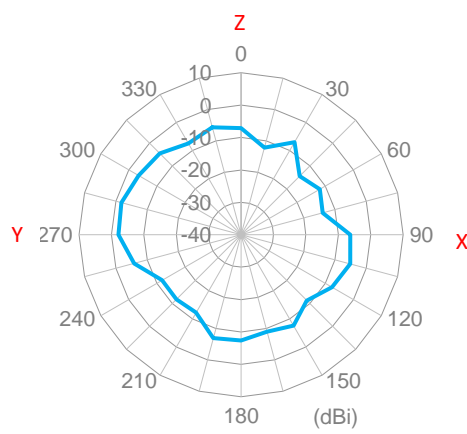

YZ Plane

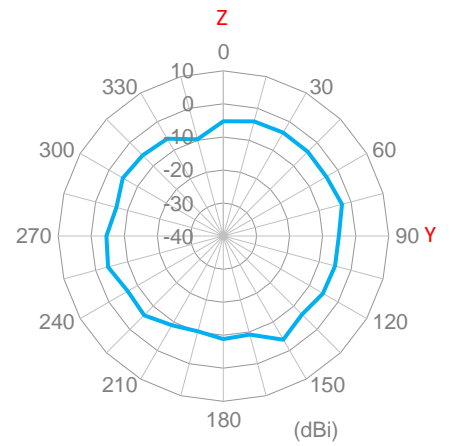



5925MHz

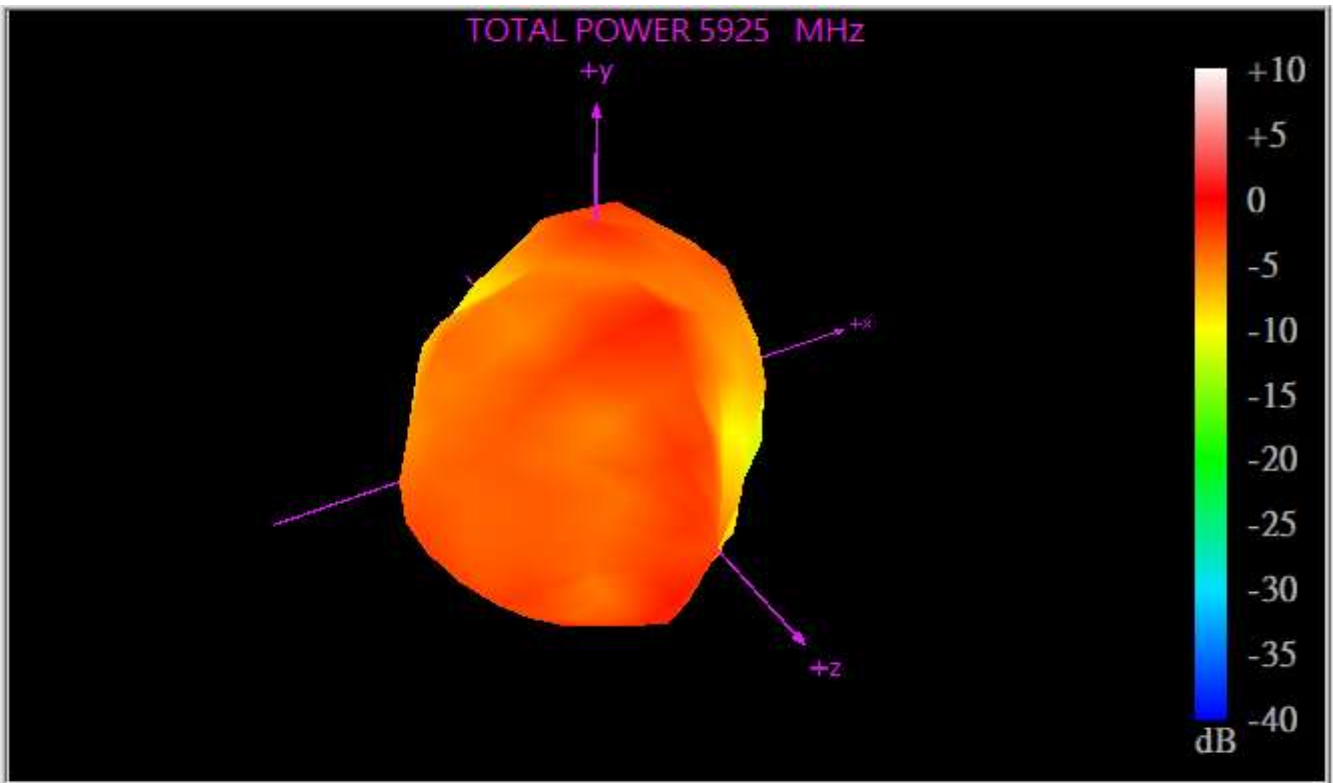

XY Plane

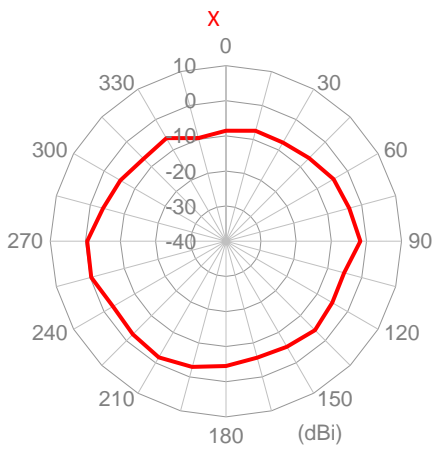

XZ Plane

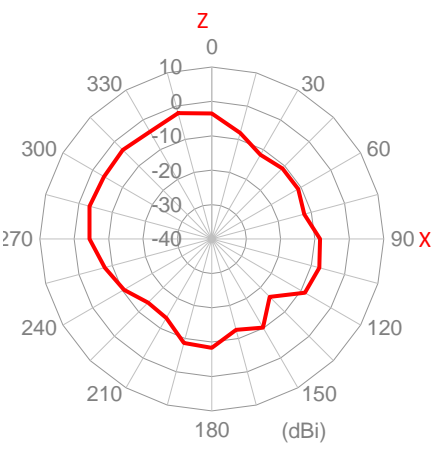

YZ Plane

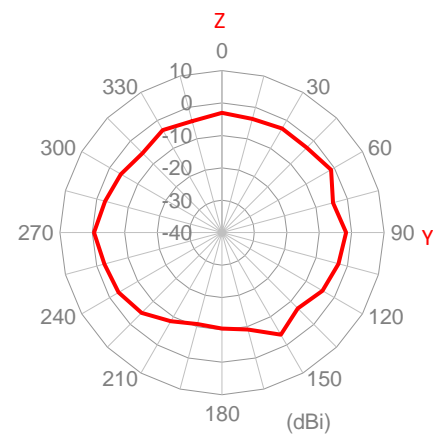

# 5. Mechanical Drawing (Units: mm)

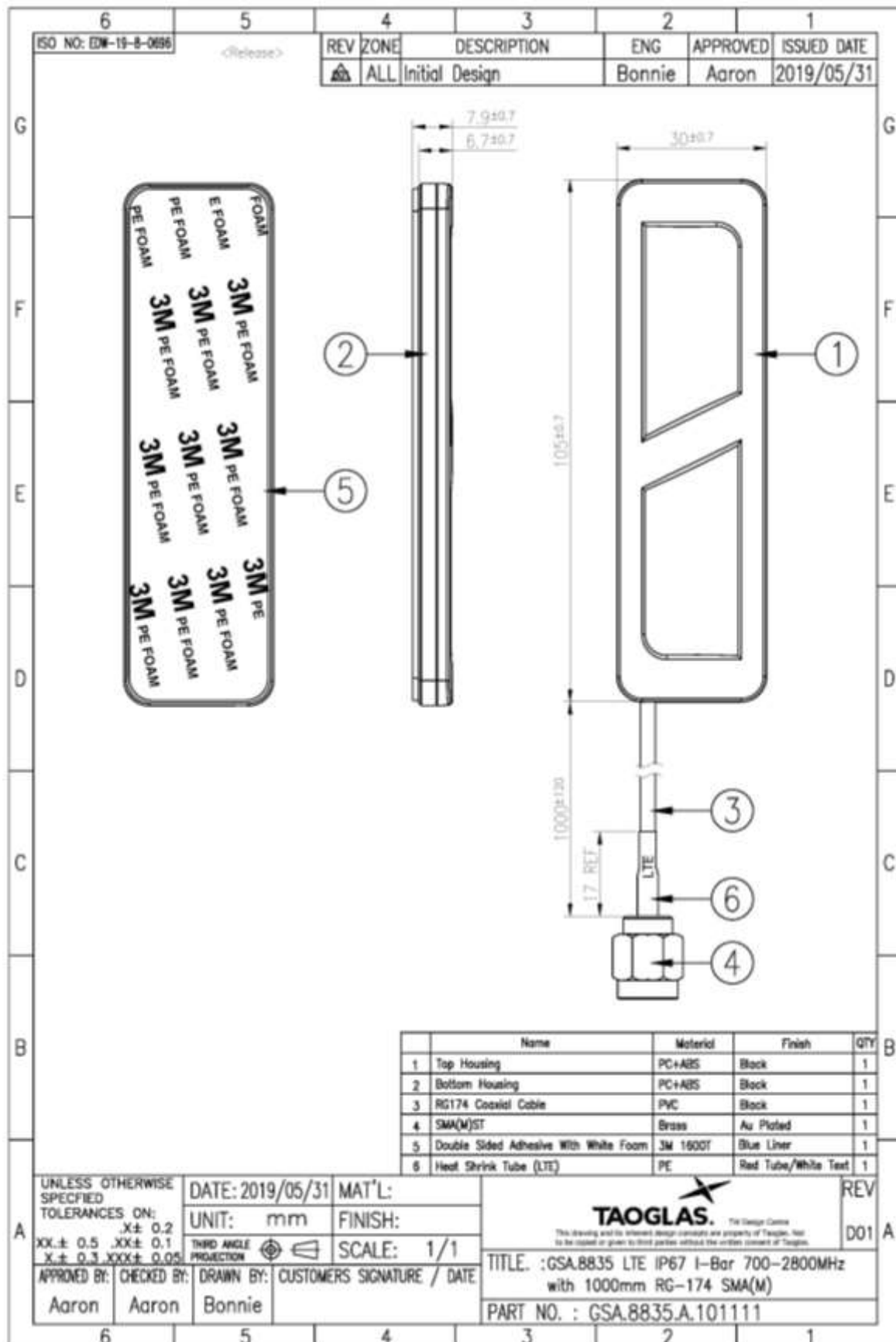

## 6. Packaging

1pcs GSA.8835.A.101111 per Small PE Bag  
 Dimensions - 200\*80mm  
 Weight - 39g



10pcs GSA.8835.A.101111 per Large PE Bag  
 Dimensions - 460\*250mm  
 Weight - 440g



200pcs GSA.8835.A.101111 per carton  
 Dimensions - 400\*330\*230mm  
 Weight - 9.75Kg

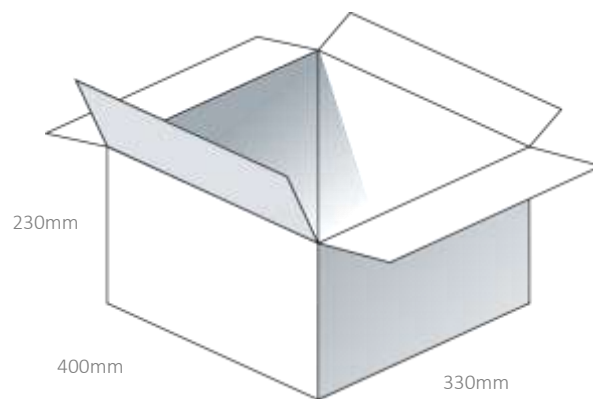

Pallet Dimensions:  
 1200\*1000\*1350mm  
 45 Cartons Per Pallet  
 9 Cartons Per Layer, 5 Layers

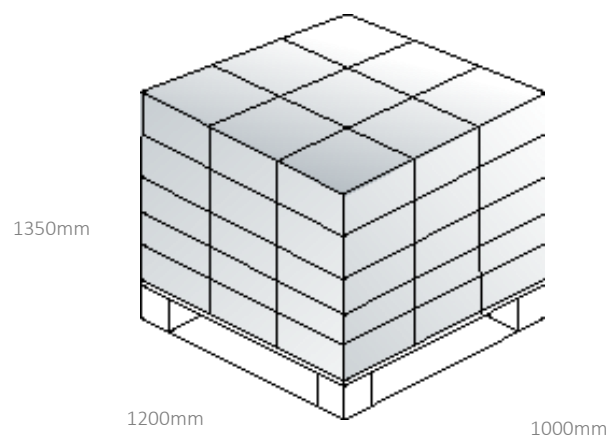

Changelog for the datasheet

**SPE-19-8-112 – GSA.8835.A.101111**

<b>Revision: B (Current Version)</b>	
Date:	2021-03-08
Notes:	Update Antenna Weight
Author:	Gary West

**Previous Revisions**

<b>Revision: A (Original First Release)</b>	
Date:	2019-08-21
Notes:	
Author:	Jack Conroy



**TAOGLAS**®

[www.taoglas.com](http://www.taoglas.com)

# Mouser Electronics

Authorized Distributor

Click to View Pricing, Inventory, Delivery & Lifecycle Information:

[Taoglas:](#)

[GSA.8835.A.101111](#)