



TAOGLAS®



Datasheet

Part No:
FXUB63.07.0150C

Description
LTE Wide Band Flex Antenna 600MHz -6000 MHz

Features:
Ground Plane Independent
Flexible polymer material
Covering: 600-6000 MHz
I-PEX MHF® I (U.FL comp)
150mm Ø1.37 coaxial cable
Dimensions: 96*21*0.2 mm
RoHS & Reach Compliant

1.	Introduction	2
2.	Specification	3
3.	Antenna Characteristics	5
4.	Radiation Patterns	8
5.	Mechanical Drawing	23
6.	Packaging	24
<hr/>		
	Changelog	25

Taoglas makes no warranties based on the accuracy or completeness of the contents of this document and reserves the right to make changes to specifications and product descriptions at any time without notice. Taoglas reserves all rights to this document and the information contained herein. Reproduction, use or disclosure to third parties without express permission is strictly prohibited.



1. Introduction



The patent pending FXUB63 flexible wideband antenna has been designed to cover all working frequencies in the 600-6000MHz spectrum, covering all Cellular, 2.4GHz Wi-Fi, ISM and AGPS. The antenna is delivered with a flexible body with excellent efficiencies on all bands, ground independent, with cable and connector for easy installation.

The FXUB63 flexible polymer antenna, at 96*21*0.2mm, is ultra thin and wideband with high efficiencies across the bands. It is assembled by a simple “peel and stick” process, attaching securely to non-metal surfaces via 3M adhesive. It enables designers to use only one antenna that covers all common LTE frequencies.

The FXUB63 antenna is a durable flexible polymer antenna that has a peak gain of 5dBi, an efficiency of more than 45% across the bands and is designed to be mounted directly onto a plastic or glass cover. It is an ideal choice for any device maker that needs to keep manufacturing costs down over the lifetime of a product. It is ground plane independent and delivered with a cable and connector for easy connecting to the wireless module or customer PCB.

Cables and Connectors are customizable. Like all such antennas, care should be taken to mount the antenna at least 10mm from metal components or surfaces, and ideally 20mm for best radiation efficiency.

2. Specification

LTE Electrical								
Band	Frequency (MHz)	Efficiency (%)	Average Gain (dB)	Peak Gain (dBi)	Impedance	Polarization	Radiation Pattern	Max. input power
5G NR/4G Band 71	617-698	26.2	-5.82	-0.32	50 Ω	Linear	Omni	5W
4G/3G Band 12,13,14,17,28,29	698-806	24.6	-6.09	0.36				
4G/3G/NB-IoT/Cat M Band 5,8,18,19,20,26,27	824-960	57.4	-2.41	3.78				
5G NR/4G Band 21,32,74,75,76	1427-1518	67.0	-1.74	3.53				
4G/3G Band 1,2,3,4,9,23,25,35,39,66	1710-2200	67.5	-1.71	4.83				
4G/3G Band 7,30,38,40,41	2300-2690	74.3	-1.29	6.22				
5G NR/4G Band 22,42,48,77,78,79	3300-5000	37.9	-4.22	3.80				
LTE5200/Wi-Fi5800	5150-5925	33.1	-4.80	4.96				

Mechanical	
Dimensions (mm)	96*21*0.2 mm
Material	Flexible Polymer
Connector	I-PEX MHFI (U.FL Compatible)
Cable Length	150 mm
Cable	1.37 mm mini coax

Environmental	
Operation Temperature	-40°C to 85°C
Storage Temperature	-40°C to 85°C
Relative Humidity	40% to 95%

5G/4G Bands			
Band Number	5G NR / FR1 / LTE / LTE-Advanced / WCDMA / HSPA / HSPA+ / TD-SCDMA		
	Uplink	Downlink	Covered
B1	1920 to 1980	2110 to 2170	✓
B2	1850 to 1910	1930 to 1990	✓
B3	1710 to 1785	1805 to 1880	✓
B4	1710 to 1755	2110 to 2155	✓
B5	824 to 849	869 to 894	✓
B7	2500 to 2570	2620 to 2690	✓
B8	880 to 915	925 to 960	✓
B9*	1749.9 to 1784.9	1844.9 to 1879.9	✓
B11	1427.9 to 1447.9	1475.9 to 1495.9	✓
B12	699 to 716	729 to 746	✓
B13	777 to 787	746 to 756	✓
B14	788 to 798	758 to 768	✓
B17	704 to 716	734 to 746	✓
B18	815 to 830	860 to 875	✓
B19	830 to 845	875 to 890	✓
B20	832 to 862	791 to 821	✓
B21	1447.9 to 1462.9	1495.9 to 1510.9	✓
B22*	3410 to 3490	3510 to 3590	✓
B23*	2000 to 2020	2180 to 2200	✓
B24	1626.5 to 1660.5	1525 to 1559	✓
B25	1850 to 1915	1930 to 1995	✓
B26	814 to 849	859 to 894	✓
B27*	807 to 824	852 to 869	✓
B28	703 to 748	758 to 803	✓
B29		717 to 728	✓
B30	2305 to 2315	2350 to 2360	✓
B31	452.5 to 457.5	462.5 to 467.5	*
B32		1452 to 1496	✓
B34		2010 to 2025	✓
B35		1850 to 1910	✓
B36		1930 to 1990	✓
B37		1910 to 1930	✓
B38		2570 to 2620	✓
B39		1880 to 1920	✓
B40		2300 to 2400	✓
B41		2496 to 2690	✓
B42		3400 to 3600	✓
B43		3600 to 3800	✓
B45		1447 to 1467	✓
B46		5150 to 5925	✓
B47		5855 to 5925	✓
B48		3550 to 3700	✓
B49		3550 to 3700	✓
B50		1432 to 1517	✓
B51		1427 to 1432	✓
B52		3300 to 3400	✓
B53		2483.5 to 2495	✓
B65	1920 to 2010	2110 to 2200	✓
B66	1710 to 1780	2110 to 2200	✓
B68	698 to 728	753 to 783	✓
B69		2570 to 2620	✓
B70	1695 to 1710	1995 to 2020	✓
B71	663 to 698	617 to 652	✓
B72	451 to 456	461 to 466	*
B73	450 to 455	460 to 465	*
B74	1427 to 1470	1475 to 1518	✓
B75		1432 to 1517	✓
B76		1427 to 1432	✓
B77		3300 to 4200	✓
B78		3300 to 3800	✓
B79		4400 to 5000	✓
B85	698 to 716	728 to 746	✓
B87	410 to 415	420 to 425	*
B88	412 to 417	422 to 427	*

3. Antenna Characteristics

3.1 Return Loss

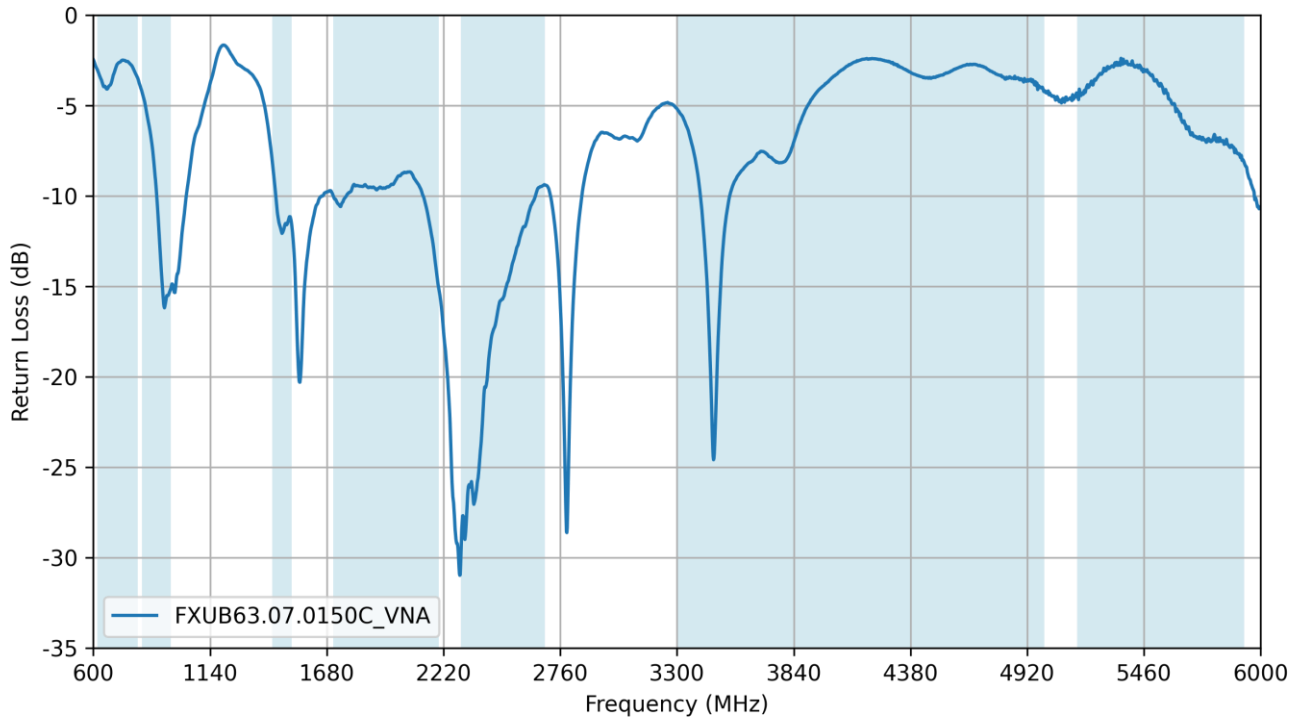

3.2 VSWR

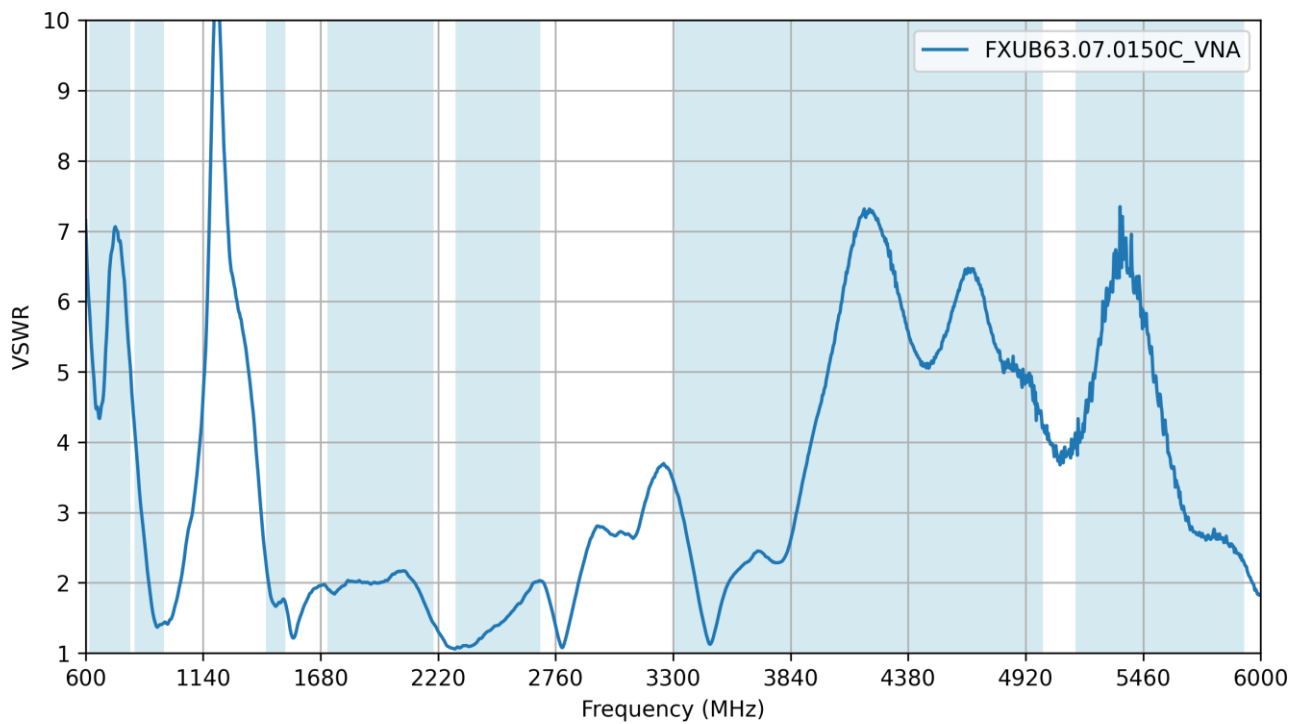

3.3 Efficiency

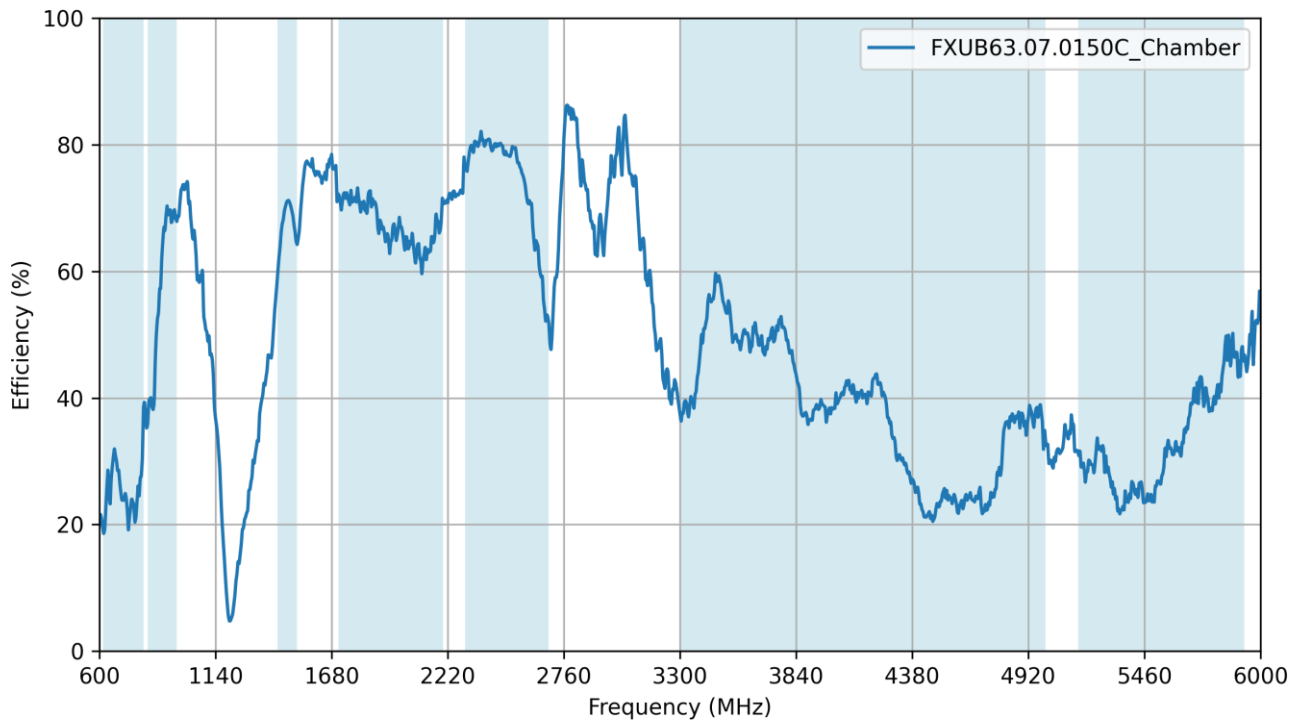

3.4 Average Gain

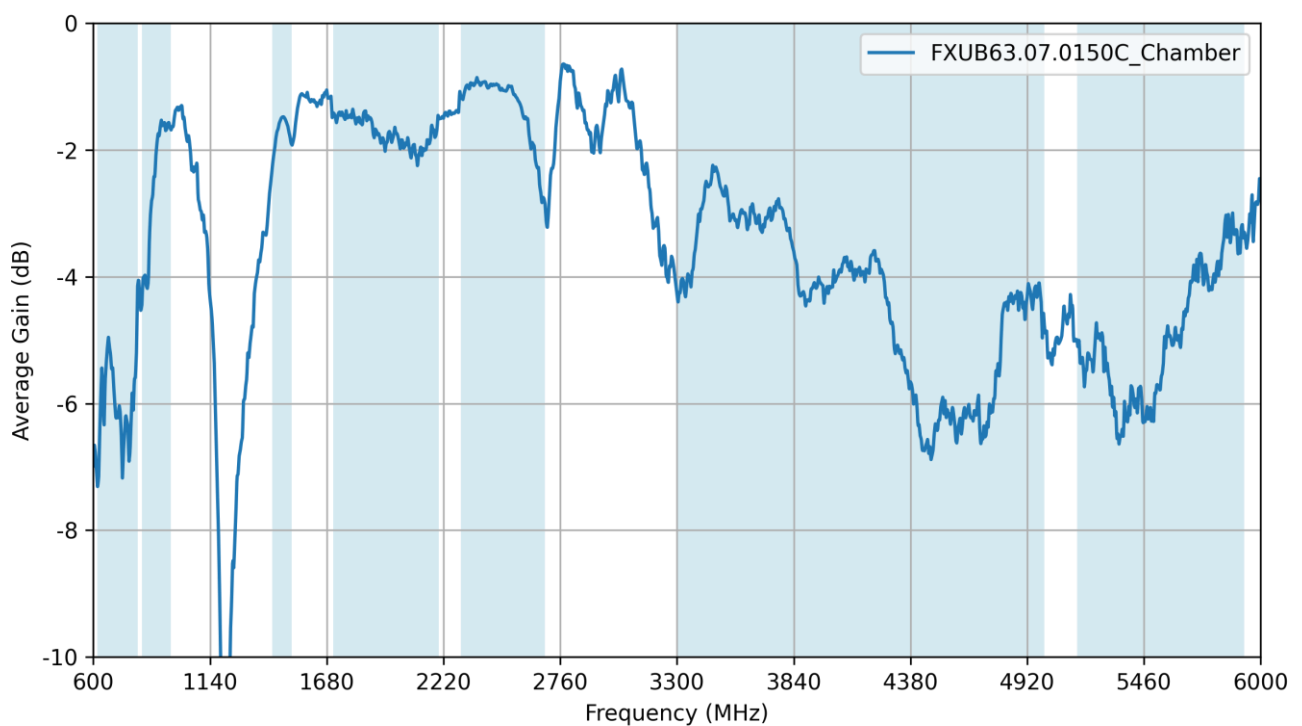

3.5 Peak Gain

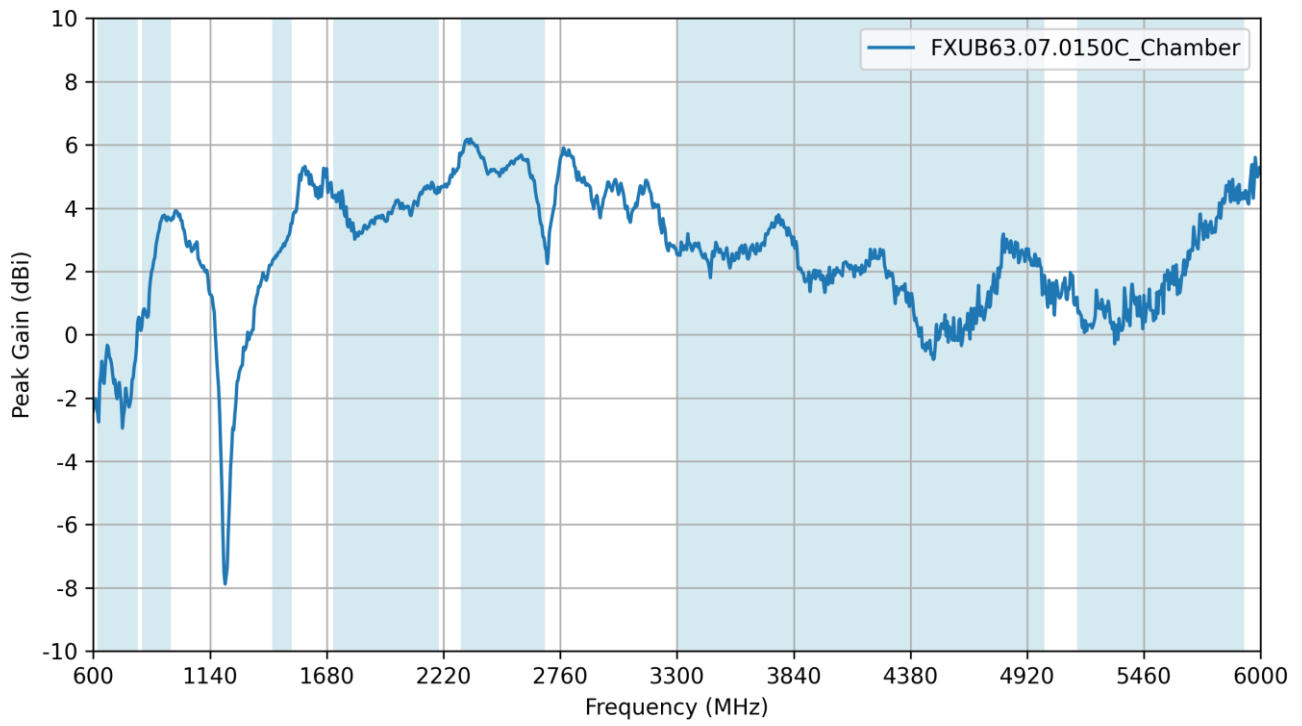

4. Radiation Patterns

4.1 Test Setup

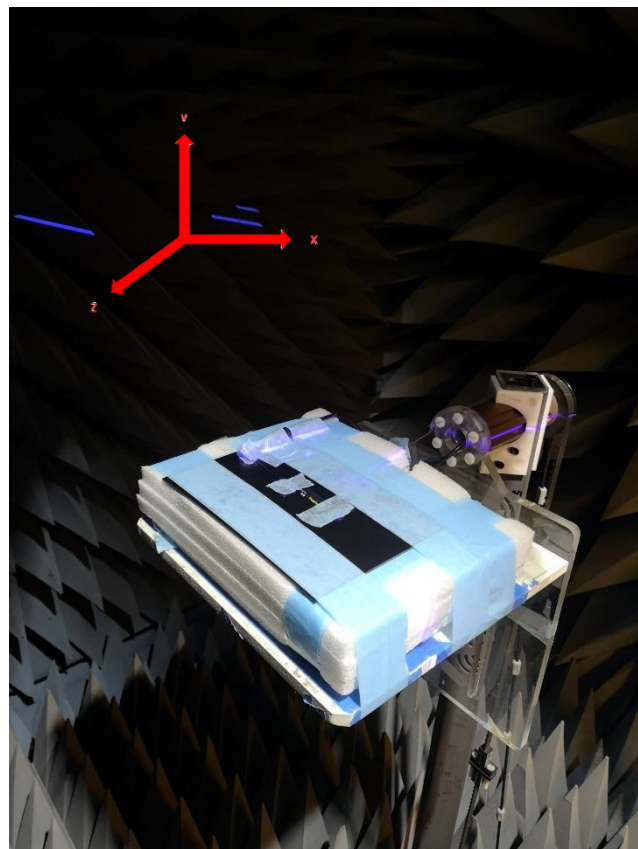
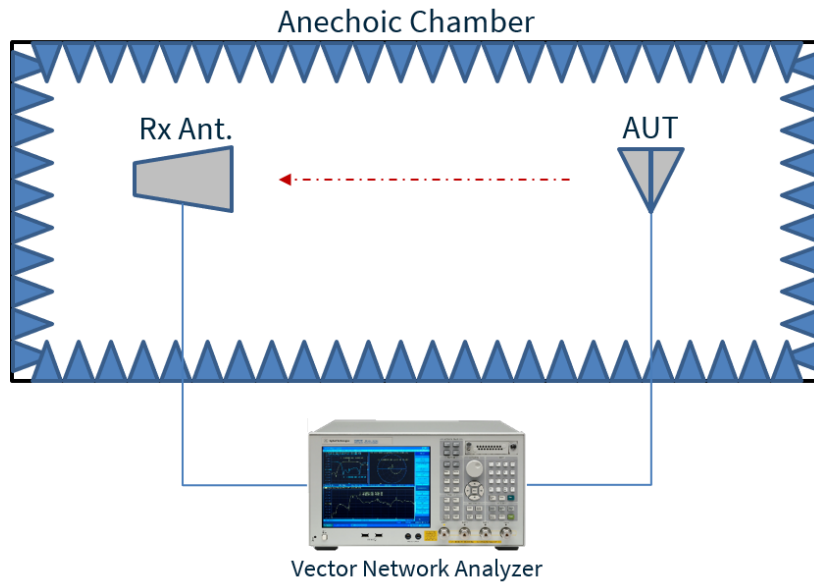

4.2 FXUB63.07.0150C_Chamber Patterns at 650 MHz

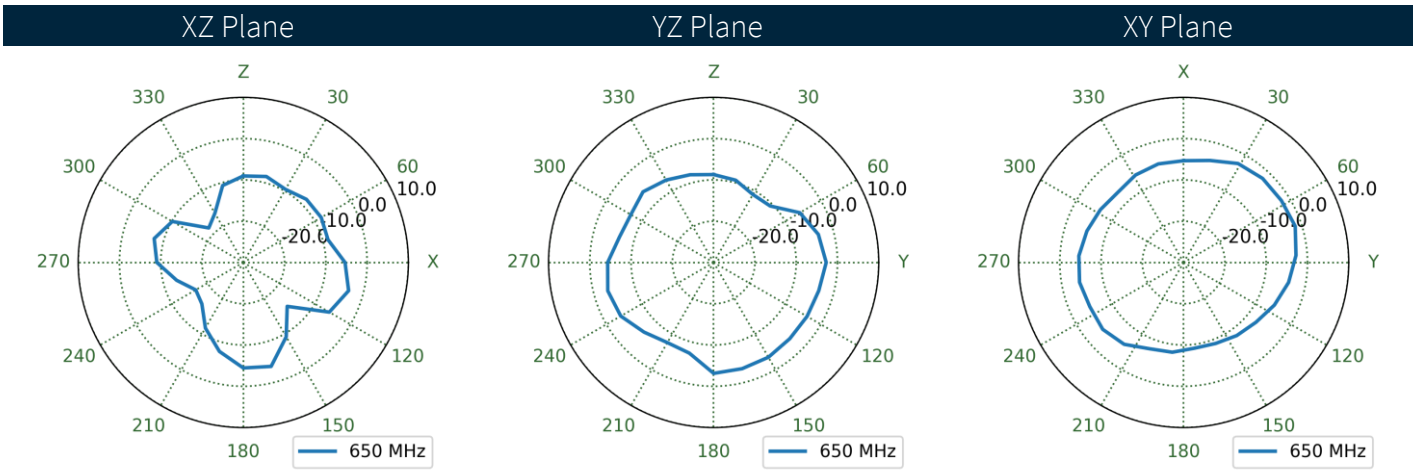
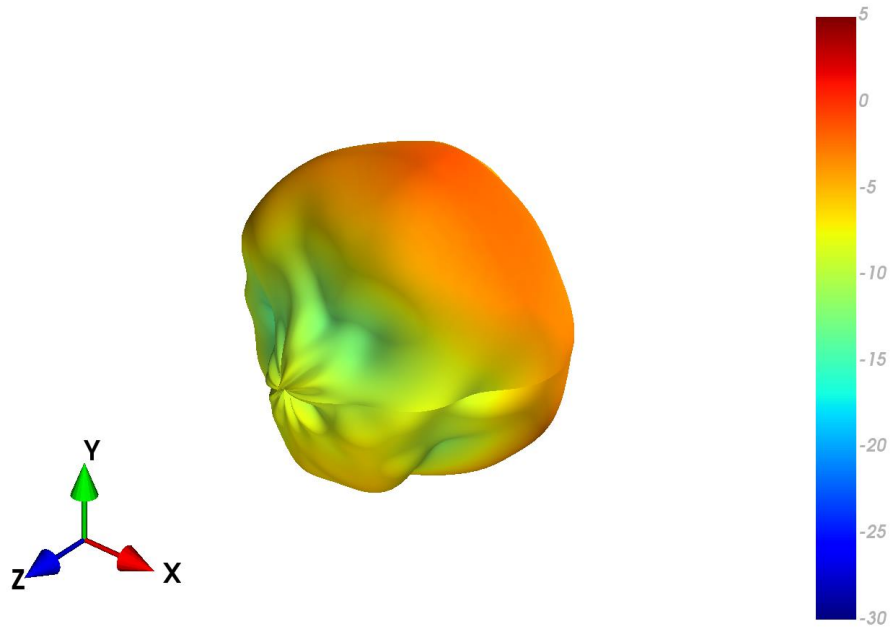

4.3 FXUB63.07.0150C_Chamber Patterns at 750 MHz

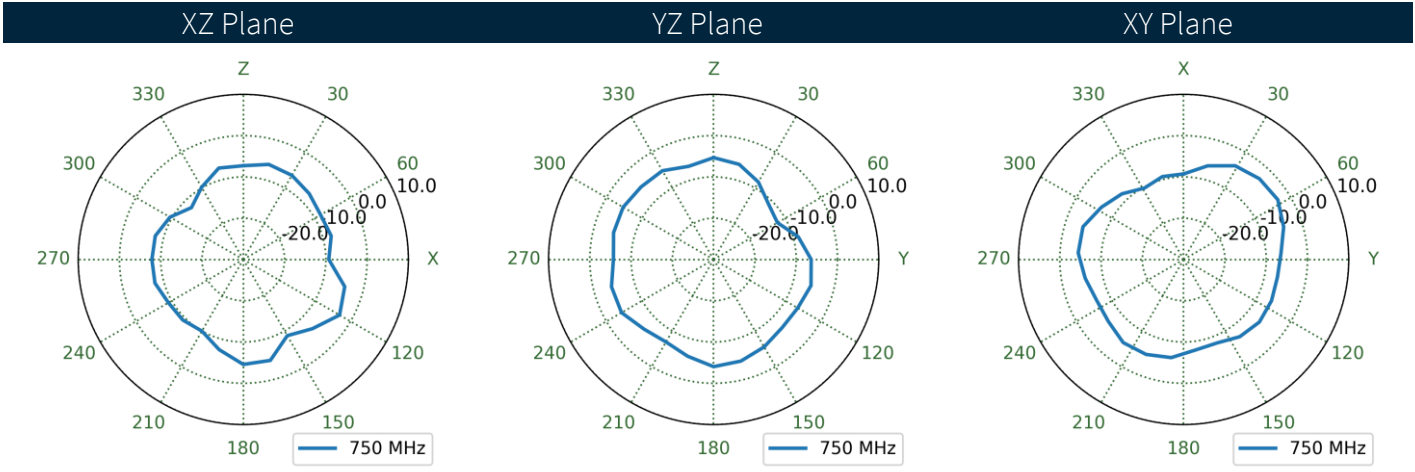
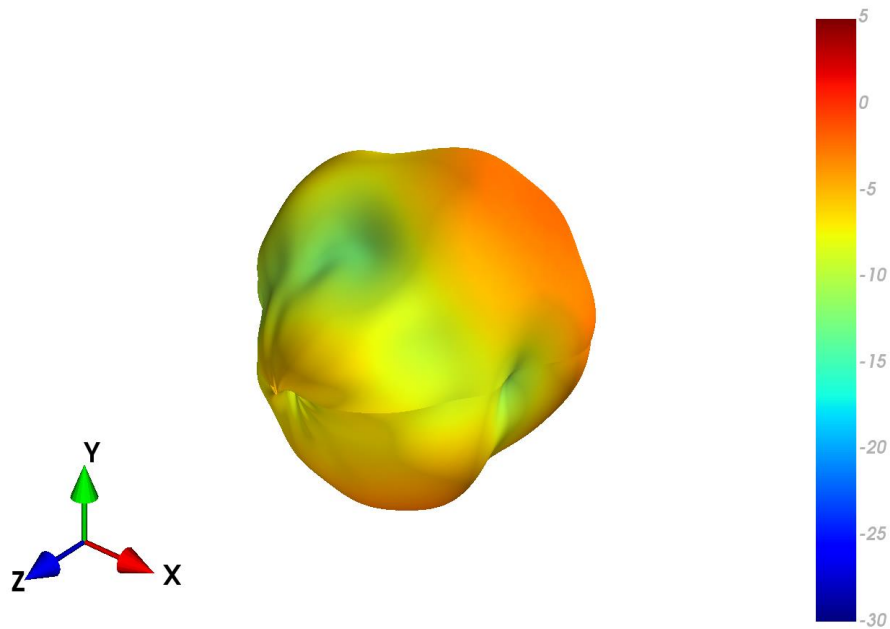

4.4 FXUB63.07.0150C_Chamber Patterns at 850 MHz

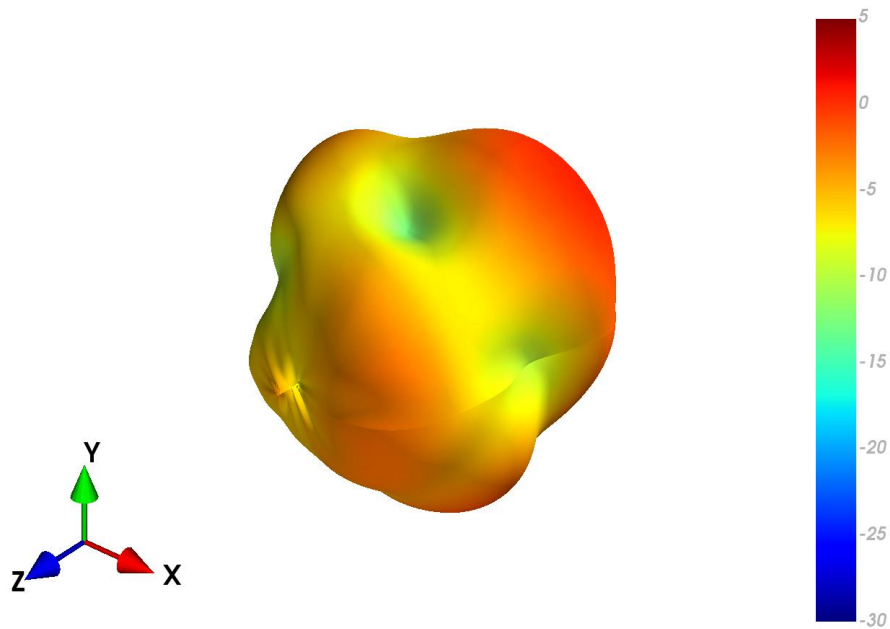

XZ Plane YZ Plane XY Plane

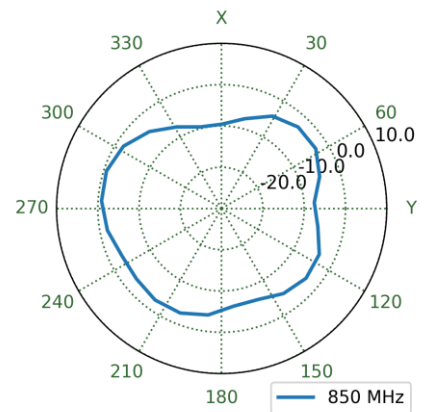
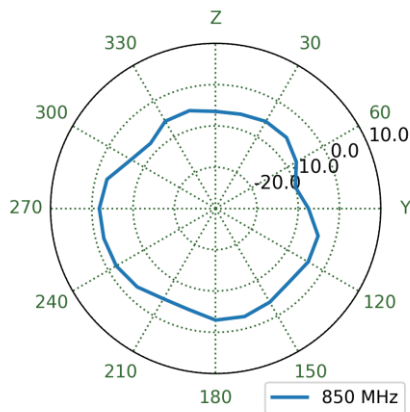
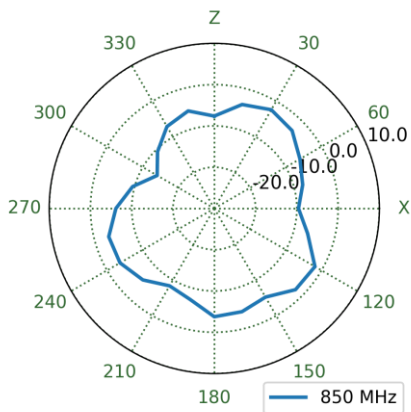

4.5 FXUB63.07.0150C_Chamber Patterns at 1470 MHz

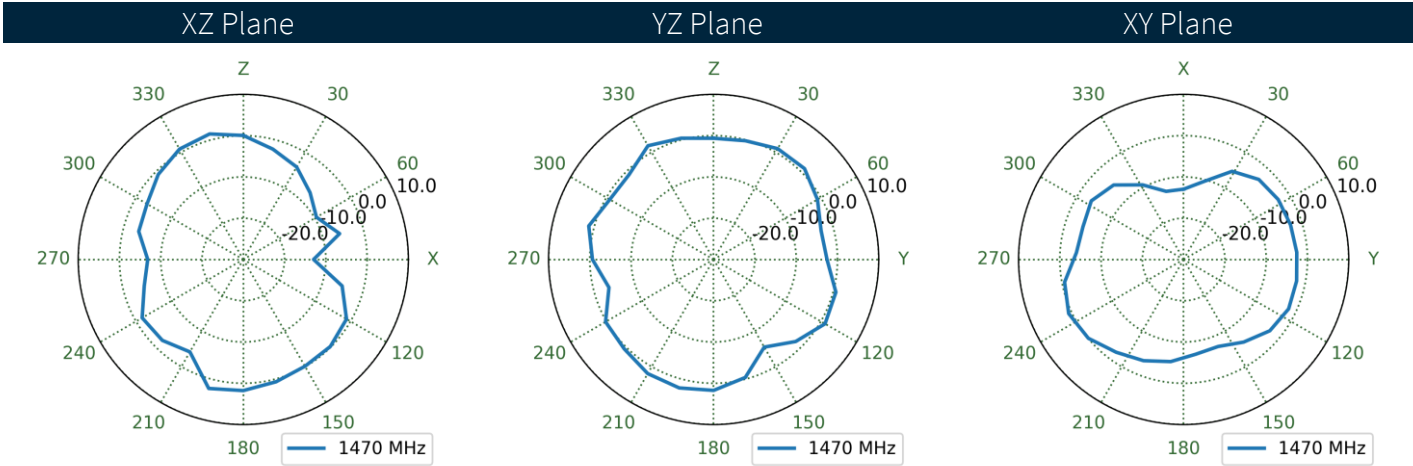
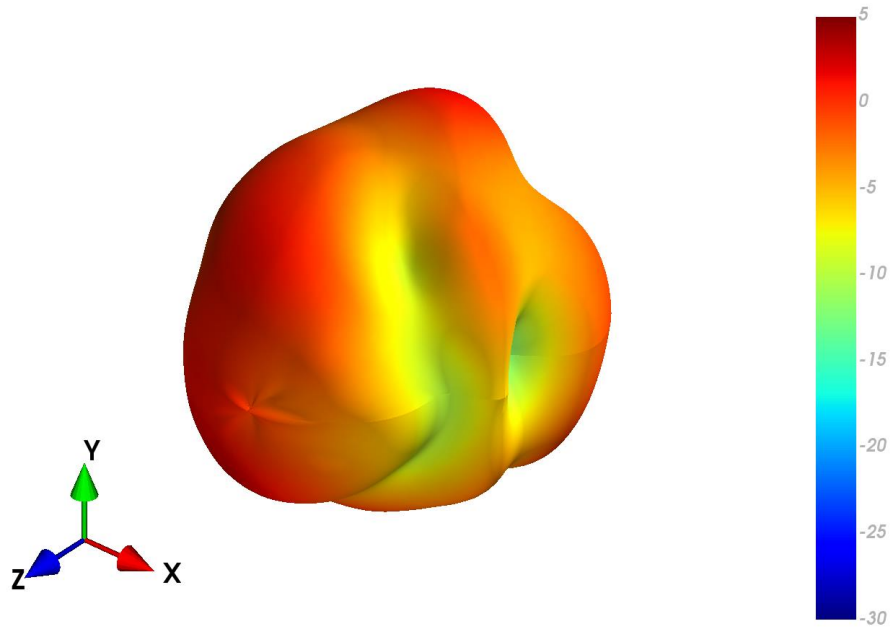

4.6 FXUB63.07.0150C_Chamber Patterns at 1575 MHz

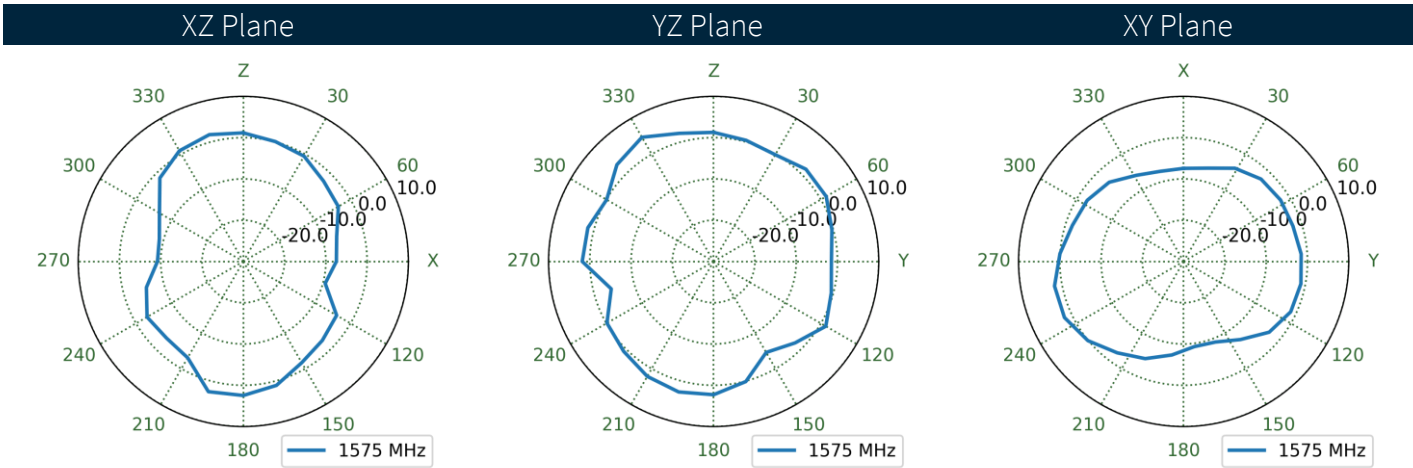
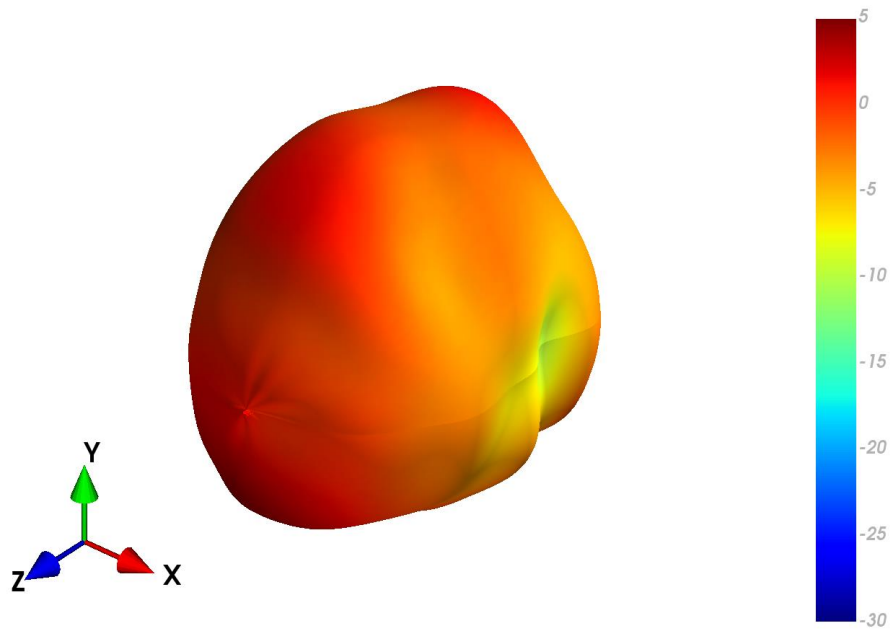

4.7 FXUB63.07.0150C_Chamber Patterns at 1850 MHz

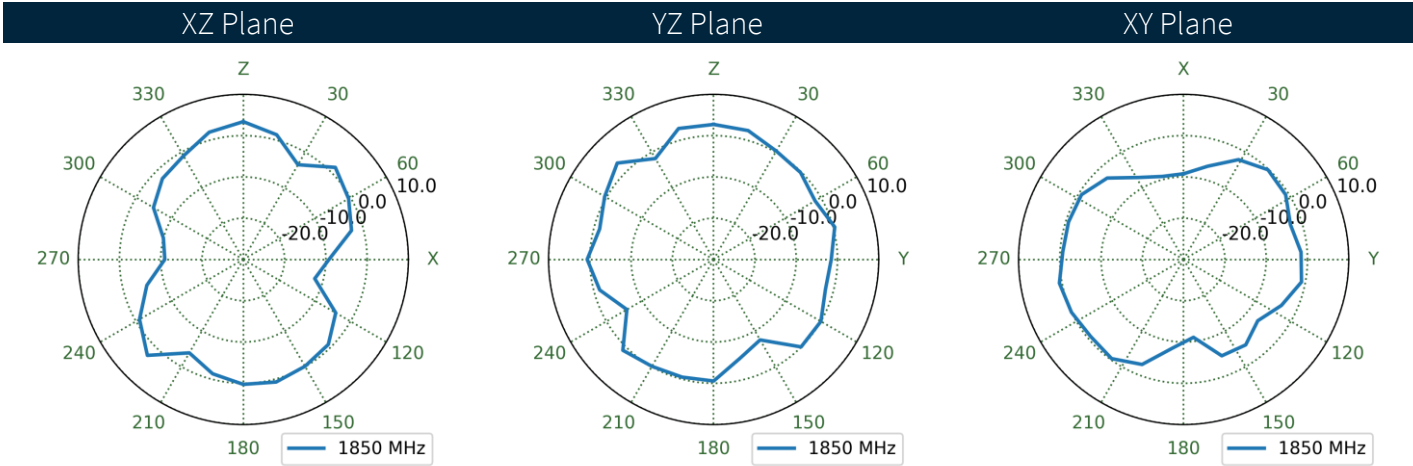
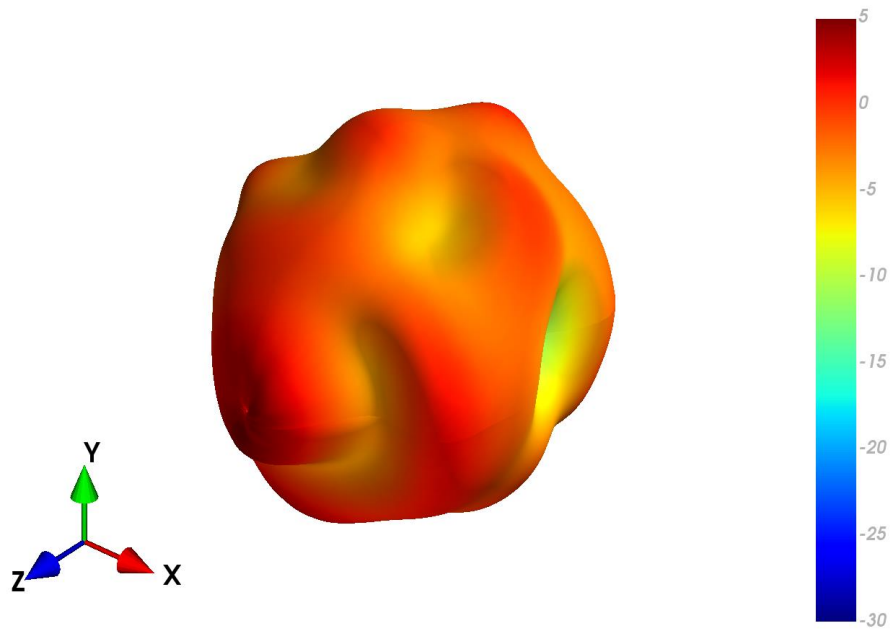

4.8 FXUB63.07.0150C_Chamber Patterns at 1950 MHz

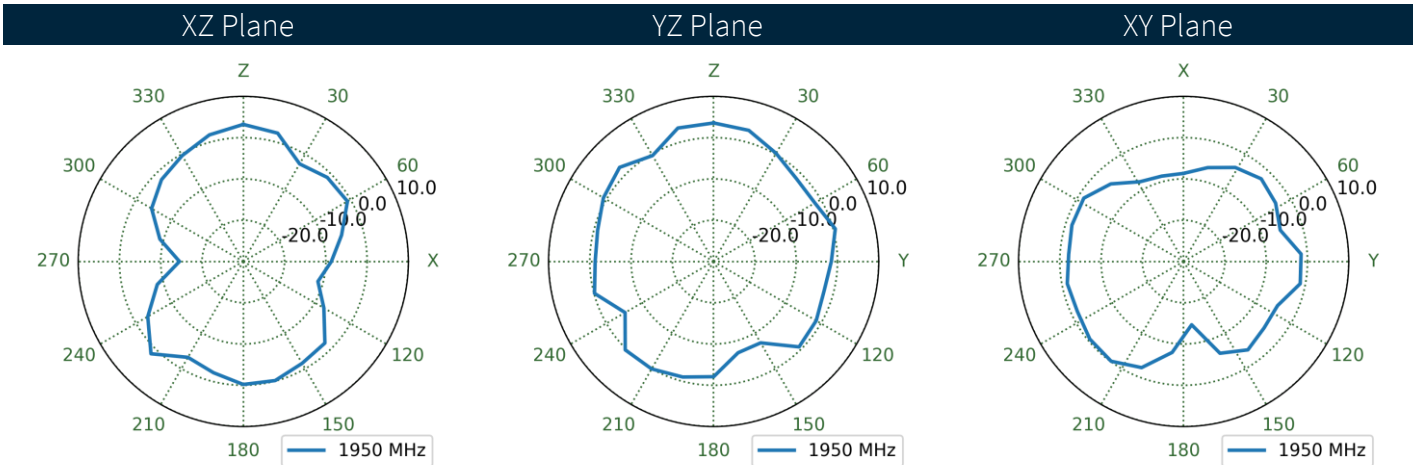
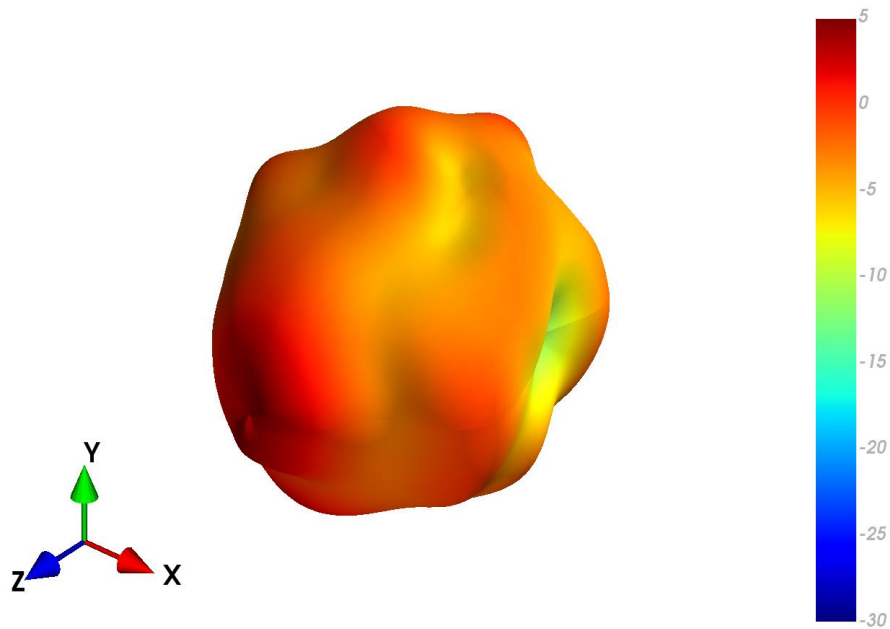

4.9 FXUB63.07.0150C_Chamber Patterns at 2155 MHz

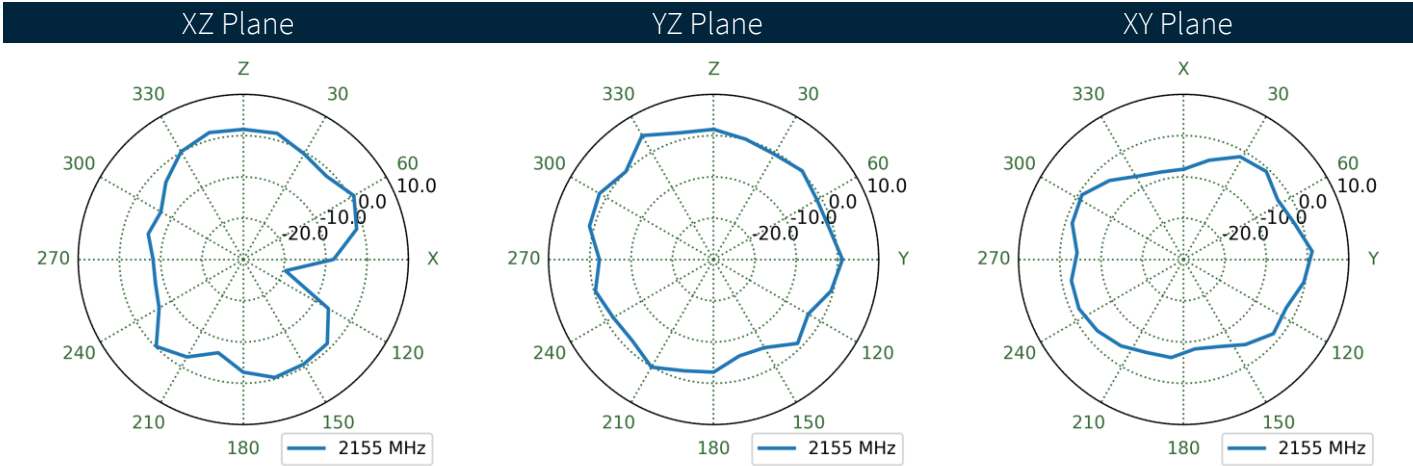
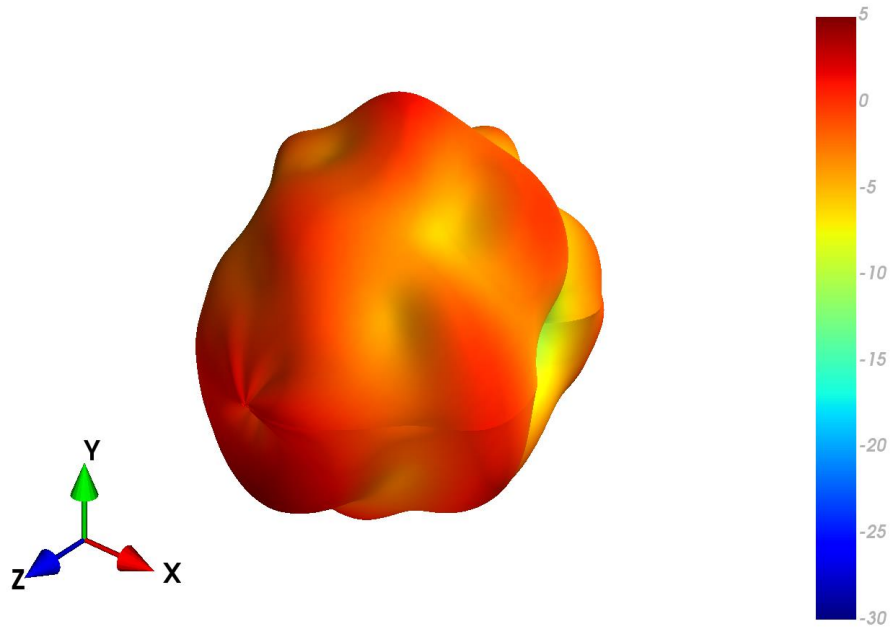

4.10 FXUB63.07.0150C_Chamber Patterns at 2450 MHz

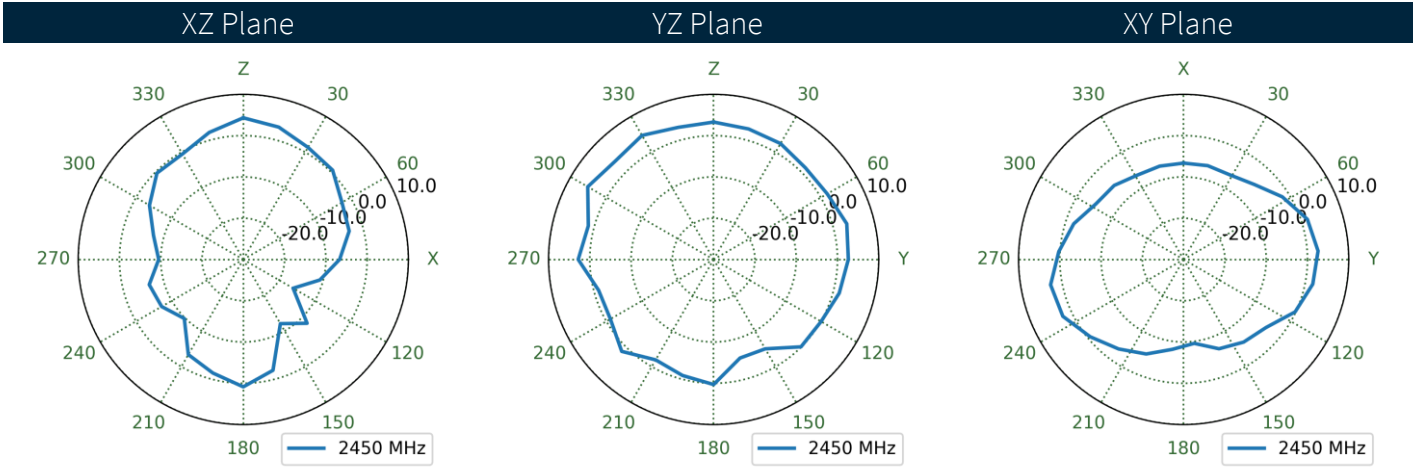
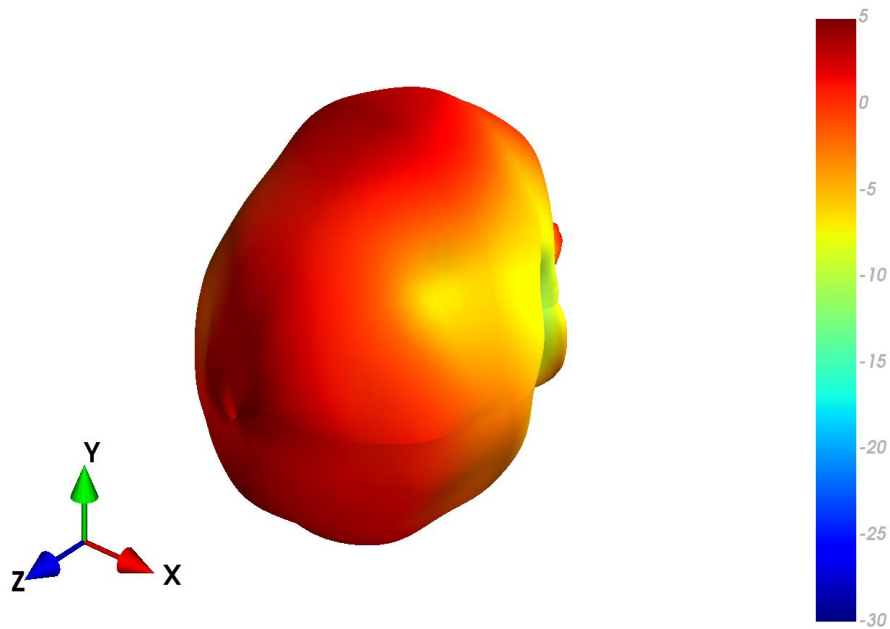

4.11 FXUB63.07.0150C_Chamber Patterns at 2700 MHz

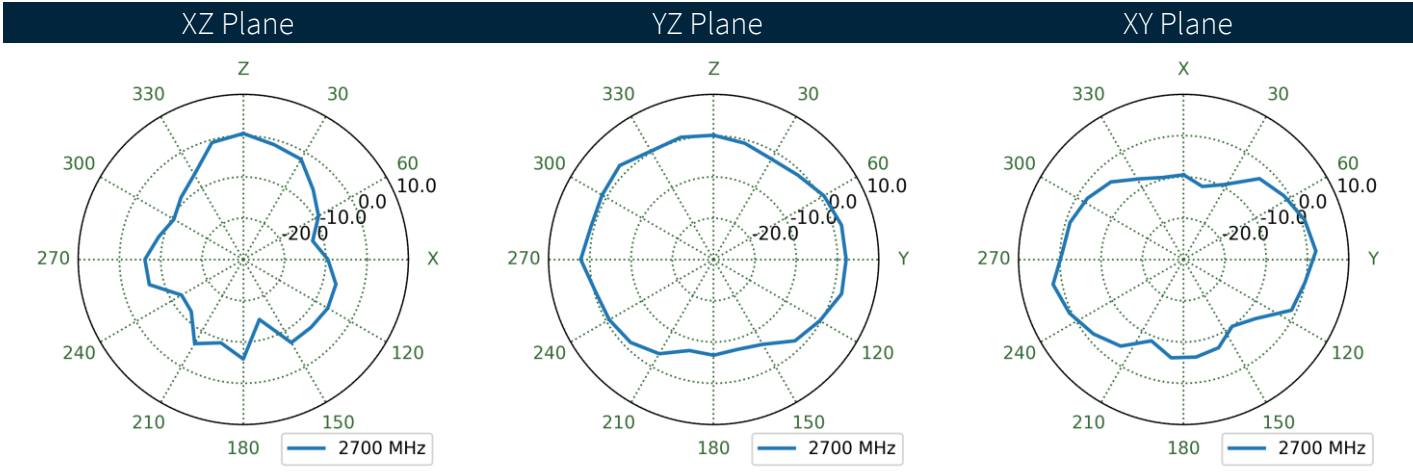
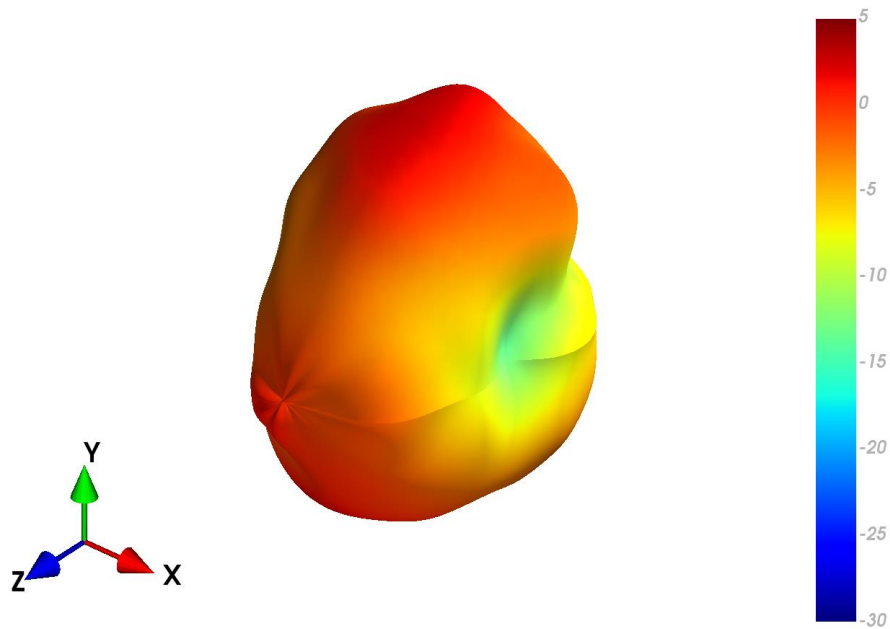

4.12 FXUB63.07.0150C_Chamber Patterns at 3400 MHz

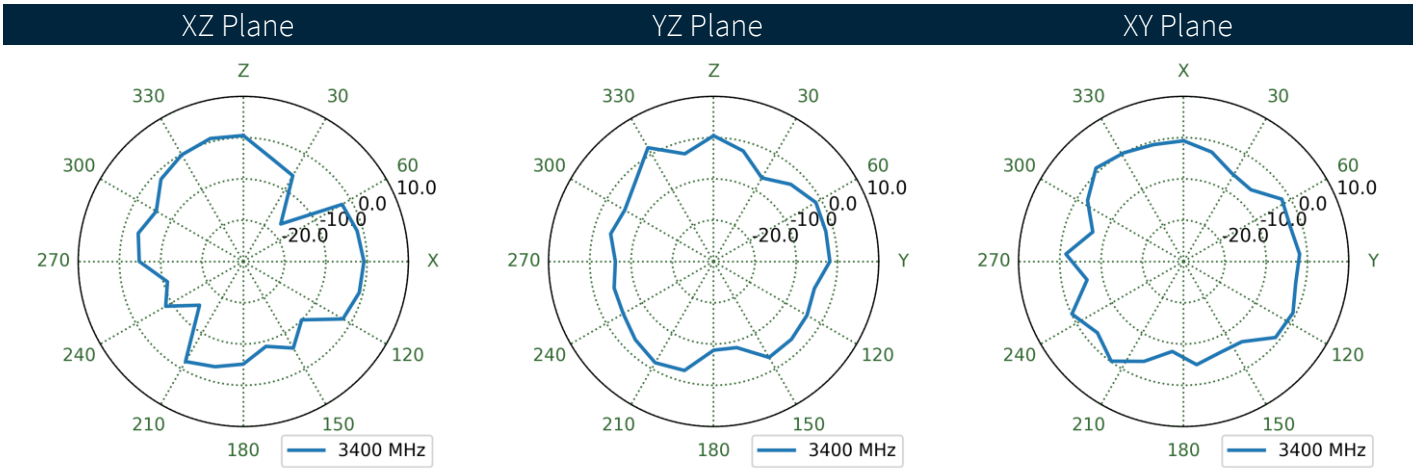
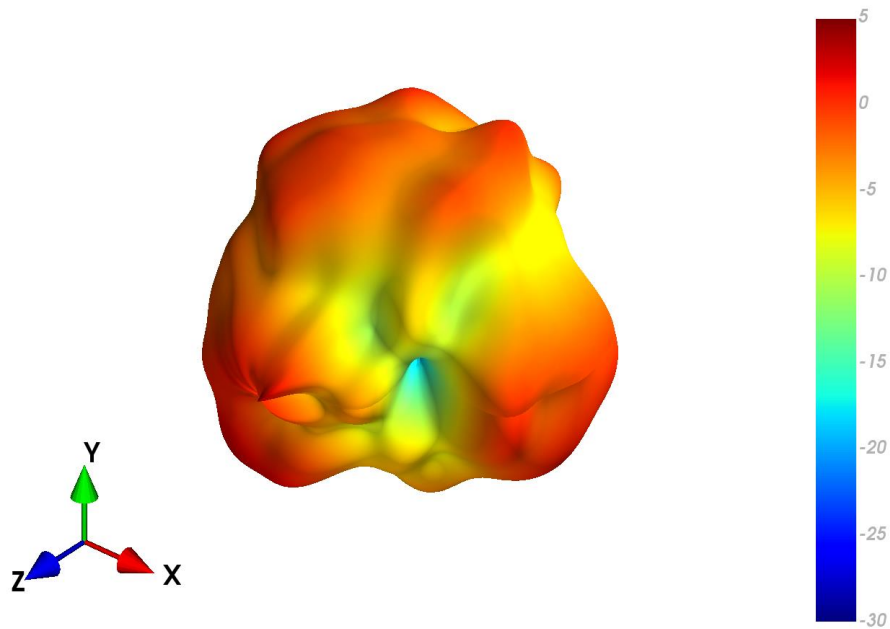

4.13 FXUB63.07.0150C_Chamber Patterns at 4100 MHz

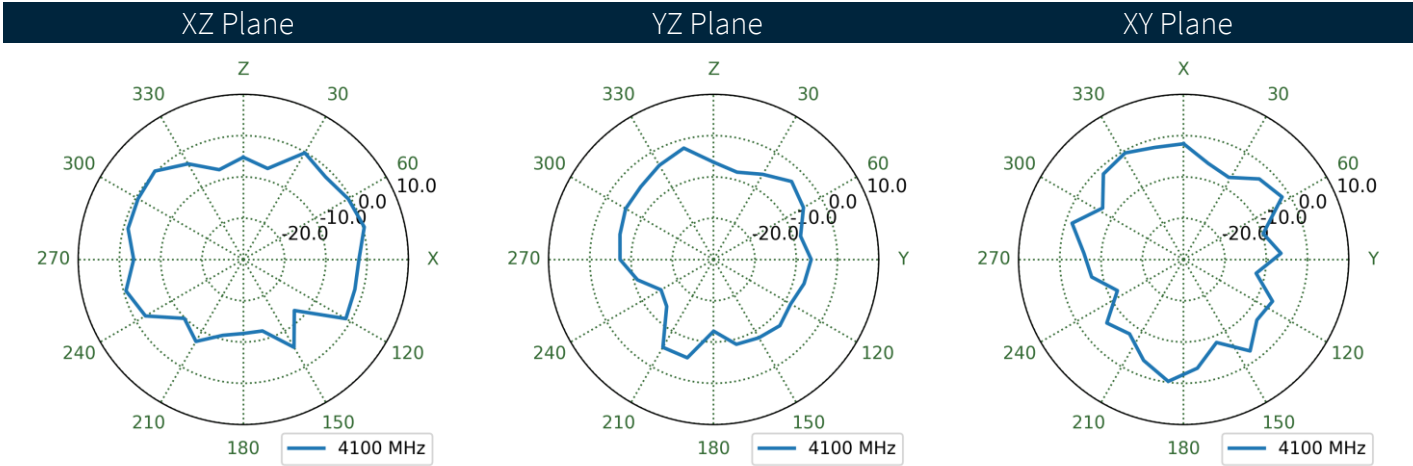
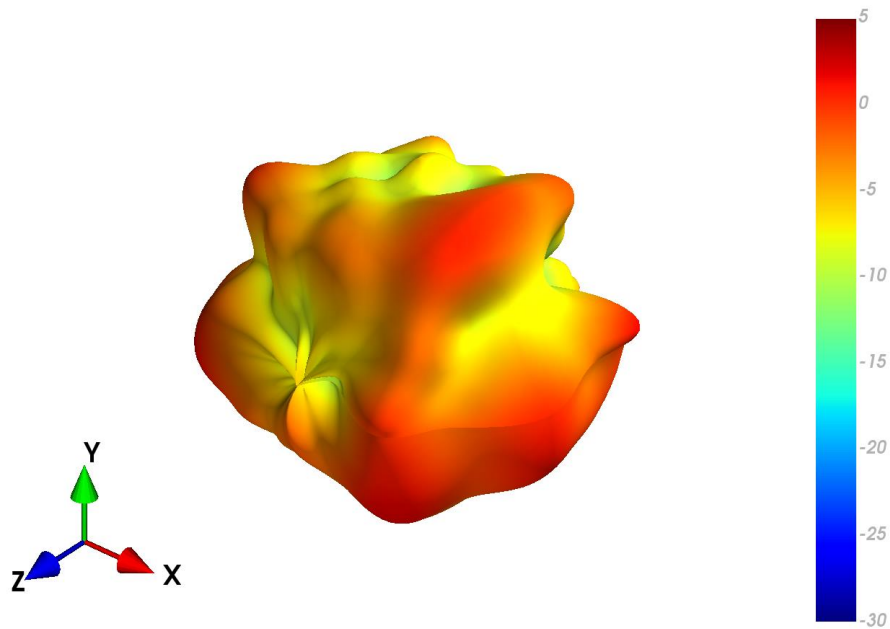

4.14 FXUB63.07.0150C_Chamber Patterns at 5150 MHz

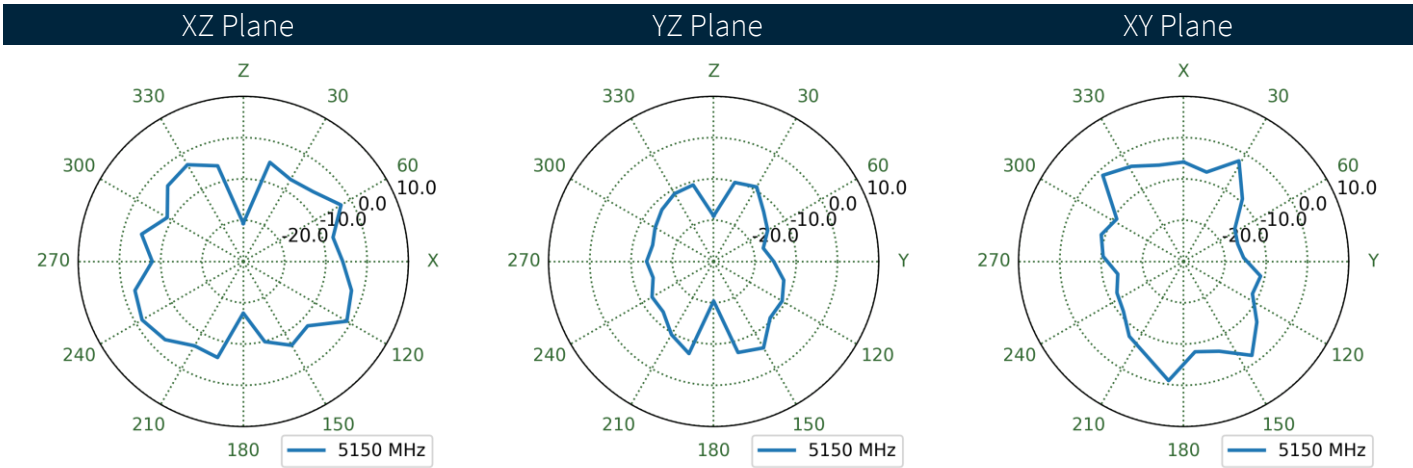
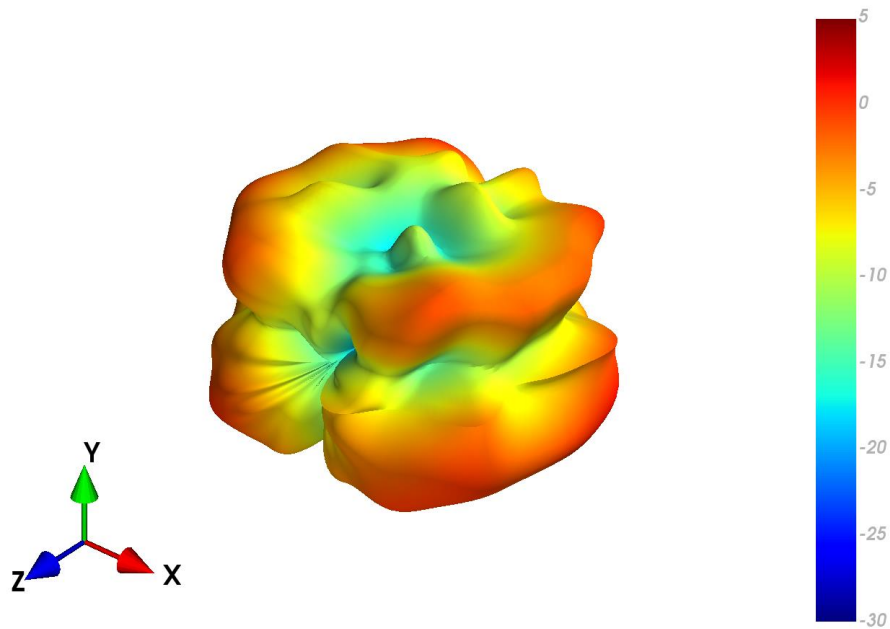

4.15 FXUB63.07.0150C_Chamber Patterns at 5500 MHz

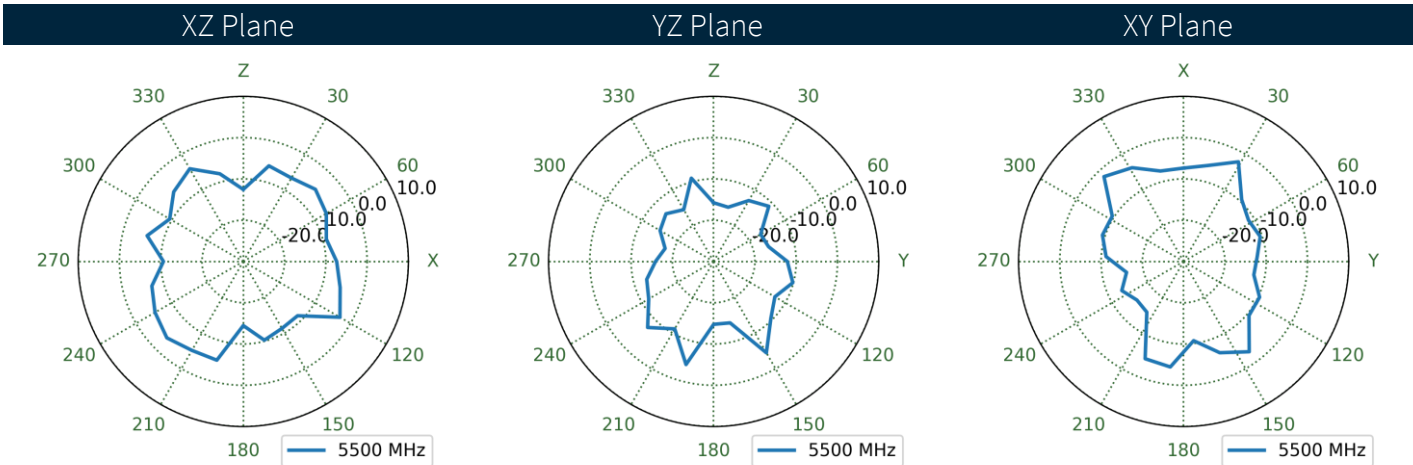
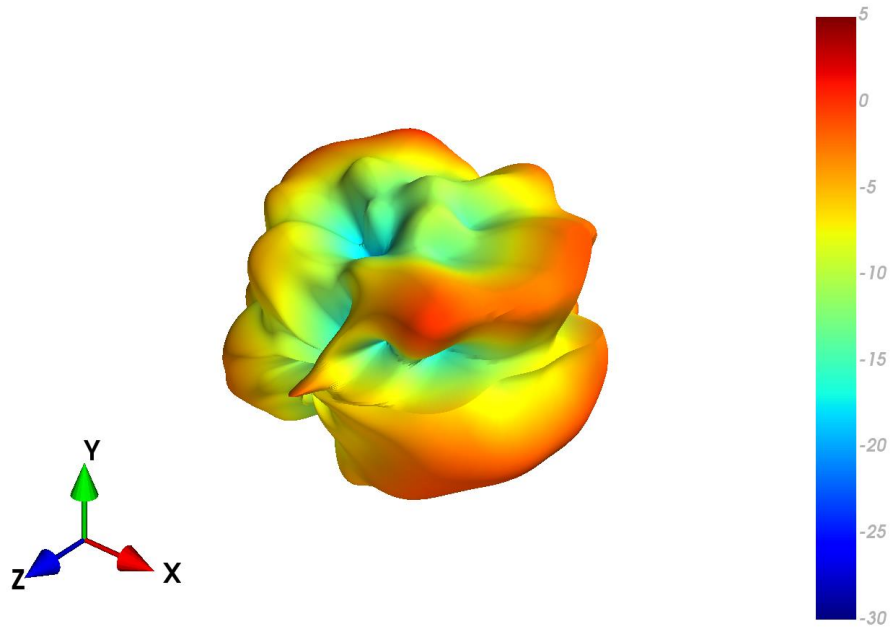

5. Mechanical Drawing

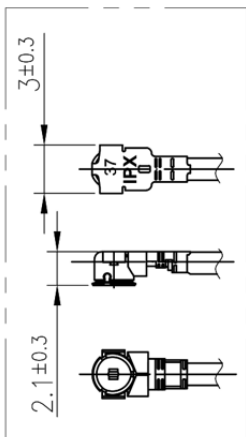
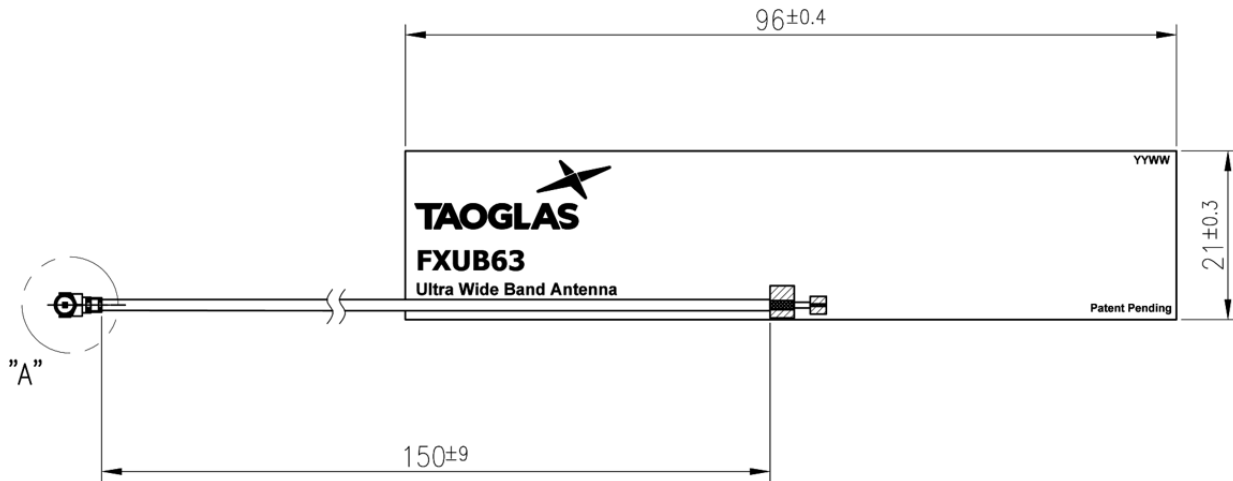

Detail A
Scale:2:1

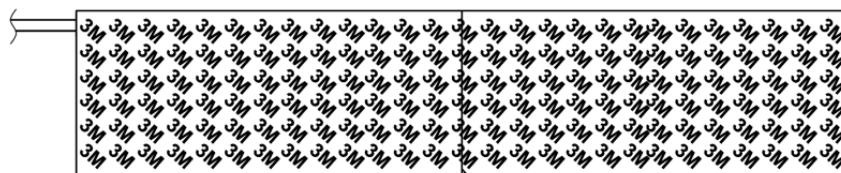
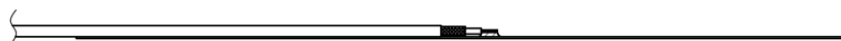

Cutting Line

6. Packaging

100pcs FXUB63.07.0150C per PE Bag
 Dimensions - 300*100
 Weight - 150g

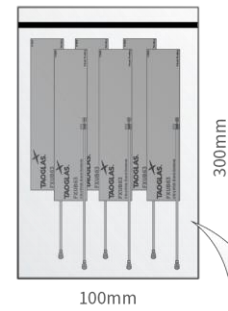

1000pcs FXUB63.07.0150C per Large PE Bag
 Dimensions - 450*280mm
 Weight - 1.5Kg

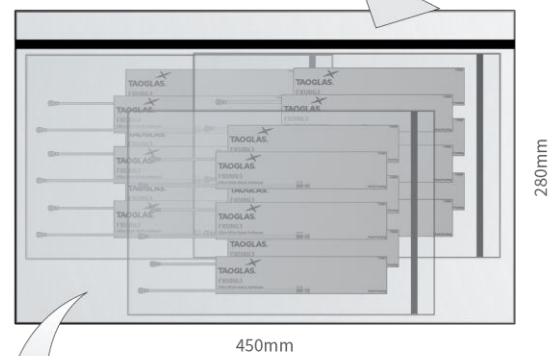

5000pcs FXUB63.07.0150C per carton
 Dimensions - 320*250*230mm
 Weight - 6Kg

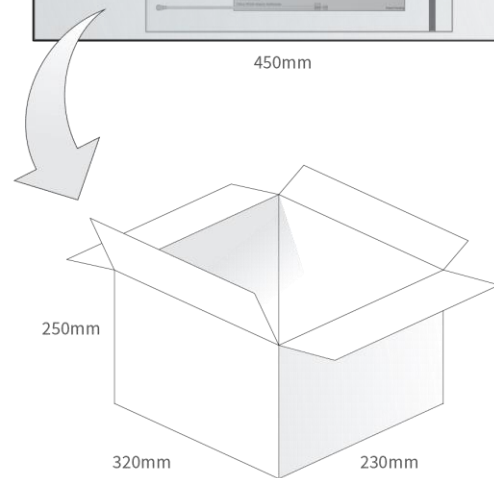

Pallet Dimensions:
 1100*1100*1300mm
 65 Cartons Per Pallet
 13 Cartons Per Layer
 5 Layers

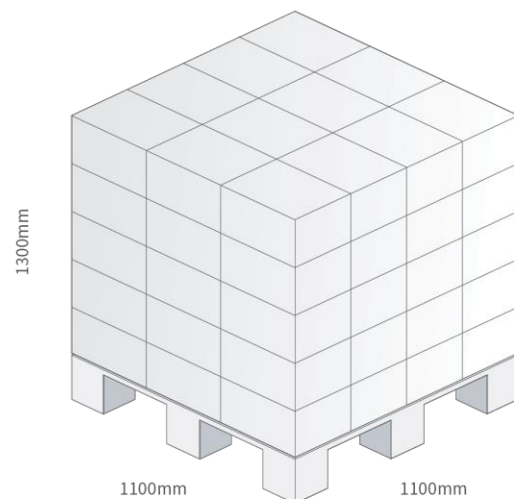

Changelog for the datasheet

SPE-14-8-054 – FXUB63.07.0150C

Revision: G (Current Version)

Date:	2022-12-06
Notes:	Retest 600-6000MHz, Full datasheet update.
Author:	Gary West

Previous Revisions

Revision: F

Date:	2021-07-16
Notes:	Updated Mechanical Drawing
Author:	Gary West

Revision: A (Original First Release)

Date:	2014-05-28
Notes:	First Release
Author:	Jack Conroy

Revision: E

Date:	2021-02-12
Notes:	Updated RF Data and Datasheet Template.
Author:	Gary West

Revision: D

Date:	2019-12-15
Notes:	Updated Images Reference ECR-18-8-259
Author:	Russell Meyler

Revision: C

Date:	2017-05-07
Notes:	Updated as per PCN
Author:	Andy Mahoney

Revision: B

Date:	2017-04-05
Notes:	Updated as per PCN request
Author:	Andy Mahoney



www.taoglas.com



Mouser Electronics

Authorized Distributor

Click to View Pricing, Inventory, Delivery & Lifecycle Information:

[Taoglas:](#)

[FXUB63.07.0150C](#)